

EYQUEM

BOUGIE D'ALLUMAGE - DE PRÉCHAUFFAGE
SPARK PLUGS - GLOW PLUGS

ZÜNDKERZEN - GLÜHKERZEN

BUJIAS DE ENCENDIDO Y DE CALENTAMIENTO



Spark plugs / Bougies d'allumage Zündkerzen / Bujías de encendido

Contents / Sommaire

Inhalt / Contenido

New spark plugs <i>Nouvelles bougies d'allumage</i> Neue Zündkerzen Nuevas bujías de encendido	6
Blister range <i>Gamme blisters</i> SB-Verpackungssortiment Gama blister	8
Eyquem spark plugs identification <i>Identification des bougies Eyquem</i> Bezeichnung der Eyquem Zündkerzen Identificación de las bujías Eyquem	11
Technical characteristics <i>Caractéristiques techniques</i> Technische Informationen Características técnicas	21
Applications by vehicle <i>Applications par véhicule</i> Verwendungen nach Fahrzeugtyp Aplicaciones por vehículo	33
Applications by spark plug <i>Applications par bougie</i> Verwendungen nach Zündkerze Aplicaciones por bujía	253
Cross references <i>Correspondances</i> Umschlüsselungen Referencias cruzadas	257
Suppressions and replacements <i>Suppressions et remplacements</i> Gelöscht und ersetzt Cancelado y reemplazo	279
Spark plug diagnostic <i>Diagnostic bougies</i> Zündkerzendiagnose Diagnóstico bujías	283

Key / Légende Schlüssel / Legenda

F3-1

HIGH PERFORMANCE RANGE
GAMME HAUTE PERFORMANCE

HOCHLEISTUNGSSORTIMENT
EXTENSAO ALTADESEMPEHO
GAMAALTO RENDIMENTO
NAJWYŻSZA TECHNOLOGIA
ΜΠΟΥΖΙ ΥΨΗΛΩΝ ΕΠΙΔΟΣΕΩΝ
ΥΨΗΛΕΣ ΠΕΡΦΟΡΜΑΝΣ ΣΕΡΪΣ
ASORTIMAN VISOKE UČINKOVITOSTI
SORTIMENT PRO VYSOKÝ VÝKON
ЛИНИЯ "HIGH PERFORMANCE"
GAMA ĪNALTĀ PERFORMANĀ
MAGAS TELJESITMENY TERMÉK SKĀLA
ВИСОКОКАЧЕСТВЕНА ТЕХНОЛОГИЯ



MANUFACTURER/MODEL
CONSTRUCTEUR/MODELE

HERSTELLER/MODELL
FABRICANTE/MODELO
PRODUTTORE/MODELLO
FABRICANTE/MODELO
PRODUCENT / MODEL
ΚΑΤΑΣΚΕΥΑΣΤΗΣ/ΤΥΠΟΣ
VÝROBCE/MODEL
ĪRETICI /MODEL
PROIZVOĐAŠĆ/MODEL
PRODUCĀTOR/MODEL
ПРОИЗВОДИТЕЛ/МОДЕЛ
ПРОИЗВОДИТЕЛЬ/МОДЕЛ



PISTON DISPLACEMENT
CYLINDRE

HUBRAUM
DESPLAZAMIENTO DEL PISTÓN
CILINDRATA
MOVIMENTO DO ĒMBOLO
POJEMNOŚĆ SKOKOWA
ΚΥΒΙΚΑ ΕΚΑΤΟΣΤΑ ΚΙΝΗΤΗΡΑ
ZDVINOVÝ OBJEM VĀLCŮ
SĪLĪNDĪR ĪNACĪ
ZAPREMNINA MOTORA
CAPACITATE CILINDRICA
КУБАТУРА
ОБЪЕМ ДВИГАТЕЛЯ



ENGINE
MOTEUR

MOTOR
MOTOR
MOTORE
MOTOR
SILNIK
ΚΙΝΗΤΗΡΑΣ
MOTOR
MOTOR TĪPI
TĪP MOTORA
MOTOR
ДВИГАТЕЛ
ДВИГАТЕЛЬ



Cyl.

CYLINDERS
CYLINDRES

ZYLINDER
CILINDROS
CILINDRATA
CILINDROS
CYLINDER
ΚΥΛΙΝΔΡΟΙ
VÁLCE
SİLİNDİR SAYISI
BROJ CILINDARA
CILINDRI
ЦИЛИНДРИ
ЦИЛИНДРЫ



YEAR OF PRODUCTION
ANNEE DE FABRICATION

BAUJAHR
AÑO DE PRODUCCIÓN
ANNO DI FABBRICAZIONE
ANO DE PRODUÇÃO
ROK PRODUKCI
ΕΤΟΣ ΚΑΤΑΣΚΕΥΗΣ
ROK VÝROBY
ÛRETİM YILI
GODINA PROIZVODNJE
ANUL FABRICAȚIEI
ГОДИНА НА ПРОИЗВОДСТВО
ГОД ВЫПУСКА



CROSS REFERENCE LIST
Liste de correspondances

WETTBEWERBER-TYPE
CÓDIGO DE PRODUCTOS RIVALES
CODICE CONCORRENZA
CÓDIGO DE PRODUTO CONCORRENTE
OZNACZENIE INNEGO PRODUCENTA
ΚΩΔΙΚΟΣ ΑΝΤΑΓΩΝΙΣΤΟΥ
KÓD KONKURENCNÍHO VÝROBKU
RAKİP PARÇA NUMARALARI
KONKURENTSKA ŠIFRA
COD PRODUSE CONCURRENTE
КОНКУРЕНТЕН ПРОДУКТОВ КОД
НОМЕР КОНКУРЕНТНОЙ ПРОДУКЦИИ

Glow plugs / Bougies de préchauffage Glühkerzen / Bujias de calentamiento

Contents / Sommaire

Inhalt / Contenido

New references

Nouvelles références

Neue Type
Nuevas referencias

299

Technical characteristics

Caractéristiques techniques

Technische Informationen
Características técnicas

307

Applications by brand and by vehicle

Applications par marque et par véhicule

Verwendungen nach Fahrzeugtyp
Aplicaciones por marca y vehículo

311

Cross references

Correspondances

Umschlüsselungen
Referencias cruzadas

433

Technical characteristics. Inside cover

Caractéristiques techniques.

À l'intérieur de la couverture

Technische Informationen. Umschlaginnenseite
Características técnicas. Interior de la cubierta

452

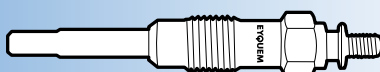

EYQUEM

SPARK PLUGS CATALOGUE

CATALOGUE DE BOUGIES

D'ALLUMAGE

ZÜNDKERZENKATALOG

CATÁLOGO DE BUJIAS

DE ENCENDIDO



5

EYQUEM

New spark plugs / Nouvelles bougies d'allumage

Neue Zündkerzen / Nuevas bujías de encendido

		Short ref	 
RZC 62 HSET	A526	HYUNDAI	i20, i30
		KIA	CARENS III, CEE'D, CERATO, PRO CEE'D, RIO III, SOUL, SPORTAGE, VENG
RWC 58 HSEW	A530	RENAULT	CLIO IV
		DACIA	LOGAN II, SANDERO II
RZN 32 HSWDP	A531	CITROËN	C1 II, C3 II, C4 CACTUS, C-ELYSEE, DS3
		PEUGEOT	2008, 208, 301, 308 II
RFN 42 LZG	A532	ALFA	159
		CHEVROLET	AVEO
		FIAT	CROMA, STILO
		OPEL	AGILA, ASTRA G, ASTRA H, ASTRA J, COMBO, CORSA C, CORSA D, INSIGNIA, MERIVA, MERIVA B, SIGNUM, TIGRA, VECTRA C, ZAFIRA A, ZAFIRA B
RZC 58 HST	A533	HYUNDAI	i10, i20
		KIA	PICANTO, RIO III
RFN 58 HZ5	A534	CITROËN	C1
		DAIHATSU	SIRION
		MITSUBISHI	COLT VI
		PEUGEOT	107
		TOYOTA	AYGO, YARIS
RZC 82 LSDPT	A535	ALFA-ROMEO	GIULIETTA, MITO
		FIAT	500, BRAVO II, DOBLO, LINEA, PUNTO, PUNTO EVO
		LANCIA	DELTA III
RZC 82 HSDPS	A536	FIAT	500, PANDA, PUNTO
FN 72 HZIPRSO	A537	AUDI	A1, A3, A4, A5, A6, Q5, TT
		SEAT	LEON
		SKODA	OCTAVIA
		VW	GOLF VII
ZN 62 LSDPFRSO	A538	AUDI	A1, A3, Q3
		SEAT	IBIZA V, LEON, Mii
		SKODA	CITIGO, FABIA, OCTAVIA, RAPID, SUPERB, YETI
		VW	BEETLE, CADDY IV, CC, GOLF Sportsvan, GOLF VI, GOLF VII, JETTA IV, LOAD UP, PASSAT, POLO, SCIROCCO, SHARAN, TIGUAN, TOURAN, UP
RFN 58 LZDPE5	A539	BMW	1, 3, 5, 6, 7, X1, X5, Z4
RXN 72 HSDPFT	A540	BMW	1, 2, 3, 4, 5, 6, 7, X1, X3, X4, X5, X6, Z4
RXN 72 HSIPFS	A541	CITROËN	BERLINGO, C3 II, C3 PICASSO, C4 CACTUS, C4 GRAND PICASSO II, C4 II, DS3, DS4, DS4 CROSSBACK
		PEUGEOT	2008, 208, 3008, 308 II, 5008
RWN 42 HSIPS	A542	DACIA	DOKKER, DUSTER, LODGY, LOGAN II, LOGAN MCV II, SANDERO II
		NISSAN	JUKE, PULSAR, QASHQAI II
		RENAULT	CAPTUR, CLIO IV, GRAND SCENIC III, KADJAR, MEGANE III, SCENIC III
FC 52 LZWR	A543	MERCEDES	CLASS A, CLASS B
RWN 42 HSIPW	A544	LEXUS	CT 200h
		TOYOTA	AURIS, AVENSIS, IQ, PRIUS, PRIUS PLUS, RAV 4 III, RAV 4 IV, URBAN CRUISER, VERSO, YARIS
RFN 52 HZ5	A545	HYUNDAI	ix35, SANTA FE II
		KIA	MAGENTIS, SORENTO II, SPORTAGE
		NISSAN	ALMERA II, TINO, PRIMERA, X-TRAIL

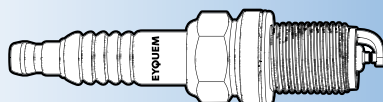

New spark plugs / Nouvelles bougies d'allumage

Neue Zündkerzen / Nuevas bujías de encendido



Short ref



FN 68 LZIFRS	A548	AUDI	A1, A3
		SEAT	ALTEA, IBIZA IV, LEON, TOLEDO
		SKODA	FABIA II, OCTAVIA II, RAPID, ROOMSTER, YETI
		VW	BEETLE, CADDY III, GOLF Plus, GOLF VI, JETTA IV, POLO, TOURAN
RXN 72 HSIPFSO	A550	BMW	1, 2, 3, 4, 5, 7, X1
		MINI	MINI (F54), MINI (F55), MINI (F56), MINI (F57), MINI (F60)
FN 72 LZIFRS	A551	AUDI	A1
		SEAT	ALHAMBRA, IBIZA IV, IBIZA IV SPORTCOUPE, IBIZA IV ST
		SKODA	FABIA II
		VW	BEETLE, EOS, GOLF PLUS, GOLF V, GOLF VI, JETTA III, JETTA IV, PASSAT, POLO, SIROCCO, SHARAN, TIGUAN, TOURAN
RZC 68 HS2	A552	SMART	SMART CABRIO, CITY COUPE, FORTWO CABRIO, FORTWO COUPE, ROADSTER, ROADSTER BRABUS, ROADSTER COUPE, ROADSTER COUPE BRABUS
RWC 42 HSEW	A555	RENAULT	TWINGO III
		DACIA	LOGAN II, SANDERO II
		NISSAN	MICRA V



Blister range / Gamme blister

SB-Verpackungssortiment / Gama blister

Short ref	EYQUEM	Internal Code	EAN Code
B1	C 52 LS	0 910 004 001	3 760 107 902 825
B2	C 62 LJS	0 910 004 017	3 760 107 902 832
B3	C 32 S	0 910 004 004	3 760 107 902 849
B5	C 62 LS	0 910 004 018	3 760 107 902 856
B6	C 82 LS	0 910 004 016	3 760 107 902 863
B7	C 42 S	0 910 004 020	3 760 107 902 870
B9	FC 52 LS	0 910 004 005	3 760 107 903 280
B13	RC 62 LS 5	0 910 004 054	3 760 107 903 358
B14	FC 42 LS	0 910 004 006	3 760 107 902 887
B15	C 62 LS 3X	0 910 004 049	3 760 107 902 894
B16	RFC 52 LS	0 910 004 041	3 760 107 902 900
B17	RC 62 LS	0 910 004 021	3 760 107 902 917
B19	RC 32 LS	0 910 004 007	3 760 107 902 924
B20	RC 52 LS	0 910 004 003	3 760 107 902 931
B23	RC 42 S	0 910 004 023	3 760 107 902 955
B24	RFC 52 LS 5	0 910 004 025	3 760 107 902 962
B25	C 52 LS 3X	0 910 004 035	3 760 107 902 979
B26	RC 72 LS	0 910 004 022	3 760 107 902 986
B27	RC 52 LJS	0 910 004 024	3 760 107 902 993
B28	RFN 58 LZ	0 910 004 051	3 760 107 903 006
B29	RFC 58 LZK	0 910 004 048	3 760 107 903 013
B30	RFC 42 LZ 2E	0 910 004 050	3 760 107 903 020
B31	RFC 58 LZ 2E	0 910 004 039	3 760 107 903 037
B33	RFC 58 LS 3	0 910 004 008	3 760 107 903 044
B38	RC 52 LS 5	0 910 004 002	3 760 107 903 051
B48	RFC 58 LS 5	0 910 004 026	3 760 107 903 068
B50	RFN 52 HZ	0 910 004 042	3 760 107 903 075
B53	RC 62 HJSP	0 910 004 043	3 760 107 903 082
B54	RC 58 LZ 3EX	0 910 004 044	3 760 107 903 099
B55	RFC 58 LZ 3EX	0 910 004 045	3 760 107 903 105
B56	RC 52 LJS 5	0 910 004 046	3 760 107 903 112
B57	RC 62 HJS 6	0 910 004 047	3 760 107 903 129
B58	RWC 52 HSK	0 910 004 168	3 760 107 904 591
B59	RZC 58 LS	0 910 004 169	3 760 107 904 607

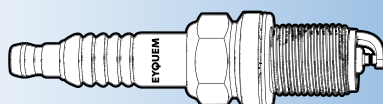

H.V. TERMINAL NUT
ECROU DE CONNEXION
KABELSTECKMUTTER
CONEXIÓN ALTA TENSIÓN
CAPOCORDA A DADO
KABELINSTECKMOER
TARRAXA DE LIGACAO
ŁĄCZNIK PRZEWODU
AKPO ΣΥΝΔΕΣΗΣ
KABELOVÁ NÁSTRČKA
VYSOKONAPĚTŮVÉHO TERMINÁLU
MAGAS FESZÜLTSGŰ RÉZ
CSATLAKOZÓ
YÜKSEK VOLTAJA DAYANIKLI SOMUN

ALUMINA INSULATOR
ISOLANT
ISOLATOR AUS ALUOXYD
AISLADOR
ISOLATORE DI OSSIDO DI ALUMINIO
ISOLATOR
ISOLANTE
IZOLATOR
ΜΟΝΩΤΗΡΑΣ ΑΠΟ ΠΟΡΣΕΛΑΝΗ
IZOLÁTOR Z OXIDU HLINITÉHO
ALUMÍNIUM_OXID SZIGETELÉS
IZOLÁTOR

NICKEL-PLATED SHELL
CULOT DE BOUGIE NICKELE
VERNICKELTER KERZENKÖRPER
CASCO NIQUELADO
CORPO CANDELA NICHELATO
VERNIKKELD BOUGIEHUIS
CANHAO DE VELA
KORPUS NIKLOWANY
ΜΕΤΑΛΛΙΚΟ ΕΠΙΝΙΚΕΛΩΜΕΝΟ ΣΩΜΑ
PONIKLOVANÉ TĚLO SVÍČKY
NIKKELEZETT BURKOLAT
NÍKEL KARLAMA METAL KABUK

EXTERNAL GASKET
JOINT EXTERIEUR
ÄUSSERER DICHRING
JUNTA EXTERIOR
ANELLO DI TENUTA ESTERNO
EXTERNE PAKKINGRING
JUNTA EXTERIOR
USZCZELKA ZEWNĘTRZNA
ΕΞΩΤΕΡΙΚΗ ΡΟΔΕΛΑ
VNĚJŠÍ TĚSNÍČÍ KROUŽEK
KÜLSŐ TÖMÍTÉS
DIŞ CONTA (PUL)

CENTRE ELECTRODE
ELECTRODE CENTRALE
MITTELEKTRODE
ELECTRODO CENTRAL
ELETTRODO CENTRALE
CENTRALE ELEKTRODE
ELECTRODO CENTRAL
ELEKTRODA CENTRALNA
ΚΕΝΤΡΙΚΟ ΗΛΕΚΤΡΟΔΙΟ
STŘEDOVÁ ELEKTRODA
KÖZPONTI ELEKTRODA
ORTA ELEKTROD

TERMINAL POST
VIS TERMINALE
ZÜNDSTIFT
TUERCA DE CONEXIÓN
PERCUSSORE
MIDDENELEKTRODE
PARAFUSO FINAL
WKŁAD POŁĄCZENIOWY
AKPO ΣΤΕΛΕΞΟΥΣ
ZAPALOVACÍ ELEKTRODA
RÉZ CSATLAKOZÓ VÉGZÖDÉS
UÇ BALANTISI

CONDUCTIVE SEALING
CIMENT CONDUCTEUR
LEITENDE GLASSCHMELZE
SELLO INTERNO
VETRO FUSO CONDUCENTE
ELEKTRISCH GELEIDENDE GLASCOMPOSITIE
CIMENTO CONDUCTORE
USZCZELNIENIE PRZEWODZĄCE
ΣΤΕΓΑΝΟΣ ΑΓΩΓΟΣ
VODIVÁ SKLENĚNÁ TAVENINA
VEZETŐ ANYAG
ÍLETKEN SABÍTLEYÍCI

INTERNAL GASKET
JOINT INTERIEUR
INNERER DICHRING
JUNTA DE HERMETICIDAD INTERIOR
ANELLO DI TENUTA INTERNO
BINNENSTE PAKKINGRING
JUNTA INTERIOR
USZCZELKA WEWNĘTRZNA
ΕΣΩΤΕΡΙΚΗ ΡΟΔΕΛΑ
VNITŘNÍ TĚSNÍČÍ KROUŽEK
BELSŐ TÖMÍTÉS
İÇ CONTA

GROUND ELECTRODE
ELECTRODE DE MASSE
MASSEELEKTRODE
ELECTRODO DE MASA
ELETTRODO DI MASSA
MASSA-ELEKTRODE
ELECTRODO DE MASSA
ELEKTRODA MASOWA
ΗΛΕΚΤΡΟΔΙΟ ΣΩΜΑΤΟΣ
ZEMNICÍ ELEKTRODA
TESTELEKTRODA
TOPRAK ELEKTRODU (TIRNAK)

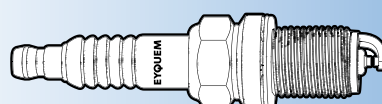

EYQUEM SPARK PLUGS IDENTIFICATION IDENTIFICATION DES BOUGIES EYQUEM

BEZEICHNUNG DER EYQUEM ZÜNDKERZEN
IDENTIFICACIÓN DE LAS BUJÍAS EYQUEM

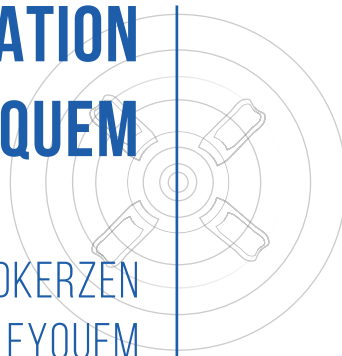

11

Federal-Mogul Ignition Products SAS
Rue Joanny Desage
42140 Chazelles Sur Lyon
France
Phone : +33 (0) 146942719
Fax : +33-(0) 146942780
www.eyquem.com

EYQUEM

Recommendation chart / Guide d'allumage

Anwendungskatalog / Guia de encendido

GB

RECOMMENDATION CHART

This catalogue cancels and replaces all previous issues.

It has been established with the utmost technical strictness.

However, it is not contractual and we cannot be considered liable for any error which may have slipped in.

F

GUIDE D'ALLUMAGE

Ce catalogue annule et remplace toutes les éditions précédentes.

Il a été rédigé avec la plus grande rigueur technique.

Toutefois, il n'est pas contractuel et nous ne saurions être tenus responsables des erreurs qui s'y seraient glissées.

D

ANWENDUNGSKATALOG

Mit Erscheinen dieses Katalogs verlieren alle bisherigen Ausgaben ihre Gültigkeit. Der Katalog ist mit größter Sorgfalt erstellt worden.

Für eventuelle Fehler können wir keine Verantwortung übernehmen.

ES

GUIA DE ENCENDIDO

Este catálogo anula y sustituye a todas las ediciones precedentes.

Ha sido elaborado con un gran rigor técnico.

Sin embargo, teniendo en cuenta que este catálogo no tiene valor de contrato, nuestra responsabilidad no esta comprometida por los errores que pudieran presentarse.

ITA

GUIDA DI ACCENSIONE

Questo catalogo annulla e sostituisce tutte le edizioni precedenti.

È stato redatto con il massimo rigore tecnico.

Ma non è contrattuale e non possiamo essere ritenuti responsabili delle sue eventuali inesattezze.

NL

KATALOGUS

Deze katalogus vervangt de voorgaande en is opgesteld met de grootste zorg.

Voor eventuele weglatingen en vergissingen kunnen wij niet verantwoordelijk worden gesteld.

SLO

Sporočilni del

Ta katalog ukinja in zamenjuje vse prejšnje verzije.

Ustvarjen je bil s pomočjo tehnikov in njihovim znanjem.

Kakorkoli že, ni pogodben in ne smemo smatrati kot odgovornost za katerokoli napako, ki se je pojavila v katalogu.

RO

Recomandări

Acest catalog anulează și înlocuiește toate edițiile precedente

și a fost editat riguros și în concordanță cu datele tehnice ale produselor.

Totuși datele nu au caracter contractual și nu ne asumăm răspunderea pentru eventualele erori.

P

GUIA DE IGNIÇÃO

Este catálogo anula e substitui todas as edições precedentes.

Foi redigido com o maior rigor técnico. Todavia, não envolve qualquer responsabilidade contractual e não nos responsabilizamos por qualquer erro que passa eventualmente apresentar.

PL

KATALOG

Katalog ten anuluje i zastępuje wszystkie poprzednie edycje.

Został on zredagowany przy zachowaniu najwyższej dokładności technicznej. Za ewentualne błędy powstałe podczas druku nie ponosim odpowiedzialności.

GR

ΚΑΤΑΛΟΓΟΣ ΕΦΑΡΜΟΓΩΝ

Ο Ι αρών κατάλογος ακυρώνει και αντικαθιστά κάθε Ι ροηγούμενο.

Για την έκδοσή του, Ι ραγματοί οιήθηκε ένας διεξοδικός τεχνικός έλεγχος. Η εταιρία μας δεν φέρει καμιά ευθύνη για ενδεχόμενη ύι αρξη τυι ογραφικών λαίων.

CZ

APLIKAČNÍ TABULKA

Tento katalog ruší platnost a zároveň nahrazuje všechny předchozí vydání. Byl vytvořen s co největší přesností

technických údajů. I přesto není smluvně zaručena správnost a naše strana nemůže odpovídat za chybu, která by se mohla objevit.

H

ÚTMUTAO TÁBLÁZAT

Ez a katalógus az összes előző kiadások helyébe lép és törli azokat. A

lehető legnagyobb műszaki pontossággal készült, az esetleges nyomdahibákért azonban nem tudunk felelősséget vállalni.

TR

ÜRÜN KATALOGU

Bu katalog daha önce basılan bütün katalogların yerini alır ve eski

baskıların hükmü yoktur. Çok dikkatli bir teknik çalışıma sonunda hazırlanmıştır. Ancak katalog bağlayıcı değildir ve içeriğinde olabilecek hatalardan dolayı firmamız sorumlu tutulamaz.

HR

Tabela primjene

Ovaj katalog poništava i zamjenjuje sve prijašnje verzije.

Izrađen je s maksimalnom tehničkim znanjem.

Međutim ne predstavlja pravni dokument i ne možemo preuzeti odgovornost za eventualnu pogrešku.

Eventualne pogreške su slučajne i nenamjerne.

BG

ПРЕПОРЪКИ

Този каталог анулира и замества всички предишни издания.

Той беше изготвен с най-голяма техническа точност.

Все пак, той не е договор и ние не можем да бъдем считани за отговорни за грешки, които може би са се промъкнали вътре.

GB • EYQUEM PLUGS IDENTIFICATION

R	F	C	42	L	Z	2	E
Resistor No letter no resistor R from 3 to 9 KΩ		Electrodes material No letter Nickel range Nickel centre and ground electrodes C Super range copper cored centre electrode Nickel ground electrode N Super range Copper cored centre & ground electrodes		Thread reach Taper seat Flat seat No letter 11,2 12,7 A 11,1 C 7,8 9,5 L 17,5 19 H 25 26,5		Nose projection - insulator / shell No letter from 0,5 to 2,7 mm E from 2,71 to 3,8 mm G 3,81 mm and more	
Shell type Ø mm thread Spanner mm No letter Flat seat M14 x 1,25 or Taper seat M14 x 1,25 D M12 x 1,25 18 Z M12 x 1,25 16 W M12 x 1,25 14 F M14 x 1,25 16 K M18 x 1,50 21 T M10 x 1,00 16 X M12 x 1,25 Bi-Hex		Heat range Super range 12 hot 22 ↑ 28 30 32 42 52 56 58 62 72 82 92 96 99 ↓ ... cold Nickel/Chrome range from 200 hot to 1200 cold		Shell seat No letter flat seat J taper seat		Other features 0,6 mm > gap S 0,7 mm gap T 0,8 mm gap W 0,9 to 1,0 mm gap 5 1,1 to 1,2 mm gap 6 1,3 mm gap 7 1,5 mm gap Z 2,0 mm gap P 1 Electrode with platinum tip (centre or ground) DP Platinum tipped centre and ground electrodes I 1 Electrode with iridium tip (centre or ground) DI Iridium tipped centre and ground electrodes IP Iridium tipped on centre electrode and Platinum tipped on ground electrode PI Platinum tipped on centre electrode and Iridium tipped on ground electrode X Compact (chain saw, lawn mower) T Reinforced electrodes K Specific options W Large lug glow plug (except LS 3X plugs) V Shell with ground electrode single-bloc machined F Skirt above 1 mm A Plug with standard ground electrode + Auxiliary side ground electrode(s) R from 1 to 2 KΩ	
		Type of insulator nose No letter not projected S projected Z projected & anti-fouling feature		Position and number of ground electrode(s) No letter 1 ground electrode Conventional position 2 2 side ground electrodes 3 3 side ground electrodes 4 4 side ground electrodes			

F • IDENTIFICATION DES BOUGIES EYQUEM

R	F	C	42	L	Z	2	E
Resistor Rien sans R 3 à 9 KΩ		Electrodes material Rien Gamme Nickel électrode centrale et de masse nickel C Gamme Super électrode centrale Bi-métal Nickel+Cuivre électrode de masse Nickel N Gamme Super électrode centrale & de masse Bi-métal Nickel+Cuivre		Longueur culot siège conique siège plat Rien 11,2 12,7 A 11,1 C 7,8 9,5 L 17,5 19 H 25 26,5		Projection du bec - isolant/culot Rien 0,5 à 2,7 mm E 2,71 à 3,8 mm G 3,81 mm et plus	
Type Culot Ø filetage Dim. clé sur plats Rien S/plat M14 x 1,25 ou S/conique M14 x 1,25 16 D M12 x 1,25 18 Z M12 x 1,25 16 W M12 x 1,25 14 F M14 x 1,25 16 K M18 x 1,50 21 T M10 x 1,00 16 X M12 x 1,25 Bi-Hex		Indice thermique Gamme Super 12 chaud 22 ↑ 28 30 32 42 52 56 58 62 72 82 92 96 99 ↓ ... froid Gamme Nickel/chrome de 200 chaud à 1200 froid		Siège culot Rien plat J conique		Autres caractéristiques 0,6 mm > écartement S Ecartement 0,7 mm T Ecartement 0,8 mm W Ecartement 0,9 - 1,0 mm 5 Ecartement 1,1 - 1,2 mm 6 Ecartement 1,3 mm 7 Ecartement 1,5 mm Z Ecartement 2,0 mm P 1 Electrode à pointe platine (centrale ou de masse) DP Electrodes centrale et de masse à pointe platine I 1 Electrode à pointe iridium (centrale ou de masse) DI Electrodes centrale et de masse à pointe iridium IP Electrode à pointe iridium centrale et électrode à pointe platine de masse PI Electrode à pointe platine centrale et électrode à pointe iridium de masse T Compacte (tronçonneuse, tondeuse) X Electrodes renforcées K Options spécifiques W Bougies grande saillie (sauf bougies LS 3X) V Culot avec EM taillée dans la masse F Jupe supérieure à 1 mm A Bougie EM standard + EM auxiliaire(s) latérales R 1 à 2 KΩ	
		Position du bec d'isolant Rien non projeté S projeté Z projeté + technologie anti-encrassement		Configuration et nombre d'électrode(s) de masse Rien 1 électrode de masse position standard 2 2 électrodes de masse latérale 3 3 électrodes de masse latérale 4 4 électrodes de masse latérale			

ITA • IDENTIFICAZIONE DELLE CANDELE EYQUEM

R	F	C	42	L	Z	2	E
Resistenza		Materia Elettrodi		Lunghezza del corpo		Proiezione della punta dell'isolante/corpo	
Se mancante	senza	Se mancante	Gamma Nichelio elettrodo centrale e massa in Nichelio	No lettera	sede conica	sede piatta	Se mancante
R	da 3 a 9 KΩ	C	Gamma Super elett. centrale Bi-metallico Nichelio + Rame	A	11,2	12,7	E
		N	Gamma Super elett. centrale Bi-metallico Nichelio + Rame	C	7,8	9,5	G
				L	17,5	19	
				H	25	26,5	
Tipo di Corpo		Grado termico		Sede corpo		Altre caratteristiche	
Se mancante	Ø filettatura	Dim. chiave	Gamma Super	Se mancante	piatta		0,6 mm > distanza elettrodi
	sede piatta M14 x 1,25 o sede conica M14 x 1,25	21	12	J	conica		S Distanza elettrodi 0,7 mm
D	M12 x 1,25	18	22				T Distanza elettrodi 0,8 mm
Z	M12 x 1,25	16	28				W Distanza elettrodi 0,9 - 1,0 mm
W	M12 x 1,25	14	30				5 Distanza elettrodi 1,1 - 1,2 mm
F	M14 x 1,25	16	32				6 Distanza elettrodi 1,3 mm
K	M18 x 1,50	21	42				7 Distanza elettrodi 1,5 mm
T	M10 x 1,00	16	52				Z Distanza elettrodi 2,0 mm
X	M12 x 1,25	Bi-Hex	56				P 1 elettrodo con punta di platino (centrale o di massa)
			58				DP Elettrodo centrale e di massa con punta di platino
			62				I Elettrodo all'iridio (elettrodo centrale o elettrodo di massa)
			72				DI Elettrodo all'iridio (Elettrodo centrale e Elettrodo di massa)
			82				IP Riporto di iridio sull'elettrodo centrale e riporto di platino sull'elettrodo di massa
			92				PI Riporto di platino sull'elettrodo centrale e riporto di iridio sull'elettrodo di massa
			96				T Compatta (sega a motore, tosaerba)
			99				X Elettrodi pesanti
			...				K Opzioni specifiche
			Gamma Nichelio/Chrome				W Candela di accensione a grande sporgenza (salvo le candele LS 3X)
			da 200 a 1200				V Corpo con elettrodo di massa ricavato nella massa
							F Gonna superiore a 1 mm
							A Candela con elettrodo di massa standard + elettrodo(i) di massa ausiliare(i) laterale(i)
							R da 1 a 2 KΩ

NL • IDENTIFICATIE VAN DE EYQUEM BOUGIE (REFERENTIE)

R	F	C	42	L	Z	2	E
Weerstand		Elektrodenmateriaal		Draadlengte		Uitsteeksel isolator draad	
geen letter	geen Weerstand	geen letter	Nikkel bougie centrale en massa-elektrode van nikkel	geen letter	Konische zitting	platte zitting	geen letter
R	van 3 tot 9 KΩ	C	Super bougie central elektrode met koper-kern massa-elektrode van nikkel	A	11,2	12,7	E
		N	Super bougie centrale en massa-elektroden met koper-kern	C	7,8	9,5	G
				L	17,5	19	
				H	25	26,5	
Draadtype		Warmtegraad		Draadzitting		Andere uitvoeringen	
geen letter	Ø Draaddiam	Bougiesleutel	Super bougie	geen letter	plate zitting		0,6 mm > afstand elektroden
	Platte zitting M14 x 1,25 of Konische zitting M14 x 1,25 16	21	12	J	konische zitting		S Afstand elektroden 0,7 mm
D	M12 x 1,25	18	22				T Afstand elektroden 0,8 mm
Z	M12 x 1,25	16	28				W Afstand elektroden 0,9 - 1,0 mm
W	M12 x 1,25	14	30				5 Afstand elektroden 1,1 - 1,2 mm
F	M14 x 1,25	16	32				6 Afstand elektroden 1,3 mm
K	M18 x 1,50	21	42				7 Afstand elektroden 1,5 mm
T	M10 x 1,00	16	52				Z Afstand elektroden 2,0 mm
X	M12 x 1,25	Bi-Hex	56				P 1 elektrode met platina puntje (centrale of massa)
			58				DP Centrale en massa-elektroden met platina puntje
			62				I Elektrode met iridium punt (centraal of massa)
			72				DI Centrale- en massa-elektroden met iridium punt.
			82				IP Centrale elektrode met iridium puntje en massa-elektrode met platina punt
			92				PI Centrale elektrode met platina puntje en massa-elektrode met iridium punt
			96				T Compacte bougie voor zaag- en maaimachines
			99				X Verstevigde elektroden
			...				K Specifieke opties
			Nikkel/Chrome bougie				W Ontstekingsbougie met groot uitsteeksel (behalve LS 3X-bougies)
			van 200 tot 1200				V Voet met aardingsselektrode uit één stuk
							F Mantel dikker dan 1 mm
							A Bougie standaard aardingsselektrode + laterale hulpaardingsselektrodes
							R van 1 tot 2 KΩ

P • IDENTIFICAÇÃO DAS VELAS EYQUEM

R	F	C	42	L	Z	2	E
---	---	---	----	---	---	---	---

Resistência	
Nada	Sem
R	de 3 a 9 KΩ

Materia dos electrodos	
Nada	Gama Níquel Electrodos central e massa níquel
C	Gama Super Electrodo central bimetalico Ni+Cu Electrodo de massa Níquel
N	Gama Super N central e massa bimetalicos (Ni + Cu)

Comprimento do Canhão		
	Sede cônica	Sede plana
Nada	11,2	12,7
A		11,1
C	7,8	9,5
L	17,5	19
H	25	26,5

Projeção do bico isolante/canhão	
Nada	de 0,5 a 2,7 mm
E	de 2,71 a 3,8 mm
G	de 3,81 mm e mais

Outras características	
	0,6 mm > abertura
S	Abertura 0,7 mm
T	Abertura 0,8 mm
W	Abertura 0,9 - 1,0 mm
5	Abertura 1,1 - 1,2 mm
6	Abertura 1,3 mm
7	Abertura 1,5 mm
Z	Abertura 2,0 mm

Tipo de Canhão		Dim C	
	Ø rosca		
Nada	Sede plana M14 x 1,25 ou Sede cônica M14 x 1,25	21	
		16	
D	M12 x 1,25	18	
Z	M12 x 1,25	16	
W	M12 x 1,25	14	
F	M14 x 1,25	16	
K	M18 x 1,50	21	
T	M10 x 1,00	16	
X	M12 x 1,25	Bi-Hex	

Grau Térmico		
Gama Super		
12	Quente ↑	
22		
28		
30		
32		
42		
52		
56		
58		
62		
72	Frio ↓	
82		
92		
96		
99		
...		
Gama Níquel/Chrome de 200 a 1200		
		Quente
		Frio

Sede Canhão	
Nada	plana
J	cônica

Posição do bico de isolante	
Nada	não saliente
S	saliente
Z	saliente & tecnologia anti-encrustamento

Configuração e nome do electrodo(s) de massa	
Nada	1 electrodo de massa Configuração standard
2	2 electrodos de massa laterais
3	3 electrodos de massa laterais
4	4 electrodos de massa laterais

Projeção do bico isolante/canhão	
Nada	de 0,5 a 2,7 mm
E	de 2,71 a 3,8 mm
G	de 3,81 mm e mais

Outras características	
	0,6 mm > abertura
S	Abertura 0,7 mm
T	Abertura 0,8 mm
W	Abertura 0,9 - 1,0 mm
5	Abertura 1,1 - 1,2 mm
6	Abertura 1,3 mm
7	Abertura 1,5 mm
Z	Abertura 2,0 mm

P	1 electrodo com ponta de platina (central ou de massa)
DP	Electrodos central e de massa com ponta de platina
I	1 Electrodo com ponta de iridium (central ou massa)
DI	Ponta de iridium nos electrodos centrais e de massa
IP	Ponta de iridium no electrodo central e de platina no electrodo de massa
PI	Ponta de platina no electrodo central e de iridium no electrodo de massa
T	Compacta (motoserra, máquina de aparar a relva)
X	Electrodos reforçados
K	Opções específicas
W	Vela de ignição cabeça grande (excepto as velas LS 3X)
V	Electrodo de massa integrado à base
F	Saia superior a 1 mm
A	Vela com electrodo de massa standard + electrodo de massa auxiliar(es) lateral(ais) de 1 a 2 KΩ
R	

PL • IDENTYFIKACJA SWIEC EYQUEM

R	F	C	42	L	Z	2	E
---	---	---	----	---	---	---	---

Rezystor	
Bez symbolu	bez rezystora
R	od 3 do 9 KΩ

Materiał elektrody	
Bez symbolu	gama niklowa Elektroda centralna i masowa niklowa
C	gama Super elektroda centralna bi-metalowa Nikiel + Miedz elektroda masowa niklowa
N	gama Super elektroda centralna i masowa bi-metalowa Nikiel + Miedz

Długość trzonu		
	gniazdo stożkowe	gniazdo płaskie
Bez symbolu	11,2	12,7
A		11,1
C	7,8	9,5
L	17,5	19
H	25	26,5

Przekrój izolatora / trzonu świecy	
Bez symbolu	od 0,5 do 2,7 mm
E	od 2,71 do 3,8 mm
G	3,81 mm i więcej

Inne informacje	
	0,6 mm > odstęp
S	odstęp 0,7 mm
T	odstęp 0,8 mm
W	odstęp 0,9 - 1,0 mm
5	odstęp 1,1 - 1,2 mm
6	odstęp 1,3 mm
7	odstęp 1,5 mm
Z	odstęp 2,0 mm

Typ trzonu świecy		Wskaźnik ciepłoty	
	Ø gwintu		
Bez symbolu	gniazdo płaskie M14 x 1,25 lub stożkowe M14 x 1,25	21	gorąco ↑
		16	
D	M12 x 1,25	18	
Z	M12 x 1,25	16	
W	M12 x 1,25	14	
F	M14 x 1,25	16	
K	M18 x 1,50	21	
T	M10 x 1,00	16	
X	M12 x 1,25	Bi-Hex	
		14mm 5/8	

Gniazdo trzonu	
Bez symbolu	płaskie
J	stożkowe

Typ izolatora	
Bez symbolu	zgrzewany
S	zgrzewany
Z	zgrzewany i polerowany + technologia samooczyszczania

Konfiguracja i liczba elektrod masowych	
Bez symbolu	1 elektroda masowa, pozycja standardowa
2	2 elektrody masowe, boczne
3	3 elektrody masowe, boczne
4	4 elektrody masowe, boczne

Inne informacje	
	0,6 mm > odstęp
S	odstęp 0,7 mm
T	odstęp 0,8 mm
W	odstęp 0,9 - 1,0 mm
5	odstęp 1,1 - 1,2 mm
6	odstęp 1,3 mm
7	odstęp 1,5 mm
Z	odstęp 2,0 mm

P	1 elektroda platynowa (masowa lub centralna)
DP	elektrody centralne i masowe platynowe
I	Irydowe zakończenia elektrody centralnej lub bocznej
DI	Irydowe zakończenia elektrody centralnej i bocznej
IP	Irydowe zakończenie elektrody centralnej i platynowe zakończenie elektrody bocznej
PI	Platynowe zakończenie elektrody centralnej i irydowe zakończenie elektrody bocznej
T	zwarta (pila łańcuchowa, kosiarka)
X	elektrody wzmocnione
K	Opcje specyficzne
W	Świeca zapłonowa z Dużym występem (oprócz świec LS 3X)
V	Korpus z Elektroda masową naciętą w masie
F	Osłona górna 1 mm
A	Świeca ze standardową Elektroda masową + pomocniczą boczną Elektroda masową
R	od 1 do 2 KΩ

HU • GÜYJTÖGYERTYA AZONOSLTÁS

R	F	C	42	L	Z	2	E																											
Rádiózávarsűrő Betűnélkül Nincsrá diózávarsűrő R 3 - 9 KΩ		Electrodes material Betűnélkül Nikkel gyújtógyertya : Nikkel központi- és t estelektóda C Szuper gyújtógyertya : Réz-és nikkel központi elektóda Nikkel testelektóda N Szuper gyújtógyertya : Réz-és nikkel központi – és testelektóda		Gyertyatest hossza <table border="1"> <thead> <tr> <th>Üres</th> <th>Kúpos felfekvés</th> <th>Alátétes felfekvés</th> </tr> </thead> <tbody> <tr> <td>A</td> <td>11,2</td> <td>12,7</td> </tr> <tr> <td>C</td> <td>7,8</td> <td>9,5</td> </tr> <tr> <td>L</td> <td>17,5</td> <td>19</td> </tr> <tr> <td>H</td> <td>25</td> <td>26,5</td> </tr> </tbody> </table>		Üres	Kúpos felfekvés	Alátétes felfekvés	A	11,2	12,7	C	7,8	9,5	L	17,5	19	H	25	26,5	Szigetelő csúcs kiálló hossza <table border="1"> <thead> <tr> <th></th> <th>0,5 - 2,7 mm</th> </tr> </thead> <tbody> <tr> <td>E</td> <td>2,71 - 3,8 mm</td> </tr> <tr> <td>G</td> <td>3,81 mm és annál több</td> </tr> </tbody> </table>			0,5 - 2,7 mm	E	2,71 - 3,8 mm	G	3,81 mm és annál több						
Üres	Kúpos felfekvés	Alátétes felfekvés																																
A	11,2	12,7																																
C	7,8	9,5																																
L	17,5	19																																
H	25	26,5																																
	0,5 - 2,7 mm																																	
E	2,71 - 3,8 mm																																	
G	3,81 mm és annál több																																	
Burkolat típusa <table border="1"> <thead> <tr> <th>Betűnélkül</th> <th>Ø Atméro mm</th> <th>Gyertyakulcs méret mm</th> </tr> </thead> <tbody> <tr> <td>D</td> <td>M12 x 1,25</td> <td>18</td> </tr> <tr> <td>Z</td> <td>M12 x 1,25</td> <td>16</td> </tr> <tr> <td>W</td> <td>M12 x 1,25</td> <td>14</td> </tr> <tr> <td>F</td> <td>M14 x 1,25</td> <td>16</td> </tr> <tr> <td>K</td> <td>M18 x 1,50</td> <td>21</td> </tr> <tr> <td>T</td> <td>M10 x 1,00</td> <td>16</td> </tr> <tr> <td>X</td> <td>M12 x 1,25</td> <td>Bi-Hex</td> </tr> </tbody> </table>		Betűnélkül	Ø Atméro mm	Gyertyakulcs méret mm	D	M12 x 1,25	18	Z	M12 x 1,25	16	W	M12 x 1,25	14	F	M14 x 1,25	16	K	M18 x 1,50	21	T	M10 x 1,00	16	X	M12 x 1,25	Bi-Hex	Hőérték Szuper Gyújtógyertya 12 Forró 22 ↑ 28 30 32 42 52 56 58 62 72 82 92 96 99 ... Hideg Nikkel/ Króm gyújtógyertya de 200 Forró à 1200 Hideg		Felfekvő felület formája <table border="1"> <thead> <tr> <th>Üres</th> <th>Alátétes</th> </tr> </thead> <tbody> <tr> <td>J</td> <td>Kúpos</td> </tr> </tbody> </table>		Üres	Alátétes	J	Kúpos	
Betűnélkül	Ø Atméro mm	Gyertyakulcs méret mm																																
D	M12 x 1,25	18																																
Z	M12 x 1,25	16																																
W	M12 x 1,25	14																																
F	M14 x 1,25	16																																
K	M18 x 1,50	21																																
T	M10 x 1,00	16																																
X	M12 x 1,25	Bi-Hex																																
Üres	Alátétes																																	
J	Kúpos																																	
		Szigetelő csúcs típusa Üres Nem kiálló S Kiálló Z Kiálló lerakódásgátló bevonattal		Autres caractérisques 0,6 mm > gyertyahézag S 0,7 mm gyertyahézag T 0,8 mm gyertyahézag W 0,9 - 1,0 mm gyertyahézag 5 1,1 - 1,2 mm gyertyahézag 6 1,3 mm gyertyahézag 7 1,5 mm gyertyahézag Z 2,0 mm gyertyahézag																														
		Testelektórák helyzete és száma Nincs betű 1 testelektóda Alap típus 2 2 pólusú testelektóda 3 3 pólusú testelektóda 4 4 pólusú testelektóda		Autres caractérisques P 1 elektróda platina csúccsal (központi vagy test) DP Platina csúccsal központi-és testelektóda I 1 Iridium elektróda csúcs (föld vagy középső) DI Középső és föld elektróda Iridium csúccsal IP Iridium csúcs a középső és Platina csúcs a föld elektródán PI Platina csúcs a középső és Iridium csúcs a föld elektródán T Kompakt(motoros) láncfűrész, fűnyíró) X Erősített elektróda K Speciális gyújtógyertya (30000 km) W Bougies grande saillie (sauf bougies LS 3X) V Culot avec EM taillée dans la masse F Jupe supérieure à 1 mm A Bougie EM standard + EM auxiliaire(s) latérales R 1 - 2 KΩ																														

TR • ATEŞLEME BUJISI NUMARALAMA SISTEMI

R	F	C	42	L	Z	2	E																											
Rezistans Harf yok Rezistans yok R 3 - 9 KΩ		Elektrod malzemesi Harf yok Standart Nikel Bujiler : Orta elektrod ve yan elektrod (tırnak) nikel C Süper Bujiler : Orta elektrod bakır ortali, yan elektrod nikel N Süper Bujiler Orta elektrod ve yan elektrod bakır ortali		Diş boyu <table border="1"> <thead> <tr> <th>Harf yok</th> <th>Konik</th> <th>Düz</th> </tr> </thead> <tbody> <tr> <td>A</td> <td>11,2</td> <td>12,7</td> </tr> <tr> <td>C</td> <td>7,8</td> <td>9,5</td> </tr> <tr> <td>L</td> <td>17,5</td> <td>19</td> </tr> <tr> <td>H</td> <td>25</td> <td>26,5</td> </tr> </tbody> </table>		Harf yok	Konik	Düz	A	11,2	12,7	C	7,8	9,5	L	17,5	19	H	25	26,5	İzolator ucu uzantısı izolator / kabuk Harf yok 0,5 ile 2,7 mm arası E 2,71 ile 3,8 mm arası G 3,81 mm ve üstü													
Harf yok	Konik	Düz																																
A	11,2	12,7																																
C	7,8	9,5																																
L	17,5	19																																
H	25	26,5																																
Metal dış kabuk <table border="1"> <thead> <tr> <th>Harf yok</th> <th>Ø mm dış</th> <th>Anahtar mm</th> </tr> </thead> <tbody> <tr> <td>D</td> <td>M12 x 1,25</td> <td>18</td> </tr> <tr> <td>Z</td> <td>M12 x 1,25</td> <td>16</td> </tr> <tr> <td>W</td> <td>M12 x 1,25</td> <td>14</td> </tr> <tr> <td>F</td> <td>M14 x 1,25</td> <td>16</td> </tr> <tr> <td>K</td> <td>M18 x 1,50</td> <td>21</td> </tr> <tr> <td>T</td> <td>M10 x 1,00</td> <td>16</td> </tr> <tr> <td>X</td> <td>M12 x 1,25</td> <td>Bi-Hex</td> </tr> </tbody> </table>		Harf yok	Ø mm dış	Anahtar mm	D	M12 x 1,25	18	Z	M12 x 1,25	16	W	M12 x 1,25	14	F	M14 x 1,25	16	K	M18 x 1,50	21	T	M10 x 1,00	16	X	M12 x 1,25	Bi-Hex	Isıl değerler Süper Bujiler 12 Sıcak 22 ↑ 28 30 32 42 52 56 58 62 72 82 92 96 99 ... Soğuk Nikel / Krom Bujiler 200'den Sıcak 1200'e kadar Soğuk		Diş kabuk tipi <table border="1"> <thead> <tr> <th>Harf yok</th> <th>Düz</th> </tr> </thead> <tbody> <tr> <td>J</td> <td>Konik</td> </tr> </tbody> </table>		Harf yok	Düz	J	Konik	
Harf yok	Ø mm dış	Anahtar mm																																
D	M12 x 1,25	18																																
Z	M12 x 1,25	16																																
W	M12 x 1,25	14																																
F	M14 x 1,25	16																																
K	M18 x 1,50	21																																
T	M10 x 1,00	16																																
X	M12 x 1,25	Bi-Hex																																
Harf yok	Düz																																	
J	Konik																																	
		İzolator ucunun tipi Harf yok Uzantısız S Uzantılı Z Uzantılı ve birikinti yapmama özelliği		Diğer özellikler 0,6 mm > tırnak açıklığı S 0,7 mm tırnak açıklığı T 0,8 mm tırnak açıklığı W 0,9 - 1,0 mm tırnak açıklığı 5 1,1 - 1,2 mm tırnak açıklığı 6 1,3 mm tırnak açıklığı 7 1,5 mm tırnak açıklığı Z 2,0 mm tırnak açıklığı																														
		Yan elektrodların sayısı ve konumu Harf yok 1 yan elektrod geleneksel konumda 2 2 yan elektrod, yatay konumda 3 3 yan elektrod, yatay konumda 4 4 yan elektrod, yatay konumda		Diğer özellikler P Platin uçlu bir elektrod (orta veya yan) DP Platin uçlu orta ve yan elektrod I İridium başlıklı elektrod (Elektrod ya da ateşleme iğnesi) DI İridium başlıklı elektrod ve ateşleme iğnesi IP İridium başlıklı elektrod ve Platinium başlıklı ateşleme iğnesi PI Platinium başlıklı elektrod ve İridium başlıklı elektrod. T Küçük (zincir testere, çim biçme) X Takviyeli elektrodlar K Özel seçenekler W Daha fazla izolator ucu uzantısı V Tek parça işlenmiş yan elektrod ve kabuk F Diş ucu ile yan elektrod arası 1 mm den fazla A Standart yan elektrod ve yardımcı yan elektrodlu buji R 1 - 2 KΩ																														

SLO • IDENTIFIKACIJA EYQUEMOVIH VŽIGALNIH SVEČK

R	F	C	42	L	Z	2	E
Upor		Materijal elektrod		Razsežnost navoja		Konica zaščitenege - izolatorja / oklopa	
Bez oznake	Ni upora	Bez oznake	Nikelj vrsta nickel središče in spodnja elektroda	Bez oznake	Stožičast sedež	Bez oznake Od 0,5 do 2,7mm	
R	Od 3 do 9 KΩ	C	Super vrsta nickel središče in spodnja elektroda	A	11,2	E Od 2,7mm do 3,8mm	
		N	Super vrsta bakreno središčno elektroda in tudi spodnja elektroda	C	7,8	G 3,81mm in več	
				L	17,51		
				H	25		
Tip lupine		Toplotna lestvica		Sedež oklepa		Druge posebnosti	
Bez oznake	Ploščat sedež M14 x 1,25 Stožičast sedež M14 x 1,25	Super vrsta	12	Bez oznake	Ploščat sedež	0,6 mm > razdalja	
D	M12 x 1,25		22	J	Stožičast sedež	S Razdalja 0,7 mm	
Z	M12 x 1,25		28			T Razdalja 0,8 mm	
W	M12 x 1,25		30			W Razdalja 0,9 - 1,0 mm	
F	M14 x 1,25		32			5 Razdalja 1,1 - 1,2 mm	
K	M18 x 1,50		42			6 Razdalja 1,3 mm	
T	M10 x 1,00		52			7 Razdalja 1,5 mm	
X	M12 x 1,25		56			Z Razdalja 2,0 mm	
			58			P Elektroda z platinasto konico	
			62			DP Platinast oblečena konica center in spodnja elektroda	
			72			I Elektroda s konico iz iridija (notranja ali zunanja)	
			82			DI Notranje in zunanje elektrode s konico iz iridija	
			92			IP S konico iz iridija na notranji elektrodi in s konico iz platine na zunanji elektrodi	
			96			PI S konico iz platine na notranji elektrodi in s konico iz iridija na zunanji elektrodi	
			99			T Jedrnat	
			...			X Ojaccana elektroda	
			Nikelj / Krom vrsta			K Posebne opcije	
			Od 200			W Veliko uho sveče (razen LS 3X svečke)	
			do 1200			V Oklep s spodnjo elektrodo	
						F Izrastek nad 1 mm	
						A Svečka s standardno spodnjo elektrodo + Dodatna stranska spodnja elektroda	
						R Od 1 do 2 KΩ	

HR • LEGENDA OZNAKA EYQUEM SVJEČICA

R	F	C	42	L	Z	2	E
Otpornik		Materijal elektroda		Navoj		Projekcija vrha	
Bez oznake	bez otpornika	Bez oznake	Ponuda Nikl Centralna i masena elektroda od nikla	Bez oznake	Konusni dosjed	Bez oznake od 0,5 do 2,7mm	
R	otpor između 3 do 9 KΩ	C	Ponuda Super Centralna elektroda s bakrenom jezgrom, niklena masena elektroda	A	11,2	E od 2,7mm do 3,8mm	
		N	Ponuda Super Centralna i masena elektroda s bakrenom jezgrom	C	7,8	G 3,81mm i više	
				L	17,51		
				H	25		
Tip kućišta		Toplinski razred		Dosjed		Ostale karakteristike	
Bez oznaker	Ravni dosjed M14 x 1,25 Konusni dosjed M14 x 1,25		12	Bez oznake	Ravni dosjed	0,6 mm > razmak elektroda	
D	M12 x 1,25		22	J	Konusni dosjed	S Razmak elektroda 0,7 mm	
Z	M12 x 1,25		28			T Razmak elektroda 0,8 mm	
W	M12 x 1,25		30			W Razmak elektroda 0,9 - 1,0 mm	
F	M14 x 1,25		32			5 Razmak elektroda 1,1 - 1,2 mm	
K	M18 x 1,50		42			6 Razmak elektroda 1,3mm	
T	M10 x 1,00		52			7 Razmak elektroda 1,5mm	
X	M12 x 1,25		56			Z Razmak elektroda 2,0 mm	
			58			P Elektroda s vrhom od platine (centralna ili masena)	
			62			DP Elektrode s vrhom od platine (centralna i masena)	
			72			I Elektroda od iridijuma (centralna ili uzemljena)	
			82			DI Iridijum centralna i uzemljena elektroda	
			92			IP Iridijum tip na centralnoj elektrodi i platinska uzemljena elektroda	
			96			PI Platinska centralna elektroda i uzemljena elektroda od iridijuma	
			99			T T Kompaktna (motorne pile, kosilice)	
			...			X Pojačane elektrode	
			Ponuda niki/krom			K Posebne mogućnosti	
			Od 200			W Svječica s velikim priključkom (osim LS3X)	
			do 1200			V Kućište i masena elektroda iz komada	
						F F Rub preko 1 mm	
						A Svječica sa standardnom masenom elektrodom i pomoćnim masenim elektrodama	
						R od 1 do 2 KΩ	

RO • IDENTIFICAREA BUJIILOR CU SCĂNTEIE EYQUEM

R	F	C	42	L	Z	2	E																																																																																		
<table border="1" style="width: 100%; border-collapse: collapse;"> <tr> <th colspan="2">Material elektrod</th> </tr> <tr> <td>Brez oznake</td> <td>Gama nichel Electrod central si de masa din nichel</td> </tr> <tr> <td>C</td> <td>Gama super electrod central cu miez din cupru Electrod de masa din nichel</td> </tr> <tr> <td>N</td> <td>Gama super Electrod central si de masa cu miez din cupru</td> </tr> </table>		Material elektrod		Brez oznake	Gama nichel Electrod central si de masa din nichel	C	Gama super electrod central cu miez din cupru Electrod de masa din nichel	N	Gama super Electrod central si de masa cu miez din cupru	<table border="1" style="width: 100%; border-collapse: collapse;"> <tr> <th colspan="3">Inaltimea filetului</th> </tr> <tr> <td>Nicio litera</td> <td>Conic</td> <td>Plat</td> </tr> <tr> <td>A</td> <td>11,2</td> <td>12,7</td> </tr> <tr> <td>C</td> <td>7,8</td> <td>9,5</td> </tr> <tr> <td>L</td> <td>17,51</td> <td>9</td> </tr> <tr> <td>H</td> <td>25</td> <td>26,5</td> </tr> </table>		Inaltimea filetului			Nicio litera	Conic	Plat	A	11,2	12,7	C	7,8	9,5	L	17,51	9	H	25	26,5	<table border="1" style="width: 100%; border-collapse: collapse;"> <tr> <th colspan="2">Izolator al el central - proiectat izolator/carcasa</th> </tr> <tr> <td>Nicio litera</td> <td>de la 0,5 to 2,7 mm</td> </tr> <tr> <td>E</td> <td>2,71 la 3,8 mm</td> </tr> <tr> <td>G</td> <td>3,81 mm si peste</td> </tr> </table>		Izolator al el central - proiectat izolator/carcasa		Nicio litera	de la 0,5 to 2,7 mm	E	2,71 la 3,8 mm	G	3,81 mm si peste	<table border="1" style="width: 100%; border-collapse: collapse;"> <tr> <th colspan="2">Alte caracteristici</th> </tr> <tr> <td></td> <td>0,6 mm > ditanta intre electrozi</td> </tr> <tr> <td>S</td> <td>0,7 mm ditanta intre electrozi</td> </tr> <tr> <td>T</td> <td>0,8 mm ditanta intre electrozi</td> </tr> <tr> <td>W</td> <td>0,9 - 1,0 mm ditanta intre electrozi</td> </tr> <tr> <td>5</td> <td>1,1 - 1,2 mm ditanta intre electrozi</td> </tr> <tr> <td>6</td> <td>1,3mm ditanta intre electrozi</td> </tr> <tr> <td>7</td> <td>1,5mm ditanta intre electrozi</td> </tr> <tr> <td>Z</td> <td>2,0 mm ditanta intre electrozi</td> </tr> </table>		Alte caracteristici			0,6 mm > ditanta intre electrozi	S	0,7 mm ditanta intre electrozi	T	0,8 mm ditanta intre electrozi	W	0,9 - 1,0 mm ditanta intre electrozi	5	1,1 - 1,2 mm ditanta intre electrozi	6	1,3mm ditanta intre electrozi	7	1,5mm ditanta intre electrozi	Z	2,0 mm ditanta intre electrozi	<table border="1" style="width: 100%; border-collapse: collapse;"> <tr> <td>P</td> <td>1 Electrode cu contact de platina (central sau de masa)</td> </tr> <tr> <td>DP</td> <td>Contact de platina center in spodnja elektroda</td> </tr> <tr> <td>I</td> <td>1 Electrode placat cu Iridiu (cel central sau cel de masa)</td> </tr> <tr> <td>DI</td> <td>Electrozii, central si de masa, placati cu Iridiu</td> </tr> <tr> <td>IP</td> <td>Placare Iridiu pe electrodul central si placare Platina pe electrodul de masa</td> </tr> <tr> <td>PI</td> <td>Placare Platina pe electrodul central si placare Iridiu pe electrodul de masa</td> </tr> <tr> <td>T</td> <td>Compact (drujba, utilaje lente)</td> </tr> <tr> <td>X</td> <td>Electrozi ranforsati</td> </tr> <tr> <td>K</td> <td>Optiuni specifice</td> </tr> <tr> <td>W</td> <td>Bujie cu hexagon mare (exeptie LS 3X)</td> </tr> <tr> <td>V</td> <td>Carcasa cu electrode - monobloc prelucrat</td> </tr> <tr> <td>F</td> <td>Camasa > 1mm</td> </tr> <tr> <td>A</td> <td>Bujie cu electrode de masa standard+ Electrozi de masa auxiliari</td> </tr> <tr> <td>R</td> <td>de la 1 la 2 KΩ</td> </tr> </table>		P	1 Electrode cu contact de platina (central sau de masa)	DP	Contact de platina center in spodnja elektroda	I	1 Electrode placat cu Iridiu (cel central sau cel de masa)	DI	Electrozii, central si de masa, placati cu Iridiu	IP	Placare Iridiu pe electrodul central si placare Platina pe electrodul de masa	PI	Placare Platina pe electrodul central si placare Iridiu pe electrodul de masa	T	Compact (drujba, utilaje lente)	X	Electrozi ranforsati	K	Optiuni specifice	W	Bujie cu hexagon mare (exeptie LS 3X)	V	Carcasa cu electrode - monobloc prelucrat	F	Camasa > 1mm	A	Bujie cu electrode de masa standard+ Electrozi de masa auxiliari	R	de la 1 la 2 KΩ
Material elektrod																																																																																									
Brez oznake	Gama nichel Electrod central si de masa din nichel																																																																																								
C	Gama super electrod central cu miez din cupru Electrod de masa din nichel																																																																																								
N	Gama super Electrod central si de masa cu miez din cupru																																																																																								
Inaltimea filetului																																																																																									
Nicio litera	Conic	Plat																																																																																							
A	11,2	12,7																																																																																							
C	7,8	9,5																																																																																							
L	17,51	9																																																																																							
H	25	26,5																																																																																							
Izolator al el central - proiectat izolator/carcasa																																																																																									
Nicio litera	de la 0,5 to 2,7 mm																																																																																								
E	2,71 la 3,8 mm																																																																																								
G	3,81 mm si peste																																																																																								
Alte caracteristici																																																																																									
	0,6 mm > ditanta intre electrozi																																																																																								
S	0,7 mm ditanta intre electrozi																																																																																								
T	0,8 mm ditanta intre electrozi																																																																																								
W	0,9 - 1,0 mm ditanta intre electrozi																																																																																								
5	1,1 - 1,2 mm ditanta intre electrozi																																																																																								
6	1,3mm ditanta intre electrozi																																																																																								
7	1,5mm ditanta intre electrozi																																																																																								
Z	2,0 mm ditanta intre electrozi																																																																																								
P	1 Electrode cu contact de platina (central sau de masa)																																																																																								
DP	Contact de platina center in spodnja elektroda																																																																																								
I	1 Electrode placat cu Iridiu (cel central sau cel de masa)																																																																																								
DI	Electrozii, central si de masa, placati cu Iridiu																																																																																								
IP	Placare Iridiu pe electrodul central si placare Platina pe electrodul de masa																																																																																								
PI	Placare Platina pe electrodul central si placare Iridiu pe electrodul de masa																																																																																								
T	Compact (drujba, utilaje lente)																																																																																								
X	Electrozi ranforsati																																																																																								
K	Optiuni specifice																																																																																								
W	Bujie cu hexagon mare (exeptie LS 3X)																																																																																								
V	Carcasa cu electrode - monobloc prelucrat																																																																																								
F	Camasa > 1mm																																																																																								
A	Bujie cu electrode de masa standard+ Electrozi de masa auxiliari																																																																																								
R	de la 1 la 2 KΩ																																																																																								
<table border="1" style="width: 100%; border-collapse: collapse;"> <tr> <th colspan="2">Tipul carcasei</th> </tr> <tr> <td>Nicio litera</td> <td>Dimensiunile filetului</td> </tr> <tr> <td>D</td> <td>M12 x 1,25</td> </tr> <tr> <td>Z</td> <td>M12 x 1,25</td> </tr> <tr> <td>W</td> <td>M12 x 1,25</td> </tr> <tr> <td>F</td> <td>M14 x 1,25</td> </tr> <tr> <td>K</td> <td>M18 x 1,50</td> </tr> <tr> <td>T</td> <td>M10 x 1,00</td> </tr> <tr> <td>X</td> <td>M12 x 1,25</td> </tr> </table>		Tipul carcasei		Nicio litera	Dimensiunile filetului	D	M12 x 1,25	Z	M12 x 1,25	W	M12 x 1,25	F	M14 x 1,25	K	M18 x 1,50	T	M10 x 1,00	X	M12 x 1,25	<table border="1" style="width: 100%; border-collapse: collapse;"> <tr> <th colspan="2">Gama de temperatura</th> </tr> <tr> <td>Gama super</td> <td>cald ↑</td> </tr> <tr> <td>12</td> <td></td> </tr> <tr> <td>22</td> <td></td> </tr> <tr> <td>28</td> <td></td> </tr> <tr> <td>30</td> <td></td> </tr> <tr> <td>32</td> <td></td> </tr> <tr> <td>42</td> <td></td> </tr> <tr> <td>52</td> <td></td> </tr> <tr> <td>56</td> <td></td> </tr> <tr> <td>58</td> <td></td> </tr> <tr> <td>62</td> <td></td> </tr> <tr> <td>72</td> <td></td> </tr> <tr> <td>82</td> <td></td> </tr> <tr> <td>92</td> <td></td> </tr> <tr> <td>96</td> <td></td> </tr> <tr> <td>99</td> <td></td> </tr> <tr> <td>...</td> <td>rece ↓</td> </tr> <tr> <td colspan="2">gama Nichel/Crom</td> </tr> <tr> <td>Od 200</td> <td>cald</td> </tr> <tr> <td>do 1200</td> <td>rece</td> </tr> </table>		Gama de temperatura		Gama super	cald ↑	12		22		28		30		32		42		52		56		58		62		72		82		92		96		99		...	rece ↓	gama Nichel/Crom		Od 200	cald	do 1200	rece	<table border="1" style="width: 100%; border-collapse: collapse;"> <tr> <th colspan="2">Scaunul carcasei</th> </tr> <tr> <td>Nicio litera</td> <td>Plat</td> </tr> <tr> <td>J</td> <td>Conic</td> </tr> </table>		Scaunul carcasei		Nicio litera	Plat	J	Conic	<table border="1" style="width: 100%; border-collapse: collapse;"> <tr> <th colspan="2">tipul sau izolatorul electrozului central</th> </tr> <tr> <td>Nicio litera</td> <td>neproiectat</td> </tr> <tr> <td>S</td> <td>proiectat</td> </tr> <tr> <td>Z</td> <td>proiectat & facilitati antiancrasare</td> </tr> </table>		tipul sau izolatorul electrozului central		Nicio litera	neproiectat	S	proiectat	Z	proiectat & facilitati antiancrasare								
Tipul carcasei																																																																																									
Nicio litera	Dimensiunile filetului																																																																																								
D	M12 x 1,25																																																																																								
Z	M12 x 1,25																																																																																								
W	M12 x 1,25																																																																																								
F	M14 x 1,25																																																																																								
K	M18 x 1,50																																																																																								
T	M10 x 1,00																																																																																								
X	M12 x 1,25																																																																																								
Gama de temperatura																																																																																									
Gama super	cald ↑																																																																																								
12																																																																																									
22																																																																																									
28																																																																																									
30																																																																																									
32																																																																																									
42																																																																																									
52																																																																																									
56																																																																																									
58																																																																																									
62																																																																																									
72																																																																																									
82																																																																																									
92																																																																																									
96																																																																																									
99																																																																																									
...	rece ↓																																																																																								
gama Nichel/Crom																																																																																									
Od 200	cald																																																																																								
do 1200	rece																																																																																								
Scaunul carcasei																																																																																									
Nicio litera	Plat																																																																																								
J	Conic																																																																																								
tipul sau izolatorul electrozului central																																																																																									
Nicio litera	neproiectat																																																																																								
S	proiectat																																																																																								
Z	proiectat & facilitati antiancrasare																																																																																								
<table border="1" style="width: 100%; border-collapse: collapse;"> <tr> <th colspan="2">Dimensiunile filetului</th> <th colspan="2">Dim. Hexagon</th> </tr> <tr> <td>Nicio litera</td> <td>Plat M14 x 1,25 Conic M14 x 1,25</td> <td>21</td> <td>21mm 13/16"</td> </tr> <tr> <td></td> <td></td> <td>16</td> <td>16mm 5/8"</td> </tr> </table>		Dimensiunile filetului		Dim. Hexagon		Nicio litera	Plat M14 x 1,25 Conic M14 x 1,25	21	21mm 13/16"			16	16mm 5/8"	<table border="1" style="width: 100%; border-collapse: collapse;"> <tr> <th colspan="2">Pozitia si numarul electrozilor de masa</th> </tr> <tr> <td>Nicio litera</td> <td>1 electrode de masa in pozitie clasica</td> </tr> <tr> <td>2</td> <td>2 electrozi de masa</td> </tr> <tr> <td>3</td> <td>3 electrozi de masa</td> </tr> <tr> <td>4</td> <td>4 electrozi de masa</td> </tr> </table>		Pozitia si numarul electrozilor de masa		Nicio litera	1 electrode de masa in pozitie clasica	2	2 electrozi de masa	3	3 electrozi de masa	4	4 electrozi de masa																																																																
Dimensiunile filetului		Dim. Hexagon																																																																																							
Nicio litera	Plat M14 x 1,25 Conic M14 x 1,25	21	21mm 13/16"																																																																																						
		16	16mm 5/8"																																																																																						
Pozitia si numarul electrozilor de masa																																																																																									
Nicio litera	1 electrode de masa in pozitie clasica																																																																																								
2	2 electrozi de masa																																																																																								
3	3 electrozi de masa																																																																																								
4	4 electrozi de masa																																																																																								

BG • ИДЕНТИФИКАЦИЯ НА СВЕЩИ "EYQUEM"

R	F	C	42	L	Z	2	E																																																																										
<table border="1" style="width: 100%; border-collapse: collapse;"> <tr> <th colspan="2">Resistor</th> </tr> <tr> <td>Bez bukva</td> <td>Bez resistor</td> </tr> <tr> <td>R</td> <td>От 3 до 9 KΩ</td> </tr> </table>		Resistor		Bez bukva	Bez resistor	R	От 3 до 9 KΩ	<table border="1" style="width: 100%; border-collapse: collapse;"> <tr> <th colspan="2">Material na elektroda</th> </tr> <tr> <td>Bez oznake</td> <td>Nichel toplinno chislo Nichelovi centralen i vьnшен электроди</td> </tr> <tr> <td>C</td> <td>Супер топлинно число Централен електроде с медна сърцевина Nichelov vьnшен електроде</td> </tr> <tr> <td>N</td> <td>Супер топлинно число Централен и vьншен электроди с медна сърцевина</td> </tr> </table>		Material na elektroda		Bez oznake	Nichel toplinno chislo Nichelovi centralen i vьnшен электроди	C	Супер топлинно число Централен електроде с медна сърцевина Nichelov vьnшен електроде	N	Супер топлинно число Централен и vьншен электроди с медна сърцевина	<table border="1" style="width: 100%; border-collapse: collapse;"> <tr> <th colspan="3">Дължина на резбата</th> </tr> <tr> <td>Bez bukva</td> <td>Конусна уплътняваща повърхност</td> <td>Плоска уплътняваща повърхност</td> </tr> <tr> <td>A</td> <td>11,2</td> <td>12,7</td> </tr> <tr> <td>C</td> <td>7,8</td> <td>9,5</td> </tr> <tr> <td>L</td> <td>17,51</td> <td>9</td> </tr> <tr> <td>H</td> <td>25</td> <td>26,5</td> </tr> </table>		Дължина на резбата			Bez bukva	Конусна уплътняваща повърхност	Плоска уплътняваща повърхност	A	11,2	12,7	C	7,8	9,5	L	17,51	9	H	25	26,5	<table border="1" style="width: 100%; border-collapse: collapse;"> <tr> <th colspan="2">Износване напред на върха на изолятора/корпус</th> </tr> <tr> <td>Bez oznake</td> <td>От 0,5 до 2,7 mm</td> </tr> <tr> <td>E</td> <td>2,71 до 3,8 mm</td> </tr> <tr> <td>G</td> <td>3,81 mm и повече</td> </tr> </table>		Износване напред на върха на изолятора/корпус		Bez oznake	От 0,5 до 2,7 mm	E	2,71 до 3,8 mm	G	3,81 mm и повече	<table border="1" style="width: 100%; border-collapse: collapse;"> <tr> <th colspan="2">Други характеристики</th> </tr> <tr> <td></td> <td>0,6 mm > разстояние между електродите</td> </tr> <tr> <td>S</td> <td>0,7 mm разстояние между електродите</td> </tr> <tr> <td>T</td> <td>0,8 mm разстояние между електродите</td> </tr> <tr> <td>W</td> <td>0,9 - 1,0 mm разстояние между електродите</td> </tr> <tr> <td>5</td> <td>1,1 - 1,2 mm разстояние между електродите</td> </tr> <tr> <td>6</td> <td>1,3 mm разстояние между електродите</td> </tr> <tr> <td>7</td> <td>1,5 mm разстояние между електродите</td> </tr> <tr> <td>Z</td> <td>2,0 mm разстояние между електродите</td> </tr> </table>		Други характеристики			0,6 mm > разстояние между електродите	S	0,7 mm разстояние между електродите	T	0,8 mm разстояние между електродите	W	0,9 - 1,0 mm разстояние между електродите	5	1,1 - 1,2 mm разстояние между електродите	6	1,3 mm разстояние между електродите	7	1,5 mm разстояние между електродите	Z	2,0 mm разстояние между електродите														
Resistor																																																																																	
Bez bukva	Bez resistor																																																																																
R	От 3 до 9 KΩ																																																																																
Material na elektroda																																																																																	
Bez oznake	Nichel toplinno chislo Nichelovi centralen i vьnшен электроди																																																																																
C	Супер топлинно число Централен електроде с медна сърцевина Nichelov vьnшен електроде																																																																																
N	Супер топлинно число Централен и vьншен электроди с медна сърцевина																																																																																
Дължина на резбата																																																																																	
Bez bukva	Конусна уплътняваща повърхност	Плоска уплътняваща повърхност																																																																															
A	11,2	12,7																																																																															
C	7,8	9,5																																																																															
L	17,51	9																																																																															
H	25	26,5																																																																															
Износване напред на върха на изолятора/корпус																																																																																	
Bez oznake	От 0,5 до 2,7 mm																																																																																
E	2,71 до 3,8 mm																																																																																
G	3,81 mm и повече																																																																																
Други характеристики																																																																																	
	0,6 mm > разстояние между електродите																																																																																
S	0,7 mm разстояние между електродите																																																																																
T	0,8 mm разстояние между електродите																																																																																
W	0,9 - 1,0 mm разстояние между електродите																																																																																
5	1,1 - 1,2 mm разстояние между електродите																																																																																
6	1,3 mm разстояние между електродите																																																																																
7	1,5 mm разстояние между електродите																																																																																
Z	2,0 mm разстояние между електродите																																																																																
<table border="1" style="width: 100%; border-collapse: collapse;"> <tr> <th colspan="2">Вид корпус</th> </tr> <tr> <td>Bez bukva</td> <td>Ключ мм</td> </tr> <tr> <td>D</td> <td>M12 x 1,25</td> </tr> <tr> <td>Z</td> <td>M12 x 1,25</td> </tr> <tr> <td>W</td> <td>M12 x 1,25</td> </tr> <tr> <td>F</td> <td>M14 x 1,25</td> </tr> <tr> <td>K</td> <td>M18 x 1,50</td> </tr> <tr> <td>T</td> <td>M10 x 1,00</td> </tr> <tr> <td>X</td> <td>M12 x 1,25</td> </tr> </table>		Вид корпус		Bez bukva	Ключ мм	D	M12 x 1,25	Z	M12 x 1,25	W	M12 x 1,25	F	M14 x 1,25	K	M18 x 1,50	T	M10 x 1,00	X	M12 x 1,25	<table border="1" style="width: 100%; border-collapse: collapse;"> <tr> <th colspan="2">Топлинно число</th> </tr> <tr> <td>Супер топлинно число</td> <td>Горещ ↑</td> </tr> <tr> <td>12</td> <td></td> </tr> <tr> <td>22</td> <td></td> </tr> <tr> <td>28</td> <td></td> </tr> <tr> <td>30</td> <td></td> </tr> <tr> <td>32</td> <td></td> </tr> <tr> <td>42</td> <td></td> </tr> <tr> <td>52</td> <td></td> </tr> <tr> <td>56</td> <td></td> </tr> <tr> <td>58</td> <td></td> </tr> <tr> <td>62</td> <td></td> </tr> <tr> <td>72</td> <td></td> </tr> <tr> <td>82</td> <td></td> </tr> <tr> <td>92</td> <td></td> </tr> <tr> <td>96</td> <td></td> </tr> <tr> <td>99</td> <td></td> </tr> <tr> <td>...</td> <td>Студен ↓</td> </tr> <tr> <td colspan="2">Nichel/Xром топлинно число</td> </tr> <tr> <td>От 200</td> <td>Горещ</td> </tr> <tr> <td>До 1200</td> <td>Студен</td> </tr> </table>		Топлинно число		Супер топлинно число	Горещ ↑	12		22		28		30		32		42		52		56		58		62		72		82		92		96		99		...	Студен ↓	Nichel/Xром топлинно число		От 200	Горещ	До 1200	Студен	<table border="1" style="width: 100%; border-collapse: collapse;"> <tr> <th colspan="2">Уплътняваща повърхност на корпуса</th> </tr> <tr> <td>Bez bukva</td> <td>Плоска уплътняваща повърхност</td> </tr> <tr> <td>J</td> <td>Конусна уплътняваща повърхност</td> </tr> </table>		Уплътняваща повърхност на корпуса		Bez bukva	Плоска уплътняваща повърхност	J	Конусна уплътняваща повърхност	<table border="1" style="width: 100%; border-collapse: collapse;"> <tr> <th colspan="2">Вид връх на изолятора</th> </tr> <tr> <td>Bez bukva</td> <td>Не е изнесен напред</td> </tr> <tr> <td>S</td> <td>Изнесен напред</td> </tr> <tr> <td>Z</td> <td>Изнесен напред плюс свойство против замърсяване</td> </tr> </table>		Вид връх на изолятора		Bez bukva	Не е изнесен напред	S	Изнесен напред	Z	Изнесен напред плюс свойство против замърсяване
Вид корпус																																																																																	
Bez bukva	Ключ мм																																																																																
D	M12 x 1,25																																																																																
Z	M12 x 1,25																																																																																
W	M12 x 1,25																																																																																
F	M14 x 1,25																																																																																
K	M18 x 1,50																																																																																
T	M10 x 1,00																																																																																
X	M12 x 1,25																																																																																
Топлинно число																																																																																	
Супер топлинно число	Горещ ↑																																																																																
12																																																																																	
22																																																																																	
28																																																																																	
30																																																																																	
32																																																																																	
42																																																																																	
52																																																																																	
56																																																																																	
58																																																																																	
62																																																																																	
72																																																																																	
82																																																																																	
92																																																																																	
96																																																																																	
99																																																																																	
...	Студен ↓																																																																																
Nichel/Xром топлинно число																																																																																	
От 200	Горещ																																																																																
До 1200	Студен																																																																																
Уплътняваща повърхност на корпуса																																																																																	
Bez bukva	Плоска уплътняваща повърхност																																																																																
J	Конусна уплътняваща повърхност																																																																																
Вид връх на изолятора																																																																																	
Bez bukva	Не е изнесен напред																																																																																
S	Изнесен напред																																																																																
Z	Изнесен напред плюс свойство против замърсяване																																																																																
<table border="1" style="width: 100%; border-collapse: collapse;"> <tr> <th colspan="2">Позиция и брой на vьншен електроде(и)</th> </tr> <tr> <td>Bez bukva</td> <td>1 vьншен електроде конвенционална позиция</td> </tr> <tr> <td>2</td> <td>2 странични vьншни електроди</td> </tr> <tr> <td>3</td> <td>3 странични vьншни електроди</td> </tr> <tr> <td>4</td> <td>4 странични vьншни електроди</td> </tr> </table>		Позиция и брой на vьншен електроде(и)		Bez bukva	1 vьншен електроде конвенционална позиция	2	2 странични vьншни електроди	3	3 странични vьншни електроди	4	4 странични vьншни електроди	<table border="1" style="width: 100%; border-collapse: collapse;"> <tr> <td>P</td> <td>1 Electrode с платинен връх (централен или vьншен)</td> </tr> <tr> <td>DP</td> <td>Централен и vьншен электроди с платинен връх</td> </tr> <tr> <td>I</td> <td>Иридиев електроде (централен или за масата)</td> </tr> <tr> <td>DI</td> <td>Иридиев край на централния електроде и електрода за масата</td> </tr> <tr> <td>IP</td> <td>Иридиев край на централния електроде и платинен електроде за масата</td> </tr> <tr> <td>PI</td> <td>Платинен край на централния електроде и иридиев електроде за масата</td> </tr> <tr> <td>T</td> <td>Компактен (моторни триони, косачки)</td> </tr> <tr> <td>X</td> <td>Подсилени електроди</td> </tr> <tr> <td>K</td> <td>Специфични опции</td> </tr> <tr> <td>W</td> <td>Голяма клемна запалителна свещ (освен LS 3X свещи)</td> </tr> <tr> <td>V</td> <td>Корпус с vьншен електроде изработен като моноблок</td> </tr> <tr> <td>F</td> <td>Пола над 1 mm</td> </tr> <tr> <td>A</td> <td>Свещ със стандартен vьншен електроде + помощен страничен vьншен електроде(и)</td> </tr> <tr> <td>R</td> <td>От 1 до 2 KΩ</td> </tr> </table>		P	1 Electrode с платинен връх (централен или vьншен)	DP	Централен и vьншен электроди с платинен връх	I	Иридиев електроде (централен или за масата)	DI	Иридиев край на централния електроде и електрода за масата	IP	Иридиев край на централния електроде и платинен електроде за масата	PI	Платинен край на централния електроде и иридиев електроде за масата	T	Компактен (моторни триони, косачки)	X	Подсилени електроди	K	Специфични опции	W	Голяма клемна запалителна свещ (освен LS 3X свещи)	V	Корпус с vьншен електроде изработен като моноблок	F	Пола над 1 mm	A	Свещ със стандартен vьншен електроде + помощен страничен vьншен електроде(и)	R	От 1 до 2 KΩ																																								
Позиция и брой на vьншен електроде(и)																																																																																	
Bez bukva	1 vьншен електроде конвенционална позиция																																																																																
2	2 странични vьншни електроди																																																																																
3	3 странични vьншни електроди																																																																																
4	4 странични vьншни електроди																																																																																
P	1 Electrode с платинен връх (централен или vьншен)																																																																																
DP	Централен и vьншен электроди с платинен връх																																																																																
I	Иридиев електроде (централен или за масата)																																																																																
DI	Иридиев край на централния електроде и електрода за масата																																																																																
IP	Иридиев край на централния електроде и платинен електроде за масата																																																																																
PI	Платинен край на централния електроде и иридиев електроде за масата																																																																																
T	Компактен (моторни триони, косачки)																																																																																
X	Подсилени електроди																																																																																
K	Специфични опции																																																																																
W	Голяма клемна запалителна свещ (освен LS 3X свещи)																																																																																
V	Корпус с vьншен електроде изработен като моноблок																																																																																
F	Пола над 1 mm																																																																																
A	Свещ със стандартен vьншен електроде + помощен страничен vьншен електроде(и)																																																																																
R	От 1 до 2 KΩ																																																																																

TECHNICAL CHARACTERISTICS CARACTÉRISTIQUES TECHNIQUES

TECHNISCHE INFORMATIONEN
CARACTERÍSTICAS TÉCNICAS



21

EYQUEM

EYQUEM	Short ref	Internal code	EAN code	Packaging																														
--------	-----------	---------------	----------	-----------	--	--	--	--	--	--	--	--	--	--	--	--	--	--	--	--	--	--	--	--	--	--	--	--	--	--	--	--	--	--

Eyquem Original Equipment range

200	A60	0 911 007 069	3 760 107 900 661	Box 10	M14x1 25	12.7	21	•																										25 Nm	Screwed	0.6	
502	A174	0 911 007 350	3 760 107 901 590	P. film 10	M14x1 25	12.7	21	•																										25 Nm	Screwed	0.6	
500C	A46	0 911 007 063	3 760 107 900 715	Box 10	M14x1 25	9.5	21	•																										25 Nm	Screwed	0.6	
600 LS	A169	0 911 007 336	3 760 107 901 545	P. film 10	M14x1 25	19	21	•																										25 Nm	Screwed	0.75	
600 S	A170	0 911 007 344	3 760 107 901 552	P. film 10	M14x1 25	12.7	21	•																										25 Nm	Screwed	0.6	
705 S	A171	0 911 007 003	3 760 107 901 606	P. film 10	M14x1 25	12.7	21	•																										25 Nm	Screwed	0.6	
705 S MOBY	A172	0 911 007 342	3 760 107 901 569	P. film 10	M14x1 25	12.7	21	•																										25 Nm	Screwed	0.6	
707 LS	A163	0 911 007 339	3 760 107 901 576	P. film 10	M14x1 25	19	21	•																										25 Nm	Screwed	0.75	
750 LS	A166	0 911 007 011	3 760 107 901 538	P. film 10	M14x1 25	19	21	•																										25 Nm	Screwed	0.65	
755 LJS	A173	0 911 007 001	3 760 107 901 514	P. film 10	M14x1 25	17.5	16		•																								15 Nm	Screwed	0.65		
755 LS	A167	0 911 007 340	3 760 107 901 583	P. film 10	M14x1 25	19	21	•																										25 Nm	Screwed	0.6	
805 LJS	A96	0 911 007 075	3 760 107 900 340	Box 10	M14x1 25	17.5	16		•																									15 Nm	Screwed	0.65	
805 LP	A79	0 911 007 073	3 760 107 900 333	Box 10	M14x1 25	19	21	•																										15 Nm	Screwed	0.6	
850	A51	0 911 007 059	3 760 107 900 685	Box 10	M14x1 25	12.7	21	•																										25 Nm	Screwed	0.55	
883 LJP	A87	0 911 007 015	3 760 107 900 678	Box 10	M14x1 25	17.5	16		•																									15 Nm	Screwed	0.6	
1000	A168	0 911 007 351	3 760 107 902 795	Box 10	M14x1 25	12.7	21	•																										25 Nm	Screwed	0.55	
C 30 LS	A47	0 911 007 089	3 760 107 900 180	Box 10	M14x1 25	19	21	•																										25 Nm	Screwed	0.75	
C 32	A33	0 911 007 301	3 760 107 900 258	Box 10	M14x1 25	12.7	21	•																										25 Nm	Screwed	0.6	
C 32 LS	A31	0 911 007 095	3 760 107 900 197	Box 10	M14x1 25	19	21	•																										25 Nm	Screwed	0.75	
C 32 S	A8	0 911 007 087	3 760 107 900 203	Box 10	M14x1 25	12.7	21	•																										25 Nm	Screwed	0.75	
C 32 S	B3	0 910 004 004	3 760 107 902 849	Blister 4	M14x1 25	12.7	21	•																										25 Nm	Screwed	0.75	
C 42 LJS 3	A77	0 911 007 079	3 760 107 900 784	Box 10	M14x1 25	17.5	16		•																									15 Nm	Solid	1.2	
C 42 S	A12	0 911 007 153	3 760 107 900 272	Box 10	M14x1 25	12.7	21	•																										25 Nm	Screwed	0.75	
C 42 S	B7	0 910 004 020	3 760 107 902 870	Blister 4	M14x1 25	12.7	21	•																										25 Nm	Screwed	0.75	
C 52 LJS	A23	0 911 007 149	3 760 107 900 289	Box 10	M14x1 25	17.5	16		•																									15 Nm	Screwed	0.65	
C 52 LS	A1	0 911 007 081	3 760 107 900 159	Box 10	M14x1 25	19	21	•																										25 Nm	Screwed	0.8	
C 52 LS	B1	0 910 004 001	3 760 107 902 825	Blister 4	M14x1 25	19	21	•																										25 Nm	Screwed	0.8	
C 52 LS 3X	A28	0 911 007 265	3 760 107 900 296	Box 10	M14x1 25	19	21	•																										25 Nm	Screwed	0.9	
C 52 LS 3X	B25	0 910 004 035	3 760 107 902 979	Blister 4	M14x1 25	19	21	•																										25 Nm	Screwed	0.9	
C 62	A20	0 911 007 155	3 760 107 900 326	Box 10	M14x1 25	12.7	21	•																										25 Nm	Screwed	0.65	
C 62 LJS	A19	0 911 007 143	3 760 107 900 265	Box 10	M14x1 25	17.5	16		•																									15 Nm	Screwed	0.65	
C 62 LJS	B2	0 910 004 017	3 760 107 902 832	Blister 4	M14x1 25	17.5	16		•																									15 Nm	Screwed	0.65	
C 62 LS	A4	0 911 007 147	3 760 107 900 210	Box 10	M14x1 25	19	21	•																										25 Nm	Screwed	0.65	
C 62 LS	A53	0 911 007 163	3 760 107 901 378	Box 10	M14x1 25	19	21	•																										25 Nm	Solid	0.65	
C 62 LS	B5	0 910 004 018	3 760 107 902 856	Blister 4	M14x1 25	19	21	•																										25 Nm	Screwed	0.65	
C 62 LS 3X	A13	0 911 007 255	3 760 107 900 302	Box 10	M14x1 25	19	21	•																											25 Nm	Screwed	0.8
C 62 LS 3X	B15	0 910 004 049	3 760 107 902 894	Blister 4	M14x1 25	19	21	•																										25 Nm	Screwed	0.8	
C 62 S	A55	0 911 007 141	3 760 107 900 814	Box 10	M14x1 25	12.7	21	•																										25 Nm	Screwed	0.75	
C 72	A64	0 911 007 211	3 760 107 900 869	Box 10	M14x1 25	12.7	21	•																										25 Nm	Screwed	0.65	
C 72 LJS	A22	0 911 007 145	3 760 107 900 739	Box 10	M14x1 25	17.5	16		•																									15 Nm	Screwed	0.65	
C 72 LS 3X	A63	0 911 007 259	3 760 107 900 357	Box 10	M14x1 25	19	21	•																										25 Nm	Screwed	0.8	
C 82 (1)	A90	0 911 007 215	3 760 107 900 845	Box 10	M14x1 25	12.7	21	•																										25 Nm	Screwed	0.65	
C 82 L (1)	A105	0 911 007 223	3 760 107 900 852	Box 10	M14x1 25	19	21	•																										25 Nm	Screwed	0.65	
C 82 LJS	A52	0 911 007 133	3 760 107 900 364	Box 10	M14x1 25	17.5	16		•																									15 Nm	Screwed	0.9	
C 82 LS	A40	0 911 007 135	3 760 107 900 371	Box 10	M14x1 25	19	21	•																										25 Nm	Screwed	0.8	
C 82 LS	B6	0 910 004 016	3 760 107 902 863	Blister 4	M14x1 25	19	21	•																										25 Nm	Screwed	0.8	
C 82 LS 3X	A92	0 911 007 257	3 760 107 900 821	Box 10	M14x1 25	19	21	•																										25 Nm	Screwed	0.8	
C 92 LS	A89	0 911 007 251	3 760 107 900 838	Box 10	M14x1 25	19	21	•																										25 Nm	Screwed	0.7	
F755LZ	A175	0 911 007 003	3 760 107 901 521	P. film 10	M14x1 25	19	16	•																									25 Nm	Solid	0.9		
FC 42 LS	A15	0 911 007 093	3 760 107 900 388	Box 10	M14x1 25	19	16	•																										25 Nm	Solid	0.8	
FC 42 LS	B14	0 910 004 006	3 760 107 902 887	Blister 4	M14x1 25	19	16	•																										25 Nm	Solid	0.8	
FC 52LS	A2	0 911 007 091	3 760 107 900 166	Box 10	M14x1 25	19	16	•																										25 Nm	Solid	0.8	
FC 52 LS	B9																																				

By short reference / Par référence courte

Nach Kurzbezeichnung / Por código corto

Short ref	EYQUEM	Internal code
A1	C 52 LS	0 911 007 081
B1	C 52 LS	0 910 004 001
A2	FC 52 LS	0 911 007 091
B2	C 62 LJS	0 910 004 017
A3	RFC 52 LS	0 911 007 191
B3	C 32 S	0 910 004 004
A4	C 62 LS	0 911 007 147
A5	RFC 42 LZ 2E	0 911 007 285
B5	C 62 LS	0 910 004 018
A6	RC 62 LS	0 911 007 169
B6	C 82 LS	0 910 004 016
A7	RFN 58 LZ	0 911 007 315
B7	C 42 S	0 910 004 020
A8	C 32 S	0 911 007 087
A9	RC 52 LS	0 911 007 085
B9	FC 52 LS	0 910 004 005
A10	RFC 58 LZ 2E	0 911 007 309
A11	RFC 58 LZK	0 911 007 239
A12	C 42 S	0 911 007 153
A13	C 62 LS 3X	0 911 007 255
B13	RC 62 LS 5	0 911 004 054
A14	FC 58 LS	0 911 007 151
B14	FC 42 LS	0 910 004 006
A15	FC 42 LS	0 911 007 093
B15	C 62 LS 3X	0 910 004 049
A16	RFC 58 LS 3	0 911 007 111
B16	RFC 52 LS	0 910 004 041
A17	R 500 CT	0 911 007 047
B17	RC 62 LS	0 910 004 021
A18	RFC 58 LS	0 911 007 197
A19	C 62 LJS	0 911 007 143
B19	RC 32 LS	0 910 004 007
A20	C 62	0 911 007 155
B20	RC 52 LS	0 910 004 003
A22	C 72 LJS	0 911 007 145
A23	C 52 LJS	0 911 007 149
B23	RC 42 S	0 910 004 023
A24	RC 62 LS 5	0 911 007 165
B24	RFC 52 LS 5	0 910 004 025
A25	RFC 42 LS	0 911 007 187
B25	C 52 LS 3X	0 910 004 035
A26	RFC 52 LS 5	0 911 007 193
B26	RC 72 LS	0 910 004 022
A27	RFN 52 LZ	0 911 007 267
B27	RC 52 LJS	0 910 004 024
A28	C 52 LS 3X	0 911 007 265
B28	RFN 58 LZ	0 910 004 051
A29	RKC 62 JS	0 911 007 043
B29	RFC 58 LZK	0 910 004 048
A30	C 72 LS	0 911 007 157
B30	RFC 42 LZ 2E	0 910 004 050
A31	C 32 LS	0 911 007 095
B31	RFC 58 LZ 2E	0 910 004 039
A32	RC 72 LS	0 911 007 071
A33	C 32	0 911 007 301
B33	RFC 58 LS 3	0 910 004 008
A34	RC 58 LZ 3EX	0 911 007 303
A35	RC 52 LZ 3EX	0 911 007 305
A36	RC 52 LS 5	0 911 007 083
A37	R 700 CTS	0 911 007 051
A38	RFC 58 LS 5	0 911 007 199
B38	RC 52 LS 5	0 910 004 002

Short ref	EYQUEM	Internal code
A40	C 82 LS	0 911 007 135
A41	FN 52 LS	0 911 007 319
A42	RFC 62 LS 5	0 911 007 185
A43	FC 62 LS	0 911 007 161
A44	R 755 CT	0 911 007 045
A45	R 202 CT	0 911 007 057
A46	500 C	0 911 007 063
A47	C 30 LS	0 911 007 089
A48	RFC 62 LS	0 911 007 201
B48	RFC 58 LS 5	0 910 004 026
A49	RC 32 LS	0 911 007 101
A50	RFC 58 LZ	0 911 007 291
B50	RFN 52 HZ	0 910 004 042
A51	850	0 911 007 059
A52	C 82 LJS	0 911 007 133
A53	C 62 LS	0 911 007 163
B53	RC 62 HJSP	0 910 004 043
A54	RFC 58 LZ 2	0 911 007 311
B54	RC 58 LZ 3EX	0 910 004 044
A55	C 62 S	0 911 007 141
B55	RFC 58 LZ 3EX	0 910 004 045
A56	RFC 62 LS 3	0 911 007 113
B56	RC 52 LJS 5	0 910 004 046
A57	FC 62 LS 3X	0 911 007 261
B57	RC 62 HJS 6	0 910 004 047
A58	RFC 58 LZ 3EX	0 911 007 299
B58	RWC 52 HSK	0 910 004 168
A59	RFC 62 LS 3X	0 911 007 263
B59	RZC 58 LS	0 910 004 169
A60	200	0 911 007 069
A61	R 500 CJT	0 911 007 049
A62	RC 52 LJS	0 911 007 181
A63	C 72 LS 3X	0 911 007 259
A64	C 72	0 911 007 211
A65	RFC 82 LS 5	0 911 007 205
A66	RFC 52 LS 3	0 911 007 115
A67	RC 52 LZE	0 911 007 281
A68	RC 62 LJS	0 911 007 179
A69	RC 42 S	0 911 007 173
A70	R 502 CT	0 911 007 055
A71	RFN 62 LZ	0 911 007 241
A73	R 755 CJT	0 911 007 053
A74	RC 52 LJS 5	0 911 007 183
A75	RFC 58 LZE 5	0 911 007 295
A76	RFC 82 LS	0 911 007 195
A77	C 42 LJS 3	0 911 007 079
A78	RC 82 LS	0 911 007 137
A79	805 LP	0 911 007 073
A80	RC 72 LJS 3	0 911 007 117
A82	FC 62 LS 3	0 911 007 105
A83	RFC 42 LS 5	0 911 007 203
A84	FC 82 LS 3	0 911 007 107
A85	FC 96 LS 3	0 911 007 243
A86	RFC 62 LZ 3EX	0 911 007 321
A87	883 LJP	0 911 007 015
A88	RC 72 LJS	0 911 007 177
A89	C 92 LS	0 911 007 251
A90	C 82	0 911 007 215
A92	C 82 LS 3X	0 911 007 257
A93	RC 72	0 911 007 213
A94	RC 82 L	0 911 007 225
A95	RC 62 S	0 911 007 175

Short ref	EYQUEM	Internal code
A96	805 LJSP	0 911 007 075
A98	RC 82 LS 5	0 911 007 139
A99	RFC 58 LZDP	0 911 007 317
A100	RFN 52 HZ 3A	0 911 007 355
A101	RFC 58 LZ 5	0 911 007 293
A102	RFC 52 LZE	0 911 007 279
A103	RC 62 LJS 5	0 911 007 207
A104	RC 72 LJS 5	0 911 007 090
A105	C 82 L	0 911 007 223
A106	C 72 L	0 911 007 219
A109	RC 30 LS	0 911 007 099
A110	RC 32 LS 5	0 911 007 097
A112	RFN 42 LZG 5	0 911 007 077
A114	RC 72 L	0 911 007 325
A115	RC 82	0 911 007 217
A116	RC 72 LS 5	0 911 007 167
A117	RFC 32 LZ 5	0 911 007 134
A120	RFC 58 LZ 3EX	0 911 007 307
A129	RC 22 LJZ 7	0 911 007 132
A131	RC 22 LZ	0 911 007 128
A136	C 42	0 911 007 253
A137	RC 42 JS	0 911 007 014
A138	RC 42 JS 5	0 911 007 016
A139	RC 48 JS	0 911 007 012
A140	RTC 68	0 911 007 018
A141	RTC 72	0 911 007 020
A142	RTC 72 L	0 911 007 022
A149	RFC 52 LZDP 5	0 911 007 379
A150	RFC 62 LZ 2	0 911 007 388
A152	RFC 52 LZDP	0 911 007 386
A153	RFN 52 LZDPF 5	0 911 007 349
A154	RFC 42 LZ 4E	0 911 007 378
A155	RC 52 LJS 4E	0 911 007 381
A156	RFC 52 LZDP 6	0 911 007 377
A157	RFN 52 HZ	0 911 007 359
A158	RFN 58 HZ	0 911 007 357
A159	RFC 52 LZ 4E	0 911 007 380
A163	707 LS	0 911 007 339
A166	750 LS	0 911 007 011
A167	755 LS	0 911 007 340
A168	1000	0 911 007 351
A169	600 LS	0 911 007 336
A170	600 S	0 911 007 344
A171	705 S	0 911 007 003
A172	705 S MOBY	0 911 007 342
A173	755 LJS	0 911 007 001
A174	502	0 911 007 350
A175	F 755 LZ	0 911 007 003
A178	RFC 58 LZP	0 911 007 376
A179	RC 42 HJS3E 5	0 911 007 383
A180	RN 22 HJSE 6	0 911 007 382
A181	RC 62 HJSP	0 911 007 374
A182	RC 62 HJS 6	0 911 007 375
A183	FN 58 LZKFR	0 911 007 390
A184	RFN 42 HZDP 5	0 911 007 398
A185	RFN 62 LZDP 5	0 911 007 393
A186	RFC 58 LZP 5	0 911 007 401
A187	RFN 58 LZDP 5	0 911 007 395
A188	RFC 42 LZDP	0 911 007 396
A189	RXC 62 HSEDP	0 911 007 405
A190	RZC 58 LS	0 911 007 406
A191	RFC 58 HZEDP 5	0 911 007 400

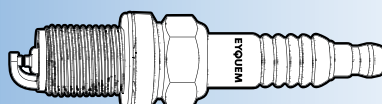

By short reference / Par référence courte

Nach Kurzbezeichnung / Por código corto

Short ref	EYQUEM	Internal code
A192	FN 62 LZFDPR 2A	0 911 007 399
A193	RFC 58 LZP 4	0 911 007 402
A194	RFN 42 LZP	0 911 007 397
A195	FN 42 LZDPR 5	0 911 007 394
A196	RFC 96 HS 3	0 911 007 391
A197	RWC 52 HSK	0 911 007 404
A198	FN 58 LZDPR	0 911 007 403
A199	RTC 62 LSDP	0 911 007 408
A500	RXC 58 HSEDP	0 911 007 410
A503	RN 62 LJZDP 6	0 911 007 425
A504	RFN 62 HZDP	0 911 007 426
A505	RN 62 LJZEDP 6	0 911 007 427
A506	RXC 42 HZGP 5	0 911 007 428
A507	RFC 62 LSDP 5	0 911 007 429
A508	RZC 72 LS	0 911 007 430
A509	RZC 62 LS 5	0 911 007 431
A510	RZC 62 LSE	0 911 007 432
A511	RFC 62 LS4GF 6	0 911 007 433
A512	RFN 42 HZP 5	0 911 007 434
A513	RXC 42 HSEDP 2A	0 911 007 435
A514	RXN 62 HSEP	0 911 007 436
A515	RFN 58 LZ 3A	0 911 007 437
A516	RFN 58 HZ 3A	0 911 007 438
A518	RZC 62 LSDP 5K	0 911 007 441
A519	RFN 58 LZDP	0 911 007 440
A520	RWC 62 HSDPS	0 911 007 446
A521	FN 58 LZKFR 5	0 911 007 442
A522	FC 62 LSDPR	0 911 007 443
A523	FN 68 LZDPR	0 911 007 444
A524	RZC 62 LS	0 911 007 445
A525	RXN 62 HSDP	0 911 007 447
A526	RZC 62 HSET	0 911 007 451
A527	ZN 68 HSTDPR	0 911 007 448
A528	RWC 58 HSE5DP	0 911 007 449
A530	RWC 58 HSEW	0 911 007 454
A531	RZN 32 HSWDP	0 911 007 469
A532	RFN 42 LZG	0 911 007 453
A533	RZC 58 HST	0 911 007 452
A534	RFN 58 HZ 5	0 911 007 466
A535	RZC 82 LSDPT	0 911 007 467
A536	RZC 82 HSDPS	0 911 007 468
A537	FN 72 HZIPRSO	0 911 007 470
A538	ZN 62 LSDPFRSO	0 911 007 471
A539	RFN 58 LZDPE5	0 911 007 472
A540	RXN 72 HSDPFT	0 911 007 473
A541	RXN 72 HSIPFS	0 911 007 477
A542	RWN 42 HSIPS	0 911 007 476
A543	FC 52 LZWR	0 911 007 475
A544	RWN 42 HSIPW	0 911 007 478
A545	RFN 52 HZ 5	0 911 007 474
A548	FN 68 LZIPFRS	0 911 007 479
A550	RXN 72 HSIPFSO	0 911 007 480
A551	FN 72 LZIPFRS	0 911 007 482
A552	RZC 68 HS2	0 911 007 481
A555	RWC 42 HSEW	0 911 007 483

Short ref	EYQUEM	Internal code
-----------	--------	---------------

Short ref	EYQUEM	Internal code
-----------	--------	---------------

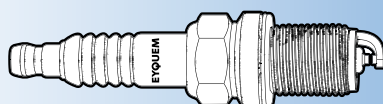

By internal code / Par référence interne

Nach interner Kurzbezeichnung / Por código interno

Internal code	EYQUEM	Short ref
0 910 004 001	C 52 LS	B1
0 910 004 002	RC 52 LS 5	B38
0 910 004 003	RC 52 LS	B20
0 910 004 004	C 32 S	B3
0 910 004 005	FC 52 LS	B9
0 910 004 006	FC 42 LS	B14
0 910 004 007	RC 32 LS	B19
0 910 004 008	RFC 58 LS 3	B33
0 910 004 016	C 82 LS	B6
0 910 004 017	C 62 LJS	B2
0 910 004 018	C 62 LS	B5
0 910 004 020	C 42 S	B7
0 910 004 021	RC 62 LS	B17
0 910 004 022	RC 72 LS	B26
0 910 004 023	RC 42 S	B23
0 910 004 024	RC 52 LJS	B27
0 910 004 025	RFC 52 LS 5	B24
0 910 004 026	RFC 58 LS 5	B48
0 910 004 035	C 52 LS 3X	B25
0 910 004 039	RFC 58 LZ 2E	B31
0 910 004 041	RFC 52 LS	B16
0 910 004 042	RFN 52 HZ	B50
0 910 004 043	RC 62 HJSP	B53
0 910 004 044	RC 58 LZ 3EX	B54
0 910 004 045	RFC 58 LZ 3EX	B55
0 910 004 046	RC 52 LJS 5	B56
0 910 004 047	RC 62 HJS6	B57
0 910 004 048	RFC 58 LZK	B29
0 910 004 049	C 62 LS 3X	B15
0 910 004 050	RFC 42 LZ 2E	B30
0 910 004 051	RFN 58 LZ	B28
0 910 004 054	RC 62 LS 5	B13
0 910 004 168	RWC 52 HSK	B58
0 910 004 169	RZC 58 LS	B59
0 911 007 001	755 LJS	A173
0 911 007 003	F755LZ	A175
0 911 007 003	705 S	A171
0 911 007 011	750 LS	A166
0 911 007 012	RC 48 JS	A139
0 911 007 014	RC 42 JS	A137
0 911 007 015	883 LJP	A87
0 911 007 016	RC 42 JS5	A138
0 911 007 018	RTC 68	A140
0 911 007 020	RTC72	A141
0 911 007 022	RTC 72 L	A142
0 911 007 043	RKC 62 JS	A29
0 911 007 045	R 755 CT	A44
0 911 007 047	R 500 CT	A17
0 911 007 049	R 500 CJT	A61
0 911 007 051	R 700 CTS	A37
0 911 007 053	R 755 CJT	A73
0 911 007 055	R 502 CT	A70
0 911 007 057	R 202 CT	A45
0 911 007 059	850	A51
0 911 007 063	500C	A46
0 911 007 069	200	A60
0 911 007 071	RC 72 LS	A32
0 911 007 073	805 LP	A79
0 911 007 075	805 LJS	A96
0 911 007 077	RFN 42 LZG 5	A112
0 911 007 079	C 42 LJS 3	A77
0 911 007 081	C 52 LS	A1

Internal code	EYQUEM	Short ref
0 911 007 083	RC 52 LS 5	A36
0 911 007 085	RC 52 LS	A9
0 911 007 087	C 32 S	A8
0 911 007 089	C 30 LS	A47
0 911 007 090	RC 72 LJS 5	A104
0 911 007 091	FC 52 LS	A2
0 911 007 093	FC 42 LS	A15
0 911 007 095	C 32 LS	A31
0 911 007 097	RC 32 LS 5	A110
0 911 007 099	RC 30 LS	A109
0 911 007 101	RC 32 LS	A49
0 911 007 105	FC 62 LS 3	A82
0 911 007 107	FC 82 LS 3	A84
0 911 007 111	RFC 58 LS 3	A16
0 911 007 113	RFC 62 LS 3	A56
0 911 007 115	RFC 52 LS 3	A66
0 911 007 117	RC 72 LJS 3	A80
0 911 007 128	RC 22 LZ	A131
0 911 007 132	RC 22 LJZ 7	A129
0 911 007 133	C 82 LJS	A52
0 911 007 134	RFC 32 LZ 5	A117
0 911 007 135	C 82 LS	A40
0 911 007 137	RC 82 LS	A78
0 911 007 139	RC 82 LS 5	A98
0 911 007 141	C 62 S	A55
0 911 007 143	C 62 LJS	A19
0 911 007 145	C 72 LJS	A22
0 911 007 147	C 62 LS	A4
0 911 007 149	C 52 LJS	A23
0 911 007 151	FC 58 LS	A14
0 911 007 153	C 42 S	A12
0 911 007 155	C 62	A20
0 911 007 161	FC62LS	A43
0 911 007 163	C 62 LS	A53
0 911 007 165	RC 62 LS 5	A24
0 911 007 167	RC 72 LS 5	A116
0 911 007 169	RC 62 LS	A6
0 911 007 173	RC 42 S	A69
0 911 007 175	RC 62 S	A95
0 911 007 177	RC 72 LJS	A88
0 911 007 179	RC 62 LJS	A68
0 911 007 181	RC 52 LJS	A62
0 911 007 183	RC 52 LJS 5	A74
0 911 007 185	RFC 62 LS 5	A42
0 911 007 187	RFC 42 LS	A25
0 911 007 191	RFC 52 LS	A3
0 911 007 193	RFC 52 LS 5	A26
0 911 007 195	RFC 82 LS	A76
0 911 007 197	RFC 58 LS	A18
0 911 007 199	RFC 58 LS 5	A38
0 911 007 201	RFC 62 LS	A48
0 911 007 203	RFC 42 LS 5	A83
0 911 007 205	RFC 82 LS 5	A65
0 911 007 207	RC 62 LJS 5	A103
0 911 007 211	C72	A64
0 911 007 213	RC 72	A93
0 911 007 215	C 82	A90
0 911 007 217	RC 82	A115
0 911 007 219	C 72 L	A106
0 911 007 223	C 82 L	A105
0 911 007 225	RC 82 L	A94
0 911 007 239	RFC 58 LZK	A11

Internal code	EYQUEM	Short ref
0 911 007 241	RFN 62 LZ	A71
0 911 007 243	FC 96 LS 3	A85
0 911 007 251	C 92 LS	A89
0 911 007 253	C 42	A136
0 911 007 255	C 62 LS 3X	A13
0 911 007 257	C 82 LS 3X	A92
0 911 007 259	C 72 LS 3X	A63
0 911 007 261	FC 62 LS 3X	A57
0 911 007 263	RFC 62 LS 3X	A59
0 911 007 265	C 52 LS 3X	A28
0 911 007 267	RFN 52 LZ	A27
0 911 007 279	RFC 52 LZE	A102
0 911 007 281	RC 52 LZE	A67
0 911 007 285	RFC 42 LZ 2E	A5
0 911 007 291	RFC 58 LZ	A50
0 911 007 293	RFC 58 LZ 5	A101
0 911 007 295	RFC 58 LZE 5	A75
0 911 007 299	RFC 58 LZ 3EX	A58
0 911 007 301	C 32	A33
0 911 007 303	RC 58 LZ 3EX	A34
0 911 007 305	RC 52 LZ 3EX	A35
0 911 007 307	RFC 58 LZ 3EX	A120
0 911 007 309	RFC 58 LZ 2E	A10
0 911 007 311	RFC 58 LZ 2	A54
0 911 007 315	RFN 58 LZ	A7
0 911 007 317	RFC 58 LZDP	A99
0 911 007 319	FN 52 LS	A41
0 911 007 321	RFC 62 LZ 3EX	A86
0 911 007 325	RC 72 L	A114
0 911 007 336	600 LS	A169
0 911 007 339	707 LS	A163
0 911 007 340	755 LS	A167
0 911 007 342	705 S MOBY	A172
0 911 007 344	600 S	A170
0 911 007 349	RFN 52 LZDPF 5	A153
0 911 007 350	502	A174
0 911 007 351	1000	A168
0 911 007 355	RFN 52 HZ 3A	A100
0 911 007 357	RFN 58 HZ	A158
0 911 007 359	RFN 52 HZ	A157
0 911 007 374	RC 62 HJSP	A181
0 911 007 375	RC 62 HJS6	A182
0 911 007 376	RFC 58 LZP	A178
0 911 007 377	RFC 52 LZDP 6	A156
0 911 007 378	RFC 42 LZ 4E	A154
0 911 007 379	RFC 52 LZDP 5	A149
0 911 007 380	RFC 52 LZ 4E	A159
0 911 007 381	RC 52 LJS 4E	A155
0 911 007 382	RN 22 HJSE6	A180
0 911 007 383	RC 42 HJS3E5	A179
0 911 007 386	RFC 52 LZDP	A152
0 911 007 388	RFC 62 LZ 2	A150
0 911 007 390	FN 58 LZKFR	A183
0 911 007 391	RFC 96 HS 3	A196
0 911 007 393	RFN 62 LZDP 5	A185
0 911 007 394	FN 42 LZDPR5	A195
0 911 007 395	RFN 58 LZDP 5	A187
0 911 007 396	RFC 42 LZDP	A188
0 911 007 397	RFN 42 LZP	A194
0 911 007 398	RFN 42 HZDP 5	A184
0 911 007 399	FN 62 LZDPR 2A	A192
0 911 007 400	RFC 58 HZEDP 5	A191

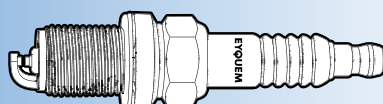

By internal code / Par référence interne

Nach interner Kurzbezeichnung / Por código interno

Internal code	EYQUEM	Short ref
0 911 007 401	RFC 58 LZ F 5	A186
0 911 007 402	RFC 58 LZ P 4	A193
0 911 007 403	FN 58 LZ DPR	A198
0 911 007 404	RWC52HSK	A197
0 911 007 405	RXC 62 HSEDP	A189
0 911 007 406	RZC 58 LS	A190
0 911 007 408	RTC 62 LSDP	A199
0 911 007 410	RXC 58 HSEDP	A500
0 911 007 425	RN 62 LJZDP 6	A503
0 911 007 426	RFN 62 HZDP	A504
0 911 007 427	RN 62 LJZEDP 6	A505
0 911 007 428	RXC 42 HZGP 5	A506
0 911 007 429	RFC 62 LSDP 5	A507
0 911 007 430	RZC 72 LS	A508
0 911 007 431	RZC 62 LS 5	A509
0 911 007 432	RZC 62 LSE	A510
0 911 007 433	RFC 62 LS4GF 6	A511
0 911 007 434	RFN 42 HZP 5	A512
0 911 007 435	RXC 42 HSEDP 2A	A513
0 911 007 436	RXN 62 HSEP	A514
0 911 007 437	RFN 58 LZ 3A	A515
0 911 007 438	RFN 58 HZ 3A	A516
0 911 007 441	RZC 62 LSDP 5K	A518
0 911 007 440	RFN 58 LZDP	A519
0 911 007 446	RWC 62 HSDPS	A520
0 911 007 442	FN 58 LZKFR 5	A521
0 911 007 443	FC 62 LSDPR	A522
0 911 007 444	FN 68 LZDPR	A523
0 911 007 445	RZC 62 LS	A524
0 911 007 447	RXN 62 HSDP	A525
0 911 007 451	RZC 62 HSET	A526
0 911 007 448	ZN 68 HSTDPR	A527
0 911 007 449	RWC 58 HSE5DP	A528
0 911 007 454	RWC 58 HSEW	A530
0 911 007 469	RZN 32 HSWDP	A531
0 911 007 453	RFN 42 LZG	A532
0 911 007 452	RZC 58 HST	A533
0 911 007 466	RFN 58 HZ 5	A534
0 911 007 467	RZC 82 LSDPT	A535
0 911 007 468	RZC 82 HSDPS	A536
0 911 007 470	FN 72 HZIPRSO	A537
0 911 007 471	ZN 62 LSDPFRSO	A538
0 911 007 472	RFN 58 LZDPE5	A539
0 911 007 473	RXN 72 HSDPFT	A540
0 911 007 474	RFN 52 HZ5	A545
0 911 007 475	FC 52 LZWR	A543
0 911 007 476	RWN 42 HSIPS	A542
0 911 007 477	RXN 72 HSIPFS	A541
0 911 007 478	RWN 42 HSIPW	A544
0 911 007 479	FN 68 LZIPFRS	A548
0 911 007 480	RXN 72 HSIPFSO	A550
0 911 007 481	RZC 68 HS2	A552
0 911 007 482	FN 72 LZIPFRS	A551
0 911 007 483	RWC 42 HSEW	A555

Internal code	EYQUEM	Short ref
---------------	--------	-----------

Internal code	EYQUEM	Short ref
---------------	--------	-----------

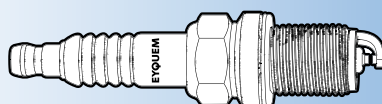

Recommendations / Conseils de montage

Anwendungsratschläge / Consejos de utilización

GB

RECOMMENDATIONS

Fitting of spark plugs:

Check that the seal is in good condition.

A torque spanner at a setting of 20 to 30 N.m. should be used.

For taper seated spark plugs, use a torque setting of 10 to 20 N.m.

F

CONSEILS D'EMPLOI

Montage des bougies:

On Vérifier le bon état du joint.

Il est recommandé pour ce montage d'utiliser une clé dynamométrique réglée de 20 à 30 N.m.

Pour les bougies à siège conique, couple de 10 à 20 N.m.

D

ANWENDUNGSRATSCHLÄGE

Zündkerzen-Montage:

Man prüft die Dichtung auf einen guten Zustand.

Es ist notwendig, für die Montage einen regulierbaren Drehmoment-Schlüssel von 20-30 N.m. zu verwenden.

Für Kerzen mit konischem Sitz ist das Anzugsmoment 10-20 N.m.

ES

CONSEJOS DE UTILIZACIÓN

Montaje de las bujías:

Se controlará el buen estado de la junta exterior.

Se recomienda utilizar para el montaje una llave dinamométrica reglada de 20 a 30 N.m.

Para las bujías de asiento cónico utilizar un par de apriete de 10 a 20 N.m.

ITA

CONSIGLI PER L'USO

Montaggio della candele:

Verificare il buono stato della guarnizione.

Per questo montaggio, è raccomandato l'impiego di una chiave dinamometrica regolata tra 20 e 30 N.m.

Per le candele a sede conica, la coppia di serraggio è tra 10 e 20 N.m.

NL

MONTAGE VOORSCHRIFTEN

Montage van de bougies:

Controleer de pakking.

Het wordt aanbevolen om voor de montage een sleutel te gebruiken van 20 tot 30 N.m.

Voor bougies met conische zitting dient een koppel te worden gebruikt van 10 tot 20 N.m.

SLO

Priporočila

Pritrjevanje vžigalne svečke

Preveriti da je tesnilo v dobrem stanju

Vijačni ključ mora biti uporabljen pri 20 do 30 N.m.

Za stožičasto sedečo svečko uporabi vijačni ključ 10 do 20 N.m.

RO

RECOMANDARI

Montarea bujiei;

Verificati etanseitatea.

Forța de strângere recomandată este de 20 la 30 Nm

În cazul bujiilor conice se recomandă o strângere de 10 la 20 Nm.

P

RECOMENDAÇÕES DE UTILIZAÇÃO

Montagem das velas:

Verificar o bom estado da junta.

Recomenda-se para esta montagem a utilização chave dinamométrica regulada de 20 a 30 N.m.

Para as velas de sede cônica, binário de aperto de 10 a 20 N.m.

PL

ZALECENIA MONTAOWE

Montaż świec:

Należy sprawdzić czy uszczelka jest w dobrym stanie.

Zaleca się dokręcenie kluczem dynamometrycznym momentem 20 ÷ 30 Nm.

Dla świec o gnieździe stożkowym - moment dokręcenia powinien wynosić od 10 do 20 Nm.

GR

ΣΥΜΒΟΥΛΕΣ ΤΟΠΟΘΕΤΗΣΗΣ

Τοι οίθηση των ΜΙ ουζί:

Ελέγξατε την καλή κατάσταση της ροδέλας των μί ουζί.

Για το σφίξιμο των μί ουζί χρησιμοι οίηστε ένα δυναμόκλειδο με ρύθμιση 20 εως 30 Nm. Για μί ουζί με κωνική έδρα η ρύθμιση Ι ρέι ει να είναι 10 εως 20 Nm.

CZ

DOPORUČENÍ K MONTÁŽI

Montáž zapalovacích svíček:

Zkontrolujte, zda je těsnění v dobrém stavu.

Je nutné použít k montáži regulovatelný momentový klíč od 20 do 30Nm.

U svíček s kónickým usazením je utahovací moment 10 – 20Nm.

H

TANÁCSOK

Gyújtógyertya beillesztése:

Ellenőrizze, hogy a tömítógyűrű jó állapotban van-e. A gyertyakulcs

meghúzásánál 20-30 Nm forgatónyomatékot kell használni. Kónuszos menetű gyertya esetén használjon 10-20 Nm forgatónyomatékot.

TR

TAVSIYELER

Atefleme bujişi montajı:

Buji contasinın (pul) iyi durumda olup olmadıđını kontrol edin.

20 ila 30 Nm'ye ayarlı bir tork anahtarı kullanılmalıdır.

Konik oturmali (pulsuz) bujiler için tork anahtarı 10 ila 20 Nm'ye ayarlanmalıdır.

HR

Preporuke:

Montaža svjećica:

Proverite da su brtva i dosjedi čisti i neoštećeni.

Za pritezanje treba koristiti moment ključ s postavkom od 20 do 30 Nm

Za konusne dosjede pritezni moment iznosi 10 da 20 Nm

BG

ПРЕПОРЪКИ

Поставяне на свещи:

Проверка на доброто състояние на уплътнението.

Динамометричен ключ от 20 до 30 Nm трябва да бъде използван.

При свещи с конусна уплътняваща повърхност използвайте

динамометричен ключ от 10 до 20 Nm.

APPLICATIONS BY VEHICLE APPLICATIONS PAR VÉHICULE

VERWENDUNG NACH FAHRZEUGTYP
APLICACIONES POR VEHÍCULO



33

EYQUEM



Box 10
Blister 4



F3 → 1

AC

COBRA	428 : 7.0 V8			01.1967	12.1973	RKC 62 JS	A29		0,9	
ME	3.0 V6				08.1986	RC 62 LS	A6	B17	0,8	L65

ACURA

INTEGRA	1.6 i 16V	D16 A1 Cat				RFC 58 LS5	A38	B48	1,1	F54-5
	1.8 i 16V	B18 A [DOHC]	96/131			RFC 58 LS5	A38	B48	1,1	F54-5
	1.8 i 16V	B18 C1/C5 VTEC [DOHC]				RFC 42 LS5	A83		1,1	F54-5
LEGEND	2.5 i V6 24V	C25 A1	110/150			RFC 58 LS5	A38	B48	1,1	F54-5
	2.7 i V6 24V	C27 A1 Cat	124/169			RFC 58 LS5	A38	B48	1,1	F54-5
	3.2 i V6 24V	C32 A1 [SOHC]	155/211			RFC 42 LS5	A83		1,1	F54-5
LEGEND III	3.5	C35A2	151/205	08.1996		RFN 58 LZDP5	A187		1,1	
NSX	3.0 i V6 24V	C30 A	200/272			RFC 52 LZDP5	A149		1,1	

ALFA ROMEO

6	2.0	019.32	100/136	01.1979	12.1986	C 62 LS	A4	B5	0,8	L65
	2.5	019.13	116-118/158-160	01.1979	06.1984	C 52 LS	A1	B1	0,8	L65
	2.5 ie	019.28	110-117/150-159	09.1983	12.1986	C 62 LS	A4	B5	0,8	L65
33	1.2	307.43	57/78	01.1990	08.1991	C 52 LS3X	A28	B25	0,9	L65
	1.2	305.00	46/63	06.1983	03.1988	C 82 LS	A40	B6	0,8	L87
	1.3 ie Hit, Feeling, Tender, Flag, 4x4		65/88	02.1994		C 72 LS (1)	A30		0,8	L87
	1.35 AS	307.32	66/90	01.1990	10.1994	C 62 LS3X	A13	B15	0,8	L65
	1.35 DC	305.02	55-58/75-79	06.1983	02.1990	C 72 LS (1)	A30		0,8	L87
	1.35 DC, S, S Red	305.86 - 305.87	58-63/79-86	06.1983	12.1989	C 82 LS	A40	B6	0,8	L87
	1.35 ie L, Imola, Sport Wagon	307.53	65/88	09.1991	10.1994	C 82 LS	A40	B6	0,8	L87
	1.35 S, S Sport Wagon...	301.68	63-64/86-87	06.1983	12.1989	C 82 LS	A40	B6	0,8	L87
	1.35 S, S Veloce, Sprint	301.68	63-64/86-87	06.1983	12.1989	C 82 LS	A40	B6	0,8	L87
	1.35 Sport Wagon	305.86 - 305.87	58-63/79-86	06.1983	12.1989	C 82 LS	A40	B6	0,8	L87
	1.35 V, VL, Sport Wagon, 4x4	307.32	66/90	01.1990	10.1994	C 62 LS3X	A13	B15	0,8	L65
	1.4	304.55	64/87	09.1991	03.1994	C 82 LS	A40	B6	0,8	L87
	1.4 ie Sport Wagon, 4x4	307.55	64/87	09.1991	03.1994	C 82 LS	A40	B6	0,8	L87
	1.4 Sport Wagon	305.06	63/86	03.1988	03.1994	C 82 LS	A40	B6	0,8	L87
	1.5 4x4	305.04	62/84	06.1983	10.1984	C 82 LS	A40	B6	0,8	L87
	1.5 4x4	305.08	77/105	10.1986	03.1990	C 82 LS	A40	B6	0,8	L87
	1.5 AS	307.34	77/105	02.1990	03.1994	C 72 LS3X	A63		0,8	L87
	1.5 Giardinetta 4x4	305.04	62/84	06.1983	10.1984	C 82 LS	A40	B6	0,8	L87
	1.5 ie	307.50	74/101	06.1990	10.1994	C 72 LS3X	A63		0,8	L87
	1.5 ie 4x4, Sport Wagon	307.51	70-72/95-98	06.1990	10.1994	C 82 LS	A40	B6	0,8	L87
	1.5 Quadrifoglio Verde	301.82	77/105	06.1984	12.1986	C 82 LS	A40	B6	0,8	L87
	1.5 Sport Wagon, 4x4	305.08	77/105	10.1986	03.1990	C 82 LS	A40	B6	0,8	L87
	1.5 Ti	305.04	62/84	06.1983	10.1984	C 82 LS	A40	B6	0,8	L87
	1.5 Ti	305.88	77/105	07.1987	10.1989	C 72 LS3X	A63		0,8	L87
	1.5 Ti 4x4	305.20	66/90	06.1984	10.1986	C 82 LS	A40	B6	0,8	L87
	1.5 Ti Giardinetta 4x2, 4x4	301.46	77/105	06.1984	03.1988	C 82 LS	A40	B6	0,8	L87
	1.5 Ti Giardinetta 4x4, Quadrifoglio Oro	305.20	66/90	06.1984	10.1986	C 82 LS	A40	B6	0,8	L87
	1.5 Ti Sport Wagon 4x4, Ti Veloce	301.46	77/105	06.1984	03.1988	C 82 LS	A40	B6	0,8	L87
	1.7 ie	307.36	79/107	01.1990	03.1994	C 72 LS3X	A63		0,8	L87
	1.7 ie	307.40	77/105	04.1992	10.1994	C 72 LS (1)	A30		0,8	L87
	1.7 ie	307.37	77/105	10.1987	10.1994	C 82 LS	A40	B6	0,8	L87
	1.7 ie 16V Boxer Quadrifoglio Verde	M691AA.17.A	101/137	03.1990	09.1994	RFC 82 LS	A76		0,8	F86
	1.7 ie 16V Elegante, Permanent, Quadrifoglio Verde, Quadrifoglio 4, 4x4	307.46 - 307.47	95-98/129-133	01.1990	10.1994	FC 62 LS3X	A57		0,9	F86
	1.7 ie 4x4	307.36	79/107	01.1990	03.1994	C 72 LS3X	A63		0,8	L87
	1.7 ie 4x4	305.58 Cat	67-79/91-107	10.1987	03.1992	C 82 LS	A40	B6	0,8	L87
	1.7 ie 4x4	307.37	77/105	10.1987	10.1994	C 82 LS	A40	B6	0,8	L87
	1.7 ie Quadrifoglio 4	307.37	77/105	10.1987	10.1994	C 82 LS	A40	B6	0,8	L87
	1.7 ie Quadrifoglio Verde, Sport Wagon	305.58 - 305.78	67-79/91-107	10.1987	03.1992	C 82 LS	A40	B6	0,8	L87
	1.7 ie Sport Wagon	307.36	79/107	01.1990	03.1994	C 72 LS3X	A63		0,8	L87
	1.7 ie Sport Wagon	305.58 Cat	67-79/91-107	10.1987	03.1992	C 82 LS	A40	B6	0,8	L87
	1.7 ie Sport Wagon	307.37	77/105	10.1987	10.1994	C 82 LS	A40	B6	0,8	L87
	1.7 ie Sport Wagon 4x4	307.36	79/107	01.1990	03.1994	C 72 LS3X	A63		0,8	L87
	1.7 ie Sport Wagon 4x4	305.58 Cat	67-79/91-107	10.1987	03.1992	C 82 LS	A40	B6	0,8	L87
	1.7 ie Sport Wagon 4x4	307.37	77/105	10.1987	10.1994	C 82 LS	A40	B6	0,8	L87
	1.7 Quadrifoglio Verde	305.50	81-84-86/110-114-117	09.1986	10.1994	C 72 LS3X	A63		0,8	L87
	1.7 Sport Wagon, QV	305.50	81-84-86/110-114-117	09.1986	10.1994	C 72 LS3X	A63		0,8	L87
	1.7 Sprint	305.50	81-84-86/110-114-117	09.1986	10.1994	C 72 LS3X	A63		0,8	L87

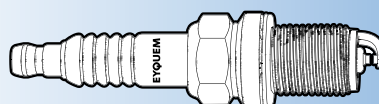

(1) Available until end of stock

- (a) 30 000 km
- (b) 60 000 km
- (c) Grey sticker on ignition coil
- (d) Green sticker on ignition coil

- (e) Hex 21 mm
- (f) Hex 16 mm
- (g) Recommended for cold weather



kW/HP

Box
10Blister
4

F3→1

ALFA ROMEO

75	1.6	061.00	81/110	05.1985	09.1989	C 82 LS	A40	B6	0,7	L87
	1.6 ie	611.01	77-79/105-107	08.1989	02.1992	C 82 LS	A40	B6	0,7	L87
	1.6 ie	611.02	77-79/105-107	08.1989	02.1992	RC 72 LS	A32	B26	0,8	L87
	1.8 ie America, E	061.34 - 062.02	118/160	02.1986	08.1991	C 82 LS	A40	B6	0,7	L87
	1.8 ie HEL	062.02	85-89/115-121	05.1985	09.1989	C 82 LS	A40	B6	0,7	L87
	1.8 ie Indy	062.02 - 612.01	85-89/115-121	05.1985	09.1989	C 82 LS	A40	B6	0,7	L87
	1.8 ie Scuderia	062.02	85-89/115-121	05.1985	09.1989	C 82 LS	A40	B6	0,7	L87
	1.8 ie Scuderia	061.68	88/120	09.1988	02.1992	C 82 LS	A40	B6	0,7	L87
	1.8 ie Turbo America	061.58	181/246	02.1986	08.1991	C 82 LS	A40	B6	0,7	L87
	1.8 ie Turbo E	061.58	181/246	02.1986	08.1991	C 82 LS	A40	B6	0,7	L87
	1.8 ie Turbo Potenziata, S Speciale	612.03	121/165	12.1988	02.1992	C 82 LS	A40	B6	0,7	L87
	2.0	062.12	94/128	05.1985	10.1988	C 82 LS	A40	B6	0,7	L87
	2.0 ie Twin Spark	hon061.66 - 062.24	106/144	01.1986	12.1992	RFC 82 LS	A76		0,8	F86
	2.5 ie V6	019.11 - 016.46	110-113/150-154	09.1985	02.1992	RC 62 LS	A6	B17	0,8	L65
	3.0 V6 America, Milano	061.24 - 061.20	133/181	01.1986	02.1992	C 62 LS	A4	B5	0,8	L65
	3.0 V6 ES Coupé Zagato	615.01	152/207	03.1989	02.1992	C 82 LS	A40	B6	0,7	L87
	3.0 V6 Potenziata	615.03	139-141/189-192	02.1990	02.1992	C 82 LS	A40	B6	0,7	L87
90	1.8 ie	062.02	89/121	10.1984	01.1987	C 82 LS	A40	B6	0,8	L87
	2.0	062.12	94/128	10.1984	06.1986	C 82 LS	A40	B6	0,8	L87
	2.0 ie	017.13	94/128	10.1984	01.1987	C 62 LS	A4	B5	0,7	L65
	2.0 ie V6	062.10	97/132	10.1984	01.1987	C 62 LS	A4	B5	0,7	L65
	2.5 ie V6	019.11 - 016.46	110-115/150-156	10.1984	12.1990	C 62 LS	A4	B5	0,7	L65
145	1.4 i.e. 16V.T.S.	AR 33503/AR 38501	76/103	12.1996	01.2001	RFC 58 LZP4	A193		1,6	
	1.4 i.e. 16V.T.S.	AR 33503/AR 38501	76/103	12.1996	01.2001	RTC 62 LSDP	A199		0,6	
	1.4 ie	33.501 [OHC]	66/90	04.1994	11.1996	C 82 LS	A40	B6	0,8	L87
	1.6 i.e. 16V.T.S.	AR 67601/AR 38201	88/120	12.1996	01.2001	RFC 58 LZP4	A193		1,6	
	1.6 i.e. 16V.T.S.	AR 67601/AR 38201	88/120	12.1996	01.2001	RTC 62 LSDP	A199		0,6	
	1.6 ie	33.201 [OHC]	76-78/103-106	04.1994	09.1996	C 82 LS	A40	B6	0,8	L87
	1.7 ie 16V	33.401 [DOHC]	96/131	04.1994	11.1996	RFC 82 LS	A76		0,8	F86
	1.8 i.e. 16V.T.S.	AR 38401/AR 67106	103/140	12.1996	12.1998	RFC 58 LZP4	A193		1,6	
	1.8 i.e. 16V.T.S.	AR 38401/AR 67106	103/140	12.1996	12.1998	RTC 62 LSDP	A199		0,6	
	2.0 16V.T.S.	AR 67204	110/150	10.1995	01.2001	RFC 58 LZP4	A193		1,6	
	2.0 16V.T.S.	AR 67204	110/150	10.1995	01.2001	RTC 62 LSDP	A199		0,6	
146	1.4 i.e.	AR 33501	66/90	12.1994	12.1996	C 72 LS3X	A63		0,8	L87
	1.6 i.e. 16V.T.S.	AR 67601/AR 38201	88/120	11.1996	01.2001	RFC 58 LZP4	A193		1,6	
	1.6 i.e. 16V.T.S.	AR 67601/AR 38201	88/120	11.1996	01.2001	RTC 62 LSDP	A199		0,6	
	1.6 ie	33.201 [OHC]	76-78/103-106	12.1994	09.1996	C 82 LS	A40	B6	0,8	L87
	1.7 i.e. 16V	AR 33401	95/129	12.1994	12.1996	RFC 82 LS	A76		0,8	F86
	1.8 i.e. 16V.T.S.	AR 32201	106/144	03.1998	01.2001	RFC 58 LZP4	A193		1,6	
	1.8 i.e. 16V.T.S.	AR 32201	106/144	03.1998	01.2001	RTC 62 LSDP	A199		0,6	
	1.8 i.e. 16V.T.S.	AR 38401/AR 67106	103/140	11.1996	01.2001	RFC 58 LZP4	A193		1,6	
	1.8 i.e. 16V.T.S.	AR 38401/AR 67106	103/140	11.1996	01.2001	RTC 62 LSDP	A199		0,6	
	2.0 16V.T.S.	AR 67204	110/150	10.1995	01.2001	RFC 58 LZP4	A193		1,6	
	2.0 16V.T.S.	AR 67204	110/150	10.1995	01.2001	RTC 62 LSDP	A199		0,6	
147	1.6 16V T.SPARK (937AXB1A)	AR 32104	88/120	01.2001		RFC 58 LZP4	A193		1,6	
	1.6 16V T.SPARK (937AXB1A)	AR 32104	88/120	01.2001		RTC 62 LSDP	A199		0,6	
	2.0 16V T.SPARK (937AXC1_)	AR 32310	110/150	01.2001		RFC 58 LZP4	A193		1,6	
	2.0 16V T.SPARK (937AXC1_)	AR 32310	110/150	01.2001		RTC 62 LSDP	A199		0,6	
155	1.6 16V.T.S.	AR 67601	88/120	05.1996	12.1997	RFC 58 LZP4	A193		1,6	
	1.6 16V.T.S.	AR 67601	88/120	05.1996	12.1997	RTC 62 LSDP	A199		0,6	
	1.7 ie T.Sp	67.105	83-85/113-116	02.1992	04.1996	RFC 82 LS	A76		0,8	F86
	1.7 ie T.Sp	67.103 [OHC] Cat	93/126	02.1992	04.1993	RFC 82 LS	A76		0,8	F86
	1.7 T.S. 16V	AR 67106	103/140	05.1996	12.1997	RFC 58 LZP4	A193		1,6	
	1.7 T.S. 16V	AR 67106	103/140	05.1996	12.1997	RTC 62 LSDP	A199		0,6	
	1.8 ie T.Sp, Silverstone/L	67.101 - 67.102 Cat	93-95/126-129	02.1992	12.1996	RFC 82 LS	A76		0,8	F86
	2.0 ie T.Sp	67.201 - 67.202	104/141	02.1992	02.1995	RFC 82 LS	A76		0,8	F86
	2.0 ie Turbo 4x4	67.203	137-140/186-190	02.1992	12.1997	C 72 LS3X	A63		0,8	L87
	2.0 T.S. 16V (167.A2G)	AR 67204	110/150	03.1995	12.1997	RFC 58 LZP4	A193		1,6	
	2.0 T.S. 16V (167.A2G)	AR 67204	110/150	03.1995	12.1997	RTC 62 LSDP	A199		0,6	
	2.0 Ti 16V Quadrifoglio 4	67.203 [OHC] Cat	137-140/186-190	02.1992	12.1997	C 72 LS3X	A63		0,8	L87
	2.5 ie V6	67.301 - 67.302 - 67.303 Cat	121/165	02.1992	12.1997	RC 72 LS	A32	B26	0,8	L87
	3.0 ie V6	64.304 Cat	155/211	02.1992		RC 72 LS	A32	B26	0,8	L87
156	1.6 16V T.SPARK (932A4)	AR 32102/AR 32103/ AR 32104/AR 67601	88/120	09.1997	09.2005	RFC 58 LZP4	A193		1,6	

(f) Available until end of stock

(a) 30 000 km

(b) 60 000 km

(c) Grey sticker on ignition coil

(d) Green sticker on ignition coil

(e) Hex 21 mm

(f) Hex 16 mm

(g) Recommended for

cold weather



EYQUEM



Box
10

Blister
4



F3-1

ALFA ROMEO

	1.6 16V T.SPARK (932A4)	AR 32102/AR 32103/ AR 32104/AR 67601	88/120	09.1997	09.2005	RTC 62 LSDP	A199		0,6	
	1.8 16V T.SPARK (932A3)	AR 32201	106/144	09.1997	10.2000	RFC 58 LZP4	A193		1,6	
	1.8 16V T.SPARK (932A3)	AR 32201	106/144	09.1997	10.2000	RTC 62 LSDP	A199		0,6	
	1.8 16V T.SPARK (932A31)	AR 32205	103/140	10.2000	09.2005	RFC 58 LZP4	A193		1,6	
	1.8 16V T.SPARK (932A31)	AR 32205	103/140	10.2000	09.2005	RTC 62 LSDP	A199		0,6	
	2.0 16V T.SPARK (932A2)	AR 32301	114/155	09.1997	10.2000	RFC 58 LZP4	A193		1,6	
	2.0 16V T.SPARK (932A2)	AR 32301	114/155	09.1997	10.2000	RTC 62 LSDP	A199		0,6	
	2.0 16V T.SPARK (932A21)	AR 32310	110/150	10.2000	03.2002	RFC 58 LZP4	A193		1,6	
	2.0 16V T.SPARK (932A21)	AR 32310	110/150	10.2000	03.2002	RTC 62 LSDP	A199		0,6	
	2.5 V6 24V (932A1)	AR 32401	140/190	09.1997	10.2000	FN 58 LZDPR	A198		0,75	
156 Sportwagon	1.6 16V T.SPARK. (932A4)	AR 32102/AR 32103/ AR 32104/AR 67601	88/120	05.2000	05.2006	RFC 58 LZP4	A193		1,6	
	1.6 16V T.SPARK. (932A4)	AR 32102/AR 32103/ AR 32104/AR 67601	88/120	05.2000	05.2006	RTC 62 LSDP	A199		0,6	
	1.8 16V T.SPARK (932A3)	AR 32201	106/144	05.2000	10.2000	RFC 58 LZP4	A193		1,6	
	1.8 16V T.SPARK (932A3)	AR 32201	106/144	05.2000	10.2000	RTC 62 LSDP	A199		0,6	
	1.8 16V T.SPARK (932B31)	AR 32205	103/140	10.2000	05.2006	RFC 58 LZP4	A193		1,6	
	1.8 16V T.SPARK (932B31)	AR 32205	103/140	10.2000	05.2006	RTC 62 LSDP	A199		0,6	
	2.0 16V T.SPARK (932A2)	AR 32301	114/155	05.2000	10.2000	RFC 58 LZP4	A193		1,6	
	2.0 16V T.SPARK (932A2)	AR 32301	114/155	05.2000	10.2000	RTC 62 LSDP	A199		0,6	
	2.0 16V T.SPARK (932B21)	AR 32310	110/150	10.2000	03.2002	RFC 58 LZP4	A193		1,6	
	2.0 16V T.SPARK (932B21)	AR 32310	110/150	10.2000	03.2002	RTC 62 LSDP	A199		0,6	
159 (939)	NEW 1.8 MPI	939 A4.000	103/140	03.2007	11.2011	RFN 42 LZG	A532		0,9	
159 (939)	NEW 1.8 MPI	939 A4.000	103/140	03.2007	11.2011	RFN 42 LZG	A532		0,9	
Spotwagon										
159	2.2 JTS	939 A5.000	136/185	09.2005	11.2011	FN 42 LZDPR5	A195		0,9	
164	2.0 ie T.Sp	064.20 - 64.103 - 064.16	109/148	06.1987	09.1992	RFC 82 LS	A76		0,8	F86
	2.0 ie Turbo	064.76	126-129/171-175	10.1987	09.1992	RC 72 LS	A32	B26	0,8	L87
	2.0 ie V6 Turbo	64.102 Cat	148-154/201-209	10.1990	09.1998	C 82 LS	A40	B6	0,8	L87
	2.5 ie V6	66.201	120/165	09.1992	09.1998	RC 72 LS	A32	B26	0,8	L87
	3.0 ie V6	64.305 - 66.303 - 064.10 - 064.12	132/180	06.1987	09.1992	RC 72 LS	A32	B26	0,8	L87
	3.0 ie V6 24V	66.301 - 66.302	152-155/207-211	09.1992	10.1998	RFC 82 LS	A76		0,8	F86
	3.0 ie V6 24V Quadrifoglio Verde	64.304 Cat	168-171/228-233	01.1993	10.1998	RFC 82 LS	A76		0,8	F86
166	2.0 ie V6 Turbo	34.102 [DOHC]	151/205	10.1998		RC 72 LS	A32	B26	0,7	L87
	2.0 T.SPARK (936A3A)	AR 34103	114/155	09.1998	10.2000	RFC 58 LZP4	A193		1,6	
	2.0 T.SPARK (936A3A)	AR 34103	114/155	09.1998	10.2000	RTC 62 LSDP	A199		0,6	
	2.0 T.SPARK (936A3B)	AR 36301	110/150	10.2000		RFC 58 LZP4	A193		1,6	
	2.0 T.SPARK (936A3B)	AR 36301	110/150	10.2000		RTC 62 LSDP	A199		0,6	
	2.5 V6 24V (936A2)	AR 34201	140/190	09.1998	10.2000	FN 58 LZDPR	A198		0,75	
	2.5 V6 24V (936A21)	AR 36201	138/188	10.2000		FN 58 LZDPR	A198		0,75	
	3.0 V6 24V (936A1)	AR 34301	166/226	09.1998	10.2000	FN 58 LZDPR	A198		0,75	
	3.0 V6 24V (936A11)	AR 36101	162/220	10.2000		FN 58 LZDPR	A198		0,75	
ALFASUD	1.2 Super	301.00 - 301.04 - 301.10			06.1983	C 82 LS	A40	B6	0,7	L87
	1.3 Ti Sprint Veloce	301.64	55-58/75-79		12.1984	C 82 LS	A40	B6	0,7	L87
	1.35 Ti, Ti Sprint Veloce	301.68	64/87		12.1989	C 82 LS	A40	B6	0,7	L87
	1.5 Sprint	301.98		09.1976	12.1989	C 82 LS	A40	B6	0,7	L87
	1.5 Sprint, Super, Ti, Ti Quadrifoglio	301.24 - 301.28 - 3 01.46 - 301.98	61-77/83-105	09.1976	12.1989	C 82 LS	A40	B6	0,7	L87
	1.7 ie Sprint	305.58 Cat	67/91	10.1987	12.1989	C 82 LS	A40	B6	0,7	L87
ALFETTA	2.0	013.34	94/128		06.1983	C 82 LS	A40	B6	0,7	L87
	2.0 ie	017.13	96/131		12.1984	C 62 LS	A4	B5	0,7	L65
	2.0 Quadrifoglio Verde		96/131		06.1983	C 72 L	A106		0,7	
	2.5 ie V6 L-Jetronic	016.46	116-118/158-160		12.1984	RC 62 LS	A6	B17	0,8	L65
ALFETTA GT	1.8 BN, GT	016.00 - 016.08	85-90/116-122		12.1984	RC 72 LS	A32	B26	0,7	L87
	2.0 L, GTV 2000	016.23 - 016.55	90-96/122-131		12.1984	RC 72 LS	A32	B26	0,7	L87
ARNA	1.2	305.00 - 310.00	44-50/60-68		12.1986	C 82 LS	A40	B6	0,8	L87
	1.3	310.10	63/86		12.1986	C 82 LS	A40	B6	0,8	L87
	1.35 Ti	301.68	63-64/86-87		12.1986	C 82 LS	A40	B6	0,8	L87
	1.5	305.20 - 310.16	66-70/90-95		12.1986	C 82 LS	A40	B6	0,8	L87
BRERA	2.2 JTS	939 A5.000	136/185	05.2006		FN 42 LZDPR5	A195		0,9	
F 12	1.3	140.20	40/54	01.1954	10.1981	C 72 LS (1)	A30		0,6	L87
GIULIA	1.3 Super				10.1978	C 72 LS (1)	A30		0,7	L87
	1.6 Super				10.1978	C 72 LS (1)	A30		0,7	L87

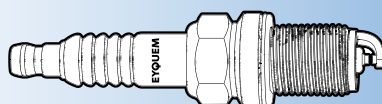

(1) Available until end of stock

(a) 30 000 km

(b) 60 000 km

(c) Grey sticker on ignition coil

(d) Green sticker on ignition coil

(e) Hex 21 mm

(f) Hex 16 mm

(g) Recommended for

cold weather



KW/HP



Box
10

Blister
4



F3-D1

ALFA ROMEO

GIULIETTA	1.3	016.44	66-70/90-95	04.1985	C 62 LS	A4	B5	0,7	L65	
	1.6	016.00	79/107	04.1985	C 62 LS	A4	B5	0,7	L65	
	1.8	016.78	87-90/118-122	04.1985	C 62 LS	A4	B5	0,7	L65	
	2.0	116.71 - 016.55	96/131	04.1985	C 82 LS	A40	B6	0,7	L87	
GIULIETTA (940) NEW	1.4 TB	940 B.1000/940 B.8000	77/105	04.2011	RZC 82 LSDPT	A535		0,85		
	NEW 1.4 BiFuel	198 A4.000	88/120	12.2011	RZC 82 LSDPT	A535		0,85		
	NEW 1.4 TB	198 A4.000/940 B7.000	88/120	04.2010	RZC 82 LSDPT	A535		0,85		
	NEW 1.4 TB	940 A2.000	125/170	04.2010	RZC 82 LSDPT	A535		0,85		
GT	1.3			12.1977	C 72 LS (1)	A30		0,7	L87	
	1.6			12.1977	C 72 LS (1)	A30		0,7	L87	
GTA	1.3			12.1977	C 82 LS	A40	B6	0,7	L87	
GTV	2.0	062.12	94/128	01.1985	12.1985	C 82 LS	A40	B6	0,8	L87
	2.0	016.55	96/131	07.1978	01.1986	C 62 LS	A4	B5	0,7	L65
	2.0 ie V6 Turbo	16.202	148/202	04.1995		C 82 LS	A40	B6	0,8	L87
	2.0 Turbo Turbo Delta	116.42	111/151	05.1979	12.1981	C 72 LS (1)	A30		0,7	L87
	2.5 ie V6	016.46	116-118/158-160	11.1980	08.1990	C 62 LS	A4	B5	0,7	L65
	2.0 T.SPARK 16V (916.C2_, 916C2C00)	AR 16201/AR 32310	110/150	06.1995		RFC 58 LZP4	A193		1,6	
	2.0 T.SPARK 16V (916.C2_, 916C2C00)	AR 16201/AR 32310	110/150	06.1995		RTC 62 LSDP	A199		0,6	
	2.0 T.SPARK 16V (916C2C)	AR 32301	114/155	05.1998	08.2000	RFC 58 LZP4	A193		1,6	
	2.0 T.SPARK 16V (916C2C)	AR 32301	114/155	05.1998	08.2000	RTC 62 LSDP	A199		0,6	
	3.0 V6 24V (916.C1)	AR 16102	162/220	10.1996	10.2000	FN 58 LZDPR	A198		0,75	
	3.0 V6 24V (916.C1B_)	AR 16105	160/218	10.2000		FN 58 LZDPR	A198		0,75	
	JUNIOR ZAGATO	1.6			12.1976	C 72 LS (1)	A30		0,7	L87
MITO	1.4	955 A9.000	51/69	05.2011		RZC 62 LSE	A510		1,0	
	1.4	350 A1.000	57/78	03.2011		RZC 62 LSE	A510		1,0	
	1.4	199 A1.000/199 A6.000	70/95	09.2008		RZC 62 LSE	A510		1,0	
	1.4	955 A1.000	58/79	09.2008		RZC 62 LSE	A510		1,0	
	1.4	955 A6.000	77/105	08.2010		RZC 58 LS	A190	B59	0,9	
	NEW 1.4	198 A4.000	88/120	09.2008		RZC 82 LSDPT	A535		0,85	
	NEW 1.4 Bifuel	198 A4.000	88/120	07.2011		RZC 82 LSDPT	A535		0,85	
	NEW 1.4 TB	955 A.2000/955 A.7000	99/135	10.2009		RZC 82 LSDPT	A535		0,85	
	NEW 1.4 TB	199 A.8000	114/155	09.2008		RZC 82 LSDPT	A535		0,85	
	NEW 1.4 TB	955 A.8000	120/163	10.2009		RZC 82 LSDPT	A535		0,85	
NEW 1.4 TB	940 A2.000	125/170	10.2009		RZC 82 LSDPT	A535		0,85		
MONTREAL	2.6	AR 10832	106/144	12.1972	03.1979	C 82 LS	A40	B6	0,7	L87
NUEVA GIULIA	1.3			12.1979	RC 72 LS	A32	B26	0,7	L87	
	1.6			12.1979	RC 72 LS	A32	B26	0,7	L87	
RZ	3.0 V6 Zagato	615.01	152/207	01.1992	12.1994	C 82 LS	A40	B6	0,8	L87
SPIDER	1.3 Junior 1300	005.36	80/109	05.1968	10.1978	C 82 LS	A40	B6	0,7	L87
	1.6	005.26 - 015.63	75-80/102-109	11.1979	12.1994	C 82 LS	A40	B6	0,7	L87
	1.6 Junior 1600	005.26	75-80/102-109	06.1971	10.1979	C 82 LS	A40	B6	0,7	L87
	2.0	005.15	92-94/125-128	04.1971	12.1989	C 62 LS	A4	B5	0,7	L65
	2.0 ie	015.44 - 015.88 - 015.90	85-93/116-126	10.1981	12.1994	C 62 LS	A4	B5	0,7	L65
	2.0 ie Veloce 2000	016.84		01.1972	12.1980	C 82 LS	A40	B6	0,7	L87
	SPIDER II	2.0 ie V6 Turbo	16.202	148/202	06.1998		C 82 LS	A40	B6	0,7
2.0 T.SPARK 16V (916S2B)		AR 32301	114/155	05.1998	08.2000	RFC 58 LZP4	A193		1,6	
2.0 T.SPARK 16V (916S2B)		AR 32301	114/155	05.1998	08.2000	RTC 62 LSDP	A199		0,6	
2.0 T.SPARK 16V (916S2C00)		AR 16201/AR 32310	110/150	06.1995	04.2005	RFC 58 LZP4	A193		1,6	
2.0 T.SPARK 16V (916S2C00)		AR 16201/AR 32310	110/150	06.1995	04.2005	RTC 62 LSDP	A199		0,6	
3.0 ie V6		16.101 - 19.199	141/192	04.1995	05.1998	RC 72 LS	A32	B26	0,7	L87
3.0 V6 24V		AR 16102	162/220	01.1999	10.2000	FN 58 LZDPR	A198		0,75	
SZ	3.0 V6 Zagato	615.01	152/207	09.1988	08.1994	C 82 LS	A40	B6	0,8	L87

ALPINA

B3	2.7	C2/2 - C2/4 Cat	143-150/194-204	08.1987	06.1992	C 62 LS	A4	B5	0,7	L65
B6	2.8 L6	B6 Cat	160/218	09.1981	01.1983	C 62 LS	A4	B5	0,7	L65
	2.8 L6	B6/2 Cat	154/209	03.1984	07.1986	C 62 LS	A4	B5	0,7	L65
	3.5 L6	B10/2-3-4-5 Cat	176-187/239-254	11.1985	07.1987	C 62 LS	A4	B5	0,7	L65
	3.5 L6	B10/6 Cat	187/254	05.1988		C 62 LS	A4	B5	0,7	L65
B9	3.5 L6 Coupé	B9 - B9/1 Cat	180/245	11.1981	12.1985	C 62 LS	A4	B5	0,7	L65
B10	3.5 L6	B11/3 Cat	187/254	04.1988		C 62 LS	A4	B5	0,7	L65
	3.5 L6 Coupé	B10 Cat	192/261	07.1985	12.1987	C 62 LS	A4	B5	0,7	L65
B11	3.5 L6	B11/1-3 Cat	176-187/239-254	01.1987	09.1987	C 62 LS	A4	B5	0,7	L65
C1	2.3 L6	C1 - C1/1 Cat	125/170	04.1980	11.1985	C 62 LS	A4	B5	0,7	L65
	2.5	C2/3 Cat	140/190	10.1986	07.1987	C 62 LS	A4	B5	0,7	L65

(f) Available until end of stock

(a) 30 000 km

(b) 60 000 km

(c) Grey sticker on ignition coil

(d) Green sticker on ignition coil

(e) Hex 21 mm

(f) Hex 16 mm

(g) Recommended for cold weather

(g) Recommended for cold weather



EYQUEM



Box 10
Blister 4



F3 → 1

ALPINA										
C2	2.5	C2 Cat	136/185	07.1986	11.1986	C 62 LS	A4	B5	0,7	L65
	2.7	C2/1-2-4 Cat	143-154/194-209	04.1986	07.1987	C 62 LS	A4	B5	0,7	L65

ALPINE										
1300	1.3		54/73	01.1974	12.1975	C 62 S	A55		0,7	
	1.3 85		60/82	01.1970	12.1973	805 LP	A79		0,7	
1.6 SC -SI	1600		93/126	01.1973	12.1975	805 LP	A79		0,7	
	1600		103/140	01.1973	12.1975	805 LP	A79		0,7	
A110	1100		70/95	01.1968	12.1970	C 42 S	A12	B7	0,7	N43
A310	1.6		93/126	01.1971	12.1977	C 82 LS	A40	B6	0,7	L87
	1.6 injection		94/128	01.1976	12.1977	805 LP	A79		0,7	
	2.7	112 (730-731)	110/150	01.1976	12.1984	C 62 LJS	A19	B2	0,6	J65
A610	3.0 Turbo	Z7X-744	184/250	01.1991	04.1995	FC 82 LS 3	A84		1,0	
Berlinette	1600 SX		70/95	01.1976	12.1977	C 72 LS (1)	A30		0,6	L87
V6	2.5 Turbo	Z7U-730-732-734	136/185	01.1985	12.1990	805 LJSP	A96		0,65	
	2.5 Turbo	Z7U-730-732-734	147/200	01.1988	12.1990	805 LJSP	A96		0,65	
	2.9 GT	Z6W	116/160	01.1985	12.1990	C 82 LJS	A52		0,9	J87

ARO										
10	1.4	IAP 810-R-99	46/63	09.1988		C 42 S	A12	B7	0,8	N43
	1.6		55/75	09.1988		C 52 LS	A1	B1	0,7	L65
240-244	2.5 240, 241, 242, 243, 244, 246	L 25		01.1978		RC 62 S	A95		0,8	
SERIE 100	1.4 100, 101, 103, 104			01.1978		C 42 S	A12	B7	0,8	N43

ASIA										
ROCSTA	1.8 i 4x4	F8	57/78	01.1994		RC 52 LS	A9	B20	0,8	L65

ASTON-MARTIN										
DB6	4.0					RC 62 LS	A6	B17	0,8	L65
DB7	3.2 i L6 24V Tu	AJ6.4 Compressor [DOHC]	250/340	03.1994		RFN 62 LZ	A71		0,8	F86
LAGONDA	5.3 i V8 Bi-Turbo		410/558	01.1994		RFC 82 LS	A76		0,6	F86
	5.3 V8	[OHC] Cat	178-230/242-313	01.1976	06.1990	RC 62 LS	A6	B17	0,8	L65
VIRAGE	5.3 i V8 32V	[DOHC]	246/335	10.1988		RFN 58 LZ (b)	A7	B28	0,8	F54
	5.3 i V8 32V	[DOHC]	246/335	10.1988		RFN 58 LZ3A (g)	A515		0,8	
ZAGATO	5.3 i V8	[OHC]	318/432	01.1986		RC 72 LS	A32	B26	0,8	L87

AUDI										
50	1.1	HB - HD	37-38/50-52	08.1974	07.1978	C 62 LS	A4	B5	0,7	L65
	1.1	HC	44/60	08.1974	07.1978	C 82 LS	A40	B6	0,7	L87
	1.3	HH	44/60	08.1977	07.1978	C 62 LS	A4	B5	0,7	L65
60	1.5- Variant	10-8910	40/54	09.1968	08.1972	C 62 LS	A4	B5	0,7	L65
75	1.7- Variant	ZG	55/75	09.1968	08.1972	C 62 LS	A4	B5	0,7	L65
80	1.3	FY-ZA-ZF	40-44/55-60	05.1972	07.1981	C 62 LS	A4	B5	0,7	L65
	1.3	EP	44/60	09.1978	07.1986	C 52 LS3X	A28	B25	0,9	L65
	1.4	SE	48/65	08.1987	08.1991	C 52 LS3X	A28	B25	0,9	L65
	1.5	YJ - ZB - ZC	55-63/75-86	05.1972	12.1975	C 72 LS (1)	A30		0,7	L87
	1.6	YG	63/86	01.1975	07.1983	C 62 LS	A4	B5	0,7	L65
	1.6	YH	63/86	01.1975	07.1983	C 62 LS	A4	B5	0,7	L65
	1.6	FS	53/72	02.1976	08.1979	C 62 LS	A4	B5	0,7	L65
	1.6	YY	51/69	02.1979	07.1981	C 62 LS	A4	B5	0,7	L65
	1.6	YK	63/86	08.1977	08.1979	C 62 LS	A4	B5	0,7	L65
	1.6	WP	48/65	08.1979	01.1982	C 62 LS	A4	B5	0,7	L65
	1.6	WV - WVA	51-55/70-75	08.1981	07.1983	C 62 LS	A4	B5	0,7	L65
	1.6	RNA	51/69	08.1983	08.1991	C 52 LS3X	A28	B25	0,9	L65
	1.6	DT	51-55/70-75	08.1983	07.1986	C 52 LS3X	A28	B25	0,9	L65
	1.6	SA	53/72	08.1983	08.1986	C 52 LS3X	A28	B25	0,9	L65
	1.6	JU	55/75	08.1983	08.1991	C 52 LS3X	A28	B25	0,9	L65
	1.6	PP	51/69	08.1987	09.1991	RC 52 LZ3EX	A35		0,9	L65
	1.6	YT	51/69	09.1975	07.1979	C 62 LS	A4	B5	0,7	L65
1.6	YN	55/75	09.1975	07.1986	C 62 LS	A4	B5	0,7	L65	
1.6	YP	63/86	09.1975	02.1983	C 62 LS	A4	B5	0,7	L65	
1.6	WY - WZ	55/75	09.1979	07.1983	C 52 LS	A1	B1	0,7	L65	
1.6	RN	51-55/70-75	09.1986	08.1991	C 52 LS3X	A28	B25	0,9	L65	
	1.6 GLE, GTE	YS	81/110	01.1976	07.1982	C 82 LS	A40	B6	0,7	L87
	1.6 GLE, GTE	YZ	81/110	01.1976	12.1986	C 82 LS	A40	B6	0,7	L87

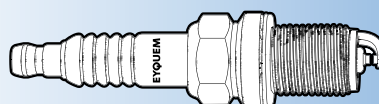

(1) Available until end of stock
(a) 30 000 km
(b) 60 000 km
(c) Grey sticker on ignition coil
(d) Green sticker on ignition coil

(e) Hex 21 mm
(f) Hex 16 mm
(g) Recommended for cold weather



KW/HP



Box
10

Blister
4



F3-1

AUDI

	1.6 GT	XX	74/101	10.1973	08.1976	C 82 LS	A40	B6	0,7	L87
	1.6 i	DTA	51-55/70-75	08.1983	08.1991	C 52 LS3X	A28	B25	0,9	L65
	1.6 i	ABB	75/102	08.1990	01.1996	C 62 LS3X	A13	B15	0,8	L65
	1.6 i	ABM	52/71	09.1991	12.1994	RC 52 LZ3EX	A35		0,9	L65
	1.6 i E	ADA	74/101	06.1993	12.1994	RC 58 LZ3EX	A34	B54	0,9	L65
	1.7	8920	59/80	09.1966	08.1968	RC 72 L	A114		0,7	
	1.7	WT	58/79	08.1980	07.1983	C 62 LS	A4	B5	0,7	L65
	1.8 E, GTE	DS	66/90	08.1983	08.1988	C 62 LS3X	A13	B15	0,8	L65
	1.8 E, GTE, GTE Quattro, Quattro	MU	82/112	03.1985	08.1986	C 62 LS3X	A13	B15	0,8	L65
	1.8 E, GTE, GTE Quattro, Quattro	JV	66/90	08.1983	10.1991	C 62 LS3X	A13	B15	0,8	L65
	1.8 E, GTE, GTE Quattro, Quattro	JN	66/90	09.1986	07.1990	C 62 LS3X	A13	B15	0,8	L65
	1.8 i	RU	55/75	10.1986	01.1990	C 52 LS3X	A28	B25	0,9	L65
	1.8 i, Quattro	SF	65/88	02.1986	08.1991	RC 58 LZ3EX	A34	B54	0,9	L65
	1.8 i E, GTE, GTE Quattro, Quattro	NE - DZ	66-82/90-112	09.1986	08.1991	C 62 LS3X	A13	B15	0,8	L65
	1.8 i E, GTE, GTE Quattro, S, S Quattro	PM	66/90	09.1986	10.1991	C 62 LS3X	A13	B15	0,8	L65
	1.8 i GTE, GTE Quattro	PV	81/110	08.1985	07.1986	C 62 LS3X	A13	B15	0,8	L65
	1.8 i S, S Quattro	SF	65/88	09.1986	08.1991	C 62 LS3X	A13	B15	0,8	L65
	1.8 i S, S Quattro, CC Quattro	NE	66/90	09.1986	08.1991	C 62 LS3X	A13	B15	0,8	L65
	1.8 S	JV	66/90	08.1983	10.1991	C 62 LS3X	A13	B15	0,8	L65
	1.8 S, S Quattro, CC Quattro	JN	66/90	09.1986	08.1991	C 62 LS3X	A13	B15	0,8	L65
	1.9 CD-5S	WN	85/115	09.1981	08.1983	C 82 LS	A40	B6	0,7	L87
	1.9 i, Quattro	SD	83/113	09.1986	07.1988	C 62 LS3X	A13	B15	0,8	L65
	2.0 5E	JL	81/110	08.1983	07.1988	C 62 LS3X	A13	B15	0,8	L65
	2.0 5E	HP	85/115	08.1983	07.1985	C 62 LS3X	A13	B15	0,8	L65
	2.0 i	ABT	66/90	09.1991	12.1994	RC 58 LZ3EX	A34	B54	0,9	L65
	2.0 i	SK	83/113		07.1986	C 62 LS3X	A13	B15	0,8	L65
	2.0 i, Quattro	AAD	85/115	12.1990	12.1992	C 62 LS3X	A13	B15	0,8	L65
	2.0 i 16V, Quattro	6A	101-103/137-140	03.1990	09.1991	RFC 62 LZ3EX	A86		0,9	F86
	2.0 i 16V, Quattro	ACE	103/140	04.1992	12.1994	RFC 62 LZ3EX	A86		0,9	F86
	2.0 i 5E, Quattro	JS	85/115	08.1983	09.1984	C 62 LS3X	A13	B15	0,8	L65
	2.0 i E	ABK	85/115	07.1992	01.1996	RC 58 LZ3EX	A34	B54	0,9	L65
	2.0 i E, E Quattro	ABK	85/115	08.1991	12.1994	RC 58 LZ3EX	A34	B54	0,9	L65
	2.0 i E, Quattro, E Quattro	3A	83/113	08.1988	07.1991	C 62 LS3X	A13	B15	0,8	L65
	2.0 i Quattro	PS	85/115	04.1987	10.1991	RC 58 LZ3EX	A34	B54	0,9	L65
	2.0 i Quattro	AAE	74/101	12.1990	10.1994	RC 58 LZ3EX	A34	B54	0,9	L65
	2.0 i Quattro	ADW	79/107	12.1993	01.1996	RC 58 LZ3EX	A34	B54	0,9	L65
	2.1 i L5 Quattro	KK	100/136	11.1982	07.1984	C 72 LS3X	A63		0,8	L87
	2.1 L5 5E	WE	79-85/107-115	03.1977	08.1983	C 62 LS	A4	B5	0,7	L65
	2.2 Quattro	KL	96/131	09.1982	07.1984	C 72 LS (1)	A30		0,7	L87
	2.3 i E, E Quattro	NG Cat	98-100/133-136	09.1991	12.1994	RC 52 LZ3EX	A35		0,9	L65
	2.6 i V6, Quattro	ABC	110/150	07.1992	12.1994	RFC 58 LZ3EX	A58	B55	0,9	F54
	2.6 i V6 Quattro	ACZ	106/144	03.1993	01.1996	RFC 58 LZ3EX	A58	B55	0,9	F54
	2.8 i V6 E, E Quattro	AAH	128/174	09.1991	12.1994	RFC 58 LZ3EX	A58	B55	0,9	F54
90	2.0	JL	81/110	10.1984	07.1988	C 62 LS3X	A13	B15	0,8	L65
	2.0	HP	85/115	10.1984	03.1987	C 62 LS3X	A13	B15	0,8	L65
	2.0 i	SK	83/113	03.1986	03.1987	C 62 LS3X	A13	B15	0,8	L65
	2.0 i	PS	85/115	07.1988	09.1991	RC 58 LZ3EX	A34	B54	0,9	L65
	2.0 i	JS	85/115	08.1984	03.1987	C 62 LS3X	A13	B15	0,8	L65
	2.0 i	3A	83-85/113-115	09.1987	10.1990	C 62 LS3X	A13	B15	0,8	L65
	2.0 i 20V, Quattro	NM	118/160	01.1988	09.1991	FC 62 LS3X	A57		0,9	F86
	2.2 i L5	KX	85/115	01.1985	03.1987	C 62 LS3X	A13	B15	0,8	L65
	2.2 i L5	HY	100/136	08.1984	10.1991	C 72 LS3X	A63		0,8	L87
	2.2 i L5, E, E Quattro	KV	100/136	08.1984	10.1991	C 72 LS3X	A63		0,8	L87
	2.2 i L5 E Quattro	JT	88/120	08.1985	03.1987	C 62 LS3X	A13	B15	0,8	L65
	2.3 E 20V Quattro	7A	123/167	04.1990	09.1991	RFC 62 LZ3EX	A86		0,9	F86
	2.3 i 20V, Quattro	7A	125/170	06.1988	09.1991	RFC 62 LZ3EX	A86		0,9	F86
	2.3 i E, E Quattro	NG Cat	98-100/133-136	04.1987	12.1991	RC 52 LZ3EX	A35		0,9	L65
	2.8 i V6 Quattro	AAH - AFC	128/174	01.1992	06.1995	RFC 58 LZ3EX	A58	B55	0,9	F54
100	1.6, Avant	YV - YM	63/86	08.1974	02.1983	C 62 LS	A4	B5	0,7	L65
	1.6 i	ABB	75/102	08.1990	07.1994	C 62 LS3X	A13	B15	0,8	L65
	1.8	ZV	59/80	11.1968	11.1971	C 82 LS	A40	B6	0,7	L87
	1.8	ZU -ZX- ZM	63-79/85-107	08.1968	07.1976	C 72 LS (1)	A30		0,8	L87
	1.8, Avant	DR	55/75	08.1982	10.1986	C 52 LS3X	A28	B25	0,9	L65
	1.8, Avant	RS	55/75	08.1982	12.1987	C 52 LS3X	A28	B25	0,9	L65
	1.8, Avant	DS	66/90	09.1982	12.1990	C 62 LS3X	A13	B15	0,8	L65

(f) Available until end of stock

(a) 30 000 km

(b) 60 000 km

(c) Grey sticker on ignition coil

(d) Green sticker on ignition coil

(e) Hex 21 mm

(f) Hex 16 mm

(g) Recommended for

cold weather



EYQUEM



Box 10
Blister 4



F3 → 1

AUDI										
	1.8, LS	ZZ	74/101	08.1968	07.1976	C 72 LS (1)	A30		0,8	L87
	1.8, Quattro	SH	65/88	02.1986	07.1988	RC 58 LZ3EX	A34	B54	0,9	L65
	1.8, Quattro	JW	66/90	09.1982	12.1990	C 62 LS3X	A13	B15	0,8	L65
	1.8 i Avant, Quattro	DS- SF - NP - 4B - PH	66/90	09.1982	12.1990	C 62 LS3X	A13	B15	0,8	L65
	1.9	ZJ - ZL - ZY	74-82/100-112	08.1968	07.1976	C 72 LS (1)	A30		0,8	L87
	1.9	ZP	85/115	07.1970	07.1971	C 82 LS	A40	B6	0,7	L87
	1.9 5S, Avant	WH	74/101	08.1980	07.1982	C 72 LS (1)	A30		0,8	L87
	2.0, Avant	WA	85/115	06.1976	07.1980	C 82 LS	A40	B6	0,7	L87
	2.0 i	RT	85/115	01.1988	12.1992	RC 58 LZ3EX	A34	B54	0,9	L65
	2.0 i, Avant	SL	83/113	02.1986	12.1987	C 62 LS3X	A13	B15	0,8	L65
	2.0 i, Avant	KP	85/115	08.1984	12.1987	C 62 LS3X	A13	B15	0,8	L65
	2.0 i, Avant	AAE	74/101	12.1990	06.1994	RC 58 LZ3EX	A34	B54	0,9	L65
	2.0 i, Quattro	AAD	85/115	12.1990	12.1992	RC 58 LZ3EX	A34	B54	0,9	L65
	2.0 i 16V, Quattro	ACE	103/140	04.1992	06.1994	RFC 62 LZ3EX	A86		0,9	F86
	2.0 i E, E Avant	ABK	85/115	12.1990	06.1994	RC 58 LZ3EX	A34	B54	0,9	L65
	2.0 i Quattro	ADW	79/107	12.1993	07.1994	RC 58 LZ3EX	A34	B54	0,9	L65
	2.0, Avant	WF	77/105	07.1977	07.1978	C 72 LS (1)	A30		0,8	L87
	2.1 i L5 5E	WC	100/136	03.1977	07.1984	C 72 LS3X	A63		0,8	L87
	2.1 i L5 Avant	WG	100/136	01.1977	07.1980	C 72 LS (1)	A30		0,8	L87
	2.1 i Turbo Avant, Quattro	KH	104/141	08.1986	12.1990	C 62 LS3X	A13	B15	0,8	L65
	2.1 L5	WE	79-85/107-115	03.1977	02.1983	C 62 LS	A4	B5	0,7	L65
	2.1 L5, Avant	KF	96/131	02.1982	09.1984	C 72 LS3X	A63		0,8	L87
	2.1 L5 5S, Avant	WB	85/115	10.1977	07.1984	C 72 LS (1)	A30		0,8	L87
	2.2	WU	79/107	08.1982	08.1984	RC 62 LS	A6	B17	0,8	L65
	2.2 i L5, Avant	KZ	85/115	08.1984	09.1986	C 62 LS3X	A13	B15	0,8	L65
	2.2 i L5, Quattro	KU	101/138	08.1984	12.1988	C 72 LS3X	A63		0,8	L87
	2.2 i L5 E Quattro, E Quattro Avant	PX	88/120	08.1985	07.1986	C 62 LS3X	A13	B15	0,8	L65
	2.2 i Turbo, Quattro	MC	121/165	08.1986	11.1990	C 62 LS3X	A13	B15	0,8	L65
	2.2 L5, Quattro	HX	101/138	10.1983	12.1990	C 72 LS3X	A63		0,8	L87
	2.3 i E, E Quattro	NF	100/136	11.1986	11.1990	C 62 LS3X	A13	B15	0,8	L65
	2.3 i E, E Quattro	AAR	98/133	12.1990	06.1994	RC 52 LZ3EX	A35		0,9	L65
	2.6 i V6, Quattro	ABC	110/150	04.1992	06.1994	RFC 58 LZ3EX	A58	B55	0,9	F54
	2.6 i V6, Quattro	ACZ	106/144	07.1993	06.1994	RFC 58 LZ3EX	A58	B55	0,9	F54
	2.8 i V6, Quattro	AAH	128/174	09.1991	06.1994	RFC 58 LZ3EX	A58	B55	0,9	F54
	4.2 i V8 32V, Quattro, S4	ABH	206/280	10.1992	06.1994	RC 52 LJS4E	A155		1,6	
200	2.1 i L5 5E	WC	100/136	08.1979	07.1984	C 72 LS3X	A63		0,8	L87
	2.1 i Turbo	KH	100/136	08.1979	07.1987	C 72 LS3X	A63		0,8	L87
	2.1 5T	WJ	125/170	10.1979	08.1982	C 82 LS3X	A92		0,8	L87
	2.1 Turbo, Quattro	KG	134/182	08.1983	01.1988	C 72 LS3X	A63		0,8	L87
	2.1 Turbo Quattro	KG	134/182	09.1983	01.1988	C 72 LS3X	A63		0,8	L87
	2.1 Turbo Turbo Quattro	JY	134/182	08.1983	07.1986	C 72 LS3X	A63		0,8	L87
	2.2 i L5	KU	101/138	08.1979	07.1987	C 72 LS3X	A63		0,8	L87
	2.2 i Turbo, Quattro	1B - 2B	140-147/190-200	02.1988	12.1990	C 62 LS3X	A13	B15	0,8	L65
	2.2 i Turbo, Quattro	MC	121/165	08.1985	12.1991	C 62 LS3X	A13	B15	0,8	L65
	2.3 i	NF	100/136	11.1986	09.1991	C 62 LS3X	A13	B15	0,8	L65
A1 (8X1,8XF)	NEW 1.0 TFSI	CHZE	60/82	01.2016		ZN 62 LSDPFRSO	A538		0,75	
	NEW 1.0 TFSI	CHZB	70/95	03.2015		ZN 62 LSDPFRSO	A538		0,75	
	1.2 TFSI	CBZA	63/86	05.2010		FC 62 LSDPR	A522		0,9	
	1.4 TFSI	CAXA/CNVA	90/122	05.2010		FC 62 LSDPR	A522		0,9	
	NEW 1.4 TFSI	CZCA/CZDB	92/125	11.2014		ZN 62 LSDPFRSO	A538		0,75	
	NEW 1.4 TFSI	CPTA	103/140	04.2012		ZN 62 LSDPFRSO	A538		0,75	
	NEW 1.4 TFSI	CZEA	110/150	11.2014		ZN 62 LSDPFRSO	A538		0,75	
	1.4 TFSI	CAVG/CTHG/CTJA	136/185	01.2011		FC 62 LSDPR	A522		0,9	
	2.0 TFSI quattro	CDLH	188/256	03.2012		FN 68 LZDPR	A523		0,7	
A1 (8X1,8XK)	NEW 1.2 TFSI	CBZA	63/86	05.2010		FN 68 LZIPFRS	A548		0,7	
	NEW 1.4 TFSI	CAVG/CTHG/CTJA	136/185	01.2011		FN 72 LZIPFRS	A551		0,7	
	NEW 1.8 TFSI	DAJB	141/192	02.2015		FN 72 HZIPRSO	A537		0,75	
	NEW S1 quattro	CWZA	170/231	03.2014		FN 72 HZIPRSO	A537		0,75	
A1 Sportback (8XA,8XF)	NEW 1.0 TFSI	CHZE	60/82	01.2016		ZN 62 LSDPFRSO	A538		0,75	
	NEW 1.0 TFSI	CHZB	70/95	03.2015		ZN 62 LSDPFRSO	A538		0,75	
	NEW 1.2 TFSI	CBZA	63/86	01.2012		FN 68 LZIPFRS	A548		0,7	
	NEW 1.4 TFSI	CZCA/CZDB	92/125	11.2014		ZN 62 LSDPFRSO	A538		0,75	
	NEW 1.4 TFSI	CPTA	103/140	04.2012		ZN 62 LSDPFRSO	A538		0,75	
	NEW 1.4 TFSI	CZEA	110/150	11.2014		ZN 62 LSDPFRSO	A538		0,75	

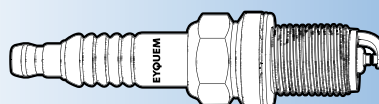

(1) Available until end of stock

- (a) 30 000 km
- (b) 60 000 km
- (c) Grey sticker on ignition coil
- (d) Green sticker on ignition coil

- (e) Hex 21 mm
- (f) Hex 16 mm
- (g) Recommended for cold weather



KW/HP



Box
10

Blister
4



F3

AUDI

	NEW	1.4 TFSI	CAVG/CTHG/CTJA	136/185	11.2011		FN 72 LZPFRS	A551		0,7
	NEW	1.8 TFSI	DAJB	141/192	02.2015		FN 72 HZIPRSO	A537		0,75
	NEW	S1 quattro	CWZA	170/231	03.2014		FN 72 HZIPRSO	A537		0,75
A1 Sportback (8XA,8XK)		1.2 TFSI	CBZA	63/86	01.2012		FC 62 LSDPR	A522		0,9
		1.4 TFSI	CAXA/CNVA	90/122	11.2011		FC 62 LSDPR	A522		0,9
	NEW	1.4 TFSI	CZCA	92/125	11.2014		ZN 62 LSDPFRSO	A538		0,75
	NEW	1.4 TFSI	CPTA	103/140	04.2012		ZN 62 LSDPFRSO	A538		0,75
	NEW	1.4 TFSI	CZEA	110/150	11.2014		ZN 62 LSDPFRSO	A538		0,75
		1.4 TFSI	CAVG/CTHG/CTJA	136/185	11.2011		FC 62 LSDPR	A522		0,9
	NEW	S1 quattro	CWZA	170/231	03.2014		FN 72 HZIPRSO	A537		0,75
A2		1.4 i 16V	AUA - BBY [DOHC]	55/75	02.2000	08.2005	RFC 58 LZ3EX	A58	B55	0,9 F54
		1.4 i 16V	AFH	74/101	03.1997		RFC 58 LZ3EX	A58	B55	0,9 F54
		1.4 i 16V	AUA [DOHC]	55/75	09.1999		RFC 58 LZ3EX	A58	B55	0,9 F54
		1.6 FSI	BAD	81/110	05.2002	08.2005	RFC 62 LS4GF6	A511		1,3
		1.6 i	APF	74/101	03.1999	08.2000	RFC 58 LZ3EX	A58	B55	0,9 F54
		1.6 i	AKL	74/101	08.1997	08.2000	RFC 58 LZ3EX	A58	B55	0,9 F54
		1.6 i	AVU	75/102	08.2000		RFN 52 LZDPF5	A153		1,0
		1.6 i	AEH [OHC]	74/101	09.1996	08.2000	RFC 58 LZ3EX	A58	B55	0,9 F54
		1.8 i 20V	APG [DOHC]	92/125	11.1999		RFC 58 LZ3EX	A58	B55	0,9 F54
		1.8 i 20V Ambiente, Attraction, Quattro	AGN [DOHC]	92/125	09.1996		RFC 58 LZ3EX	A58	B55	0,9 F54
		1.8 T 20V	AQA [DOHC]	110/150	08.1998		RFC 58 LZ3EX	A58	B55	0,9 F54
		1.8 T 20V	ARY [DOHC]	132/180	10.1998		RFC 58 LZ3EX	A58	B55	0,9 F54
		1.8 T 20V	AUM [DOHC]	110/150	12.1996		RFC 58 LZ3EX	A58	B55	0,9 F54
		1.8 T 20V, Quattro	ARZ [DOHC]	110/150	08.1998		RFC 58 LZ3EX	A58	B55	0,9 F54
		1.8 T 20V, Quattro	AJQ - APP - AUQ [DOHC]	132/180	10.1998		RFC 58 LZ3EX	A58	B55	0,9 F54
		1.8 T 20V, Quattro	ARX [DOHC]	110/150	12.1996		RFC 58 LZ3EX	A58	B55	0,9 F54
		1.8 T 20V Ambiente, Ambition, Quattro	AGU [DOHC]	110/150	12.1996		RFC 58 LZ3EX	A58	B55	0,9 F54
A3		1.2 TSI	CBZB	77/105	04.2010	08.2012	FC 62 LSDPR	A522		0,9
		1.4 TFSI	CAXC/CMSA	92/125	09.2007	08.2012	FC 62 LSDPR	A522		0,9
		1.6	AEH/AKL/APF	74/101	09.1996	05.2003	RFC 58 LZ3EX	A58	B55	1,0 F54
		1.6	BGU/BSE/BSF	75/102	05.2003	08.2012	RFC 58 LZ3EX	A58	B55	1,0 F54
		1.6	AVU/BFQ	75/102	08.2000	05.2003	RFC 58 LZ3EX	A58	B55	1,0 F54
		1.6 FSI	BLF/BLP/BAG	85/115	08.2003	09.2007	RFC 62 LS4GF6	A511		1,3
		1.8	AGN/APG	92/125	09.1996	05.2003	RFC 58 LZ3EX	A58	B55	1,0 F54
		1.8 T	ARZ, AQA, AGU, AUM	110/150	12.1996	05.2003	FN 58 LZDPR	A198		0,75
		1.8 T	AJQ, APP, ARY, AUQ	132/180	12.1998	05.2003	FN 58 LZDPR	A198		0,75
		1.8 T quattro	AJQ, ARY	132/180	10.1998	05.2003	FN 58 LZDPR	A198		0,75
		1.8 T quattro	ARX, AQA, AGU	110/150	12.1996	05.2003	FN 58 LZDPR	A198		0,75
		1.8 TFSI	BYT/BZB/CDA	118/160	11.2006	08.2012	FN 68 LZDPR	A523		0,7
		1.8 TFSI quattro	CDAA	118/160	07.2008	08.2012	FN 68 LZDPR	A523		0,7
		2.0 FSI	AWA, AXW, BLX, BLR	110/150	07.2002	06.2008	FN 62 LZFDPR2A	A192		1,1
		2.0 FSI	BLY	110/150	05.2003		RFN 58 LZDP5	A187		1,1
		2.0 FSI	BMB	110/150	05.2003		RFN 58 LZDP5	A187		1,1
		2.0 FSI	BVZ	110/150	05.2003		RFN 58 LZDP5	A187		1,1
		2.0 TFSI	CAWB/AXX/BWA/CCZA	147/200	09.2004	08.2012	FN 68 LZDPR	A523		0,7
		2.0 TFSI quattro	AXX/BWA/CCZA	147/200	09.2004	08.2012	FN 68 LZDPR	A523		0,7
		2.0 S3 quattro	BZC/CDLC	188/256	02.2007	08.2012	FN 68 LZDPR	A523		0,7
		2.0 S3 quattro	BHZ/CDLA	195/265	11.2006	08.2012	FN 68 LZDPR	A523		0,7
		S3 quattro	AMK/APY/AUL	154/209	03.1999	04.2002	FN 58 LZDPR	A198		0,75
		S3 quattro	BAM	165/224	10.2001	05.2003	FN 58 LZDPR	A198		0,75
A3 (8P1)	NEW	1.2 TSI	CBZB	77/105	04.2010	08.2012	FN 68 LZPFRS	A548		0,7
A3 (8V1, 8VK)	NEW	1.2 TFSI	CJZA	77/105	02.2013		ZN 62 LSDPFRSO	A538		0,75
	NEW	1.2 TFSI	CYVB	81/110	05.2014		ZN 62 LSDPFRSO	A538		0,75
	NEW	1.4 TFSI	CMBA/CXSA	90/122	04.2012		ZN 62 LSDPFRSO	A538		0,75
	NEW	1.4 TFSI	CXSB/CZCA	92/125	05.2014		ZN 62 LSDPFRSO	A538		0,75
	NEW	1.4 TFSI	CPTA	103/140	03.2013		ZN 62 LSDPFRSO	A538		0,75
	NEW	1.4 TFSI	CZEA	110/150	05.2014		ZN 62 LSDPFRSO	A538		0,75
	NEW	1.8 TFSI	CJSA	132/180	04.2012		FN 72 HZIPRSO	A537		0,75
	NEW	1.8 TFSI quattro	CJSB	132/180	08.2012		FN 72 HZIPRSO	A537		0,75
	NEW	S3 quattro	CJXB	206/280	02.2013		FN 72 HZIPRSO	A537		0,75
	NEW	S3 quattro	CJXF	210/286	05.2014		FN 72 HZIPRSO	A537		0,75
	NEW	S3 quattro	CJXC	221/300	11.2012		FN 72 HZIPRSO	A537		0,75
A3 Cabriolet (8P7)	NEW	1.2 TFSI	CBZB	77/105	03.2010	05.2013	FN 68 LZPFRS	A548		0,7

(f) Available until end of stock

(a) 30 000 km

(b) 60 000 km

(c) Grey sticker on ignition coil

(d) Green sticker on ignition coil

(e) Hex 21 mm

(f) Hex 16 mm

(g) Recommended for cold weather



EYQUEM



Box
10

Blister
4



F3

AUDI												
A3 Cabriolet (8V7, 8VE)	NEW	1.4 TFSI	CXSB/CZCA	92/125	02.2014			ZN 62 LSDPFRSO	A538	0,75		
	NEW	1.4 TFSI	CPTA	103/140	10.2013			ZN 62 LSDPFRSO	A538	0,75		
	NEW	1.4 TFSI	CZEA	110/150	05.2014			ZN 62 LSDPFRSO	A538	0,75		
	NEW	1.8 TFSI	CNSB	125/170	05.2014	07.2016		FN 72 HZIPRSO	A537	0,75		
	NEW	1.8 TFSI	CJSA	132/180	10.2013			FN 72 HZIPRSO	A537	0,75		
	NEW	1.8 TFSI quattro	CJSB	132/180	03.2014			FN 72 HZIPRSO	A537	0,75		
	NEW	2.0 TFSI quattro	CNTC	162/220	05.2014			FN 72 HZIPRSO	A537	0,75		
	NEW	S3 quattro	CJXF	210/286	03.2014	07.2016		FN 72 HZIPRSO	A537	0,75		
	NEW	S3 quattro	CJXC	221/300	04.2014			FN 72 HZIPRSO	A537	0,75		
A3 Limousine (8VS, 8VM)	NEW	1.2 TFSI	CJZA	77/105	10.2013			ZN 62 LSDPFRSO	A538	0,75		
	NEW	1.2 TFSI	CYVB	81/110	05.2014			ZN 62 LSDPFRSO	A538	0,75		
	NEW	1.4 TFSI	CMBB/CXSA	90/122	04.2012			ZN 62 LSDPFRSO	A538	0,75		
	NEW	1.4 TFSI	CXSB/CZCA	92/125	09.2013			ZN 62 LSDPFRSO	A538	0,75		
	NEW	1.4 TFSI	CPTA	103/140	05.2013			ZN 62 LSDPFRSO	A538	0,75		
	NEW	1.4 TFSI	CZEA	110/150	05.2014			ZN 62 LSDPFRSO	A538	0,75		
	NEW	1.8 TFSI	CNSB	125/170	11.2013	08.2016		FN 72 HZIPRSO	A537	0,75		
	NEW	1.8 TFSI	CJSA/CJSB	132/180	05.2013			FN 72 HZIPRSO	A537	0,75		
	NEW	1.8 TFSI quattro	CJSB	132/180	11.2013			FN 72 HZIPRSO	A537	0,75		
	NEW	S3 quattro	CJXB	206/280	10.2013			FN 72 HZIPRSO	A537	0,75		
	NEW	S3 quattro	CJXF	210/286	05.2014	08.2016		FN 72 HZIPRSO	A537	0,75		
	NEW	S3 quattro	CJXC	221/300	10.2013			FN 72 HZIPRSO	A537	0,75		
A3 Sportback (8PA)	NEW	1.2 TFSI	CBZB	77/105	04.2010	03.2013		FN 68 LZIPFRS	A548	0,7		
A3 Sportback (8VA, 8VF)	NEW	1.2 TFSI	CJZA	77/105	05.2013			ZN 62 LSDPFRSO	A538	0,75		
	NEW	1.2 TFSI	CYVB	81/110	05.2014			ZN 62 LSDPFRSO	A538	0,75		
	NEW	1.4 TFSI	CMBB/CXSA	90/122	09.2012			ZN 62 LSDPFRSO	A538	0,75		
	NEW	1.4 TFSI	CXSB/CZCA	92/125	05.2014			ZN 62 LSDPFRSO	A538	0,75		
	NEW	1.4 TFSI	CPTA	103/140	03.2013			ZN 62 LSDPFRSO	A538	0,75		
	NEW	1.4 TFSI	CZEA	110/150	05.2014			ZN 62 LSDPFRSO	A538	0,75		
	NEW	1.4 TFSI e-tron	CUKB/CXUA	110/150	05.2014			ZN 62 LSDPFRSO	A538	0,75		
	NEW	1.4 TFSI g-tron	CPWA	81/110	11.2013			ZN 62 LSDPFRSO	A538	0,75		
	NEW	1.8 TFSI	CJSA/CJSB	132/180	09.2012			FN 72 HZIPRSO	A537	0,75		
	NEW	1.8 TFSI quattro	CJSB	132/180	05.2013			FN 72 HZIPRSO	A537	0,75		
	NEW	S3 quattro	CJXB	206/280	05.2013			FN 72 HZIPRSO	A537	0,75		
	NEW	S3 quattro	CJXF	210/286	05.2014			FN 72 HZIPRSO	A537	0,75		
	NEW	S3 quattro	CJXC	221/300	11.2012			FN 72 HZIPRSO	A537	0,75		
A4		1.6 i	ALZ [OHC]	75/102	07.2000	06.2008		RFC 58 LZ3EX	A58	B55	0,9	F54
		1.6 i, Pack Clim, Référence	ADP	74/101	01.1995	10.1996		RFC 58 LZ3EX	A58	B55	0,9	F54
		1.6 i, Pack Clim, Référence	ANA - ARM	74/101	08.1998	07.2000		RFC 58 LZ3EX	A58	B55	0,9	F54
		1.6 i, Pack Clim, Référence	AHL	74/101	10.1996	07.2000		RFC 58 LZ3EX	A58	B55	0,9	F54
		1.8 i 20V, Quattro	APT	92/125	02.1999	11.2000		RFC 58 LZ3EX	A58	B55	0,9	F54
		1.8 i 20V, Quattro	ADR	92/125	12.1995	11.2000		RFC 58 LZ3EX	A58	B55	0,9	F54
		1.8 i 20V, Quattro	ARG	92/125	01.1995	11.2000		RFC 58 LZ3EX	A58	B55	0,9	F54
		1.8 i 20V Pack Clim, Quattro	AFY	85/115	04.1995	11.2000		RFC 58 LZ3EX	A58	B55	0,9	F54
		1.8 T 20V	AVV	92/125	01.1995	09.2001		RFC 58 LZ3EX	A58	B55	0,9	F54
		1.8 T 20V, Quattro	AJL	132/180	01.1995	11.2000		FN 58 LZDPR	A198			0,75
		1.8 T 20V, Quattro	AEB/ANB/APU/ARK/AWT	110/150	01.1995	11.2000		FN 58 LZDPR	A198			0,75
		1.8, Avant quattro	ADR/APT/ARG/AVV	92/125	02.1996	09.2001		RFC 58 LZ3EX	A58	B55	0,9	F54
		1.8, Avant quattro	AFY	85/115	07.1995	09.2001		RFC 58 LZ3EX	A58	B55	1,0	F54
		1.8, quattro	ADR/APT/ARG/AVV	92/125	01.1995	11.2000		RFC 58 LZ3EX	A58	B55	0,9	F54
		1.8, quattro	AFY	85/115	04.1995	11.2000		RFC 58 LZ3EX	A58	B55	0,9	F54
		1.8 T	BFB/BKB	120/163	07.2002	12.2004		FN 58 LZDPR	A198			0,75
		1.8 T	BEX	140/190	11.2002	12.2004		FN 58 LZDPR	A198			0,75
		1.8 T	BFB	120/163	11.2004	06.2008		FN 58 LZDPR	A198			0,75
		1.8 T	AJL	132/180	12.1997	11.2000		FN 58 LZDPR	A198			0,75
		1.8 T quattro	AMB	125/170	07.2001	12.2004		FN 58 LZDPR	A198			0,75
		1.8 T quattro	BFB	120/163	07.2002	12.2004		FN 58 LZDPR	A198			0,75
		1.8 T quattro	AVJ	110/150	11.2000	07.2002		FN 58 LZDPR	A198			0,75
		1.8 T quattro	AJL	132/180	12.1997	11.2000		FN 58 LZDPR	A198			0,75
		1.8 T quattro Cabriolet	BFB	120/163	07.2002	03.2009		FN 58 LZDPR	A198			0,75
		1.8 TFSI	CABA/CDHA	88/120	01.2008			FN 68 LZDPR	A523			0,7
		1.8 TFSI	CABB/CDHB	118/160	11.2007			FN 68 LZDPR	A523			0,7

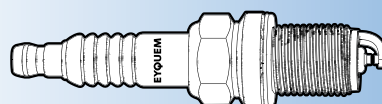

- (1) Available until end of stock
- (a) 30 000 km
- (b) 60 000 km
- (c) Grey sticker on ignition coil
- (d) Green sticker on ignition coil

- (e) Hex 21 mm
- (f) Hex 16 mm
- (g) Recommended for cold weather



KW/HP



Box
10

Blister
4



F3-1

AUDI

	1.8 TFSI quattro	CDHB	118/160	09.2008		FN 68 LZDPR	A523		0,7	
	2.0 FSI	AWA, AXW, BLX, BLR	110/150	07.2002	11.2005	FN 62 LZFDPR2A	A192		1,1	
	2.0 TFSI	BPJ, BYK	125/170	10.2006	06.2008	FN 68 LZDPR	A523		0,7	
	2.0 TFSI Cabriolet	BWE	147/200	01.2006	03.2009	FN 68 LZDPR	A523		0,7	
	2.0 TFSI quattro	BGB/BWE	147/200	11.2004	06.2008	FN 68 LZDPR	A523		0,7	
	2.0 TFSI quattro	BUL	162/220	06.2005	06.2008	FN 68 LZDPR	A523		0,7	
	2.0 TFSI	CAEA/CDNB	132/180	06.2008		FN 68 LZDPR	A523		0,7	
	2.0 TFSI flexible fuel	CFKA	132/180	11.2009		FN 68 LZDPR	A523		0,7	
	2.0 TFSI flexible fuel quattro	CFKA	132/180	11.2009		FN 68 LZDPR	A523		0,7	
	2.0 TFSI quattro	CAEB/CDNC	155/211	06.2008		FN 68 LZDPR	A523		0,7	
	2.0 TFSI quattro Allroad	CDNC/CPMA	155/211	04.2009		FN 68 LZDPR	A523		0,7	
	2.0 TFSI quattro Allroad	CPMB	162/220	05.2013		FN 68 LZDPR	A523		0,7	
	2.0 TFSI quattro	CAED, CPMB	162/220	05.2013		FN 68 LZDPR	A523		0,7	
	2.0 i	ABT - ADW - ABK	66-85/90-115	01.1995		RC 58 LZ3EX	A34	B54	0,9	L65
	2.4 (8D2,B5)	AGA- ALF- AML- APS - ARJ	121/165	03.1997	11.2000	RFC 62 LZ2	A150		1,0	F86
	2.4 (8D2,B5)	AJG- AMM - APZ	120/163	08.1997	11.2000	RFC 62 LZ2	A150		1,0	F86
	2.4 (8E2,B6)	AMM	120/163	09.2001	09.2004	RFC 62 LZ2	A150		1,0	F86
	2.4 (8E2,B6)	BDV	125/170	09.2001	09.2004	RFC 62 LZ2	A150		1,0	F86
	2.4 Cabriolet	AMM	120/163	04.2002	12.2005	RFC 62 LZ2	A150		1,0	F86
	2.4 Cabriolet	BDV	125/170	04.2002	12.2005	RFC 62 LZ2	A150		1,0	F86
	2.4 quattro (8D2,B5)	AGA- ALF- AML- APS - ARJ	121/165	03.1997	11.2000	RFC 62 LZ2	A150		1,0	F86
	2.4 quattro (8D2,B5)	APZ	120/163	08.1997	11.2000	RFC 62 LZ2	A150		1,0	F86
	2.4 i V6 30V, Quattro	AGA - AJG - AJG - AML - APS - ARJ [DOHC]	121/165	03.1997	07.1998	RFC 62 LZ2	A150		1,0	F86
	2.4 i V6 30V, Quattro	ALF [DOHC]	120-121/163-164	08.1997	07.1998	RFC 62 LZ2	A150		1,0	F86
	2.4 i V6 30V, Quattro	APZ [DOHC]	120/163	08.1998		RFC 62 LZ2	A150		1,0	F86
	2.4 i V6 30V Pack Clim	AFM	110/150	07.1995		RFC 58 LZ3EX	A58	B55	0,9	F54
	2.6 i V6, Quattro	ABC	110/150	01.1995	11.2000	RFC 58 LZ3EX	A58	B55	0,9	F54
	2.6 i V6 Quattro	ACZ	102/139	01.1995		RFC 58 LZ3EX	A58	B55	0,9	F54
	2.6, quattro	ABC	110/150	01.1996	09.2001	RFC 58 LZ3EX	A58	B55	0,9	F54
	2.8 (8D2,B5)	ACK- AHA - ALG - AMX - APR - AQD	142/193	10.1996	11.2000	RFC 62 LZ2	A150		1,0	F86
	2.8 quattro (8D2,B5)	ACK- AHA - ALG - AMX - APR - AQD	142/193	10.1996	10.2001	RFC 62 LZ2	A150		1,0	F86
	2.8 i V6, Quattro	AFC	120-128/163-174	01.1995		RFC 58 LZ3EX	A58	B55	0,9	F54
	2.8 i V6, Quattro	AAH	128/174	09.1995	07.1997	RFC 58 LZ3EX	A58	B55	0,9	F54
	2.8 i V6 30V, Quattro	ALG [DOHC]	142/193	08.1997	11.2000	RFC 62 LZ2	A150		1,0	F86
	2.8 i V6 30V, Quattro	AMX - APR - AQD [DOHC]	142/193	08.1998		RFC 62 LZ2	A150		1,0	F86
	2.8 i V6 30V, Quattro	ACK	142/193	10.1996	07.1998	RFC 62 LZ2	A150		1,0	F86
	2.8, Avant quattro	AAH	128/174	01.1996	09.1996	RFC 58 LZ3EX	A58	B55	1,0	F54
	2.8, quattro	AAH	128/174	01.1995	07.1997	RFC 58 LZ3EX	A58	B55	0,9	F54
	2.8, Avant quattro	ATX	140/190	03.1999	09.2000	RFC 62 LZ2	A150		1,0	F86
	3.0 Cabriolet	BBJ	160/218	04.2002	12.2005	RFC 62 LZ2	A150		1,0	F86
	3.0 quattro Cabriolet	ASN	162/220	05.2003	12.2005	RFC 62 LZ2	A150		1,0	F86
	3.0, quattro (8E2, B6)	BBJ	160/218	04.2001	12.2004	RFC 62 LZ2	A150		1,0	F86
	3.0, quattro (8EC, B7)	BBJ	160/218	11.2004	05.2008	RFC 62 LZ2	A150		1,0	F86
	3.0 (8E2, B6)	ASN	162/220	11.2000	12.2004	RFC 62 LZ2	A150		1,0	F86
	3.0 Avant (8E5,B6)	ASN	162/220	09.2001	12.2004	RFC 62 LZ2	A150		1,0	F86
	3.0 Cabriolet (8H7,B6, 8HE,B7)	ASN	162/220	09.2001	12.2004	RFC 62 LZ2	A150		1,0	F86
	3.0 Cabriolet quattro (8H7,B6, 8HE,B7)	ASN	162/220	05.2003	12.2005	RFC 62 LZ2	A150		1,0	F86
	4.2 S4 Avant quattro	BBK	253/344	03.2003	06.2008	RFC 52 LZ4E	A159		1,6	
	4.2 S4 quattro	BBK	253/344	03.2003	06.2008	RFC 52 LZ4E	A159		1,6	
	4.2 S4 quattro, Cabriolet	BBK	253/344	03.2004	06.2008	RFC 52 LZ4E	A159		1,6	
	RS4 quattro	BNS	309/420	09.2005	06.2008	FN 68 LZDPR	A523		0,7	
	RS4 quattro Avant	CFSA	331/450	05.2012		FN 68 LZDPR	A523		0,7	
	S4 quattro	AGB/AZB	195/265	09.1997	09.2001	FN 58 LZDPR	A198		0,75	
	S4 quattro	CAKA, CCBA	245/333	11.2008		FN 68 LZDPR	A523		0,7	
	S4 quattro Cabriolet	BBK	253/344	03.2004	03.2009	RFC 52 LZ4E	A159		1,6	
	RS4 quattro Cabriolet	BNS	309/420	06.2006	03.2009	FN 68 LZDPR	A523		0,7	
A4 (8K2, B8)	NEW 1.8 TFSI, quattro	CJEB	125/170	11.2011	12.2015	FN 72 HZIPRSO	A537		0,75	
	NEW 2.0 TFSI, quattro	CNCD	165/224	05.2013	12.2015	FN 72 HZIPRSO	A537		0,75	
A4 (8W2, B9)	NEW 1.4 TFSI	CVNA	110/150	08.2015		ZN 62 LSDPFRSO	A538		0,75	
	NEW 2.0 TFSI	CVKB	140/190	05.2015		FN 72 HZIPRSO	A537		0,75	
	NEW 2.0 TFSI, quattro	CYRC	183/249	11.2015		FN 72 HZIPRSO	A537		0,75	
	NEW 2.0 TFSI	CYRB	185/252	05.2015		FN 72 HZIPRSO	A537		0,75	

(f) Available until end of stock

(a) 30 000 km

(b) 60 000 km

(c) Grey sticker on ignition coil

(d) Green sticker on ignition coil

(e) Hex 21 mm

(f) Hex 16 mm

(g) Recommended for cold weather



EYQUEM



Box
10

Blister
4



F3

AUDI											
	NEW	2.0 TFSI quattro	CYRB	185/252	10.2015		FN 72 HZIPRSO	A537	0,75		
A4 Allroad (8KH, B8)	NEW	2.0 TFSI quattro	CNCD	165/224	05.2013	05.2016	FN 72 HZIPRSO	A537	0,75		
A4 Allroad (8WH, B9)	NEW	2.0 TFSI quattro	CYRC	183/249	05.2016		FN 72 HZIPRSO	A537	0,75		
	NEW	2.0 TFSI quattro	CYRB	185/252	01.2016		FN 72 HZIPRSO	A537	0,75		
A4 Avant (8K5, B8)	NEW	1.8 TFSI, quattro	CJEB	125/170	11.2011	12.2015	FN 72 HZIPRSO	A537	0,75		
	NEW	2.0 TFSI, quattro	CNCD	165/224	05.2013	12.2015	FN 72 HZIPRSO	A537	0,75		
A4 Avant (8W5, B9)	NEW	1.4 TFSI	CVNA	110/150	02.2016		ZN 62 LSDPFRSO	A538	0,75		
	NEW	2.0 TFSI	CVKB	140/190	08.2015		FN 72 HZIPRSO	A537	0,75		
	NEW	2.0 TFSI	CYRC	183/249	05.2016		FN 72 HZIPRSO	A537	0,75		
	NEW	2.0 TFSI	CYRB	185/252	05.2016		FN 72 HZIPRSO	A537	0,75		
	NEW	2.0 TFSI quattro	CYRC	183/249	11.2015		FN 72 HZIPRSO	A537	0,75		
	NEW	2.0 TFSI quattro	CYRB	185/252	08.2015		FN 72 HZIPRSO	A537	0,75		
A5 (8T3)		1.8 TFSI	CDHB	118/160	05.2009		FN 68 LZDPR	A523	0,7		
		1.8 TFSI	CABD	125/170	10.2007	11.2008	FN 68 LZDPR	A523	0,7		
	NEW	1.8 TFSI	CJEB	125/170	08.2011		FN 72 HZIPRSO	A537	0,75		
	NEW	1.8 TFSI	CJEE	130/177	05.2015	01.2017	FN 72 HZIPRSO	A537	0,75		
		2.0 TFSI	CDNB	132/180	11.2008		FN 68 LZDPR	A523	0,7		
		2.0 TFSI	CDNC	155/211	06.2008		FN 68 LZDPR	A523	0,7		
		2.0 TFSI quattro	CAEB/CDNC	155/211	06.2008		FN 68 LZDPR	A523	0,7		
		2.0 TFSI quattro	CAED, CPMB	162/220	03.2012		FN 68 LZDPR	A523	0,7		
	NEW	2.0 TFSI, quattro	CNCD	165/224	05.2013	05.2016	FN 72 HZIPRSO	A537	0,75		
	NEW	2.0 TFSI, quattro	CNCE	169/230	08.2015	01.2017	FN 72 HZIPRSO	A537	0,75		
		3.0 TFSI quattro	CMUA	200/272	12.2011		FN 68 LZDPR	A523	0,7		
		S5 quattro	CAKA, CGWC, CGXC, CREC, CTDA	245/333	10.2011		FN 68 LZDPR	A523	0,7		
		RS5 quattro	CFSA	331/450	03.2010		FN 68 LZDPR	A523	0,7		
A5 Cabriolet (8F7)		1.8 TFSI	CDHB	118/160	09.2009		FN 68 LZDPR	A523	0,7		
		1.8 TFSI	CABD	125/170	10.2011		FN 68 LZDPR	A523	0,7		
	NEW	1.8 TFSI	CJEB	125/170	10.2011		FN 72 HZIPRSO	A537	0,75		
	NEW	1.8 TFSI	CJEE	130/177	05.2015		FN 72 HZIPRSO	A537	0,75		
		2.0 TFSI	CDNB/CAEA	132/180	03.2009		FN 68 LZDPR	A523	0,7		
		2.0 TFSI	CDNC/CAEB	155/211	03.2009		FN 68 LZDPR	A523	0,7		
		2.0 TFSI quattro	CAEB/CDNC	155/211	03.2009		FN 68 LZDPR	A523	0,7		
		2.0 TFSI	CAED	162/220	05.2013		FN 68 LZDPR	A523	0,7		
		2.0 TFSI quattro	CPMB	162/220	03.2012		FN 68 LZDPR	A523	0,7		
	NEW	2.0 TFSI quattro	CNCD	165/224	05.2013		FN 72 HZIPRSO	A537	0,75		
	NEW	2.0 TFSI, quattro	CNCE	169/230	08.2015		FN 72 HZIPRSO	A537	0,75		
		3.0 TFSI quattro	CMUA	200/272	11.2011		FN 68 LZDPR	A523	0,7		
		RS 5 quattro	CFSA	331/450	02.2013		FN 68 LZDPR	A523	0,7		
A5 Sportback (8TA)	NEW	1.8 TFSI	CJED	106/144	09.2014		FN 72 HZIPRSO	A537	0,75		
		1.8 TFSI	CDHB	118/160	11.2009		FN 68 LZDPR	A523	0,7		
	NEW	1.8 TFSI	CJEB	125/170	08.2011		FN 72 HZIPRSO	A537	0,75		
	NEW	1.8 TFSI	CJEE	130/177	05.2015		FN 72 HZIPRSO	A537	0,75		
		2.0 TFSI	CDNB	132/180	09.2009		FN 68 LZDPR	A523	0,7		
		2.0 TFSI quattro	CDNC	155/211	09.2009		FN 68 LZDPR	A523	0,7		
	NEW	2.0 TFSI quattro	CNCD	165/224	05.2013		FN 72 HZIPRSO	A537	0,75		
	NEW	2.0 TFSI, quattro	CNCE	169/230	08.2015		FN 72 HZIPRSO	A537	0,75		
		3.0 TFSI quattro	CMUA	200/272	12.2011		FN 68 LZDPR	A523	0,7		
		S5 quattro	CAKA	245/333	01.2010	03.2012	FN 68 LZDPR	A523	0,7		
A6		1.6 i	ABB	75/102	06.1994	03.1997	RC 58 LZ3EX	A34	B54	0,9	L65
		1.8 i	AJP	92/125	06.1997		RFC 58 LZ3EX	A58	B55	0,9	F54
		1.8 i	ARH	92/125	07.1997	01.2005	RFC 58 LZ3EX	A58	B55	0,9	F54
		1.8 i	AQE	92/125	11.1998		RFC 58 LZ3EX	A58	B55	0,9	F54
		1.8, quattro	ADR	92/125	12.1995	02.1997	RFC 58 LZ3EX	A58	B55	0,9	F54
		1.8 i 20V	AFY	88/120	02.1998		RFC 58 LZ3EX	A58	B55	0,9	F54
		1.8 i 20V, quattro	AFY	88/120	05.1997		RFC 58 LZ3EX	A58	B55	0,9	F54
		1.8 T 20V, quattro	AEB [DOHC]	110/150	01.1997	01.1999	RFC 58 LZ3EX	A58	B55	0,9	F54
		1.8 T 20V, quattro	AWT	110/150	01.1997		RFC 58 LZ3EX	A58	B55	0,9	F54
		1.8 T 20V, quattro	ANB - ARK	110/150	01.1999		RFC 58 LZ3EX	A58	B55	0,9	F54
		1.8 T 20V, quattro	APU	110/150	11.1998		RFC 58 LZ3EX	A58	B55	0,9	F54
		2.0 i	ADW	79/107	06.1994	03.1997	RC 58 LZ3EX	A34	B54	0,9	L65



(1) Available until end of stock

- (a) 30 000 km
- (b) 60 000 km
- (c) Grey sticker on ignition coil
- (d) Green sticker on ignition coil

- (e) Hex 21 mm
- (f) Hex 16 mm
- (g) Recommended for cold weather



KW/HP



Box
10

Blister
4



F3-D1

AUDI

	2.4 iV6	ARN	100/136	01.1999		RFC 58 LZ3EX	A58	B55	0,9	F54
	2.4 iV6 30V	AFM	110/150	07.1995		RFC 58 LZ3EX	A58	B55	0,9	F54
	2.4 iV6 30V, quattro	AGA - AJG - ALF [DOHC]	120-121/163-164	01.1997	01.1999	RFC 58 LZP4	A193		1,5	
	2.6	ACZ	102/139	06.1994	02.1997	RFC 58 LZ3EX	A58	B55	0,9	F54
	2.6 Avant	ACZ	102/139	06.1994	02.1997	RFC 58 LZ3EX	A58	B55	1,0	F54
	2.6 iV6	ACZ	102-106/139-144	06.1994	02.1997	RFC 58 LZ3EX	A58	B55	0,9	F54
	2.6, quattro	ABC	110/150	06.1994	02.1997	RFC 58 LZ3EX	A58	B55	0,9	F54
	2.8 iV6, quattro	AEJ	120/163	08.1994	02.1997	RFC 42 LS	A25		0,8	F54
	2.8 iV6 30V	ATX [DOHC]	140/190	07.1999		RFC 58 LZP4	A193		1,5	
	2.8 iV6 30V, quattro	ALG [DOHC]	142/193	02.1997	01.1999	RFC 58 LZP4	A193		1,5	
	2.8 iV6 30V, Quattro	AMX [DOHC]	142/193	02.1997		RFC 58 LZP4	A193		1,5	
	2.8 (4B2, C5), Quattro	ACK- AHA - ALG - AMX - APR - AQD	142/193	02.1997	01.2005	RFC 62 LZ2	A150		1,0	F86
	2.8 iV6 30V, Quattro	AGE [DOHC]	132/180	10.1997	07.1998	RFC 58 LZP4	A193		1,5	
	2.8 iV6 30V, Quattro	APR - AQD [DOHC]	142/193	11.1998		RFC 58 LZP4	A193		1,5	
	2.8 iV6 30V, Quattro	ACK	142/193	12.1995	02.1997	RFC 58 LZP4	A193		1,5	
	2.8 iV6 Quattro	AFC	120-128/163-174	07.1994		RFC 58 LZ3EX	A58	B55	0,9	F54
	2.8, Avant quattro	AAH	128/174	06.1994	12.1997	RFC 58 LZ3EX	A58	B55	0,9	F54
	2.8, quattro	AAH	128/174	06.1994	02.1997	RFC 58 LZ3EX	A58	B55	0,9	F54
	4.2 quattro	ARS/ASG/AWN	220/300	11.1998		RFC 58 LZP4	A193		1,5	
A6 (4A,C4)	1.8, quattro	ADR	92/125	12.1995	10.1997	RFC 58 LZ3EX	A58	B55	0,9	F54
	2.0	AAE	74/101	06.1994	10.1997	RC 58 LZ3EX	A34	B54	0,9	L65
	2.0	ABK	85/115	06.1994	10.1997	RC 58 LZ3EX	A34	B54	0,9	L65
	2.0 16V, quattro	ACE	103/140	06.1994	10.1997	RFC 62 LZ3EX	A86		0,9	F86
	2.3, quattro	AAR	98/133	06.1994	12.1995	RC 52 LZ3EX	A35		0,9	L65
	2.6, quattro	ABC	110/150	06.1994	10.1997	RFC 58 LZ3EX	A58	B55	0,9	F54
	2.8, quattro	AAH/AEJ/AFC	128/174	06.1994	10.1997	RFC 58 LZ3EX	A58	B55	0,9	F54
	2.8, quattro	ACK	142/193	12.1995	10.1997	RFC 62 LZ2	A150		1,0	F86
	S6 4.2 quattro	AEC	213/290	06.1994	10.1997	RC 52 LJS4E	A155		1,6	
A6 (4B2,C5)	1.8	AFY	85/115	05.1997	01.2005	RFC 58 LZ3EX	A58	B55	0,9	F54
	1.8	AJP/AQE/ARH	92/125	07.1997	01.2005	RFC 58 LZ3EX	A58	B55	0,9	F54
	1.8 T, quattro	ARK/AEB/ANB/APU/AWT/AWL	110/150	01.1997	01.2005	FN 58 LZDPR	A198		0,75	
	1.8 T 20V, quattro	AJL	132/180	12.1997	01.2005	FN 58 LZDPR	A198		0,75	
	2.4 iV6	ALW	100/136	08.1997	01.1999	RFC 58 LZ3EX	A58	B55	0,9	F54
	2.4 iV6	ALW	100/136	07.1998	01.2005	RFC 62 LZ2	A150		1,0	F86
	2.4 iV6 30V	APC	115/156	02.1997	01.2005	RFC 62 LZ2	A150		1,0	F86
	2.4, quattro	APC	115/156	08.1998	07.1999	RFC 62 LZ2	A150		1,0	F86
	2.4	APC	115/156	02.1997	01.2005	RFC 62 LZ2	A150		1,0	F86
	2.4, quattro	AJG- APZ-AMM	120/163	02.1997	01.2005	RFC 62 LZ2	A150		1,0	F86
	2.4, quattro	AGA- ALF- AML- APS - ARJ	121/165	02.1997	01.2005	RFC 62 LZ2	A150		1,0	F86
	2.4, quattro	BDV	125/170	08.2001	01.2005	RFC 62 LZ2	A150		1,0	F86
	2.7 T	AJK	169/230	02.1999	01.2005	FN 58 LZDPR	A198		0,75	
	2.7 T, quattro	AZA	169/230	12.1997	01.2005	FN 58 LZDPR	A198		0,75	
	2.7 T, quattro	BES/ARE	184/250	08.2001	01.2005	FN 58 LZDPR	A198		0,75	
	2.8, quattro	AGE	132/180	10.1997	05.2000	RFC 62 LZ2	A150		1,0	F86
	2.8, quattro	ATX	140/190	07.1999	01.2005	RFC 62 LZ2	A150		1,0	F86
	2.8, quattro	ACK- AHA - ALG - AMX - APR - AQD	142/193	02.1997	01.2005	RFC 62 LZ2	A150		1,0	F86
	3.0	ASN	162/220	08.2001	01.2005	RFC 62 LZ2	A150		1,0	F86
	3.0, quattro	BBJ	160/218	06.2001	07.2004	RFC 62 LZ2	A150		1,0	F86
	3.7 iV8 40V, quattro	AQG	191/260	03.1999	01.2005	RFC 58 LZP4	A193		1,5	
	4.2 quattro	ARS/ASG	220/300	11.1998	01.2005	RFC 52 LZ4E	A159		1,6	
A6 Avant (4A,C4)	1.8 i 20V, quattro	ADR	92/125	12.1995	12.1997	RFC 58 LZ3EX	A58	B55	0,9	F54
	2.0 i	AAE,ABK	74-85/101-115	06.1994	02.1997	RC 58 LZ3EX	A34	B54	0,9	L65
	2.0 i 16V, quattro	ACE	103/140	06.1994	02.1997	RFC 62 LZ3EX	A86		0,9	F86
	2.3 i, quattro	AAR	98/133	06.1994	02.1997	RC 52 LZ3EX	A35		0,9	L65
	2.6 iV6, quattro	ABC	110/150	06.1994	02.1997	RFC 58 LZ3EX	A58	B55	0,9	F54
	2.8 iV6, quattro	AAH	128/174	06.1994	02.1997	RFC 58 LZ3EX	A58	B55	0,9	F54
	2.8, quattro	ACK	142/193	12.1995	12.1997	RFC 62 LZ2	A150		1,0	F86
	4.2 iV8 32V S6 quattro	AEC [DOHC]	213/290	06.1994	02.1997	RC 52 LJS4E	A155		1,6	
A6 Avant (4B5,C5)	1.8	AFY	85/115	02.1998	01.2005	RFC 58 LZ3EX	A58	B55	1,0	F54
	1.8	AJP/AQE/ARH	92/125	12.1997	01.2005	RFC 58 LZ3EX	A58	B55	1,0	F54
	1.8 T, quattro	ARK/AEB/ANB/APU/AWT	110/150	02.1997	01.2005	FN 58 LZDPR	A198		0,75	
	1.8 T, quattro	AJL	132/180	04.1999	01.2005	FN 58 LZDPR	A198		0,75	

(1) Available until end of stock

(a) 30 000 km

(b) 60 000 km

(c) Grey sticker on ignition coil

(d) Green sticker on ignition coil

(e) Hex 21 mm

(f) Hex 16 mm

(g) Recommended for cold weather



EYQUEM



Box
10

Blister
4



F3 → 1

AUDI									
	2.4	ALW/ARN/ASM	100/136	07.1998	01.2005	RFC 62 LZ2	A150	1,0	F86
	2.4, quattro	APC	115/156	12.1997	01.2005	RFC 62 LZ2	A150	1,0	F86
	2.4 i V6 30V, quattro	AJG/AMM/APZ	120/163	12.1997	01.2005	RFC 62 LZ2	A150	1,0	F86
	2.4 i V6 30V, quattro	AGA/ALF/AML/APS - ARJ [DOHC]	121/165	12.1997	01.2005	RFC 62 LZ2	A150	1,0	F86
	2.4, quattro	BDV	125/170	08.2001	01.2005	RFC 62 LZ2	A150	1,0	F86
	2.7 T, quattro	AJK	169/230	02.1999	01.2005	FN 58 LZDPR	A198	0,75	
	2.7 T, quattro	ARE/BES	184/250	08.2001	01.2005	FN 58 LZDPR	A198	0,75	
	2.8, quattro	AGE	132/180	12.1997	05.2000	RFC 62 LZ2	A150	1,0	F86
	2.8	ATX	140/190	07.1999	01.2005	RFC 62 LZ2	A150	1,0	F86
	2.8, quattro	ACK- AHA - ALG - AMX - APR - AQD	142/193	12.1997	01.2005	RFC 62 LZ2	A150	1,0	F86
	3.0, quattro	ASN	162/220	08.2001	01.2005	RFC 62 LZ2	A150	1,0	F86
	3.7, quattro	AQG	191/260	03.1999	01.2005	RFC 58 LZP4	A193	1,5	
	4.2, quattro	ARS/ASG/AWN	220/300	11.1998	01.2005	RFC 52 LZ4E	A159	1,6	
A6 Avant (4F5,C6)	2.0 TFSI	BPJ	125/170	06.2005	03.2011	FN 68 LZDPR	A523	0,7	
	3.0, quattro	BBJ	160/218	03.2005	05.2006	RFC 62 LZ2	A150	1,0	F86
	3.0 TFSI quattro	CAJA	213/290	10.2008	03.2011	FN 68 LZDPR	A523	0,7	
	3.0 TFSI quattro	CCAA	220/300	10.2008	03.2011	FN 68 LZDPR	A523	0,7	
	4.2, quattro	BAT	246/335	03.2005	05.2006	RFC 52 LZ4E	A159	1,6	
A6 Avant (4G5,C7,4GD)	1.8 TFSI	CYGA	140/190	09.2014		FN 72 HZIPRSO	A537	0,75	
	2.0 TFSI	CDNB	132/180	06.2011		FN 68 LZDPR	A523	0,7	
	2.0 TFSI	CYPA	185/252	09.2014		FN 72 HZIPRSO	A537	0,75	
	2.0 TFSI quattro	CYPB	183/249	05.2015		FN 72 HZIPRSO	A537	0,75	
	3.0 TFSI quattro	CGWB	220/300	05.2011	05.2012	FN 68 LZDPR	A523	0,7	
A6	1.8 T 20V, quattro	AJL	132/180	12.1997	01.2005	FN 58 LZDPR	A198	0,75	
A6 (4F2,C6)	2.0 TFSI	BPJ	125/170	06.2005	03.2011	FN 68 LZDPR	A523	0,7	
	3.0, quattro	BBJ	160/218	05.2004	05.2006	RFC 62 LZ2	A150	1,0	F86
	3.0 TFSI quattro	CAJA	213/290	10.2008	03.2011	FN 68 LZDPR	A523	0,7	
	3.0 TFSI quattro	CCAA	220/300	10.2008	03.2011	FN 68 LZDPR	A523	0,7	
	4.2 quattro	BAT	246/335	05.2004	05.2006	RFC 52 LZ4E	A159	1,6	
A6 (4G2,C7,4GC)	1.8 TFSI	CYGA	140/190	09.2014		FN 72 HZIPRSO	A537	0,75	
	2.0 TFSI	CDNB	132/180	05.2011		FN 68 LZDPR	A523	0,7	
	2.0 TFSI, quattro	CAEB	155/211	03.2011	05.2013	FN 68 LZDPR	A523	0,7	
	2.0 TFSI hybrid	CHJA	155/211	11.2011		FN 68 LZDPR	A523	0,7	
	2.0 TFSI, quattro	CAED	162/220	05.2013		FN 68 LZDPR	A523	0,7	
	2.0 TFSI quattro	CYPB	183/249	05.2015		FN 72 HZIPRSO	A537	0,75	
	2.0 TFSI, quattro	CYPA	185/252	09.2014		FN 72 HZIPRSO	A537	0,75	
	3.0 TFSI quattro	CGWB	220/300	11.2010	05.2012	FN 68 LZDPR	A523	0,7	
A6 Allroad (4FH,C6)	3.0 TFSI quattro	CAJA	213/290	10.2008	08.2011	FN 68 LZDPR	A523	0,7	
A6 Allroad (4GH, 4GJ)	3.0 TFSI quattro	CGWD	228/310	01.2012		FN 68 LZDPR	A523	0,7	
A7 Sportback (4GA,4GF)	1.8 TFSI	CYGA	140/190	04.2015		FN 72 HZIPRSO	A537	0,75	
	2.0 TFSI	CYPA	185/252	09.2014		FN 72 HZIPRSO	A537	0,75	
	2.0 TFSI quattro	CYPB	183/249	05.2015		FN 72 HZIPRSO	A537	0,75	
	2.0 TFSI quattro	CYPA	185/252	05.2015		FN 72 HZIPRSO	A537	0,75	
	3.0 TFSI	CGWB/CHMA	220/300	10.2010		FN 68 LZDPR	A523	0,7	
	3.0 TFSI quattro	CGWD/CGXB/CTTA/CTUA	228/310	01.2011		FN 68 LZDPR	A523	0,7	
A8	3.7 i V8 32V	AKJ [DOHC]	169/230	07.1995	10.1998	RC 52 LJS4E	A155	1,6	
	4.2 i V8, Quattro	AKG	220/300	04.1997	09.1998	RC 52 LJS4E	A155	1,6	
	4.2 i V8 32V	AGH	210/286	03.1995		RC 52 LJS4E	A155	1,6	
	4.2 i V8 32V, Quattro	ABZ	220/300	03.1994	07.1996	RC 52 LJS4E	A155	1,6	
A8 (4D2,4D8)	2.8 i V6, quattro	AEJ	120/163	07.1995	03.1996	RFC 42 LS	A25	0,8	F54
	2.8 i V6, quattro	AAH	128/174	03.1994	03.1996	RFC 58 LZ3EX	A58	0,9	F54
	2.8 i V6 30V	ALG/ACK/AMX/APR/AQD	142/193	04.1996	09.2002	RFC 62 LZ2	A150	1,0	F86
	3.7 i V8 32V, quattro	AEW	169/230	07.1995	12.1998	RC 52 LJS4E	A155	1,6	
	3.7 i V8 40V, quattro	AKC/AQG	191/260	11.1998	09.2002	RFC 58 LZP4	A193	1,5	
	4.2 i V8, quattro	ARU [DOHC]	175/238	02.1999	04.2000	RFC 52 LZ4E	A159	1,6	
	4.2 i V8 32V quattro	AEM	180/245	03.1994	07.1996	RC 52 LJS4E	A155	1,6	
	4.2 i V8 quattro	ABZ/AKG	220/300	04.1997	09.1998	RC 52 LJS4E	A155	1,6	
	4.2 i V8 40V quattro	AQF/AUW/AUX	228/310	11.1998	09.2002	RFC 52 LZ4E	A159	1,6	
	6.0 W12 quattro	AZC	309/420	01.2001	09.2002	RFN 52 LZDPF5	A153	1,0	
A8 (4E)	3.0	BBJ	160/218	07.2003	05.2006	RFC 62 LZ2	A150	1,0	F86

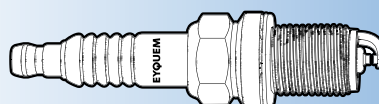

(1) Available until end of stock

- (a) 30 000 km
- (b) 60 000 km
- (c) Grey sticker on ignition coil
- (d) Green sticker on ignition coil

- (e) Hex 21 mm
- (f) Hex 16 mm
- (g) Recommended for cold weather



KW/HP



Box
10

Blister
4



F3-1

AUDI

	3.0	ASN	162/220	07.2003	05.2006	RFC 62 LZ2	A150		1,0	F86
	3.7 quattro	BFL	206/280	10.2002	05.2006	RFC 52 LZ4E	A159		1,6	
	4.2 quattro	BFM	246/335	10.2002	07.2010	RFC 52 LZ4E	A159		1,6	
	6.0 W12 quattro	BHT	331/450	12.2003	07.2010	RFN 52 LZDPF5	A153		1,0	
A8 (4H)	2.0 TFSI hybrid	CHJA	155/211	02.2012		FN 68 LZDPR	A523		0,7	
	3.0 TFSI quattro	CGWA/CGXA	213/290	07.2010		FN 68 LZDPR	A523		0,7	
	3.0 TFSI quattro	CGWD	228/310	11.2011		FN 68 LZDPR	A523		0,7	
	3.0 TFSI quattro	CGXC/CMDA/CREC/ CTDA/CTUB	245/333	06.2010		FN 68 LZDPR	A523		0,7	
ALLROAD (4BH,C5)	2.7 T quattro	BES/ARE	184/250	05.2000	08.2005	FN 58 LZDPR	A198		0,75	
	4.2 V8 quattro	BAS	220/300	07.2002	08.2005	RFC 52 LZ4E	A159		1,6	
CABRIOLET (8G7, B4)	1.6 i	ADP	74/101	01.1997	08.2000	RFC 58 LZ3EX	A58	B55	0,9	F54
	1.8	ADR	92/125	01.1997	08.2000	RFC 58 LZ3EX	A58	B55	0,9	F54
	2.0 i E	ABK	85/115	01.1993	07.1998	RC 58 LZ3EX	A34	B54	0,9	L65
	2.0 i 16V	ACE	103/140	05.1995	07.1996	RFC 62 LZ3EX	A86		0,9	F86
	2.3 E	NG	98/133	05.1991	07.1994	RC 52 LZ3EX	A35		0,9	L65
	2.3 i	NG Cat	98-100/133-136	05.1991	07.1994	RC 52 LZ3EX	A35		0,9	L65
	2.6	ACZ	102/138	05.1995	08.2000	RFC 58 LZ3EX	A58	B55	0,9	F54
	2.6	ABC	110/150	06.1993	08.2000	RFC 58 LZ3EX	A58	B55	0,9	F54
	2.6 i V6	ACZ - ABC	102-110/139-150	01.1994	08.2000	RFC 58 LZ3EX	A58	B55	0,9	F54
	2.8 i V6	AAH - AFC	128/174	11.1992	08.2000	RFC 58 LZ3EX	A58	B55	0,9	F54
COUPE	1.6	YN	55/75	09.1975	08.1981	C 62 LS	A4	B5	0,7	L65
	1.8	DD	55/75	08.1981	08.1982	C 62 LS	A4	B5	0,7	L65
	1.8 i GT, quattro	SF - PV	65-81/88-110	09.1982	03.1986	C 62 LS3X	A13	B15	0,8	L65
	1.8 GT	SF - PV	65/88	04.1986	10.1988	RC 58 LZ3EX	A34	B54	0,9	L65
	1.8 i S, GT, quattro	DZ	82/112	01.1985	07.1991	C 62 LS3X	A13	B15	0,8	L65
	1.8 Quattro	DS - JV	66/90	09.1982	10.1988	C 62 LS3X	A13	B15	0,8	L65
	1.8 S, GT, quattro	JN	66/90	01.1985	07.1988	RC 58 LZ3EX	A34	B54	0,9	L65
	1.8 GT	PV	79/107	08.1986	10.1987	C 62 LS3X	A13	B15	0,8	L65
	1.9 5S	WN	85/115	08.1980	08.1983	C 82 LS	A40	B6	0,7	L87
	2.0 5E	JL - HP	81-85/110-115	08.1983	10.1988	C 62 LS3X	A13	B15	0,8	L65
	2.0 i	3A - AAD	83-85/113-115	05.1989	07.1991	RC 58 LZ3EX	A34	B54	0,9	L65
	2.0 i 16V	ACE	103/140	01.1992	12.1995	RFC 62 LZ3EX	A86		0,9	F86
	2.0 i 16V	6A	103/140	03.1990	07.1992	RFC 62 LZ3EX	A86		0,9	F86
	2.0 i 20V quattro	NM	118/160	11.1988	07.1991	FC 62 LS3X	A57		0,9	F86
	2.0 i 5E	SK - JS	83-85/113-115	08.1983	10.1988	C 62 LS3X	A13	B15	0,8	L65
	2.1 i L5 5E	KE	96/131	09.1981	08.1984	C 72 LS3X	A63		0,8	L87
	2.2	KL	96/131	09.1981	08.1984	C 72 LS3X	A63		0,8	L87
	2.2 i L5	KX	85/115	01.1984	10.1988	C 62 LS3X	A13	B15	0,8	L65
	2.2 i L5 Quattro	KV	100/136	08.1984	10.1988	C 62 LS3X	A13	B15	0,8	L65
	2.2 i L5 Quattro	JT	88/120	08.1984	10.1988	C 62 LS3X	A13	B15	0,8	L65
	2.2 i L5 Quattro	HY	100/136	09.1984	10.1988	C 72 LS3X	A63		0,8	L87
	2.2 i L5 Quattro	KV	100/136	11.1988	07.1991	C 72 LS3X	A63		0,8	L87
	2.3	NG	100/136	10.1988	07.1993	RC 52 LZ3EX	A35		0,9	L65
	2.3 i, Quattro	NG	100/136	01.1986	10.1988	RC 52 LZ3EX	A35		0,9	L65
	2.3 i, Quattro	NG Cat	98-100/133-136	11.1988	12.1996	RC 52 LZ3EX	A35		0,9	L65
	2.3 i 20V, Quattro	7A	123-125/167-170	11.1988	09.1991	RFC 62 LZ3EX	A86		0,9	F86
	2.3 quattro	NG	100/136	11.1988	12.1992	RC 52 LZ3EX	A35		0,9	L65
	2.3, quattro	NG	100/136	01.1987	10.1988	RC 58 LZ3EX	A34	B54	0,9	L65
	2.3, quattro	NG	98/133	03.1990	07.1993	RC 52 LZ3EX	A35		0,9	L65
	2.6 i V6, Quattro	ABC	110/150	07.1992	12.1996	RFC 58 LZ3EX	A58	B55	0,9	F54
	2.8 i V6, Quattro	AAH	128/174	08.1991	12.1996	RFC 58 LZ3EX	A58	B55	0,9	F54
FOX	1.6	YK - YG - YH	60-61/81-83	09.1974	07.1980	C 62 LS	A4	B5	0,7	L65
QUATTRO	2.2 i Turbo	1B	147/200	08.1987	12.1990	C 62 LS3X	A13	B15	0,8	L65
	2.2 Turbo	MB	147/200	08.1987	07.1989	C 62 LS3X	A13	B15	0,8	L65
Q2 (GA)	NEW 1.4 TFSI	CZEA	110/150	06.2016		ZN 62 LSDPFRSO	A538		0,75	
Q3 (8U)	NEW 1.4 TFSI	CZDB	92/125	07.2016		ZN 62 LSDPFRSO	A538		0,75	
	NEW 1.4 TFSI	CHPB/CZEA/CZDA	110/150	10.2013		ZN 62 LSDPFRSO	A538		0,75	
	NEW 2.0 TFSI	CULB	132/180	05.2015		FN 72 HZIPRSO	A537		0,75	
	NEW 2.0 TFSI quattro	CULB	132/180	11.2014		FN 72 HZIPRSO	A537		0,75	
	NEW 2.0 TFSI quattro		162/220	11.2014		FN 72 HZIPRSO	A537		0,75	
	2.0 TFSI quattro	CCZC	125/170	06.2011		FN 68 LZDPR	A523		0,7	
	2.0 TFSI quattro	CPSA	155/211	06.2011		FN 68 LZDPR	A523		0,7	
Q5 (8R)	2.0 TFSI quattro	CDNB	132/180	08.2009	09.2012	FN 68 LZDPR	A523		0,7	
	NEW 2.0 TFSI quattro	CNCB	132/180	09.2014		FN 72 HZIPRSO	A537		0,75	

(1) Available until end of stock

(a) 30 000 km

(b) 60 000 km

(c) Grey sticker on ignition coil

(d) Green sticker on ignition coil

(e) Hex 21 mm

(f) Hex 16 mm

(g) Recommended for cold weather



EYQUEM



Box 10
Blister 4



F3 → 1

AUDI									
	2.0 TFSI quattro	CDNC	155/211	11.2008		FN 68 LZDPR	A523		0,7
	2.0 TFSI hybrid quattro	CHJA	155/211	06.2011		FN 68 LZDPR	A523		0,7
	2.0 TFSI quattro	CPMB	162/220	05.2013		FN 68 LZDPR	A523		0,7
	NEW 2.0 TFSI quattro	CNCD	165/224	06.2012		FN 72 HZIPRSO	A537		0,75
	NEW 2.0 TFSI quattro	CNCE	169/230	08.2015		FN 72 HZIPRSO	A537		0,75
	3.0 TFSI quattro	CTUC/CTVA	200/272	06.2012		FN 68 LZDPR	A523		0,7
Q7 (4L)	3.0 TFSI	CJTC	200/272	05.2010		FN 68 LZDPR	A523		0,7
	3.0 TFSI	CJWE	206/280	05.2011		FN 68 LZDPR	A523		0,7
	3.0 TFSI	CJTB	245/333	05.2010		FN 68 LZDPR	A523		0,7
Q7 (4M)	NEW 2.0 TFSI quattro	CYRB	185/252	08.2015		FN 72 HZIPRSO	A537		0,75
R8	5.2 FSI quattro	BUJ	386/525	09.2010		FN 68 LZDPR	A523		0,7
	5.2 FSI quattro	CTPA	404/549	05.2012		FN 68 LZDPR	A523		0,7
	5.2 FSI quattro	CMPA	412/560	11.2010		FN 68 LZDPR	A523		0,7
	5.2 FSI quattro	CTPB	419/570	07.2014	07.2015	FN 68 LZDPR	A523		0,7
R8 Spyder	5.2 FSI quattro	BUJ	386/525	09.2010	07.2015	FN 68 LZDPR	A523		0,7
	5.2 FSI quattro	CMPA	412/560	11.2011		FN 68 LZDPR	A523		0,7
TT Roadster (8J9)	1.8 TFSI	CDAА	118/160	06.2008	06.2014	FN 68 LZDPR	A523		0,7
	2.0 TFSI	BWA	147/200	03.2007	06.2010	FN 68 LZDPR	A523		0,7
	2.0 TFSI	CCZA	147/200	06.2008	06.2010	FN 68 LZDPR	A523		0,7
	2.0 TFSI, quattro	CESA/CETA	155/211	05.2010	06.2014	FN 68 LZDPR	A523		0,7
	2.0 TTS quattro	CDLA/CDMA	195/265	05.2008	06.2014	FN 68 LZDPR	A523		0,7
	2.0 TTS quattro	CDLB	200/272	05.2008	06.2014	FN 68 LZDPR	A523		0,7
TT Roadster (8N9)	1.8 T	AUM	110/150	10.2001	06.2006	FN 58 LZDPR	A198		0,75
	1.8 T	BVP	120/163	09.2005	06.2006	FN 58 LZDPR	A198		0,75
	1.8 T, quattro	AJQ/APP/ATC/AUQ	132/180	10.1999	06.2006	FN 58 LZDPR	A198		0,75
	1.8 T	AJQ/ARY/AUQ	140/190	02.2000	06.2006	FN 58 LZDPR	A198		0,75
	1.8 T quattro	BVR	140/190	09.2005	06.2006	FN 58 LZDPR	A198		0,75
	1.8 T quattro	APX/BAM	165/224	10.1999	06.2006	FN 58 LZDPR	A198		0,75
TT Roadster (FV9)	NEW 1.8 TFSI	CJSA/CJSB	132/180	08.2015		FN 72 HZIPRSO	A537		0,75
	NEW 2.0 TFSI, quattro	CHHC	169/230	11.2014		FN 72 HZIPRSO	A537		0,75
	NEW 2.0 TTS quattro	CJXF	210/286	02.2015		FN 72 HZIPRSO	A537		0,75
	NEW 2.0 TTS quattro	CJXG	228/310	11.2014		FN 72 HZIPRSO	A537		0,75
TT (8N3)	1.8 T	AUM	110/150	09.2002	06.2006	FN 58 LZDPR	A198		0,75
	1.8 T	BVP	120/163	09.2005	06.2006	FN 58 LZDPR	A198		0,75
	1.8 T, quattro	AWP/AJQ/APP/ARY/AUQ/ATC	132/180	10.1998	06.2006	FN 58 LZDPR	A198		0,75
	1.8 T, quattro	BVR	140/190	09.2005	06.2006	FN 58 LZDPR	A198		0,75
	1.8 T quattro	BAM/APX	165/224	10.1998	06.2006	FN 58 LZDPR	A198		0,75
	1.8 T quattro	BFV	176/239	03.2005	06.2006	FN 58 LZDPR	A198		0,75
TT II (8J3)	1.8 TFSI	CDAА	118/161	06.2008	06.2014	FN 68 LZDPR	A523		0,7
	2.0 TFSI	BPY/BWA/CCTA	147/200	08.2006	06.2010	FN 68 LZDPR	A523		0,7
	2.0 TFSI quattro	BWA/CCZA	147/200	08.2006	06.2010	FN 68 LZDPR	A523		0,7
	2.0 TFSI, quattro	CESA/CETA	155/211	05.2010	06.2014	FN 68 LZDPR	A523		0,7
	2.0 TTS quattro	CDLA/CDMA	195/265	05.2008	06.2014	FN 68 LZDPR	A523		0,7
	2.0 TFSI quattro	CDLB	200/272	05.2008	06.2014	FN 68 LZDPR	A523		0,7
TT (FV3)	NEW 1.8 TFSI	CJSA/CJSB	132/180	08.2015		FN 72 HZIPRSO	A537		0,75
	NEW 2.0 TFSI, quattro	CHHC	169/230	07.2014		FN 72 HZIPRSO	A537		0,75
	NEW 2.0 TTS quattro	CJXF	210/286	02.2015		FN 72 HZIPRSO	A537		0,75
	NEW 2.0 TTS quattro	CJXG	228/310	11.2014		FN 72 HZIPRSO	A537		0,75
V8	3.6 quattro	PT	180/245	04.1993	02.1994	RC 52 LJS4E	A155		1,6
	3.6 Quattro	PT	180-184/245-250	10.1988	06.1994	RC 52 LJS	A62	B27	0,8 J65
	3.6 quattro	PT	184/250	10.1988	02.1994	RC 52 LJS4E	A155		1,6
	4.2 i V8 32V Quattro	ABH	206/280	10.1991	02.1994	RC 52 LJS4E	A155		1,6

AUSTIN - MORRIS										
1100-1300	Tous modèles (all models)				12.1975	C 62 LS	A4	B5	0,7	L65
1800-2200	Tous modèles (all models)				12.1975	C 62 LS	A4	B5	0,7	L65
ITAL	1.3 1300					C 62 LS	A4	B5	0,7	L65
	1.7					C 52 LJS	A23		0,7	J65
	1.8 1800					C 62 LS	A4	B5	0,7	L65
ITAL VAN / PICK-UP					12.1983	C 62 LS	A4	B5	0,7	L65
MAESTRO (XC)	1.6 Mayfair HLS	16HC37	61/83	03.1983	08.1990	FN 52 LS	A41		0,8	F54

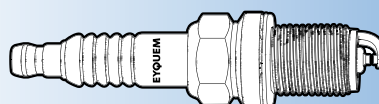

- (1) Available until end of stock
- (a) 30 000 km
- (b) 60 000 km
- (c) Grey sticker on ignition coil
- (d) Green sticker on ignition coil

- (e) Hex 21 mm
- (f) Hex 16 mm
- (g) Recommended for cold weather



Box
10

Blister
4



F3-1

AUSTIN - MORRIS

MAESTRO	2.0 EFI	20 HA50AA/20 HC51AA/ 20 HC81	83/113	10.1984	08.1990	RC 72 LS	A32	B26	0,8	L87
MARINA	1.3 1300					C 62 LS	A4	B5	0,7	L65
	1.7					C 52 LJS	A23		0,7	J65
	1.8 1800					C 62 LS	A4	B5	0,7	L65
	Van, Pick-Up				12.1983	C 62 LS	A4	B5	0,7	L65
MINI	Tous modèles (all models)			01.1959	12.1971	C 62 LS	A4	B5	0,7	L65
	Van, Pick-Up				12.1983	C 62 LS	A4	B5	0,7	L65
	1.0 90, 1.3 120, De Tomaso	BLMC 99 H		10.1972	12.1983	RC 62 LS	A6	B17	0,8	L65
MINOR	1.0					C 62 LS	A4	B5	0,7	L65
	1.1 Van, Pick-Up				12.1983	C 62 LS	A4	B5	0,7	L65
MONTEGO	1.6 LS, HL	16HC37	61/83	04.1984	08.1988	FN 52 LS	A41		0,8	F54
	2.0	20 H/20 HSC	74/101	04.1984	08.1988	RC 62 LS5	A24		1,1	L65-5
	2.0 HLI, Kombi	20 H	83/113	10.1984	08.1988	RC 72 LS	A32	B26	0,8	L87
	2.0 Mayfair	20 H(EFI)	83/113	04.1984	08.1988	RC 72 LS	A32	B26	0,8	L87

AUTOBIANCHI

A 112	0.9 E, Junior, LX	A 112...		03.1973	12.1986	RC 62 LS	A6	B17	0,7	L65
	1.0 Elegant, Elite	A 112 B1...	35-36/48-49	11.1977	02.1984	RC 62 LS	A6	B17	0,7	L65
	1.05 Abarth	A 112 A		08.1977	02.1984	RC 72 LS	A32	B26	0,7	L87
Y10	1.0 Fire, Fire 4x4	156.A2.000	33/45	03.1985	02.1989	RFC 52 LS	A3	B16	0,8	F54
	1.0 ie Fire	156.A2.256		01.1989	09.1992	RFN 58 LZ (b)	A7	B28	0,9	F54
	1.0 ie Fire	156.A2.256		01.1989	09.1992	RFN 58 LZ3A (g)	A515		0,9	
	1.0 ie Fire, Fire 4x4	156.A3.000	32-37/44-50	09.1986	12.1988	RFC 52 LS	A3	B16	0,8	F54
	1.0 ie Fire, Fire 4x4	156.A2.100	32/44	10.1987	09.1992	RFC 52 LS	A3	B16	0,8	F54
	1.0 ie Fire, Fire 4x4	156.A2.146	33/45	10.1987	07.1989	RFC 52 LS	A3	B16	0,8	F54
	1.05 Touring	156.A.000		03.1985	02.1989	RC 62 LS	A6	B17	0,7	L65
	1.05 Turbo	156.A1.000	63/86	03.1985	02.1989	RC 82 L	A94		0,7	
	1.1 i, ie Fire ie, Selectronic ie, 4x4 ie	176.B2.000	40/54	02.1995		RFN 58 LZ (b)	A7	B28	0,9	F54
	1.1 i, ie Fire ie, Selectronic ie, 4x4 ie	176.B2.000	40/54	02.1995		RFN 58 LZ3A (g)	A515		0,9	
	1.1 ie Fire 4x4 ie, Fire LX ie	156.C.000		01.1989	01.1995	RFC 52 LS	A3	B16	0,8	F54
	1.1 ie Fire ie, Selectronic ie, 4x4 ie	156.C.046 Cat	37/50	07.1989		RFN 58 LZ (b)	A7	B28	0,9	F54
	1.1 ie Fire ie, Selectronic ie, 4x4 ie	156.C.046 Cat	37/50	07.1989		RFN 58 LZ3A (g)	A515		0,9	
	1.3 ie GTie, Elite	146.A5.046 - 156.B.000	57/78	11.1987	01.1995	RC 62 LS	A6	B17	0,7	L65

BEDFORD

ASTRA	1.3	13 S [OHC]	55/75	01.1982	10.1989	RC 72 LS	A32	B26	0,7	L87
	1.4	14 NV [OHC]	55/75	09.1989	12.1994	RC 62 LS	A6	B17	0,7	L65
	1.6	16 SV [OHC]	60/82	01.1982	12.1994	RC 72 LS	A32	B26	0,7	L87
BEAGLE, HA VAN	1.3			01.1971	12.1983	RC 52 LS5	A36	B38	1,1	L65-5
BLITZ	2.0 230			01.1978	04.1984	RC 42 S	A69	B23	0,7	N43
	2.0 250			01.1978	04.1984	RC 42 S	A69	B23	0,7	N43
	2.0 280			01.1978	04.1984	RC 42 S	A69	B23	0,7	N43
	2.0 350			01.1978	04.1984	RC 42 S	A69	B23	0,7	N43
	2.3 CF 2			01.1984	12.1987	RC 52 LJS5	A74	B56	1,0	
BRAVA	2.3 4x4			12.1988	06.1994	RC 62 LS5	A24		1,1	L65-5
CHEVANNE	1.3			01.1976	12.1982	RC 52 LS5	A36	B38	1,1	L65-5
KB	1.6 25			01.1980	01.1988	RC 32 LS	A49	B19	0,8	L3
	1.6 4, 26, 41			01.1980	12.1988	RC 62 LS	A6	B17	0,8	L65
MIDI	1.8 2.0			02.1985		RC 62 LS	A6	B17	0,8	L65
RASCAL	1.0 99170, 99180			02.1986	06.1993	RC 62 LS	A6	B17	0,8	L65

BENTLEY

ARNAGE II	6.8 V8 T		336 / 457	02.2002		RFN 58 LZDP5	A187		1,1	
BROOKLANDS	6.8 i V8			09.1992		RC 32 LS	A49	B19	0,8	L3
	7.0			09.1992		RC 32 LS5	A110		1,1	
CONTINENTAL	6.8 V8 Tous modèles (all models)			01.1984		RC 30 LS	A109		0,8	
CORNICHE	6.8 V8			03.1971	06.1984	RC 30 LS	A109		0,8	
EIGHT	6.8 V8			10.1980	09.1992	RC 30 LS	A109		0,8	
MULSANNE	6.8 V8			01.1981	08.1992	RC 32 LS	A49	B19	0,8	L3
	6.8 V8 Turbo			01.1981	08.1992	RC 32 LS	A49	B19	0,8	L3
SERIES T	6.8 V8			03.1985		RC 32 LS	A49	B19	0,8	L3
	6.8 V8 Turbo			03.1985		RC 32 LS	A49	B19	0,8	L3

(1) Available until end of stock

(a) 30 000 km

(b) 60 000 km

(c) Grey sticker on ignition coil

(d) Green sticker on ignition coil

(e) Hex 21 mm

(f) Hex 16 mm

(g) Recommended for

cold weather



EYQUEM



Box
10

Blister
4



F3-1

BERTONE

FREECLIMBER	1.6 i	M40B16	73/99	02.1992		RFC 58 LZ2E	A10	B31	0,9	F54
	2.0 i 4x4	M20B20 Cat	95/129	01.1991		RC 52 LZE	A67		0,7	L65
	2.7	BMW M20 B27	95/129	12.1990	12.1993	RC 52 LZE	A67		0,7	L65
	2.7 i 4x4	M20B27 Cat	95/129	01.1991		C 30 LS	A47		0,7	

BMW

ISETTA (100, 101, 102, 103)	250		9/12	01.1956	12.1962	C 72		A64		0,65
	300		10/14	05.1958	11.1963	C 72		A64		0,65
503 Cabriolet	3.2		103/140	01.1957	05.1961	C 62		A20		0,9
600 (111)	0.6		15/20	12.1957	05.1961	C 82 L		A105		0,65
700 (107)	0.7		22/30	01.1959	11.1966	C 82 L		A105		0,65
	0.7 A		24/33	01.1959	11.1966	C 82 L		A105		0,65
700 Coupé	0.7		24/33	08.1959	04.1964	C 82 L		A105		0,65
	0.7 S		29/39	08.1959	04.1964	C 82 L		A105		0,65
02 (E10)	1502	M10 B16	55/75	01.1975	07.1977	C 62 LS		A53	B5	0,7 L65
	1602	M10 B16	63/86	04.1971	07.1975	C 62 LS		A53	B5	0,7 L65
	1600/2	M10 B16	63/86	12.1967	12.1971	C 62 LS		A53	B5	0,7 L65
	1600 Ti	M10 B16	77/105	09.1967	11.1969	C 62 LS		A53	B5	0,7 L65
	1802	M10 B18	66/90	05.1971	07.1975	C 62 LS		A53	B5	0,7 L65
	2002	M10 B20	74/100	02.1968	07.1975	C 62 LS		A53	B5	0,7 L65
	2002 Ti	M10 B20	88/120	06.1968	04.1972	C 62 LS		A53	B5	0,7 L65
	2002 Tii	M10 B20	96/130	05.1971	07.1975	C 62 LS		A53	B5	0,7 L65
	2002 Turbo	M10 B20 (Turbo)	125/170	01.1974	07.1975	RC 72 LS		A32	B26	0,7 L87
02 Cabriolet (E10)	1600-2	M10 B16	63/86	12.1967	10.1971	RC 72 LS		A32	B26	0,7 L87
	2002	M10 B20	74/100	05.1971	07.1975	C 62 LS		A53	B5	0,7 L65
02 Touring (E6)	1600	M10 B16	63/86	05.1971	04.1973	C 62 LS		A53	B5	0,7 L65
	1802	M10 B18	66/90	05.1971	07.1975	C 62 LS		A53	B5	0,7 L65
	2002	M10 B20	74/100	05.1971	07.1975	C 62 LS		A53	B5	0,7 L65
	2002 Tii	M10 B20	96/130	01.1971	07.1975	C 62 LS		A53	B5	0,7 L65
1500-2000 (115, 116, 118, 121)	1500	M10 B15	59/80	10.1962	07.1966	C 62 LS		A53	B5	0,7 L65
	1500	M10 B15	59/80	09.1963	07.1966	C 62 LS		A53	B5	0,7 L65
	1600	M10 B16	61/83	04.1964	04.1968	C 62 LS		A53	B5	0,7 L65
	1800	M10 B18	66/90	07.1969	09.1971	C 62 LS		A53	B5	0,7 L65
	1800	M118	66/90	08.1963	09.1969	C 62 LS		A53	B5	0,7 L65
	1800 Ti	M118	81/110	10.1963	04.1968	C 62 LS		A53	B5	0,7 L65
	1800 Ti (TISA)	M118	96/131	10.1963	04.1968	C 62 LS		A53	B5	0,7 L65
	2000	M10 B18	66/90	01.1970	11.1972	C 62 LS		A53	B5	0,7 L65
	2000	M10 B20	74/100	09.1968	07.1972	C 62 LS		A53	B5	0,7 L65
	2000 Ti / Tilux	M10 B20	88/120	01.1966	07.1972	C 62 LS		A53	B5	0,7 L65
	2000 Tii	M10 B20	96/131	12.1969	07.1972	C 62 LS		A53	B5	0,7 L65
1600 GT Coupé	1600	M10 B16	77/105	10.1967	05.1969	C 62 LS		A53	B5	0,7 L65
2000-3.2 Coupe (E9)	2000 C/CA	M10 B20	74/101	10.1965	06.1970	C 62 LS		A53	B5	0,7 L65
	2000 CS	M10 B20	88/120	10.1965	06.1970	C 62 LS		A53	B5	0,7 L65
	2.5 CS	M30 B25	110/150	09.1974	03.1976	C 62 LS		A53	B5	0,7 L65
	2800 CS	M30 B28	125/170	01.1969	04.1971	C 62 LS		A53	B5	0,7 L65
	3.0 CS	M30 B30	132/180	05.1971	03.1976	C 62 LS		A53	B5	0,7 L65
	3.0 Csi	M30 B30	147/200	07.1971	03.1976	C 62 LS		A53	B5	0,7 L65
	3.2 CSL	M30 B32 (L-Jetronic)	152/206	01.1974	12.1975	C 62 LS		A53	B5	0,7 L65
2500-3.3 (E3)	2500	M30 B25	110/150	10.1968	07.1977	C 62 LS		A53	B5	0,7 L65
	2800	M30 B28	125/170	10.1968	07.1975	C 62 LS		A53	B5	0,7 L65
	2.8 L	M30 B28	125/170	02.1975	04.1977	C 62 LS		A53	B5	0,7 L65
	3.0 S	M30 B30	132/180	05.1971	04.1977	C 62 LS		A53	B5	0,7 L65
	3.0 L	M30 B30	132/180	02.1975	04.1977	C 62 LS		A53	B5	0,7 L65
	3.0 Si	M30 B30	143/194	10.1975	04.1977	C 62 LS		A53	B5	0,7 L65
	3.0 Si	M30 B30	147/200	07.1971	09.1975	C 62 LS		A53	B5	0,7 L65
	3.2 Li	M30 B32	147/200	10.1975	04.1977	C 62 LS		A53	B5	0,7 L65
	3.3 L	M30 B33	140/190	01.1974	09.1976	C 62 LS		A53	B5	0,7 L65
1 (E81)	116 i	N 45 B16 A	85/115	03.2007	09.2012	RFC 52 LZ4E		A159		1,6
	NEW 118 i	N46 B20 B	100/136	09.2006	09.2012	RFN 58 LZDPE5		A539		1,1
	NEW 120 i	N46 B20 C -N46 B20 B	115/156	09.2006	10.2011	RFN 58 LZDPE5		A539		1,1
	130 i	N52 B30 A-B30 B-B30 BF	190/258	09.2006	09.2012	RFC 58 HZEDP5		A191		1,1
	130 i	N52 B30 A-B30 B-B30 BF	195/265	09.2006	09.2012	RFC 58 HZEDP5		A191		1,1
1 (E87)	116 i	N 45 B16 A	85/115	11.2003	09.2012	RFC 52 LZ4E		A159		1,6

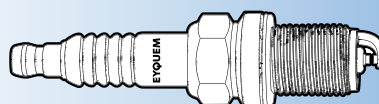

(1) Available until end of stock
 (a) 30 000 km
 (b) 60 000 km
 (c) Grey sticker on ignition coil
 (d) Green sticker on ignition coil

(e) Hex 21 mm
 (f) Hex 16 mm
 (g) Recommended for cold weather



kW/HP



Box
10

Blister
4



F3-1

BMW

	NEW	118 i	N46 B20 B	95/129	07.2004	02.2007	RFN 58 LZDPE5	A539	1,1		
	NEW	118 i	N46 B20 B	100/136	07.2004	09.2012	RFN 58 LZDPE5	A539	1,1		
	NEW	120 i	N46 B20 C-B20 B-B20 CC-B20 BD	110/150	11.2003	06.2011	RFN 58 LZDPE5	A539	1,1		
	NEW	120 i	N46 B20 A-B20 B-B20 C-B20 CC-B20 BD	115/156	11.2003	06.2011	RFN 58 LZDPE5	A539	1,1		
		130 i	N52 B30 A-B30 AF-B30 B-B30 BF	190/258	03.2005	06.2011	RFC 58 HZEDP5	A191	1,1		
		130 i	N52 B30 A-B30 AF-B30 B-B30 BF	195/265	03.2005	12.2009	RFC 58 HZEDP5	A191	1,1		
1 Cabriolet (E88)	NEW	118 i	N46 B20 B	100/136	09.2008	12.2013	RFN 58 LZDPE5	A539	1,1		
	NEW	120 i	N46 B20 C-B20 B-B20 E	115/156	09.2008	12.2013	RFN 58 LZDPE5	A539	1,1		
		125 i	N52 B30 A	160/218	03.2008	10.2013	RFC 58 HZEDP5	A191	1,1		
1 Coupe (E82)	NEW	120 i	N46 B20 B	115/156	09.2009	10.2013	RFN 58 LZDPE5	A539	1,1		
		125 i	N52 B30 A	160/218	10.2007	09.2013	RFC 58 HZEDP5	A191	1,1		
1 (F20)		114 i	N13 B16 A	75/102	11.2011		RXN 62 HSDP	A525	0,7		
		116 i	N13 B16 A	100/136	12.2010		RXN 62 HSDP	A525	0,7		
	NEW	116 i	B38 B15 A	80/109	03.2015		RXN 72 HSIPFSO	A550	0,75		
		118 i	N13 B16 A	125/170	11.2010		RXN 62 HSDP	A525	0,7		
	NEW	118 i	B38 B15 A	100/136	03.2015		RXN 72 HSIPFSO	A550	0,75		
	NEW	125 i	N20 B20 A	160/218	08.2011		RXN 72 HSDPFT	A540	0,8		
	NEW	125 i	B48 B20 B	165/224	09.2015		RXN 72 HSIPFSO	A550	0,75		
	NEW	125 i	N20 B20 A	175/238	03.2013		RXN 72 HSDPFT	A540	0,8		
	NEW	M 140 i	B58 B30 A	250/340	09.2015		RXN 72 HSIPFSO	A550	0,75		
	NEW	M 140 i xDrive	B58 B30 A	250/340	09.2015		RXN 72 HSIPFSO	A550	0,75		
1 (F21)		114 i	N13 B16 A	75/102	12.2011		RXN 62 HSDP	A525	0,7		
	NEW	116 i	B38 B15 A	80/109	03.2015		RXN 72 HSIPFSO	A550	0,75		
		116 i	N13 B16 A	100/136	12.2011		RXN 62 HSDP	A525	0,7		
	NEW	118 i	B38 B15 A	100/136	03.2015		RXN 72 HSIPFSO	A550	0,75		
		118 i	N13 B16 A	125/170	07.2012		RXN 62 HSDP	A525	0,7		
	NEW	125 i	N20 B20 A	160/218	12.2011		RXN 72 HSDPFT	A540	0,8		
	NEW	125 i	B48 B20 B	165/224	10.2015		RXN 72 HSIPFSO	A550	0,75		
	NEW	125 i	N20 B20 A	175/238	03.2013		RXN 72 HSDPFT	A540	0,8		
	NEW	125 i Flex	N20 B20 A	160/218	08.2014		RXN 72 HSDPFT	A540	0,8		
	NEW	M 140 i	B58 B30 A	250/340	10.2015		RXN 72 HSIPFSO	A550	0,75		
	NEW	M 140 i xDrive	B58 B30 A	250/340	09.2015		RXN 72 HSIPFSO	A550	0,75		
2 Active Tourer (F45)	NEW	216 i	B38 A15 A	75/102	02.2015	02.2018	RXN 72 HSIPFSO	A550	0,75		
	NEW	218 i	B38 A15 A	100/136	09.2014	02.2018	RXN 72 HSIPFSO	A550	0,75		
	NEW	220 i	B48 A20 A	141/192	09.2014		RXN 72 HSIPFSO	A550	0,75		
	NEW	225 i	B48 A20 B	170/231	09.2014		RXN 72 HSIPFSO	A550	0,75		
	NEW	225 i xDrive	B48 A20 B	170/231	03.2014		RXN 72 HSIPFSO	A550	0,75		
	NEW	225 xe	B38 A15 A	100/136	03.2016		RXN 72 HSIPFSO	A550	0,75		
	NEW	225 xe	B38 A15 A	165/224	11.2014		RXN 72 HSIPFSO	A550	0,75		
2 Cabriolet (F23)	NEW	218 i	B38 A15 A	100/136	03.2015		RXN 72 HSIPFSO	A550	0,75		
	NEW	220 i	N20 B20 B	135/184	11.2014		RXN 72 HSDPFT	A540	0,8		
	NEW	220 i	B48 B20 A	135/184	09.2015		RXN 72 HSIPFSO	A550	0,75		
	NEW	228 i	N20 B20 A	180/245	11.2014		RXN 72 HSDPFT	A540	0,8		
	NEW	230 i	B48 B20 B	185/252	09.2015		RXN 72 HSIPFSO	A550	0,75		
	NEW	M 240 i	B58 B30 A	250/340	09.2015		RXN 72 HSIPFSO	A550	0,75		
	NEW	M 240 i xDrive	B58 B30 A	250/340	09.2015		RXN 72 HSIPFSO	A550	0,75		
2 Coupé (F22, F87)	NEW	218 i	B38 A15 A	100/136	03.2015		RXN 72 HSIPFSO	A550	0,75		
	NEW	220 i	N20 B20 B	135/184	10.2013		RXN 72 HSDPFT	A540	0,8		
	NEW	220 i	B48 B20 A	135/184	09.2015		RXN 72 HSIPFSO	A550	0,75		
	NEW	228 i	N20 B20 A/N26 B20 A	180/245	07.2014		RXN 72 HSDPFT	A540	0,8		
	NEW	230 i	B48 B20 B	185/252	09.2015		RXN 72 HSIPFSO	A550	0,75		
	NEW	M 240 i xDrive	B58 B30 A	250/340	09.2015		RXN 72 HSIPFSO	A550	0,75		
2 Gran Tourer (F46)	NEW	216 i	B38 A15 A	75/102	07.2015		RXN 72 HSIPFSO	A550	0,75		
	NEW	218 i	B38 A15 A	100/136	03.2015		RXN 72 HSIPFSO	A550	0,75		
	NEW	220 i	B48 A20 A	141/192	03.2015		RXN 72 HSIPFSO	A550	0,75		
3 (E21)		315	M10B16 (164VB)	55/75	08.1975	03.1984	C 52 LS	A1	B1	0,7	L65
		316	M10B16 (164VA)	66/90	08.1975	08.1988	C 52 LS	A1	B1	0,7	L65
		316 i	M10B18 (184VC)	66/90	09.1980	08.1988	C 52 LS	A1	B1	0,7	L65

- (1) Available until end of stock
- (a) 30 000 km
- (b) 60 000 km
- (c) Grey sticker on ignition coil
- (d) Green sticker on ignition coil

- (e) Hex 21 mm
- (f) Hex 16 mm
- (g) Recommended for cold weather

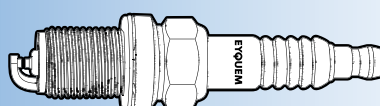

EYQUEM



Box 10
Blister 4



F3 → 1

BMW										
	318	M10B18 (184VA)	72/98	08.1975	08.1980	C 52 LS	A1	B1	0,7	L65
	318	M10B18	75-77/102-105		08.1987	C 52 LS	A1	B1	0,7	L65
	318 i	M10B18 (184VA)	77/105	11.1979	08.1982	C 52 LS	A1	B1	0,7	L65
	320	M10 B20	80/109	08.1975	08.1977	C 52 LS	A1	B1	0,7	L65
	320/6	M20 B20 (206VA)	90/122	09.1977	08.1982	C 52 LS	A1	B1	0,7	L65
	320 i	M10 B20	92/125	09.1975	08.1982	C 52 LS	A1	B1	0,7	L65
	323 i	M20B23 (236EA)	105/143	01.1978	08.1982	C 52 LS	A1	B1	0,7	L65
	323 i	M20B23 (236EA)	102-110/139-150	01.1978	08.1986	C 52 LS	A1	B1	0,7	L65
3 (E30)	315	M10 B16	55/75	09.1982	12.1991	C 52 LS	A1	B1	0,7	L65
	316 Ecotronic	M10 B18 (184VD)	66/90	09.1983	12.1990	C 52 LS	A1	B1	0,7	L65
	316	M10 B18 (184VC)	66/90	09.1982	12.1987	C 52 LS	A1	B1	0,7	L65
	316	M40 B16 (164E1)	73/99	09.1987	12.1990	RFC 52 LZE	A102		0,75	F54
	316	M40 B16 (164E1)	73/99	01.1991		RFC 58 LZ2E	A10	B31	0,9	F54
	316 i	M40 B 16 (164E1)	75/102	07.1988	06.1991	RFC 58 LZ2E	A10	B31	0,9	F54
	316 i	M10 B18 (184KA)	75/102	08.1987	08.1988	RFC 52 LZE	A102		0,75	F54
	318 i	M10 B18 (184KA)	75/102	12.1984	08.1987	C 52 LS	A1	B1	0,7	L65
	318 i	M10 B18 (184KA)	75/102	09.1987	08.1988	RFC 52 LZE	A102		0,75	F54
	318 i	M10 B18 (184EA)	77/105	09.1982	08.1987	C 52 LS	A1	B1	0,7	L65
	318 i	M40 B18 (184E1)	83/113	09.1987	06.1991	RFC 52 LZE	A102		0,75	F54
	318 i	M40 B18 (184E1)	85/115	09.1987	06.1991	RFC 52 LZE	A102		0,75	F54
	318 is	M42 B18 (184S1)	100/136	09.1989	08.1991	RFC 58 LZ2E	A10	B31	0,9	F54
	318 is	M42 B18 (184S1)	103/140	09.1989	08.1991	RFC 58 LZ2E	A10	B31	0,9	F54
	320 i	M20 B20 (206EB)	90/122	09.1982	12.1985	C 52 LS	A1	B1	0,7	L65
	320 i	M20 B20 (206EB)	92/125	09.1982	12.1985	C 52 LS	A1	B1	0,7	L65
	320 i	M20 B20 (206KA)	95/129	12.1985	06.1991	RC 52 LZE	A67		0,7	L65
	323 i	M20 B23 (236EC)	102/139	09.1982	08.1983	C 52 LS	A1	B1	0,7	L65
	323 i	M20 B23 (236EC)	110/150	09.1983	08.1986	C 52 LS	A1	B1	0,7	L65
	325 i	M20 B25 (256E1-E2-EX-K1)	125/170	12.1986	06.1991	RC 52 LZE	A67		0,7	L65
	325 iX	M20 B25 (256E1-E2-EX-K1)	125/170	12.1986	08.1991	RC 52 LZE	A67		0,7	L65
	325 i	M20 B25 (256E2)	126/171	09.1983	11.1989	RC 62 LS	A6	B17	0,7	L65
	325 iX	M20 B25 (256E2)	126/171	03.1986	12.1987	RC 62 LS	A6	B17	0,7	L65
	325e 2.7	M20B27 (276KA-KB)	90/122	10.1983	12.1988	RC 52 LZE	A67		0,7	L65
	325e 2.7	M20B27 (276KB)	95/129	01.1985	08.1987	RC 52 LZE	A67		0,7	L65
3 Cabriolet (E30)	318 i	M40 B18 (184E1)	83/113	09.1990	10.1993	RFC 52 LZE	A102		0,75	F54
	320 i	M20 B20	93/126	04.1986	10.1993	RC 52 LZE	A67		0,7	L65
	320 i	M20 B20 (206KA)	95/129	04.1986	10.1993	RC 52 LZE	A67		0,7	L65
	325 i	M20 B25 (256E2-EX-K1)	125/170	09.1987	10.1993	RC 52 LZE	A67		0,7	L65
	325 i	M20 B25 (256E2)	126/171	12.1985	12.1987	RC 62 LS	A6	B17	0,7	L65
3 Touring (E30)	316 i	M40 B16 (164E1)	73/100	09.1991	06.1994	RFC 58 LZ2E	A10	B31	0,9	F54
	316 i	M40 B16 (164E1)	75/102	09.1991	06.1994	RFC 58 LZ2E	A10	B31	0,9	F54
	318 i	M40 B18 (184E1)	83/113	04.1989	06.1994	RFC 58 LZ2E	A10	B31	0,9	F54
	318 i	M40 B18 (184E1)	85/115	09.1987	06.1991	RFC 58 LZ2E	A10	B31	0,9	F54
	320 i	M20 B20 (206KA)	95/129	01.1988	12.1991	RC 52 LZE	A67		0,7	L65
	325 i	M20 B25 (256K1)	125/170	07.1987	03.1993	RC 52 LZE	A67		0,7	L65
	325 iX	M20 B25 (256K1)	125/170	06.1988	10.1993	RC 52 LZE	A67		0,7	L65
3 (E36)	316 i	M40 B16 (164E1)	73/99	09.1990	09.1993	RFC 58 LZ2E	A10	B31	0,9	F54
	316 i	M43 B16 (164E2)	75/102	09.1990	09.1993	RFC 58 LZ2E	A10	B31	0,9	F54
	316 i	M43 B16 (164E2)	75/102	07.1993	02.1998	RFC 58 LZ2E	A10	B31	0,9	F54
	318 i	M40 B18 (184E1)	83/113	12.1990	10.1993	RFC 58 LZ2E	A10	B31	0,9	F54
	318 i	M40 B18 (184E2)	85/115	10.1993	02.1998	RFC 58 LZ2E	A10	B31	0,9	F54
	318 is	M42 B18 (184S1)	103/140	03.1993	02.1998	RFC 58 LZ2E	A10	B31	0,9	F54
	318 is	M44 B19 (194S1)	103/140	09.1995	02.1998	RFC 58 LZ2E	A10	B31	0,9	F54
	320 i	M50 B20 (206S1-S2-S3)	110/150	09.1990	02.1998	RFC 58 LZ2E	A10	B31	0,9	F54
	323 i 2.5	M52 B25 (256S3)	125/170	03.1995	02.1998	RFC 58 LZ2E	A10	B31	0,9	F54
	325 i	M52 B25 (256S1-S2)	140/192	09.1990	09.1995	RFC 58 LZ2E	A10	B31	0,9	F54
	328 i	M52 B28 (286S1)	142/193	01.1995	02.1998	RFC 58 LZ2E	A10	B31	0,9	F54
3 Cabriolet (E36)	318 i	M43 B18 (184E2)	85/115	01.1994	04.1999	RFC 58 LZ2E	A10	B31	0,9	F54
	320 i	M50 B20 (206S1-S2-S3)	110/150	12.1993	04.1999	RFC 58 LZ2E	A10	B31	0,9	F54
	323 i	M52 B25 (256S3)	125/170	06.1995	04.1999	RFC 58 LZ2E	A10	B31	0,9	F54
	325 i	M50 B25 (256S2)	141/192	03.1993	03.1995	RFC 58 LZ2E	A10	B31	0,9	F54
	328 i	M52 B28 (286S1)	142/193	03.1995	04.1999	RFC 58 LZ2E	A10	B31	0,9	F54
3 Compact (E36)	316 i	M43 B16 (164E2)	75/102	03.1994	08.2000	RFC 58 LZ2E	A10	B31	0,9	F54
	316 i	M43 B19 (194E1)	77/105	12.1998	08.2000	RFC 58 LZP4	A193		1,5	
	316 g	M43 B16 (164E2)	75/102	03.1994	08.2000	RFC 58 LZ2E	A10	B31	0,9	F54
	318 ti	M42 B18 (184S1)	103/140	11.1994	08.1995	RFC 58 LZ2E	A10	B31	0,9	F54

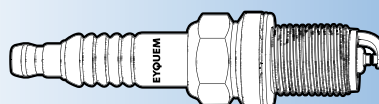

(1) Available until end of stock

- (a) 30 000 km
- (b) 60 000 km
- (c) Grey sticker on ignition coil
- (d) Green sticker on ignition coil

- (e) Hex 21 mm
- (f) Hex 16 mm
- (g) Recommended for cold weather



KW/HP



Box
10

Blister
4



F3-D1

BMW

	318 ti	M44 B19 (194S1)	103/140	07.1995	08.2000	RFC 58 LZ2E	A10	B31	0,9	F54
	323 ti	M52 B25 (256S3)	125/170	08.1997	08.2000	RFC 58 LZ2E	A10	B31	0,9	F54
3 Coupé (E36)	316 i	M43 B16 (164E2)	75/102	03.1993	04.1999	RFC 58 LZ2E	A10	B31	0,9	F54
	318 is	M42 B18 (184S1)	103/140	03.1992	10.1995	RFC 58 LZ2E	A10	B31	0,9	F54
	318 is	M44 B19 (194S1)	103/140	09.1995	04.1999	RFC 58 LZ2E	A10	B31	0,9	F54
	320 i	M50 B20 (206S1-S2-S3)	110/150	03.1992	04.1999	RFC 58 LZ2E	A10	B31	0,9	F54
	323 i	M50 B25 (256S3)	125/170	03.1995	04.1999	RFC 58 LZ2E	A10	B31	0,9	F54
	325 i	M50 B25 (256S1-S2)	141/192	03.1992	04.1999	RFC 58 LZ2E	A10	B31	0,9	F54
	328 i	M52 B28 (286S1)	142/193	01.1995	04.1999	RFC 58 LZ2E	A10	B31	0,9	F54
3 Touring (E36)	316 i	M43 B16 (164E2)	75/102	01.1996	10.1999	RFC 58 LZ2E	A10	B31	0,9	F54
	318 i	M43 B18 (184E2)	85/116	07.1995	10.1999	RFC 58 LZ2E	A10	B31	0,9	F54
	320 i	M52 B20 (206S3)	110/150	01.1995	10.1999	RFC 58 LZ2E	A10	B31	0,9	F54
	323 i	M52 B25 (256S3)	125/170	09.1995	10.1999	RFC 58 LZ2E	A10	B31	0,9	F54
	328 i	M52 B28 (286S1)	142/193	01.1995	10.1999	RFC 58 LZ2E	A10	B31	0,9	F54
3 (E46)	316 i	M43 B16 (164E3)	77/105	04.2000	02.2005	RFC 58 L郑4	A193		1,5	
	316 i	N40 B16 A	85/115	06.2002	03.2004	RFC 58 L郑4	A193		1,5	
	NEW 316 i	N45 B16 A	85/115	04.2004	02.2005	RFN 58 LZDPE5	A539		1,1	
	316 i	N42 B18 A	85/115	02.2002	03.2004	RFC 58 L郑4	A193		1,5	
	NEW 316 i	N46 B18 A	85/115	04.2004	02.2005	RFN 58 LZDPE5	A539		1,1	
	316 i	M43 B19 (194E1)	77/105	09.1998	02.2005	RFC 58 L郑4	A193		1,5	
	318 i	M43 B19 (194E1)	87/118	02.1998	09.2001	RFC 58 L郑4	A193		1,5	
	318 i	N42 B20	105/143	09.2001	02.2005	RFC 58 L郑4	A193		1,5	
	NEW 318 i	N46 B20-B20 A	105/143	09.2001	02.2005	RFN 58 LZDPE5	A539		1,1	
	320 i	M52 B20 (206S4)	110/150	03.1998	09.2000	RFC 58 L郑4	A193		1,5	
	320 i	M54 B22 (226S1)	125/170	09.2000	02.2005	RFC 58 L郑4	A193		1,5	
	323 i	M52 B25 (256S4)	125/170	03.1998	09.2000	RFC 58 L郑4	A193		1,5	
	325 i, xi	M54 B25 (256S5)	141/192	09.2000	02.2005	RFC 58 L郑4	A193		1,5	
	328 i	M52 B28 (286S2)	142/193	02.1998	02.2000	RFC 58 L郑4	A193		1,5	
	330 i, xi	M54 B30 (306S3)	170/231	06.2000	02.2005	RFC 58 L郑4	A193		1,5	
3 Cabriolet (E46)	318 Ci	N42 B20 A	105/143	09.2001	12.2007	RFC 58 L郑4	A193		1,5	
	NEW 318 Ci	N46 B20 A	105/143	09.2001	12.2007	RFN 58 LZDPE5	A539		1,1	
	NEW 318 Ci	N46 B20 A-B20 B	110/150	02.2005	12.2007	RFN 58 LZDPE5	A539		1,1	
	320 Ci	M54 B22 (226S1)	125/170	09.2000	12.2007	RFC 58 L郑4	A193		1,5	
	323 Ci	M52 B25 (256S4)	125/170	04.2000	09.2000	RFC 58 L郑4	A193		1,5	
	325 Ci	M54 B25 (256S5)	141/192	09.2000	12.2007	RFC 58 L郑4	A193		1,5	
	330 Ci	M54 B30 (306S3)	170/231	06.2000	12.2007	RFC 58 L郑4	A193		1,5	
3 Compact (E46)	316 ti	N40 B16 A	85/115	06.2002	03.2004	RFC 58 L郑4	A193		1,5	
	NEW 316 ti	N45 B16 A	85/115	04.2004	02.2005	RFN 58 LZDPE5	A539		1,1	
	316 ti	N42 B18	85/115	06.2001	03.2004	RFC 58 L郑4	A193		1,5	
	NEW 316 ti	N46 B18 A	85/115	04.2004	02.2005	RFN 58 LZDPE5	A539		1,1	
	318 ti	N42 B20	105/143	09.2001	03.2004	RFC 58 L郑4	A193		1,5	
	NEW 318 ti	N46 B20 A	105/143	04.2004	02.2005	RFN 58 LZDPE5	A539		1,1	
	325 ti	M54 B25 (256S5)	141/192	06.2001	02.2005	RFC 58 L郑4	A193		1,5	
3 Coupé (E46)	316 Ci	M43 B16 (164E3)	77/105	04.2000	07.2006	RFC 58 L郑4	A193		1,5	
	NEW 316 Ci	N45 B16 A	85/115	06.2002	07.2006	RFN 58 LZDPE5	A539		1,1	
	318 Ci	M43 B19 (194E1)	87/118	11.1999	02.2001	RFC 58 L郑4	A193		1,5	
	318 Ci	N42 B20 A	105/143	09.2001	07.2006	RFC 58 L郑4	A193		1,5	
	NEW 318 Ci	N46 B20 A	105/143	09.2001	07.2006	RFN 58 LZDPE5	A539		1,1	
	NEW 318 Ci	N46 B20 A	110/150	03.2005	07.2006	RFN 58 LZDPE5	A539		1,1	
	320 Ci	M52 B20 (206S4)	110/150	08.1999	09.2000	RFC 58 L郑4	A193		1,5	
	320 Ci	M54 B22 (226S1)	125/170	09.2000	07.2006	RFC 58 L郑4	A193		1,5	
	323 Ci	M52 B25 (256S4)	125/170	04.1999	09.2000	RFC 58 L郑4	A193		1,5	
	325 Ci	M54 B25 (256S5)	141/192	09.2000	07.2006	RFC 58 L郑4	A193		1,5	
	328 Ci	M52 B28 (286S2)	142/193	04.1999	06.2000	RFC 58 L郑4	A193		1,5	
	330 Ci, xi	M54 B30 (306S3)	170/231	06.2000	07.2006	RFC 58 L郑4	A193		1,5	
3 Touring (E46)	316 i	N42 B18 A	85/115	03.2002	03.2004	RFC 58 L郑4	A193		1,5	
	NEW 316 i	N45 B16 A	85/115	04.2004	02.2005	RFN 58 LZDPE5	A539		1,1	
	NEW 316 i	N46 B18 A	85/115	03.2002	02.2005	RFN 58 LZDPE5	A539		1,1	
	318 i	M43 B19 (194E1)	87/118	10.1999	09.2001	RFC 58 L郑4	A193		1,5	
	318 i	N42 B20 A	105/143	09.2001	03.2004	RFC 58 L郑4	A193		1,5	
	NEW 318 i	N46 B20 A	105/143	04.2004	02.2005	RFN 58 LZDPE5	A539		1,1	
	320 i	M52 B20 (206S4)	110/150	10.1999	09.2000	RFC 58 L郑4	A193		1,5	
	320 i	M54 B22 (226S1)	125/170	09.2000	02.2005	RFC 58 L郑4	A193		1,5	
	325 i, xi	M54 B25 (256S5)	141/192	09.2000	02.2005	RFC 58 L郑4	A193		1,5	
	328 i	M52 B28 (286S2)	142/193	10.1999	06.2000	RFC 58 L郑4	A193		1,5	

- (1) Available until end of stock
- (a) 30 000 km
- (b) 60 000 km
- (c) Grey sticker on ignition coil
- (d) Green sticker on ignition coil

- (e) Hex 21 mm
- (f) Hex 16 mm
- (g) Recommended for cold weather

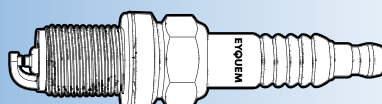

EYQUEM



Box 10
Blister 4



F3D1

BMW										
3 (E90)	330 i, xi	M54 B30 (306S3)	170/231	06.2000	02.2005	RFC 58 LZP4	A193	1,5		
	316 i	N45 B16 A	85/115	01.2005	10.2011	RFC 52 LZ4E	A159	1,6		
	NEW 318 i	N46 B20 B	95/129	09.2005	08.2007	RFN 58 LZDPE5	A539	1,1		
	NEW 318 i	N46 B20 B	100/136	06.2007	10.2011	RFN 58 LZDPE5	A539	1,1		
	NEW 320 i	N46 B20 A-B20 B-B20 C	110/150	01.2005	03.2007	RFN 58 LZDPE5	A539	1,1		
	NEW 320 i	N46 B20 C-B20 B-B20 CC-B20 CD-B20 E	115/156	03.2007	12.2011	RFN 58 LZDPE5	A539	1,1		
	323 i	N52 B25 A - N52N B25 A	130/177	04.2006	06.2007	RFC 58 HZEDP5	A191	1,1		
	325 i	N52 B25 A	160/218	01.2005	12.2011	RFC 58 HZEDP5	A191	1,1		
	325 xi	N52 B25 A	160/218	09.2005	12.2011	RFC 58 HZEDP5	A191	1,1		
	328 i	N52N B30 A	187/254	07.2005	11.2007	RFC 58 HZEDP5	A191	1,1		
3 Cabriolet (E93)	330 i, xi	N52 B30 A-N52 B30 B-B30 BF	190/258	01.2005	08.2007	RFC 58 HZEDP5	A191	1,1		
	NEW 320 i	N46 B20 A	110/150	03.2007	08.2013	RFN 58 LZDPE5	A539	1,1		
	NEW 320 i	N46 B20 B	115/156	03.2007	08.2013	RFN 58 LZDPE5	A539	1,1		
	325 i	N52 B25 A	160/218	03.2007	12.2013	RFC 58 HZEDP5	A191	1,1		
	3 Coupe (E92)	NEW 320 i	N46 B20 A	110/150	11.2006	06.2007	RFN 58 LZDPE5	A539	1,1	
		325 i, xi	N52 B25 A	160/218	09.2006	12.2013	RFC 58 HZEDP5	A191	1,1	
		330 i, xi	N52 B30 A	200/272	09.2006	12.2013	RFC 58 HZEDP5	A191	1,1	
		3 Touring (E91)	NEW 318 i	N46 B20 B	95/129	01.2006	08.2007	RFN 58 LZDPE5	A539	1,1
			NEW 318 i	N46 B20 B	100/136	09.2007	03.2012	RFN 58 LZDPE5	A539	1,1
			NEW 320 i	N46 B20A-B20 C	110/150	09.2005	06.2012	RFN 58 LZDPE5	A539	1,1
323 i			N52N B25 A	130/177	04.2006	06.2007	RFC 58 HZEDP5	A191	1,1	
323 i			N52N B25 A	140/190	09.2006	07.2008	RFC 58 HZEDP5	A191	1,1	
325 i			N52 B25 A	160/218	12.2004	12.2010	RFC 58 HZEDP5	A191	1,1	
325 xi			N52 B25 A	160/218	09.2005	08.2011	RFC 58 HZEDP5	A191	1,1	
330 i, xi	N52 B30 A		190/258	09.2005	08.2007	RFC 58 HZEDP5	A191	1,1		
3 (F30, F80)	316 i		N13 B16 A	100/136	10.2012		RXN 62 HSDP	A525	0,7	
	NEW 318 i		B38 B15 A	100/136	07.2015		RXN 72 HSIPFSO	A550	0,75	
	320 i	N13 B16 A	125/170	02.2012		RXN 62 HSDP	A525	0,7		
	NEW 320 i	N20 B20 A	135/184	04.2011		RXN 72 HSDPFT	A540	0,8		
	NEW 320 i	B48 B20 A	135/184	07.2015		RXN 72 HSIPFSO	A550	0,75		
	NEW 320 i xDrive	B48 B20 A	135/184	07.2015		RXN 72 HSIPFSO	A550	0,75		
	NEW 320 i Active Flex		135/184	02.2012		RXN 72 HSDPFT	A540	0,8		
	NEW 320 i xDrive	N20 B20 A/N20 B20 B	135/184	05.2011	06.2015	RXN 72 HSDPFT	A540	0,8		
	NEW 328 i	N20 B20 A	180/245	04.2011	08.2015	RXN 72 HSDPFT	A540	0,8		
	NEW 328 i xDrive	N20 B20 A	180/245	10.2011	06.2015	RXN 72 HSDPFT	A540	0,8		
	NEW 330 e	B48 B20 A	135/184	07.2015		RXN 72 HSIPFSO	A550	0,75		
	NEW 330 e	B48 B20 A	185/252	07.2015		RXN 72 HSIPFSO	A550	0,75		
	NEW 330 i	B48 B20 B/ B46 B20 B	185/252	07.2015		RXN 72 HSIPFSO	A550	0,75		
	NEW 330 i xDrive	B48 B20 B	185/252	07.2015		RXN 72 HSIPFSO	A550	0,75		
	NEW 340 i	B58 B30 A	240/326	07.2015		RXN 72 HSIPFSO	A550	0,75		
	NEW 340 i	B58 B30 A	265/360	10.2015		RXN 72 HSIPFSO	A550	0,75		
	NEW 340 i x Drive	B58 B30 A	240/326	07.2015		RXN 72 HSIPFSO	A550	0,75		
	NEW 340 i x Drive	B58 B30 A	265/360	10.2015		RXN 72 HSIPFSO	A550	0,75		
	3 Gran Turismo (F34)	NEW 320 i	N20 B20 A/N20 B20 B	135/184	07.2012		RXN 72 HSDPFT	A540	0,8	
		NEW 320 i xDrive	N20 B20 A/N20 B20 B	135/184	11.2012		RXN 72 HSDPFT	A540	0,8	
NEW 320 i		B48 B20 A	135/184	06.2016		RXN 72 HSIPFSO	A550	0,75		
NEW 320 i xDrive		B48 B20 A	135/184	06.2016		RXN 72 HSIPFSO	A550	0,75		
NEW 328 i		N20 B20 A/N26 B20 A	180/245	08.2012		RXN 72 HSDPFT	A540	0,8		
NEW 328 i xDrive		N20 B20 A/N26 B20 A	180/245	03.2013		RXN 72 HSDPFT	A540	0,8		
NEW 330 i		B48 B20 B	185/252	06.2016		RXN 72 HSIPFSO	A550	0,75		
NEW 330 i xDrive		B48 B20 B	185/252	06.2016		RXN 72 HSIPFSO	A550	0,75		
NEW 340 i		B58 B30 A	240/326	06.2016		RXN 72 HSIPFSO	A550	0,75		
NEW 340 i		B58 B30 A	265/360	07.2016		RXN 72 HSIPFSO	A550	0,75		
NEW 340 i x Drive		B58 B30 A	240/326	07.2016		RXN 72 HSIPFSO	A550	0,75		
NEW 340 i x Drive		B58 B30 A	265/360	07.2016		RXN 72 HSIPFSO	A550	0,75		
3 Touring (F31)		316 i	N13 B16 A	100/136	03.2013		RXN 62 HSDP	A525	0,7	
		NEW 318 i	B38 B15 A	100/136	07.2015		RXN 72 HSIPFSO	A550	0,75	
		NEW 320 i, xDrive	N20 B20 B	135/184	02.2012		RXN 72 HSDPFT	A540	0,8	
	NEW 320 i	B48 B20 A	135/184	07.2015		RXN 72 HSIPFSO	A550	0,75		
	NEW 320 i xDrive	B48 B20 A	135/184	07.2015		RXN 72 HSIPFSO	A550	0,75		
	NEW 328 i, xDrive	N20 B20 A - N26 B20 A	180/245	06.2012		RXN 72 HSDPFT	A540	0,8		
	NEW 330 i	B48 B20 A	185/252	07.2015		RXN 72 HSIPFSO	A550	0,75		

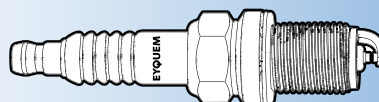

- (1) Available until end of stock
- (a) 30 000 km
- (b) 60 000 km
- (c) Grey sticker on ignition coil
- (d) Green sticker on ignition coil

- (e) Hex 21 mm
- (f) Hex 16 mm
- (g) Recommended for cold weather



KW/HP



Box
10

Blister
4



F3-D1

BMW

	NEW	330 i xDrive	B48 B20 B	185/252	07.2015		RXN 72 HSIPF50	A550	0.75		
	NEW	340 i	B58 B30 A	240/326	07.2015		RXN 72 HSIPF50	A550	0.75		
	NEW	340 i	B58 B30 A	265/360	07.2015		RXN 72 HSIPF50	A550	0.75		
	NEW	340 i x Drive	B58 B30 A	240/326	07.2015		RXN 72 HSIPF50	A550	0.75		
	NEW	340 i x Drive	B58 B30 A	265/360	07.2015		RXN 72 HSIPF50	A550	0.75		
4 Coupe (F32, F82)	NEW	418 i	B38 B15 A	100/136	02.2016		RXN 72 HSIPF50	A550	0.75		
	NEW	420 i	N20 B20 A - N20 B20 B	135/184	11.2013		RXN 72 HSDPFT	A540	0,8		
	NEW	420 i xDrive	N20 B20 A - N20 B20 B	135/184	11.2013		RXN 72 HSDPFT	A540	0,8		
	NEW	420 i	B48 B20 A	135/184	02.2016		RXN 72 HSIPF50	A550	0.75		
	NEW	420 i xDrive	B48 B20 A	135/184	02.2016		RXN 72 HSIPF50	A550	0.75		
	NEW	428 i	N20 B20 A/N26 B20 A	180/245	07.2013		RXN 72 HSDPFT	A540	0,8		
	NEW	428 i xDrive	N20 B20 A/N26 B20 A	180/245	07.2013		RXN 72 HSDPFT	A540	0,8		
	NEW	430 i	B48 B20 B	185/252	03.2016		RXN 72 HSIPF50	A550	0.75		
	NEW	430 i xDrive	B48 B20 B	185/252	03.2016		RXN 72 HSIPF50	A550	0.75		
	NEW	440 i	B58 B30 A	240/326	03.2016		RXN 72 HSIPF50	A550	0.75		
	NEW	440 i	B58 B30 A	265/360	03.2016		RXN 72 HSIPF50	A550	0.75		
	NEW	440 i xDrive	B58 B30 A	240/326	03.2016		RXN 72 HSIPF50	A550	0.75		
	NEW	440 i xDrive	B58 B30 A	265/360	03.2016		RXN 72 HSIPF50	A550	0.75		
4 Cabriolet (F33, F83)	NEW	420 i	N20 B20 B	135/184	07.2014		RXN 72 HSDPFT	A540	0,8		
	NEW	420 i	B48 B20 A	135/184	02.2016		RXN 72 HSIPF50	A550	0.75		
	NEW	428 i	N20 B20 A/N26 B20 A	180/245	10.2013		RXN 72 HSDPFT	A540	0,8		
	NEW	428 i xDrive	N20 B20 A	180/245	01.2014		RXN 72 HSDPFT	A540	0,8		
	NEW	430 i	B48 B20 B	185/252	03.2016		RXN 72 HSIPF50	A550	0.75		
	NEW	430 i xDrive	B48 B20 B	185/252	03.2016		RXN 72 HSIPF50	A550	0.75		
	NEW	440 i	B58 B30 A	240/326	03.2016		RXN 72 HSIPF50	A550	0.75		
	NEW	440 i	B58 B30 A	265/360	03.2016		RXN 72 HSIPF50	A550	0.75		
	NEW	440 i xDrive	B58 B30 A	240/326	03.2016		RXN 72 HSIPF50	A550	0.75		
	NEW	440 i xDrive	B58 B30 A	265/360	03.2016		RXN 72 HSIPF50	A550	0.75		
4 Gran Coupe (F36)	NEW	418 i	B38 B15 A	100/136	07.2015		RXN 72 HSIPF50	A550	0.75		
	NEW	420 i, xDrive	N20 B20 B	135/184	03.2014		RXN 72 HSDPFT	A540	0,8		
	NEW	420 i	B48 B20 A	135/184	03.2016		RXN 72 HSIPF50	A550	0.75		
	NEW	420 i xDrive	B48 B20 A	135/184	02.2016		RXN 72 HSIPF50	A550	0.75		
	NEW	428 i, xDrive	N20 B20 A/N26 B20 A	180/245	03.2014		RXN 72 HSDPFT	A540	0,8		
	NEW	430 i	B48 B20 B	185/252	03.2016		RXN 72 HSIPF50	A550	0.75		
	NEW	440 i	B58 B30 A	240/326	03.2016		RXN 72 HSIPF50	A550	0.75		
	NEW	440 i	B58 B30 A	265/360	03.2016		RXN 72 HSIPF50	A550	0.75		
	NEW	440 i xDrive	B58 B30 A	240/326	03.2016		RXN 72 HSIPF50	A550	0.75		
	NEW	440 i xDrive	B58 B30 A	265/360	03.2016		RXN 72 HSIPF50	A550	0.75		
5 (E12)		518	M10 B18 (184BV)	66/90	07.1974	07.1975	RC 72 LS	A32	B26	0,7	L87
		518	M10 B18 (184BV)	66/90	08.1975	05.1981	C 52 LS	A1	B1	0,7	L65
		520	M10 B20	85/115	08.1972	08.1977	C 62 LS	A53	B5	0,7	L65
		520	M10 B20	92/125	10.1975	05.1977	C 62 LS	A53	B5	0,7	L65
		520 i	M10 B20	96/131	08.1972	10.1975	C 62 LS	A53	B5	0,7	L65
		520/6	M20 B20 (206VA)	90/122	09.1977	05.1981	C 52 LS	A1	B1	0,7	L65
		525	M30 B25	107/146	08.1973	10.1976	C 62 LS	A53	B5	0,7	L65
		525	M30 B25 (256VA)	110/150	08.1976	05.1981	C 62 LS	A53	B5	0,7	L65
		528	M30 B28 (256VA)	121/165	01.1975	08.1977	C 62 LS	A53	B5	0,7	L65
		528 i	M30 B28	130/177	04.1977	05.1981	C 52 LS	A1	B1	0,7	L65
		528 i	M30 B28	135/184	04.1977	05.1981	C 52 LS	A1	B1	0,7	L65
		M 535 i	M30 B35	160/218	06.1980	08.1981	C 52 LS	A1	B1	0,7	L65
5 (E28)		518	M10 B18 (184VC/184VD)	66/90	06.1981	08.1984	C 52 LS	A1	B1	0,7	L65
		518 i	M10 B18 (184EB)	77/105	05.1981	12.1987	C 52 LS	A1	B1	0,7	L65
		520 i	M20 B20 (206EA)	92/125	06.1981	12.1987	C 52 LS	A1	B1	0,7	L65
		520 i	M20 B20 (206KA)	95/129	08.1985	12.1987	RC 52 LZ	A67		0,7	L65
		525 i	M30 B25 (25EVA)	110/150	06.1981	12.1987	C 52 LS	A1	B1	0,7	L65
		525 e	M20 B27 (276EB-276KA-276KE)	90/122	09.1981	12.1987	RC 52 LZ	A67		0,7	L65
		525 e	M20 B27 (276EA)	92/125	05.1983	12.1987	RC 52 LZ	A67		0,7	L65
		525 e	M20 B27 (276KB)	95/129	12.1984	12.1987	RC 52 LZ	A67		0,7	L65
		528 i	M30 B28 (286EA)	135/184	06.1981	12.1987	C 52 LS	A1	B1	0,7	L65
		535 i, M 535 i	M30 B34 (346KA)	136/185	01.1985	12.1987	RC 52 LZ	A67		0,7	L65
		535 i, M 535 i	M30 B35	141/192	01.1985	12.1987	RC 52 LZ	A67		0,7	L65

(1) Available until end of stock

(a) 30 000 km

(b) 60 000 km

(c) Grey sticker on ignition coil

(d) Green sticker on ignition coil

(e) Hex 21 mm

(f) Hex 16 mm

(g) Recommended for cold weather



EYQUEM



Box 10
Blister 4



F3 → 1

BMW										
	535 i, M 535 i	M30 B34 (346EC)	160/218	01.1985	12.1987	C 52 LS	A1	B1	0,7	L65
5 (E34)	518		65/88	08.1989	09.1995	RFC 58 LZ2E	A10	B31	0,9	F54
	518 i	M40 B18 (184E1)	83/113	08.1989	09.1995	RFC 58 LZ2E	A10	B31	0,9	F54
	518 i	M43 B18 (184E2)	85/115	08.1989	09.1995	RFC 58 LZ2E	A10	B31	0,9	F54
	520 i	M20 B20 (206KA)	95/129	01.1988	08.1991	RC 52 LZE	A67		0,7	L65
	520 i 24V	M50 B20 (206S1-S2)	110/150	09.1989	09.1995	RFC 58 LZ2E	A10	B31	0,9	F54
	525 i	M20 B25 (206K1)	125/170	01.1988	08.1991	RC 52 LZE	A67		0,75	L65
	525 i 24V	M50 B25 (256S2)	141/192	09.1989	09.1995	RFC 58 LZ2E	A10	B31	0,9	F54
	525 ix 24V	M50 B25 (256S1-S2)	141/192	10.1991	09.1995	RFC 58 LZ2E	A10	B31	0,9	F54
	530 i	M30 B30 (306KA)	138/188	01.1988	08.1991	RC 52 LZE	A67		0,75	L65
	530 i V8	M60 B30 (308S1)	160/218	09.1992	09.1996	RFC 58 LZ2E	A10	B31	0,9	F54
	535 i	M30 B34 (346KB)	155/211	01.1988	09.1995	RC 52 LZE	A67		0,75	L65
	540 i V8	M60 B40 (408S1)	210/286	09.1992	09.1995	RFC 58 LZ2E	A10	B31	0,9	F54
5 Touring (E34)	518 i	M43 B18 (184E2)	83/113	03.1993	09.1994	RFC 58 LZ2E	A10	B31	0,9	F54
	518 i	M43 B18 (184E2)	85/115	09.1994	01.1997	RFC 58 LZ2E	A10	B31	0,9	F54
	518 g	M43 B18 (184E2)	85/115	11.1995	06.1996	RFC 58 LZ2E	A10	B31	0,9	F54
	520 i	M50 B20 (206S1-S2)	110/150	11.1991	01.1997	RFC 58 LZ2E	A10	B31	0,9	F54
	525 i	M50 B25 (256S1-S2)	141/192	11.1991	01.1997	RFC 58 LZ2E	A10	B31	0,9	F54
	525 ix	M50 B25 (256S1-S2)	141/192	02.1992	01.1997	RFC 58 LZ2E	A10	B31	0,9	F54
	530 i V8	M60 B30 (308S1)	160/218	09.1992	01.1997	RFC 58 LZ2E	A10	B31	0,9	F54
	540 i	M60 B40 (408S1)	210/286	09.1993	01.1997	RFC 58 LZ2E	A10	B31	0,9	F54
5 (E39)	520 i	M52 B20 (206S3)	100/136	04.1999	06.2003	RFC 58 LZP4	A193		1,5	
	520 i	M52 B20 (206S3)	110/150	01.1996	08.1998	RFC 58 LZ2E	A10	B31	0,9	F54
	520 i	M52 B20 (206S3)	110/150	09.1998	09.2000	RFC 58 LZP4	A193		1,5	
	520 i	M54 B22 (226S1)	125/170	09.2000	06.2003	RFC 58 LZP4	A193		1,5	
	523 i	M52 B25 (256S3)	125/170	11.1995	08.1998	RFC 58 LZ2E	A10	B31	0,9	F54
	523 i	M52 B25 (256S3)	125/170	09.1998	09.2000	RFC 58 LZP4	A193		1,5	
	525 i	M54 B25 (256S5)	141/192	09.2000	06.2003	RFC 58 LZP4	A193		1,5	
	528 i	M52 B28 (286S1-S2)	142/193	11.1995	08.1998	RFC 58 LZ2E	A10	B31	0,9	F54
	528 i	M52 B28 (286S1-S2)	142/193	09.1998	09.2000	RFC 58 LZP4	A193		1,5	
	530 i	M54 B30 (306S3)	170/231	09.2000	06.2003	RFC 58 LZP4	A193		1,5	
	535 i	M62 B35 (358S1-S2)	173/235	04.1996	08.1998	RFC 58 LZ2E	A10	B31	0,9	F54
	535 i	M62 B35 (358S1-S2)	173/235	09.1998	03.1999	RFC 58 LZP4	A193		1,5	
	535 i	M62 B35 (358S2)	180/245	04.1999	06.2003	RFC 58 LZP4	A193		1,5	
	540 i	M62 B44 (448S1)	210/286	04.1996	08.1998	RFC 58 LZ2E	A10	B31	0,9	F54
	540 i	M62 B44 (448S1)	210/286	09.1998	06.2003	RFC 58 LZP4	A193		1,5	
	M5	S62 B50 (508S1)	294/400	10.1998	06.2003	RFC 58 LZP4	A193		1,5	
5 Touring (E39)	520 i	M52 B20 (206S3)	100/136	04.1999	05.2004	RFC 58 LZP4	A193		1,5	
	520 i	M52 B20 (206S3)	110/150	01.1997	08.1998	RFC 58 LZ2E	A10	B31	0,9	F54
	520 i	M52 B20 (206S3)	110/150	09.1998	09.2000	RFC 58 LZP4	A193		1,5	
	520 i	M54 B22 (226S1)	125/170	09.2000	05.2004	RFC 58 LZP4	A193		1,5	
	523 i	M52 B25 (256S3)	125/170	01.1997	08.1998	RFC 58 LZ2E	A10	B31	0,9	F54
	523 i	M52 B25 (256S3)	125/170	09.1998	09.2000	RFC 58 LZP4	A193		1,5	
	525 i	M54 B25 (256S5)	141/192	09.2000	05.2004	RFC 58 LZP4	A193		1,5	
	528 i	M52 B28 (286S1-S2)	142/193	01.1997	09.2000	RFC 58 LZP4	A193		1,5	
	530 i	M54 B30 (306S3)	170/231	09.2000	05.2004	RFC 58 LZP4	A193		1,5	
	540 i	M62 B44 (448S1-S2)	210/286	01.1997	08.1998	RFC 58 LZ2E	A10	B31	0,9	F54
	540 i	M62 B44 (448S1-S2)	210/286	09.1998	05.2004	RFC 58 LZP4	A193		1,5	
5 (E60)	NEW 520 i	N46 B20 B	115/156	04.2006	12.2009	RFN 58 LZDPE5	A539		1,1	
	520 i	M54 B22 (226S1)	125/170	07.2003	03.2010	RFC 58 LZP4	A193		1,5	
	523 i	N52 B25 A	130/177	07.2005	03.2010	RFC 58 HZEDP5	A191		1,1	
	523 i	N52 B25 A	140/190	01.2007	03.2010	RFC 58 HZEDP5	A191		1,1	
	525 i	M54 B25 (256S5)	141/192	09.2003	03.2010	RFC 58 LZP4	A193		1,5	
	525 i, xi	N52 B25 A	160/218	07.2005	03.2010	RFC 58 HZEDP5	A191		1,1	
	530 i	M54 B30 (306S3)	170/231	07.2003	03.2010	RFC 58 LZP4	A193		1,5	
	530 i, xi	N52 B30 A	190/258	07.2005	03.2010	RFC 58 HZEDP5	A191		1,1	
	NEW 535 i	N54 B30 A	225/306	09.2005	02.2010	RFN 58 LZDPE5	A539		1,1	
	NEW 540 i	N62 B40 A	225/306	09.2005	02.2010	RFN 58 LZDPE5	A539		1,1	
	545 i	N62 B44 A	245/333	09.2003	03.2010	RFC 58 LZP4	A193		1,5	
	NEW 550 i	N62 B48 A-B48 B	270/367	07.2005	02.2010	RFN 58 LZDPE5	A539		1,1	
5 Touring (E61)	520 i	M54 226S1	125/170	06.2004		RFC 58 LZP4	A193		1,5	
	523 i	N52 B25 A-B25 B-B25 BE	130/177	07.2005	12.2010	RFC 58 HZEDP5	A191		1,1	
	523 i	N52 B25 A	140/190	01.2007		RFC 58 HZEDP5	A191		1,1	
	525 i	M54 B25 (256S5)	141/192	06.2004	12.2010	RFC 58 LZP4	A193		1,5	
	525 i	N52 B25 A	160/218	07.2005	12.2010	RFC 58 HZEDP5	A191		1,1	

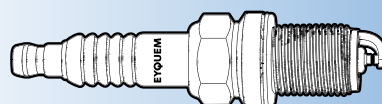

(1) Available until end of stock

- (a) 30 000 km
- (b) 60 000 km
- (c) Grey sticker on ignition coil
- (d) Green sticker on ignition coil

- (e) Hex 21 mm
- (f) Hex 16 mm
- (g) Recommended for cold weather



KW/HP



Box
10

Blister
4



F3-D1

BMW

	525 xi	N52 B25 A	160/218	07.2005	12.2010	RFC 58 HZEDP5	A191		1,1	
	530 i, xi	N52 B30 A	190/258	07.2005	12.2010	RFC 58 HZEDP5	A191		1,1	
	545 i	N62 B44 A	245/333	06.2004	12.2010	RFC 58 LZP4	A193		1,5	
	NEW 550 i	N62 B48 A-B48 B	270/367	07.2005	08.2010	RFN 58 LZDPE5	A539		1,1	
5 Gran Turismo (F07)	NEW 528 i	N20 B20 A	180/245	01.2013		RXN 72 HSDPFT	A540		0,8	
	NEW 550 i	N63 B44 B	330/449	01.2012		RXN 72 HSDPFT	A540		0,8	
	NEW 550 i xDrive	N63 B44 B	330/449	04.2011		RXN 72 HSDPFT	A540		0,8	
5 (F10)	NEW 520 i	N20 B20 A	120/163	10.2010		RXN 72 HSDPFT	A540		0,8	
	NEW 520 i	N20 B16 A	125/170	07.2013		RXN 72 HSDPFT	A540		0,8	
	NEW 520 i	N20 B20 A-B20 B	135/184	10.2010		RXN 72 HSDPFT	A540		0,8	
	NEW 528 i, xDrive	N20 B20 A	180/245	10.2010		RXN 72 HSDPFT	A540		0,8	
	NEW 550 i, xDrive	N63 B44 B	330/449	01.2013		RXN 72 HSDPFT	A540		0,8	
5 Touring (F11)	NEW 520 i	N20 B20 A-B20 B	135/184	10.2010		RXN 72 HSDPFT	A540		0,8	
	NEW 528 i, xDrive	N20 B20 A	180/245	03.2011		RXN 72 HSDPFT	A540		0,8	
	NEW 550 i	N63 B44 B	330/449	08.2012		RXN 72 HSDPFT	A540		0,8	
5 (G30, F90)	NEW 530 e iPerformance	B48 B20 B	135/184	03.2017		RXN 72 HSIPFSO	A550		0,75	
	NEW 530 e iPerformance	B48 B20 B	185/252	03.2017		RXN 72 HSIPFSO	A550		0,75	
	NEW 530 i	B48 B20 B/B46 B20 B	185/252	09.2016		RXN 72 HSIPFSO	A550		0,75	
	NEW 530 i xDrive	B48 B20 B/B46 B20 B	185/252	09.2016		RXN 72 HSIPFSO	A550		0,75	
	NEW 540 i	B58 B30 A	250/340	09.2016		RXN 72 HSIPFSO	A550		0,75	
	NEW 540 i	B58 B30 A	265/360	09.2016		RXN 72 HSIPFSO	A550		0,75	
	NEW 540 i xDrive	B58 B30 A	250/340	09.2016		RXN 72 HSIPFSO	A550		0,75	
	NEW 540 i xDrive	B58 B30 A	265/360	09.2016		RXN 72 HSIPFSO	A550		0,75	
6 (E24)	628 CSi	M30 B28	135/184	09.1979	08.1987	C 52 LS	A1	B1	0,7	L65
	630 CS	M30 B30	135-136/184-185	04.1976	08.1979	C 52 LS	A1	B1	0,7	L65
	633 CSi	M30 B32	145/197	10.1975	12.1981	C 52 LS	A1	B1	0,7	L65
	633 CSi	M30 B32	147/200	09.1979	04.1982	C 52 LS	A1	B1	0,7	L65
	635 CSi	M30 B34 (346KA)	136/185	12.1977	05.1987	C 52 LS	A1	B1	0,7	L65
	635 CSi	M30 B34 (346KA)	136/185	06.1987	04.1989	RC 52 LZE	A67		0,75	L65
	635 CSi	M30 B35	141/192	12.1977	05.1987	C 52 LS	A1	B1	0,7	L65
	635 CSi	M30 B35	141/192	06.1987	09.1990	RC 52 LZE	A67		0,75	L65
	635 CSi	M30 B35	150/204	06.1978	05.1987	C 52 LS	A1	B1	0,7	L65
	635 CSi	M30 B34 (346KB)	155/211	08.1987	05.1989	RC 52 LZE	A67		0,75	L65
	635 CSi	M30 B35	160/218	06.1978	05.1987	C 52 LS	A1	B1	0,7	L65
	635 CSi	M30 B35	160/218	06.1987	08.1988	RC 52 LZE	A67		0,75	L65
6 (E63)	630 i	N52 B30 A/N52 B30	190/258	09.2004	07.2010	RFC 58 HZEDP5	A191		1,1	
	645 Ci	N62 B44 A	245/333	01.2004	08.2005	RFC 58 LZP4	A193		1,5	
	NEW 650 i	N62 B48 B	270/367	07.2005	07.2010	RFN 58 LZDPE5	A539		1,1	
6 Cabriolet (E64)	630 i	N52 B30 A/N52 B30	190/258	09.2004	07.2010	RFC 58 HZEDP5	A191		1,1	
	645 Ci	N62 B44 A	245/333	04.2004	08.2005	RFC 58 LZP4	A193		1,5	
	NEW 650 i	N62 B48 B	270/367	07.2005	07.2010	RFN 58 LZDPE5	A539		1,1	
6 Cabriolet (F12)	NEW 650 i	N63 B44 A- B44 B	330/449	10.2011		RXN 72 HSDPFT	A540		0,8	
	NEW 650 i xDrive	N63 B44 A- B44 B	330/449	11.2011		RXN 72 HSDPFT	A540		0,8	
6 Coupé (F13)	NEW 650 i	N63 B44 B	330/449	10.2011		RXN 72 HSDPFT	A540		0,8	
	NEW 650 i xDrive	N63 B44 B	330/449	11.2011		RXN 72 HSDPFT	A540		0,8	
6 Gran Coupé (F06)	NEW 650 i, xDrive	N63 B44 B	330/449	11.2011		RXN 72 HSDPFT	A540		0,8	
7 (E23)	728	M30 B28	125/170	05.1977	08.1979	C 62 LS	A4	B5	0,7	L65
	728 i	M30 B28	135/184	07.1978	08.1986	C 52 LS	A1	B1	0,7	L65
	730	M30 B30	135/184	05.1977	08.1979	C 52 LS	A1	B1	0,7	L65
	732 i	M30 B32	145/197	05.1977	08.1986	C 52 LS	A1	B1	0,7	L65
	733 i	M30 B32	145/197	05.1977	08.1986	C 52 LS	A1	B1	0,7	L65
	735 i	M30 B34 (346KA)	136/185	01.1985	08.1986	RC 52 LZE	A67		0,7	L65
	735 i	M30 B35 (Motronic)	141/192	04.1985	08.1986	RC 52 LZE	A67		0,7	L65
	735 i	M30 B34 (346EC)	160/218	06.1982	06.1986	C 52 LS	A1	B1	0,7	L65
	735 i	M30 B35 (Motronic 9.3:1/10:1)	160/218	09.1979	08.1986	C 52 LS	A1	B1	0,7	L65
	735 i V8 32V	M62 B35 Cat	173/235	01.1996		RFC 58 LZ2E	A10	B31	0,9	F54
	745 i	M30 B35 (326TA)	185/252	04.1980	04.1983	C 52 LS	A1	B1	0,7	L65
	745 i	M30 B35	185/252	05.1983	08.1986	C 52 LS	A1	B1	0,7	L65
7 (E32)	730 i,iL	M30 B30 (306KA)	138/188	12.1986	09.1994	RC 52 LZE	A67		0,75	L65
	730 i,iL	M30 B30 (306EA)	145/197	12.1986	03.1994	RC 52 LZE	A67		0,75	L65
	730 i,iL V8	M60 B30 (308S1)	160/218	04.1992	09.1994	RFC 58 LZ2E	A10	B31	0,9	F54
	735 i,iL	M30 B35 (346KB)	155/211	09.1986	09.1992	RC 52 LZE	A67		0,75	L65
	735 i,iL	M30 B35 (Motronic,9.2:1)	162/220	09.1986	12.1987	RC 52 LZE	A67		0,75	L65

(1) Available until end of stock

(a) 30 000 km

(b) 60 000 km

(c) Grey sticker on ignition coil

(d) Green sticker on ignition coil

(e) Hex 21 mm

(f) Hex 16 mm

(g) Recommended for cold weather



EYQUEM



Box 10
Blister 4



F3→1

BMW										
	740 i,iL V8	M60 B40 (408S1)	210/286	04.1992	09.1994	RFC 58 LZ2E	A10	B31	0,9	F54
	750 i,iL V12	M70 B50 (5012A)	220/300	09.1987	10.1994	RFC 52 LZ2E	A102		0,75	F54
7 (E38)	728 i,iL	M52 B28 (286S1-S2)	142/193	08.1995	11.2001	RFC 58 LZ2E	A10	B31	0,9	F54
	730 i,iL	M60 B30 (308S1)	155/211	10.1994	08.1998	RFC 58 LZ2E	A10	B31	0,9	F54
	730 i,iL	M60 B30 (308S1)	160/218	10.1994	08.1998	RFC 58 LZ2E	A10	B31	0,9	F54
	735 i,iL	M62 B35 (358S1)	173/235	01.1996	08.1998	RFC 58 LZ2E	A10	B31	0,9	F54
	735 i,iL	M62 B35 (358S1)	173/235	09.1998	12.1998	RFC 58 LZP4	A193		1,5	
	740 i,iL	M60 B40 (408S1)	210/286	10.1994	08.1998	RFC 58 LZ2E	A10	B31	0,9	F54
	740 i,iL	M62 B44 (448S1-S2)	210/286	01.1996	08.1998	RFC 58 LZ2E	A10	B31	0,9	F54
	740 i,iL	M62 B44 (448S1-S2)	210/286	09.1998	11.2001	RFC 58 LZP4	A193		1,5	
	750 i,iL	M73 B54 (54121-54122)	240/326	12.1994	11.2001	RFC 58 LZP4	A193		1,5	
7 (E65, E66, E67)	730 i,Li	M54 B30 (306S3)	170/231	03.2003	07.2008	RFC 58 LZP4	A193		1,5	
	730 i,Li	N52 B30 A/N52 B30	190/258	03.2005	07.2008	RFC 58 HZEDP5	A191		1,1	
	735 i,Li	N62 B36 A	200/272	11.2001	02.2005	RFC 58 LZP4	A193		1,5	
	NEW 740 i,Li	N62 B40 A	225/306	07.2005	07.2008	RFN 58 LZDPE5	A539		1,1	
	745 i,Li	N62 B44 A	245/333	11.2001	07.2008	RFC 58 LZP4	A193		1,5	
	NEW 750 i,Li	N62 B48 B	270/367	07.2005	07.2008	RFN 58 LZDPE5	A539		1,1	
7 (E65, E66)	760 i,Li	N73 B60	327/445	01.2003	07.2008	RFC 58 LZP4	A193		1,5	
7 (F01, F02, F03, F04)	730 i,Li	N52 B30A/N52 B30 BF	190/258	06.2008	12.2009	RFC 58 HZEDP5	A191		1,1	
	NEW 750 i,xDrive	N63 B44 B	330/449	10.2012	05.2015	RXN 72 HSDPFT	A540		0,8	
7 (G11, G12)	NEW 730 i, Li	B48 B20 B	190/258	02.2016		RXN 72 HSIPFSO	A550		0,75	
	NEW 730 e, Le	B48 B20 B	190/258	04.2016		RXN 72 HSIPFSO	A550		0,75	
	NEW 740 e, Le	B48 B20 B	190/258	04.2016		RXN 72 HSIPFSO	A550		0,75	
	NEW 740 e, Le	B48 B20 B	240/326	04.2016		RXN 72 HSIPFSO	A550		0,75	
	NEW 740 e, Le xDrive	B48 B20 B	190/258	04.2016		RXN 72 HSIPFSO	A550		0,75	
	NEW 740 e, Le xDrive	B48 B20 B	240/326	04.2016		RXN 72 HSIPFSO	A550		0,75	
	NEW 740 i, Li	B58 B30 A	240/326	04.2016		RXN 72 HSIPFSO	A550		0,75	
	NEW 740 i, Li xDrive	B58 B30 A	240/326	04.2016		RXN 72 HSIPFSO	A550		0,75	
8 (E31)	840 i	M60 B40 (408S1)	210/286	03.1993	02.1996	RFC 58 LZ2E	A10	B31	0,9	F54
	840 Ci	M62 B44 (448S1)	210/286	01.1996	12.1999	RFC 58 LZ2E	A10	B31	0,9	F54
	840 Ci	M62 B44 (448S1)	210/286	01.1996	12.1999	RFC 58 LZP4	A193		1,5	
	850 i,Ci	M70 B50 (5012A)	220/300	04.1990	10.1994	RFC 52 LZ2E	A102		0,75	F54
	850 Ci	M73 B54 (54121)	240/326	09.1994	12.1999	RFC 58 LZP4	A193		1,5	
	850 CSI	S70 B56 (56121)	280/381	04.1993	12.1996	RFC 52 LZ2E	A102		0,75	F54
X1 (E84)	NEW sDrive 16 i	N20 B16 A	105/143	03.2013	06.2015	RXN 72 HSDPFT	A540		0,8	
	NEW sDrive 18 i	N46 B20 B	100/136	03.2009	06.2015	RFN 58 LZDPE5	A539		1,1	
	NEW sDrive 18 i	N46 B20 B	110/150	01.2010	06.2015	RFN 58 LZDPE5	A539		1,1	
	NEW sDrive 20 i	N20 B20 A	135/184	09.2011	06.2015	RXN 72 HSDPFT	A540		0,8	
	NEW xDrive 20 i	N20 B20 A	135/184	09.2011	06.2015	RXN 72 HSDPFT	A540		0,8	
	xDrive 25 i	N52 B30 A	160/218	01.2010	06.2015	RFC 58 HZEDP5	A191		1,1	
	NEW xDrive 28 i	N20 B20 A	180/245	04.2011	06.2015	RXN 72 HSDPFT	A540		0,8	
	xDrive 28 i	N52 B30 A	190/258	10.2009	06.2015	RFC 58 HZEDP5	A191		1,1	
X1 (F48)	NEW sDrive 18 i	B38 A15 A	100/136	11.2014	05.2017	RXN 72 HSIPFSO	A550		0,75	
	NEW sDrive 20 i	B48 A20 A	141/192	09.2015		RXN 72 HSIPFSO	A550		0,75	
	NEW xDrive 20 i	B48 A20 A/B48 A20 B	141/192	09.2015		RXN 72 HSIPFSO	A550		0,75	
	NEW xDrive 25 i	B48 A20 B	170/231	09.2015		RXN 72 HSIPFSO	A550		0,75	
X3 (E83)	NEW 2.0 i	N46 B20 B	110/150	07.2005	08.2008	RFN 58 LZDPE5	A539		1,1	
	NEW xDrive 20 i	N46 B20 B	110/150	09.2008	08.2011	RFN 58 LZDPE5	A539		1,1	
	2.5 i	M54 B25 (256S5)	141/192	01.2004	08.2006	RFC 58 LZP4	A193		1,5	
	2.5 si	N52 B25 A	160/218	09.2006	08.2008	RFC 58 HZEDP5	A191		1,1	
	xDrive 25 i	N52 B25 A	160/218	09.2008	12.2011	RFC 58 HZEDP5	A191		1,1	
	3.0 i xDrive	M54 B30 (306S3)	170/231	01.2004	08.2006	RFC 58 LZP4	A193		1,5	
	3.0 si	N52 B30 A	200/272	09.2006	08.2008	RFC 58 HZEDP5	A191		1,1	
	xDrive 30 i	N52 B30 A	200/272	09.2008	12.2011	RFC 58 HZEDP5	A191		1,1	
X3 (F25)	NEW sDrive 20 i	N20 B20 A	135/184	02.2014		RXN 72 HSDPFT	A540		0,8	
	NEW xDrive 20 i	N20 B20 A	135/184	09.2011		RXN 72 HSDPFT	A540		0,8	
	NEW xDrive 28 i	N20 B20 A	180/245	08.2011		RXN 72 HSDPFT	A540		0,8	
	xDrive 28 i	N52 B30 A	190/258	04.2011		RFC 58 HZEDP5	A191		1,1	
X4 (F26)	NEW xDrive 20 i	N20 B20 A	135/184	03.2015		RXN 72 HSDPFT	A540		0,8	
	NEW xDrive 28 i	N20 B20 A	180/245	03.2015		RXN 72 HSDPFT	A540		0,8	
X5 (E53)	3.0 i	M54 B30 (306S3)	163/222	05.2000	12.2006	RFC 58 LZP4	A193		1,5	
	3.0 i	M54 B30 (306S3)	170/231	05.2000	12.2006	RFC 58 LZP4	A193		1,5	
	4.4 i	M62 B44 (448S2)	210/286	05.2000	12.2003	RFC 58 LZP4	A193		1,5	
	4.4 i	N62 B44 A	235/320	12.2003	09.2006	RFC 58 LZP4	A193		1,5	
	4.6 is	M62 B46 (468S1)	255/347	02.2002	12.2003	RFC 58 LZP4	A193		1,5	

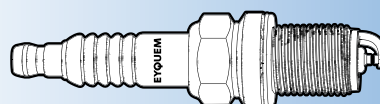

(1) Available until end of stock

- (a) 30 000 km
- (b) 60 000 km
- (c) Grey sticker on ignition coil
- (d) Green sticker on ignition coil

- (e) Hex 21 mm
- (f) Hex 16 mm
- (g) Recommended for cold weather



KW/HP



Box
10

Blister
4



F3→1

BMW

	NEW	4.8 is	N62 B48 A	265/360	04.2004	09.2006	RFN 58 LZDPE5	A539		1,1	
X5 (E70)		3.0 si	N52 B30 A/N52 B30	200/272	02.2007	09.2008	RFC 58 HZEDP5	A191		1,1	
		xDrive 30 i	N52 B30 A	200/272	09.2008	03.2010	RFC 58 HZEDP5	A191		1,1	
	NEW	48 i xDrive	N62 B48 B	261/355	02.2007	09.2008	RFN 58 LZDPE5	A539		1,1	
	NEW	xDrive 48 i	N62 B48 B	261/355	09.2008	03.2010	RFN 58 LZDPE5	A539		1,1	
X5 (F15, F85)	NEW	xDrive 40e	N20 B20 A	180/245	09.2015		RXN 72 HSDPFT	A540		0,8	
	NEW	xDrive 40e	N20 B20 A	230/313	10.2015		RXN 72 HSDPFT	A540		0,8	
	NEW	xDrive 50 i	N63 B44 B	330/449	07.2013		RXN 72 HSDPFT	A540		0,8	
X6 (F16, F86)	NEW	xDrive 50 i	N63 B44 B	330/449	08.2014		RXN 72 HSDPFT	A540		0,8	
Z1		2.5	M20 B25 (256K1)	125/170	11.1988	06.1991	RC 52 LZ2E	A67		0,75	L65
Z3 (E36)		1.8 i	M43 B18 (184E2)	85/115	10.1995	10.1998	RFC 58 LZ2E	A10	B31	0,9	F54
		1.9 i	M43 B19 (194E1)	86/116	01.1999	01.2003	RFC 58 LZP4	A193		1,5	
		1.9 i	M43 B19 (194E1)	87/118	07.1998	01.2003	RFC 58 LZP4	A193		1,5	
		1.9 i	M44 B19 (194S1)	103/140	10.1995	03.1999	RFC 58 LZ2E	A10	B31	0,9	F54
		2.0 i	M52 B20 (206S4)	110/150	04.1999	01.2003	RFC 58 LZP4	A193		1,5	
		2.2 i	M54 B22 (226S1)	125/170	08.2000	01.2003	RFC 58 LZP4	A193		1,5	
		2.8 i	M52 B28 (286S1)	141/192	04.1997	08.1998	RFC 58 LZ2E	A10	B31	0,9	F54
		2.8 i	M52 B28 (286S1)	141/192	09.1998	06.2000	RFC 58 LZP4	A193		1,5	
		3.0 i	M54 B30 (306S3)	170/231	06.2000	01.2003	RFC 58 LZP4	A193		1,5	
	Z3 Coupé (E36)		2.8 i	M52 B28 (286S1)	141/192	07.1997	06.2000	RFC 58 LZP4	A193		1,5
Z4 (E85)	NEW	2.0 i	N46 B20 A-B20 B	110/150	03.2005	02.2009	RFN 58 LZDPE5	A539		1,1	
		2.2 i	M54 B22 (226S1)	125/170	10.2003	10.2005	RFC 58 LZP4	A193		1,5	
		2.5 i	M54 B25 (256S5)	141/192	02.2003	12.2005	RFC 58 LZP4	A193		1,5	
		2.5 i	N52 B25 A	130/177	09.2005	02.2009	RFC 58 HZEDP5	A191		1,1	
		2.5 si	N52 B25 A	160/218	09.2005	02.2009	RFC 58 HZEDP5	A191		1,1	
		3.0 i	M54 B30 (306S3)	170/231	02.2003	10.2005	RFC 58 LZP4	A193		1,5	
		3.0 si	N52 B30 A	195/265	01.2006	12.2008	RFC 58 HZEDP5	A191		1,1	
	Z4 Coupe (E86)		3.0 si	N52 B30 A	195/265	03.2006	01.2009	RFC 58 HZEDP5	A191		1,1
Z4 Roadster (E89)	NEW	sDrive 18 i	N20 B20 A	115/156	04.2013		RXN 72 HSDPFT	A540		0,8	
	NEW	sDrive 20 i	N20 B20 A	135/184	09.2011		RXN 72 HSDPFT	A540		0,8	
		sDrive 23 i	N52 B25 A	150/204	05.2009		RFC 58 HZEDP5	A191		1,1	
	NEW	sDrive 28 i	N20 B20 A	180/245	09.2011		RXN 72 HSDPFT	A540		0,8	
		sDrive 30 i	N52 B30 A	190/258	05.2009		RFC 58 HZEDP5	A191		1,1	
Z8 (E52)		4.9	S62 B50 (508S1)	294/400	06.2000	06.2003	RFC 58 LZP4	A193		1,5	

BRISTOL

412		5.9 V8			09.1977	12.1982	RC 32 LS	A49	B19	0,9	L3
603		5.9 V8 E, S			01.1977	12.1983	RC 32 LS	A49	B19	0,9	L3
BEAUFIGHTER		5.9 V8 Turbo			01.1980	12.1989	RC 32 LS	A49	B19	0,9	L3
BLENNHEIM		5.9 i V8	170/231		03.1994		RC 32 LS	A49	B19	0,9	L3
BRIGAND		5.9 V8 Turbo			01.1983		RC 32 LS	A49	B19	0,9	L3
BRITANNIA		5.9 V8			10.1982	12.1989	RC 32 LS	A49	B19	0,9	L3

BUICK

SKYHAWK		1.8 i Turbo	(J)		01.1984	12.1986	RC 62 LS	A6	B17	0,8	L65
SKYLARK		2.3 i Grand Sport		90/122	09.1991	08.1994	RFC 42 LS5	A83		1,1	F54-5

CATERHAM

21		1.6 i 16V	16K series	86/117	10.1994		RFC 58 LS	A18		0,7	F54
		1.6 i 16V Superlight / Sport	16K series	103/140			RFC 82 LS	A76		0,7	F86
SUPER SEVEN		1.4 i 16V	K 16 series [DOHC]	76/103	01.1992		RFC 52 LS	A3	B16	0,8	F54
		1.4 i 16V (6 vitesses, 6 Speed)	K 16 series [DOHC]	96/131	01.1994		RFN 58 LZ (b)	A7	B28	0,8	F54
		1.4 i 16V (6 vitesses, 6 Speed)	K 16 series [DOHC]	96/131	01.1994		RFN 58 LZ3A (g)	A515		0,8	
	1.6		BDR	125/170	01.1985	12.1990	RC 82 L	A94		0,6	
	1.6 GT		(S)		01.1981	12.1991	RC 72 LS	A32	B26	0,8	L87
	1.6 GT Sprint, Twin Cam		(T)		01.1981	12.1991	RC 82 LS	A78		0,6	L87
	1.6 i 16V		16K series	86/117	10.1994		RFC 58 LS	A18		0,7	F54
	1.6 i 16V Superlight / Sport		16K series	103/140			RFC 82 LS	A76		0,7	F86
	1.7 Super Sprint			99/135	01.1985	12.1990	RC 82 L	A94		0,6	
	2.0 i 16V HPC		Mot. Vauxhall	121-140/165-190	07.1991		RFC 82 LS	A76		0,7	F86

(1) Available until end of stock

(a) 30 000 km

(b) 60 000 km

(c) Grey sticker on ignition coil

(d) Green sticker on ignition coil

(e) Hex 21 mm

(f) Hex 16 mm

(g) Recommended for cold weather



EYQUEM



Box 10
Blister 4



F3-1

CHEVROLET

AVEO	1.2	B12D1	62/84	04.2008		RZC 62 LS	A524	0,8	
	1.4	F 14 D4	74/101	04.2008	12.2011	RFC 58 LZ5E	A75	1,1	F54-5
AVEO (T250, T255)	NEW 1.4	A 14 XER/ F14D4/ LDT	74/101	04.2008		RFN 42 LZG	A532	0,9	
AVEO (T300)	NEW 1.2	A 12 XEL	51/69	03.2011		RFN 42 LZG	A532	0,9	
	NEW 1.2	A 12 XER	63/86	03.2011		RFN 42 LZG	A532	0,9	
	NEW 1.4	A 14 XER	74/101	03.2011		RFN 42 LZG	A532	0,9	
	NEW 1.6	F 16D4	85/115	03.2011		RFN 42 LZG	A532	0,9	
ASTRO VAN	4.3 i V6	L35	137/186	04.1995		RC 62 LJS	A68	0,8	J65
BERETTA	2.3 i 16V GTZ	(D) [DOHC]	130/177	09.1990		RFC 42 LS5	A83	1,1	F54-5
BLAZER	4.3 i V6	L35	137-142/186-193	03.1995		RC 62 LJS	A68	0,8	J65
CAPTIVA	2.4	Z 24 SED	100/136	06.2006		RFC 42 LZ2E	A5	B30	1,0 F54
CRUZE	1.6	F 16 D3	80/109	05.2009		RFC 52 LS5	A26	B24	0,7 F54-5
	1.6	F 16 D4	83/113	05.2009	10.2010	RFC 52 LS5	A26	B24	0,7 F54-5
	1.6	F 16 D4	91/124	05.2009	10.2010	RFC 52 LS5	A26	B24	0,7 F54-5
	1.8	F 18 D4	104/141	05.2009		RFC 52 LS5	A26	B24	0,7 F54-5
CORVETTE	5.7 i V8 32V ZR-1	LT5		06.1989	08.1995	RFC 58 LS	A18		0,9 F54
	5.7 i V8 ZR-1	L98		06.1989	08.1995	RFC 58 LS	A18		0,9 F54
KALOS	1.2	B 12 S1	53/72	03.2005		RC 52 LS5	A36	B38	1,1 L65-5
	1.4	F 14 S3	61/83	03.2005		RC 62 LS	A6	B17	0,8 L65
	1.4 16V	F 14 D3	69/94	03.2005		RFC 52 LS5	A26	B24	1,1 F54-5
LACETTI	1.4 16V	F 14 D3	70/95	03.2005		RFC 52 LS5	A26	B24	1,1 F54-5
	1.6	F 16 D3	80/109	03.2005		RFC 52 LS5	A26	B24	1,1 F54-5
MATIZ	0.8	F8CV	38/52	03.2005		RC 52 LS5	A36	B38	1,1 L65-5
	0.8 LPG	F8CV	38/52	03.2005		RC 62 LS	A6	B17	0,8 L65
	1.0	B10S1	47/64	03.2005	12.2010	RC 52 LS5	A36	B38	1,1 L65-5
	1.0	B10S1	49/67	03.2005	12.2010	RC 52 LS5	A36	B38	1,1 L65-5
NUBIRA	1.4	F 14 D3	69/94	01.2005		RFC 52 LS5	A26	B24	1,1 F54-5
	1.4	F 14 D3	70/95	01.2006		RFC 52 LS5	A26	B24	1,1 F54-5
	1.6	F 16 D3	80/109	03.2005		RFC 52 LS5	A26	B24	1,1 F54-5
SPARK	0.8	F8CV	37/50	05.2005		RC 62 LS	A6	B17	0,8 L65
	1.0 SX	B10S	46/63	05.2005	12.2010	RC 62 LS	A6	B17	0,8 L65
	1.0 SX	B10S1	49/67	05.2005	12.2010	RC 62 LS	A6	B17	0,8 L65
SPARK II	1.0	B10D1	51/69	03.2010		RZC 62 LS	A524		0,8
	1.2	B12D1	60/82	03.2010		RZC 62 LS	A524		0,8

CHRYSLER

CIRRUS	2.0 i 16V	ECB	96-98/131-133	01.1994		RFC 52 LS	A3	B16	0,8 F54
COUPE	2.2 L6 Turbo			01.1987	12.1990	RC 62 LS	A6	B17	0,8 L65
	2.5 L6 Turbo			01.1987	12.1990	RC 62 LS	A6	B17	0,8 L65
ES	2.2 i Turbo	EDR	105-109/143-148	01.1988		RC 32 LS	A49	B19	0,9 L3
GRAND VOYAGER	2.4 i 16V	EDZ	108/147	04.2001		RN 22 HJSE6	A180		1,3
GS	2.2 i Turbo	EDS	130/177	01.1988		RC 32 LS	A49	B19	0,9 L3
LE BARON	2.2 i Cabrio, GTS		72/98	01.1984	08.1995	RC 32 LS	A49	B19	0,9 L3
	2.2 i Turbo	EDG	109/148	01.1984	08.1995	RC 32 LS	A49	B19	0,9 L3
	2.2 i Turbo GTC Turbo		130/177	01.1984	09.1990	RC 32 LS	A49	B19	0,9 L3
	2.5 i Turbo	TCi	107/145	01.1986	08.1989	RC 32 LS	A49	B19	0,9 L3
	3.0 i V6	(3)	100/136	05.1989	08.1995	RC 32 LS5	A110		1,1
NEON	1.8 i 16V [PL]	EBD	86/117	02.1998		RFC 52 LS	A3	B16	0,8 F54
	2.0 16V		107/145	06.1994	08.1999	RFC 42 LS	A25		0,8 F54
	2.0 16V	420T	109/148	04.1996	08.1999	RFC 42 LS	A25		0,8 F54
	2.0 i 16V [PL]	(C) [DOHC]	98-109/133-148	01.1994		RFC 52 LS	A3	B16	0,8 F54
NEW YORKER	2.5 i	(K)	74/101	01.1985	12.1987	RC 30 LS	A109		0,9
PT CRUISER	2.0 i 16V			09.1999		RN 22 HJSE6	A180		1,3
SARATOGA	2.0 i 16V		96/131	05.1995		RFC 52 LS	A3	B16	0,8 F54
	2.5 i		72/98	09.1987		RC 52 LS5	A36	B38	1,1 L65-5
	3.0 i V6		104/141	09.1987		RC 52 LS5	A36	B38	1,1 L65-5
SEBRING	2.0 i 16V	[DOHC]	104/141	09.1994		RFC 42 LS5	A83		1,1 F54-5
	2.0 i 16V	EC4	104/141	06.2001		RN 22 HJSE6	A180		1,3
	2.5 i 24V		116/158	09.1994		RFC 42 LS5	A83		1,1 F54-5
STRATUS	2.0 i 16V [JA]	ECB	96-98/131-133	01.1994		RFC 52 LS	A3	B16	0,8 F54
	2.4 16 V		103/140	12.1995	04.2001	RFC 42 LS5	A83		1,1 F54-5
	2.4 16V		112/152	12.1995	04.2001	RFC 42 LS5	A83		1,1 F54-5
	2.5 i 24V [JA]	(H)	118/160	08.1995		RFC 42 LS5	A83		1,1 F54-5
STRATUS Cabriolet	2.5 LX	625H	120/163	04.1996	04.2001	RFN 58 LZDP5	A187		1,1



(1) Available until end of stock

(a) 30 000 km

(b) 60 000 km

(c) Grey sticker on ignition coil

(d) Green sticker on ignition coil

(e) Hex 21 mm

(f) Hex 16 mm

(g) Recommended for cold weather



KW/HP



Box
10

Blister
4



F3→1

CHRYSLER

TOWN & COUNTRY	2.2 i Turbo	(A)				RC 30 LS	A109		0,9	
	3.0 i V6	6G 72 [SOHC]	105/143	09.1989		RC 52 LS5	A36	B38	1,1	L65-5
	3.0 i V6	(S)		01.1990	12.1991	RC 32 LS5	A110		1,1	
VIPER	8.0		290/394	08.1992	12.1996	RFN 42 LZG5	A112		1,1	
	8.0	EPD	282/384	07.1998		RFN 42 LZG5	A112		1,1	
	8.0 Convertible		290/394	08.1992	12.1996	RFN 42 LZG5	A112		1,1	
	8.0 Convertible	EPD	282/384	07.1998		RFN 42 LZG5	A112		1,1	
VOYAGER	2.5 i	K00	72/98	08.1984	09.1995	RC 32 LS	A49	B19	0,75	L3
	2.5 i	K	74/101	08.1990	09.1995	RC 32 LS	A49	B19	0,75	L3
	2.5 i [ES]		72/98	09.1987	12.1995	RC 52 LS	A9	B20	0,9	L65
	3.0 i V6 [ES]	(A)	104/141	09.1987	12.1992	RC 32 LS5	A110		1,1	
VOYAGER II	2.0 i 16V [GS]		98/133	01.1996		RFC 52 LS	A3	B16	0,8	F54
	2.4 i 16V [GS]	(X) [DOHC]	110/150	10.1995	03.2001	RFC 42 LS5	A83		1,1	F54-5
VOYAGER III	2.4 i 16V	EDZ	108/147	04.2001		RN 22 HJSE6	A180		1,3	

CITROËN

2CV	0.6 2 CV, 4, 6, Charleston, Club, Cocorico, Spot, Voisin, Spécial, Spécial E		17-18-20-21/ 23-24-27-29			C 62	A20		0,6	
ACADIANE	0.6	M28 (AM2)	22/30	08.1978	10.1988	C 62	A20		0,6	
	0.6	M28 (AM2)	23/31	08.1978	10.1988	C 62	A20		0,6	
AK	350, 400, 0.6					C 62	A20		0,6	
AMI 6 (AM, AMB)	0,6	M4 (AM)	18/24	01.1963	05.1968	C 62	A20		0,6	
	0,6	M28 (AM2)	24/33	05.1968	07.1969	C 62	A20		0,6	
AMI 8 (AM3)	0,6	M28 (AM2)	24/33	07.1969	12.1977	C 62	A20		0,6	
AMI 10 Super (AM3)	1,0	G10	40/54	03.1973	12.1977	C 72 LS (1)	A30		0,6	L87
	1,0	G10	40/54	03.1973	12.1977	RC 72 LS	A32		0,6	L87
AX	10	CDZ (TU9M)	37/50	02.1987	12.1998	RFN 52 LZ	A27		0,9	F54
	10	CDY (TU9M)	33/44	07.1986	12.1998	RFN 52 LZ	A27		0,9	F54
	10, 1.0	TU9 [C1A - C1B -]	29-34/40-46	10.1986	06.1992	RFC 58 LZK (a)	A11	B29	0,9	F54
	10, 1.0 i	TU9M [CDY] [CDZ]	33-37/45-50	07.1992		RFC 42 LS	A25		0,8	F54
	10, 1.0 i	TU9M [CDY] [CDZ]	33-37/45-50	07.1992		RFN 52 LZ	A27		0,9	F54
	10 E	C3A	30/41	12.1986	12.1988	RFN 52 LZ	A27		0,9	F54
	1.0 Spot, X, Image	TU9M	37/50	07.1995		RFC 42 LZ2E	A5	B30	0,9	F54
	11	H1B/HDZ (TU1M)	44/60	09.1986	12.1997	RFN 52 LZ	A27		0,9	F54
	11	H1A - H1B	40/54	12.1986	04.1994	RFN 52 LZ	A27		0,9	F54
	14	K1F	49/67	06.1988	12.1989	RFN 52 LZ	A27		0,9	F54
	14	KAY (TU3CP)	44/60	12.1986	12.1988	RFN 52 LZ	A27		0,9	F54
	14	K1G	51/69	01.1989	12.1991	RFN 52 LZ	A27		0,9	F54
	1.1	TU1M	40/54	07.1995		RFC 42 LZ2E	A5	B30	0,9	F54
	1.1	TU1M [HDY]	40/54	10.1989		RFC 58 LZK (a)	A11	B29	0,9	F54
	1.1	TU1M [HDY]	40/54	10.1989		RFN 58 LZ (b)	A7	B28	0,9	F54
	1.1	TU1M [HDY]	40/54	10.1989		RFN 58 LZ3A (g)	A515		0,9	
	1.1 i	TU1M [HDY] [HDZ]	40-44/54-60	10.1989		RFC 58 LZK (a)	A11	B29	0,9	F54
	1.1 i	TU1M [HDY] [HDZ]	40-44/54-60	10.1989		RFN 58 LZ (b)	A7	B28	0,9	F54
	1.1 i	TU1M [HDY] [HDZ]	40-44/54-60	10.1989		RFN 58 LZ3A (g)	A515		0,9	
	11, 1.1	TU1 [H1A - H3A - H1B - H1C - HAZ]	40/54	10.1986		RFN 58 LZ (b)	A7	B28	0,9	F54
	11, 1.1	TU1 [H1A - H3A - H1B - H1C - HAZ]	40/54	10.1986		RFC 58 LZK (a)	A11	B29	0,9	F54
	11, 1.1	TU1 [H1A - H3A - H1B - H1C - HAZ]	40/54	10.1986		RFN 58 LZ3A (g)	A515		0,9	
	11 KAT	HAZ (TU1CP)	40/54	09.1988	12.1989	RFN 52 LZ	A27		0,9	F54
	1.3 Sport	TU2.4	70/95	04.1987	12.1988	FC 82 LS 3	A84		1,05	
	1.4	TU3TR [K3A]		10.1986		RFC 58 LZK (a)	A11	B29	0,9	F54
	1.4	TU3.2TR [K3B-K5A]								
	1.4	TU3TR [K3A]		10.1986		RFN 58 LZ (b)	A7	B28	0,9	F54
	1.4	TU3.2TR [K3B-K5A]								
	1.4	TU3TR [K3A]	62/84	10.1986		RFN 58 LZ3A (g)	A515		0,9	
	1.4	TU3.2TR [K3B-K5A]								
	1.4 GT, GTS, TE, Volcane	TU3-N [K1B] - TU3 S [K2A-K2B]	44-63/60-85	10.1987	12.1992	RFC 58 LZK (a)	A11	B29	0,9	F54
	1.4 GT, GTS, TE, Volcane	TU3-N [K1B] - TU3 S [K2A-K2B]	44-63/60-85	10.1987	12.1992	RFN 58 LZ (b)	A7	B28	0,9	F54
	1.4 GT, GTS, TE, Volcane	TU3-N [K1B] - TU3 S [K2A-K2B]	44-63/60-85	10.1987	12.1992	RFN 58 LZ3A (g)	A515		0,9	

(1) Available until end of stock

(a) 30 000 km

(b) 60 000 km

(c) Grey sticker on ignition coil

(d) Green sticker on ignition coil

(e) Hex 21 mm

(f) Hex 16 mm

(g) Recommended for cold weather



EYQUEM



Box 10
Blister 4



F3 → 1

CITROËN

	1.4 GTi	KFZ (TU3FJ2)	69/94	06.1991	12.1996	RFN 58 LZ (b)	A7	B28	0,9	F54
	1.4 GTi	KFZ (TU3FJ2)	69/94	06.1991	12.1996	RFN 58 LZ3A (g)	A515		0,9	
	1.4 GTi	KFZ (TU3FJ2)	74/101	06.1991	12.1992	RFN 58 LZ	A7	B28	0,9	F54
	1.4 GTi	KFZ (TU3FJ2)	74/101	06.1991	12.1992	RFN 58 LZ3A (g)	A515		0,9	
	1.4 GTi	KFY (TU3FJ2)	66/90	08.1991	12.1996	RFN 58 LZ (b)	A7	B28	0,9	F54
	1.4 GTi	KFY (TU3FJ2)	66/90	08.1991	12.1996	RFN 58 LZ3A (g)	A515		0,9	
	1.4 i GTi	TU3J2 [K6B - KFY - KFZ]	66-70-74/90-95-101	05.1991		RFN 58 LZ (b)	A7	B28	0,9	F54
	1.4 i GTi	TU3J2 [K6B - KFY - KFZ]	66-70-74/90-95-101	05.1991		RFN 58 LZ3A (g)	A515		0,9	
	1.4 i	TU3M [KDX - KDY - KDZ]	55-58/75-79	06.1988	04.1997	RFC 58 LZK (a)	A11	B29	0,9	F54
	1.4 i	TU3M [KDX - KDY - KDZ]	55-58/75-79	06.1988	04.1997	RFN 58 LZ (b)	A7	B28	0,9	F54
	1.4 i	TU3M [KDX - KDY - KDZ]	55-58/75-79	06.1988	04.1997	RFN 58 LZ3A (g)	A515		0,9	
	14, 4x4	KDX (TU3M/Z)/KDY (TU3FM)/ KDY (TU3M)/KDZ (TU3M/Z)	55/75	07.1995	04.1997	RFC 58 LZ2	A54		1	F54
	14,,4x4	KDX (TU3M/Z)/KDY (TU3FM)/ KDY (TU3M)/KDZ (TU3M/Z)	55/75	04.1987	06.1995	RFN 52 LZ	A27		0,9	F54
AXEL	11	G11/631	42/57	01.1984	03.1991	C 62 LJS	A19	B2	0,6	J65
	11		45/61	01.1984	03.1991	C 62 LJS	A19	B2	0,6	J65
	11, 12, 1.1, R, RS, TRS, Entrepri			07.1984		C 62 LJS	A19	B2	0,6	J65
BERLINGO	1.1 i	TU1JP-L4 [HFZ]	44/60	06.2000		RFC 58 LZK (a)	A11	B29	0,9	F54
	1.1 i	TU1JP-L4 [HFZ]	44/60	06.2000		RFN 58 LZ (b)	A7	B28	0,9	F54
	1.1 i	TU1JP-L4 [HFZ]	44/60	06.2000		RFN 58 LZ3A (g)	A515		0,9	
	1.1 i	HDZ (TU1M)/HFX (TU1JP)	44/60	07.1996		RFC 58 LZ2	A54		1	F54
	1.4 Bivalent	KFW (TU3JP)	48/65	11.2002		RFC 58 LZ2	A54		1	F54
	1.4	KFW (TU3JP)	53/72	11.2002	10.2005	RFC 58 LZ2	A54		1	F54
	1.4 i	KFW (TU3JP)/KFX (TU3JP)	55/75	07.1996	10.2008	RFC 58 LZ2	A54		1	F54
	1.4 i X, SX, Familiale, type 600/800	TU3JP [KFX]	55/75	07.1996	10.2008	RFC 58 LZ2	A54		1	F54
	1.6 i 16V	TU5 JP4-L4 [NFU] [DOHC]	80/109	09.2000		RFN 58 HZ	A158		0,9	
	1.6 i 16V	TU5 JP4-L4 [NFU] [DOHC]	80/109	09.2000		RFN 58 HZ3A (g)	A516		0,9	
	1.6 i 16V	TU5 JP [NFU]	81/110	11.2002		RFN 58 HZ	A158		0,9	
	1.6 i 16V	TU5 JP [NFU]	81/110	11.2002		RFN 58 HZ3A (g)	A516		0,9	
	1.6	TU5 JP4 B (NFR)	66/90	04.2008		RFN 58 HZ	A158		0,9	
	1.6	TU5 JP4 B (NFR)	66/90	04.2008		RFN 58 HZ3A (g)	A516		0,9	
	1.6 VTi 120	5FS (EP6C)	88/120	11.2009		RXN 62 HSDP	A525		0,7	
	1.6 VTi 95	5FK (EP6CB)	72/98	07.2010		RXN 62 HSDP	A525		0,7	
	1.8 i	XU7 JB [LFX]	66/90	03.1997		RFC 58 LZK (a)	A11	B29	0,9	F54
	1.8 i	XU7 JB [LFX]	66/90	03.1997		RFN 58 LZ (b)	A7	B28	0,9	F54
	1.8 i	XU7 JB [LFX]	66/90	03.1997		RFN 58 LZ3A (g)	A515		0,9	
	1.8 i, 4WD	LFX (XU7JB)	66/90	04.1997		RFC 58 LZ2	A54		1	F54
	475/600, 1.1 i Familiale	TU1M+ [HDZ]	44/60	07.1996		RFC 58 LZ2	A54		1	F54
	600, 1.4 Familiale	TU3.2 [K5A]	52/71	10.1996		RFC 58 LZK (a)	A11	B29	0,9	F54
	600, 1.4 Familiale	TU3.2 [K5A]	52/71	10.1996		RFN 58 LZ (b)	A7	B28	0,9	F54
	600, 1.4 Familiale	TU3.2 [K5A]	52/71	10.1996		RFN 58 LZ3A (g)	A515		0,9	
BERLINGO Multispace	1.1 i	TU1M+ [HDY] [HDZ] - TU1JP-L4 [HFZ]	40-44/54-60	07.1996		RFC 58 LZ2	A54		1	F54
	1.4 bivalent	KFW (TU3JP)	48/65	11.2002		RFC 58 LZ2	A54		1	F54
	1.4 i bivalent	KFW (TU3JP)	55/75	04.2003		RFC 58 LZ2	A54		1	F54
	1.4	TU3.2 [K2C-K2D-K5A]	55/75	07.1996		RFC 58 LZK (a)	A11	B29	0,9	F54
	1.4	TU3.2 [K2C-K2D-K5A]	55/75	07.1996		RFN 58 LZ (b)	A7	B28	0,9	F54
	1.4	TU3.2 [K2C-K2D-K5A]	55/75	07.1996		RFN 58 LZ3A (g)	A515		0,9	
	1.4 i X, SX, Le Grand Bleu	TU3JP [K6C - KFX - K6C - KFX]	55/75	07.1996		RFC 58 LZ2	A54		1	F54
	1.6 i 16V	TU5 JP4-L4 [NFU] [DOHC]	80/109	09.2000		RFN 58 HZ	A158		0,9	
	1.6 i 16V	TU5 JP4-L4 [NFU] [DOHC]	80/109	09.2000		RFN 58 HZ3A (g)	A516		0,9	
	1.8 i SX	XU7 JB [LFX]	66/90	05.1997		RFC 58 LZ2	A54		1	F54
BERLINGO (B9) NEW	1.2 PureTech 110		81/110	02.2016		RXN 72 HSI PFS	A541		0,75	
BX	1.9 i 16V GTi 16S	XU9 J4-Z [DFW]	109/148	03.1988	02.1993	RFC 58 LS3	A16	B33	1,2	
	1.9 i 16V GTi 16S	XU9 J4 [D6C]	118/160	07.1987	12.1988	RFC 62 LS3	A56		1,2	
	11, 1.1	TU1 [H1A - H1B - H1C - H3A - HAZ]	40/54	06.1987	09.1993	RFC 58 LZK (a)	A11	B29	0,9	F54
	11, 1.1	XW7B2 [109LA]	42/57	10.1982	04.1988	C 62 LJS	A19	B2	0,9	J65
	14, 1.4 Calanque, Olympique	TU3A [K1C-K1D-K1F-K1]		06.1987	09.1993	RFC 58 LZK (a)	A11	B29	0,9	F54
	14, 1.4 E, RE	XY6 [150F]	49/67	07.1988	06.1989	RFC 58 LZK (a)	A11	B29	0,9	F54
	14, 1.4 E, RE, TRE	XY6C - XY6D	46/63	05.1988	09.1993	RFC 58 LZK (a)	A11	B29	0,9	F54
	14, 1.4 E, RE, TRE	XY6C - XY6D	46/63	10.1982	04.1988	C 62 LJS	A19	B2	0,9	J65
	14, 1.4 E, RE, TRE, TE, TGE, Entrepri	TU3A (K1C-K1D-K1F-K1)		06.1987	09.1993	RFC 58 LZK (a)	A11	B29	0,9	F54
	14, 1.4 E, RE, TRE, TE, TGE, Entrepri	TU3.2-K [K2D]	55/75	07.1986	09.1993	RFC 58 LZK (a)	A11	B29	0,9	F54



(1) Available until end of stock

- (a) 30 000 km
(b) 60 000 km
(c) Grey sticker on ignition coil
(d) Green sticker on ignition coil

- (e) Hex 21 mm
(f) Hex 16 mm
(g) Recommended for cold weather



KW/HP



Box
10

Blister
4



F3-D1

CITROËN

	14, 1.4 i	TU3M [KDX - KDZ]	55/75	09.1988		RFC 58 LZK (a)	A11	B29	0,9	F54
	14, 1.4 i	TU3M [KDX - KDZ]	55/75	09.1988		RFN 58 LZ (b)	A7	B28	0,9	F54
	14, 1.4 i	TU3M [KDX - KDZ]	55/75	09.1988		RFN 58 LZ3A (g)	A515		0,9	
	14, 1.4 Leader	XY7 [150D]	46-53/63-72	05.1986	05.1988	C 62 LJS	A19	B2	0,9	J65
	15, 1.6 RE, TGE, TRE, Image	XU51C [B1A]	55/75	07.1987	06.1988	C 62 LJS	A19	B2	0,9	J65
	15, 1.6 RE, TGE, TRE, Image	XU51C [B1A]	55/75	07.1988	09.1993	RFC 58 LZK (a)	A11	B29	0,9	F54
	15, 1.6 Tonic	XU51C-K [B1F]	58/79	07.1987	09.1993	RFC 58 LZK (a)	A11	B29	0,9	F54
	16, 1.6	XU52C [B2C]	67/91	02.1988	09.1993	RFC 58 LZK (a)	A11	B29	0,9	F54
	16, 1.6	171/A - XU5STR	66/90	10.1982	03.1988	C 62 LJS	A19	B2	0,9	J65
	16, 1.6 i	XU5JA [B6D - B6E]	76-85/103-115	07.1987	09.1993	RFC 58 LZK (a)	A11	B29	0,9	F54
	16, 1.6 i	XU5JA [B6D - B6E]	76-85/103-115	07.1987	09.1993	RFN 58 LZ (b)	A7	B28	0,9	F54
	16, 1.6 i	XU5JA [B6D - B6E]	76-85/103-115	07.1987	09.1993	RFN 58 LZ3A (g)	A515		0,9	
	16, 1.6 RS	XU5STR [171D]	65/88	02.1985	03.1988	C 62 LJS	A19	B2	0,9	J65
	16, 1.6 RS	XU5STR [171D]	65/88	04.1988	09.1993	RFC 58 LZK (a)	A11	B29	0,9	F54
	16, 1.6 RS, TRS	171/A	66/90	04.1988	09.1993	RFC 58 LZK (a)	A11	B29	0,9	F54
	16, 1.6 RS, TRS	171/A	66/90	10.1982	03.1988	C 62 LJS	A19	B2	0,9	J65
	16, 1.6 S, RS, TRS, TGS, TZS	XU5S [171C-171Z]		07.1988	09.1993	RFC 58 LZK (a)	A11	B29	0,9	F54
	16, 1.6 S, RS, TRS, TGS, TZS	XU5CP [BAZ]	54/73	09.1986	10.1989	RFC 58 LZK (a)	A11	B29	0,9	F54
	19, 1.9 Digit, GT	XU9 S [159A-159Z]	77/105	10.1984	07.1986	C 72 LJS	A22		0,6	J87
	19, 1.9 i	XU9M - J1 - J2 - JA	75-92/102-125	07.1986	09.1993	RFN 58 LZ (b)	A7	B28	0,9	F54
	19, 1.9 i	XU9M - J1 - J2 - JA	75-92/102-125	07.1986	09.1993	RFC 58 LZK (a)	A11	B29	0,9	F54
	19, 1.9 i	XU9M - J1 - J2 - JA	75-92/102-125	07.1986	09.1993	RFN 58 LZ3A (g)	A515		0,9	
	19, 1.9 Millesime, TGS, TRS, TZS	XU92 C [D2A-D2B-D2C]	70/95	07.1987	09.1993	RFC 58 LZK (a)	A11	B29	0,9	F54
	19, 1.9 Millesime, TGS, TRS, TZS	XU92 C [D2A-D2B-D2C]	70/95	09.1986	07.1987	C 72 LJS	A22		0,6	J87
	19, 1.9 Millesime, TGS, TRS, TZS, Athena, 4x4	XU92 C+ [D2E-D2F]	79/107	02.1989	09.1993	RFC 58 LZK (a)	A11	B29	0,9	F54
	19, 1.9 Sport	XU9.4 [159B]	93/126	03.1985	07.1987	C 72 LJS	A22		0,6	J87
BX Break	11, 1.1, Break	HDZ (TU1M)	40/54	10.1988	06.1992	RFC 52 LS	A3	B16	0,8	F54
	14 E, Break	150F	49/67	09.1985	02.1993	RC 52 LJS	A62	B27	0,6	J65
	14 E, Break		59/80	10.1985	05.1989	RC 52 LJS	A62	B27	0,6	J65
	14, Break	K1H (TU3A)	47/64	01.1989	12.1989	RFC 52 LS	A3	B16	0,8	F54
	14, Break	KDY (TU3M)/KDZ (TU3M/Z)	55/75	01.1989	02.1993	RFN 52 LZ	A27		0,9	F54
	15, 1.6, Break	B1E (XU51C)	59/80	10.1987	05.1992	RFC 52 LS	A3	B16	0,8	F54
	16, 1.6, Break	B1E (XU51C)	53/72	01.1987	02.1993	RFC 52 LS	A3	B16	0,8	F54
	16, 1.6, Break	180Z	76/103	03.1986	06.1987	RC 72 LJS	A88		0,6	J87
	16, 1.6, Break	171A/171B/171C	66/90	06.1985	06.1988	RFC 52 LS	A3	B16	0,8	F54
	16, 1.6, Break	171D	64/87	07.1985	06.1987	C 62 LJS	A19	B2	0,9	J65
	16, 1.6, Break	180Z	76/103	07.1987	02.1993	RFC 52 LS	A3	B16	0,8	F54
	16, 1.6, Break	BAY (XU5CP)/BAZ (XU5CP)	55/75	09.1988	02.1993	RFC 52 LS	A3	B16	0,8	F54
	16 E, Break	BDY (XU5M)/BDZ (XU5M)	65/88	05.1989	02.1993	RFC 52 LS	A3	B16	0,8	F54
	19 E 4x4, Break	D2F	80/109	04.1989	02.1993	RFC 52 LS	A3	B16	0,7	F54
	19 E, Break	DDZ (XU9M)	80/109	06.1988	02.1993	RFN 52 LZ	A27		0,7	F54
	19 GTi 16V, Break	D6C (XU9J4)	116/158	09.1987	12.1988	RFC 62 LS	A48		0,7	F86
	19 GTi, 4x4, Break	DKZ (XU9JA)	88/120	06.1988	02.1993	RFC 52 LS	A3	B16	0,7	F54
	19 KAT, Break	DFZ (XU9J1)	75/102	07.1986	06.1987	RC 52 LJS	A62	B27	0,6	J65
	19 KAT, Break	DFZ (XU9J1)	75/102	07.1987	12.1994	RFN 52 LZ	A27		0,9	F54
	19, Break	D2A (XU92C)	77/105	07.1986	05.1989	RFC 52 LS	A3	B16	0,8	F54
	19, Break	D2C (XU92C)	70/95	07.1989	11.1989	RFC 52 LS	A3	B16	0,7	F54
C1	NEW 1.0	1KR-FE	50/68	06.2005		RFN 58 HZ5	A534		1.15	
C1 II	NEW 1.0 VTi 68	1KR-FE	51/69	04.2014		RWN 42 HSPiW	A544		1.0	
	NEW 1.2 VTi	EB2D	60/82	04.2014		RZN 32 HSWDP	A531		1.0	
C2	1.1	HFX (TU1JP)	44/60	09.2003		RFN 58 LZ (b)	A7	B28	0,9	F54
	1.1	HFX (TU1JP)	44/60	09.2003		RFC 58 LZK (a)	A11	B29	0,9	F54
	1.1	HFX (TU1JP)	44/60	09.2003		RFN 58 LZ3A (g)	A515		0,9	
	1.1 i	TU1JP-L4 [HFZ]	44/60	09.2003		RFC 58 LZK (a)	A11	B29	0,9	F54
	1.1 i	TU1JP-L4 [HFZ]	44/60	09.2003		RFN 58 LZ (b)	A7	B28	0,9	F54
	1.1 i	TU1JP-L4 [HFZ]	44/60	09.2003		RFN 58 LZ3A (g)	A515		0,9	
	1.4 i	TU3JP (KFV)	54/73	09.2003		RFC 58 LZK (a)	A11	B29	0,9	F54
	1.4 i	TU3JP (KFV)	54/73	09.2003		RFN 58 LZ (b)	A7	B28	0,9	F54
	1.4 i	TU3JP (KFV)	54/73	09.2003		RFN 58 LZ3A (g)	A515		0,9	
	1.4 i	TU3JP [KFX]	55/75	09.2003		RFC 58 LZK (a)	A11	B29	0,9	F54
	1.4 i	TU3JP [KFX]	55/75	09.2003		RFN 58 LZ (b)	A7	B28	0,9	F54
	1.4 i	TU3JP [KFX]	55/75	09.2003		RFN 58 LZ3A (g)	A515		0,9	
	1.4 16V	KFU (ET3J4)	65/88	06.2006		RWC 52 HSK	A197	B58	0,9	
	1.6	NFU (TU5JP4)	80/109	09.2003		RFN 58 HZ	A158		0,9	

(f) Available until end of stock

(a) 30 000 km

(b) 60 000 km

(c) Grey sticker on ignition coil

(d) Green sticker on ignition coil

(e) Hex 21 mm

(f) Hex 16 mm

(g) Recommended for cold weather



EYQUEM



Box
10

Blister
4



F3

CITROËN

	1.6	NFU (TU5JP4)	80/109	09.2003		RFN 58 HZ3A (g)	A516	0,9	
	1.6 i 16V	TU5 JP4-L4 [NFU] [DOHC]	80/109	09.2003		RFN 58 HZ	A158	0,9	
	1.6 i 16V	TU5 JP4-L4 [NFU] [DOHC]	80/109	09.2003		RFN 58 HZ3A (g)	A516	0,9	
C2 Sport	1.6 i VTS	TU5 JP4S	90/122	05.2005		RFC 96 HS3	A196	1,2	
C3	1.1 i	HFX (TU1JP)	44/60	02.2002		RFN 58 LZ (b)	A7	B28	0,9 F54
	1.1 i	HFX (TU1JP)	44/60	02.2002		RFN 58 LZ3A (g)	A515		0,9
	1.1 i	TU1JP [HFX]	44/60	02.2002		RFC 58 LZK (a)	A11	B29	0,9 F54
	1.1 i	TU1JP [HFX]	44/60	02.2002		RFN 58 LZ (b)	A7	B28	0,9 F54
	1.1 i	HFX (TU1JP)	44/60	02.2002		RFN 52 LZ	A27		0,7 F54
	1.1 i	TU1JP [HFX]	44/60	02.2002		RFN 58 LZ3A (g)	A515		0,9
	1.4 i	TU3JP [KFX]	55/75	02.2002		RFC 58 LZK (a)	A11	B29	0,9 F54
	1.4 i	TU3JP [KFX]	55/75	02.2002		RFN 58 LZ (b)	A7	B28	0,9 F54
	1.4 i	KFV (TU3JP)	54/73	02.2002		RFN 52 LZ	A27		0,7 F54
	1.4 i	TU3JP [KFX]	55/75	02.2002		RFN 58 LZ3A (g)	A515		0,9
	1.4 i	KFV (TU3JP)	54/73	02.2002		RFN 58 LZ (b)	A7	B28	0,9 F54
	1.4 i	KFV (TU3JP)	54/73	02.2002		RFN 58 LZ3A (g)	A515		0,9
	1.4 16V	KFU (ET3J4)	65/88	12.2003		RWC 52 HSK	A197	B58	0,9
	1.4 i 16V	ET3	65/88	02.2002		RWC 52 HSK	A197	B58	0,9
	1.4 i Bivalent	KFV (TU3JP)	54/73	02.2002		RFN 58 LZ (b)	A7	B28	0,9 F54
	1.4 i Bivalent	KFV (TU3JP)	54/73	02.2002		RFC 58 LZK (a)	A11	B29	0,9 F54
	1.4 i Bivalent	KFV (TU3JP)	54/73	02.2002		RFN 58 LZ3A (g)	A515		0,9
	1.6 16V	NFU (TU5JP4)	80/109	02.2002	08.2005	RFN 58 HZ	A158		0,9
	1.6 16V	NFU (TU5JP4)	80/109	02.2002	08.2005	RFN 58 HZ3A (g)	A516		0,9
	1.6 i 16V	TU5 JP4-L4 [NFU] [DOHC]	80/109	02.2002		RFN 58 HZ	A158		0,9
	1.6 i 16V	TU5 JP4-L4 [NFU] [DOHC]	80/109	02.2002		RFN 58 HZ3A (g)	A516		0,9
C3 Picasso	NEW 1.2 THP 110	HNZ (EB2DT)	81/110	01.2015		RXN 72 HSIPFS	A541		0,75
	1.4 VTi 95	8FS (EP3)	70/95	02.2009		RXC 42 HSEDP2A	A513		1,0
	1.4 VTi 95 LPG	8FN (EP3)	70/95	01.2012		RXC 58 HSEDP	A500		1,0
	1.6 VTi 120	5FW (EP6)	88/120	02.2009		RXN 62 HSDP	A525		0,7
C3 Pluriel	1.4	KFV (TU3JP)	40/54	05.2003		RFN 52 LZ	A27		0,7 F54
	1.4	KFV (TU3JP)	54/73	05.2003		RFN 58 LZ (b)	A7	B28	0,9 F54
	1.4	KFV (TU3JP)	54/73	05.2003		RFC 58 LZK (a)	A11	B29	0,9 F54
	1.4	KFV (TU3JP)	54/73	05.2003		RFN 58 LZ3A (g)	A515		0,9
	1.6	NFU (TU5JP4)	80/109	05.2003		RFN 58 HZ	A158		0,9
	1.6	NFU (TU5JP4)	80/109	05.2003		RFN 58 HZ3A (g)	A516		0,9
C3 II	NEW 1.0 VTi 68	ZMZ (EB0)	50/68	08.2012		RZN 32 HSWDP	A531		1,0
	1.1	HFX (TU1JP)	44/60	11.2009		RFN 58 LZ (b)	A7	B28	0,9 F54
	1.1	HFX (TU1JP)	44/60	11.2009		RFC 58 LZK (a)	A11	B29	0,9 F54
	1.1	HFX (TU1JP)	54/73	11.2009		RFN 58 LZ3A (g)	A515		0,9
	NEW 1.2 THP 110	HNZ (EB2DT)	81/110	10.2014		RXN 72 HSIPFS	A541		0,75
	NEW 1.2 VTi 82	HMZ (EB2F)	60/82	06.2012		RZN 32 HSWDP	A531		1,0
	1.4	KFT (TU3A)	54/73	11.2009		RFN 58 LZ (b)	A7	B28	0,9 F54
	1.4	KFT (TU3A)	54/73	11.2009		RFC 58 LZK (a)	A11	B29	0,9 F54
	1.4	KFT (TU3A)	54/73	11.2009		RFN 58 LZ3A (g)	A515		0,9
	1.4 LPG	8FN (EP3)	70/95	06.2013		RXC 58 HSEDP	A500		1,0
	1.4 VTi 95	8FP (EP3)	70/95	11.2009		RXC 42 HSEDP2A	A513		1,0
	1.6 VTi 120	5FS (EP6C)	88/120	11.2009		RXN 62 HSDP	A525		0,7
C3 III (SX)	NEW 1.2 VTi 82	HMZ (EB2F)	60/82	07.2016		RZN 32 HSWDP	A531		1,0
	NEW 1.2 THP 110	HNZ (EB2DT) - HNV (EB2DTM)	81/110	07.2016		RXN 72 HSIPFS	A541		0,75
	NEW 1.6 VTi	NFP (EC5)	85/115	01.2017		RFN 52 HZ	A157	B50	0,9
	NEW 1.6 VTi	NFP (EC5)	85/115	01.2017		RFN 52 HZ3A (g)	A100		0,9
C3 AIRCROSS II	NEW 1.2 Puretech 82	HMZ (EB2F)	60/82	06.2016		RZN 32 HSWDP	A531		1,0
	NEW 1.2 Puretech 110	HNZ (EB2DT) - HNV (EB2DTM)	81/110	06.2017		RXN 72 HSIPFS	A541		0,75
	NEW 1.2 Puretech 130	HNY (EB2DTS)	96/130	07.2017		RXN 72 HSIPFS	A541		0,75
C4	1.4 i 16V	ET3	65/88	11.2004	07.2011	RWC 52 HSK	A197	B58	0,9
	1.4 16V	KFU (ET3J4)	65/88	11.2004	07.2011	RWC 52 HSK	A197	B58	0,9
	1.6 i 16V	TU5 JP4-L4	80/109	11.2004	07.2011	RFN 58 HZ	A158		0,9
	1.6 i 16V	TU5 JP4-L4	80/109	11.2004	07.2011	RFN 58 HZ3A (g)	A516		0,9
	1.6 16V	NFU (TU5JP4)	80/109	11.2004		RFN 58 HZ	A158		0,9
	1.6 16V	NFU (TU5JP4)	80/109	11.2004		RFN 58 HZ3A (g)	A516		0,9
	1.6 16V Bio-Flex	NFU (TU5JP4)	80/109	09.2007	07.2008	RFN 58 HZ	A158		0,9
	1.6 16V Bio-Flex	NFU (TU5JP4)	80/109	09.2007	07.2008	RFN 58 HZ3A (g)	A516		0,9
	1.6 VTi 120	5FW (EP6)	88/120	07.2008	07.2011	RXC 58 HSEDP	A500		1,0
	1.6 THP 140	5FT (EP6DT)	103/140	07.2008	07.2011	RXN 62 HSDP	A525		0,7
	1.6 THP 150	5FX (EP6DT)	110/150	07.2008	07.2011	RXN 62 HSDP	A525		0,7

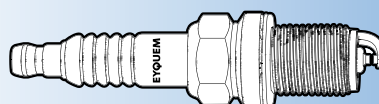

(1) Available until end of stock

- (a) 30 000 km
- (b) 60 000 km
- (c) Grey sticker on ignition coil
- (d) Green sticker on ignition coil

- (e) Hex 21 mm
- (f) Hex 16 mm
- (g) Recommended for cold weather



kW/HP

Box
10Blister
4

F3-1

CITROËN

	2.0 i 16V	EW10 J4-L4	100/136	11.2004	07.2007	RFN 52 HZ	A157	B50	0,9
	2.0 i 16V	EW10 J4-L4	100/136	11.2004	07.2007	RFN 52 HZ3A (g)	A100		0,9
	2.0 16V	RFN (EW10J4)	100/136	11.2004	07.2007	RFN 52 HZ	A157	B50	0,9
	2.0 16V	RFN (EW10J4)	100/136	11.2004	07.2007	RFN 52 HZ3A (g)	A100		0,9
	2.0 16V	RFJ-EW10A/EW10A	103/140	11.2004	07.2011	RFN 52 HZ3A (g)	A100		0,9
	2.0 16V	EW10J4S/RFK (EW10J4S)	130/177	11.2004	07.2008	RFN 58 HZ	A158		0,9
	2.0 16V	EW10J4S/RFK (EW10J4S)	130/177	11.2004	07.2008	RFN 58 HZ3A (g)	A516		0,9
C4 II (B7)	NEW 1.2 THP 110	HNZ (EB2DT)	81/110	02.2015		RXN 72 HSI PFS	A541		0,75
	NEW 1.2 THP 130	HNY (EB2DTS)	96/130	04.2014		RXN 72 HSI PFS	A541		0,75
	1.4 VTi 95	8FP (EP3)	70/95	11.2009		RXC 42 HSEDP2A	A513		1,0
	1.6 VTi 120	5FS (EP6C)	88/120	11.2009		RXN 62 HSDP	A525		0,7
	1.6 VTi 120 LPG	5FS (EP6C)	88/120	09.2011		RXN 62 HSDP	A525		0,7
	1.6 THP 155	5FV (EP6DT)	115/156	11.2009		RXN 62 HSDP	A525		0,7
C4 CACTUS	NEW 1.2 THP 110	HNZ (EB2DT)	81/110	09.2014		RXN 72 HSI PFS	A541		0,75
	NEW 1.2 VTi 75	HMU (EB2D)	55/75	09.2014		RZN 32 HSWDP	A531		1,0
	NEW 1.2 VTi 82	HMZ (EB2F)	60/82	09.2014		RZN 32 HSWDP	A531		1,0
C4 Coupe	1.4 16V	KFU (ET3J4)	65/88	11.2004	07.2011	RWC 52 HSK	A197	B58	0,9
	1.6 16V	NFU (TU5JP4)	80/109	11.2004	07.2011	RFN 58 HZ	A158		0,9
	1.6 16V	NFU (TU5JP4)	80/109	11.2004	07.2011	RFN 58 HZ3A (g)	A516		0,9
	1.6 VTi 120	5FW (EP6)	88/120	07.2008	07.2011	RXC 58 HSEDP	A500		1,0
	1.6 THP 150	5FX (EP6DT)	110/150	07.2008	07.2011	RXN 62 HSDP	A525		0,7
	2.0 16V	RFN (EW10J4)	100/136	11.2004	07.2007	RFN 52 HZ	A157	B50	0,9
	2.0 16V	RFN (EW10J4)	100/136	11.2004	07.2007	RFN 52 HZ3A (g)	A100		0,9
	2.0 16V	EW10J4S/RFK (EW10J4S)	130/177	11.2004	12.2010	RFN 58 HZ	A158		0,9
	2.0 16V	EW10J4S/RFK (EW10J4S)	130/177	11.2004	12.2010	RFN 58 HZ3A (g)	A516		0,9
C4 Grand Picasso I	1.6 16V	5FT (EP6DT)	103/140	07.2008		RXC 58 HSEDP	A500		1,0
	1.6 16V	5FX (EP6DT)	110/150	10.2008		RXN 62 HSDP	A525		0,7
	1.6 VTi 120	5FW (EP6)	88/120	07.2008		RXC 58 HSEDP	A500		1,0
	1.6 THP 155	5FV (EP6CDT)	115/156	09.2010		RXN 62 HSDP	A525		0,7
	1.8 i 16V	6FY (EW7A)	92/125	10.2006		RFN 52 HZ	A157		0,9
	1.8 i 16V	6FY (EW7A)	92/125	10.2006		RFN 52 HZ3A	A100		0,9
	2.0 i 16V	RFJ-EW10A	103/140	10.2006		RFN 52 HZ3A (g)	A100		0,9
C4 Grand Picasso II	NEW 1.2 THP 130	HNY (EB2DTS)	96/130	04.2014		RXN 72 HSI PFS	A541		0,75
	1.6 VTi 120	EP6C	88/120	09.2013		RXC 58 HSEDP	A500		1,0
	1.6 VTi 155	EP6CDT	115/156	09.2013		RXN 62 HSDP	A525		0,7
	1.6 THP 165	5GZ (EP6FDT)	121/165	07.2014		RXN 62 HSDP	A525		0,8
C4 Picasso I	1.6 16V	5FX (EP6DT)	110/150	07.2008	08.2013	RXN 62 HSDP	A525		0,7
	1.6 VTi 120	5FW (EP6)	88/120	07.2008	08.2013	RXC 58 HSEDP	A500		1,0
	2.0 i 16V	RFJ-EW10A	103/140	02.2007		RFN 52 HZ3A (g)	A100		0,9
	1.6 THP 140	5FT (EP6DT)	103/140	07.2008	08.2013	RXN 62 HSDP	A525		0,7
	1.6 THP 155	5FV (EP6CDT)	115/156	09.2010	08.2013	RXN 62 HSDP	A525		0,7
	1.8 i 16V	6FY (EW7A)	92/125	02.2007	12.2011	RFN 52 HZ	A157	B50	0,9
	1.8 i 16V	6FY (EW7A)	92/125	02.2007	12.2011	RFN 52 HZ3A (g)	A100		0,9
	2.0 i 16V	RFJ (EW10A)	103/140	02.2007	08.2013	RFN 52 HZ3A (g)	A100		0,9
C4 Picasso II	NEW 1.2 THP 130	HNY (EB2DTS)	96/130	04.2014		RXN 72 HSI PFS	A541		0,75
	1.6 VTi 120	EP6C	88/120	09.2013		RXC 58 HSEDP	A500		1,0
	1.6 THP	5FV (EP6CDT)	115/156	02.2013		RXN 62 HSDP	A525		0,7
	1.6 VTi 155	EP6CDT	115/156	09.2013		RXN 62 HSDP	A525		0,7
	1.6 THP 165	5GZ (EP6FDT)	121/165	07.2014		RXN 62 HSDP	A525		0,8
C5	1.8 i 16V	EW7 J4 [6FZ]	85/115	03.2001		RFN 52 HZ	A157	B50	0,9
	1.8 i 16V	EW7 J4 [6FZ]	85/115	03.2001		RFN 52 HZ3A (g)	A100		0,9
	1.8 16V (DC6FZB, DC6FZE)	6FZ (EW7J4)	85/115	03.2001	08.2004	RFN 52 HZ	A157	B50	0,9
	1.8 16V (DC6FZB, DC6FZE)	6FZ (EW7J4)	85/115	03.2001	08.2004	RFN 52 HZ3A (g)	A100		0,9
	2.0 16V (DCRFNC, DCRFNF)	RFN (EW10J4)	100/136	03.2001	08.2004	RFN 52 HZ	A157	B50	0,9
	2.0 16V (DCRFNC, DCRFNF)	RFN (EW10J4)	100/136	03.2001	08.2004	RFN 52 HZ3A (g)	A100		0,9
	2.0 16V HPI (DCRLZB)	RLZ (EW10D)	103/140	03.2001	08.2004	RXC 42 HZGP5	A506		1,0
	NEW 3.0 V6	XFX (ES9J4S)	152/207	03.2001	08.2004	RFN 42 HZP5	A512		1,1
C5 II	1.8 16V (RC6FZB)	6FZ (EW7J4)	85/115	09.2004		RFN 52 HZ	A157	B50	0,9
	1.8 16V (RC6FZB)	6FZ (EW7J4)	85/115	09.2004		RFN 52 HZ3A (g)	A100		0,9
	NEW 1.8 16V (RC6FZB)	6FY (EW7A)	92/125	09.2005		RFN 52 HZ	A157	B50	0,9
	NEW 1.8 16V (RC6FZB)	6FY (EW7A)	92/125	09.2005		RFN 52 HZ3A (g)	A100		0,9
	2.0 16V (RCRFJB, RCRFJC)	EW10A	103/140	09.2004		RFN 52 HZ	A157	B50	0,9
	2.0 16V (RCRFJB, RCRFJC)	EW10A	103/140	09.2004		RFN 52 HZ3A (g)	A100		0,9
	NEW 3.0 V6 (RCXFUF)	XFX (ES9J4S)/ XFU(ES9A)	152/207	09.2004		RFN 42 HZP5	A512		1,1

(1) Available until end of stock

(a) 30 000 km

(b) 60 000 km

(c) Grey sticker on ignition coil

(d) Green sticker on ignition coil

(e) Hex 21 mm

(f) Hex 16 mm

(g) Recommended for cold weather

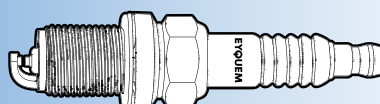

EYQUEM



Box
10

Blister
4



F3 → 1

CITROËN

C5 III	1.6 VTi 120	5FS (EP6C)	88/120	07.2010		RXC 58 HSEDP	A500		1.0	
	1.6 THP 150	5FN (EP6CDT)	110/150	07.2010		RXN 62 HSDP	A525		0.7	
	1.6 THP 155	5FV (EP6DT)	115/156	04.2009		RXN 62 HSDP	A525		0.7	
	NEW 1.8 16V (RC6FZB)	6FZ, 6FY (EW7A)	92/125	02.2008		RFN 52 HZ	A157	B50	0.9	
	NEW 1.8 16V (RC6FZB)	6FZ, 6FY (EW7A)	92/125	02.2008		RFN 52 HZ3A (g)	A100		0.9	
	2.0 16V	RFJ (EW10A)	103/140	02.2008		RFN 52 HZ3A (g)	A100		0.9	
	2.0 16V BioFlex	RFJ (EW10A)	103/140	02.2008		RFN 52 HZ3A (g)	A100		0.9	
	NEW 3.0 V6	XFU (ES9A)	155/211	02.2008		RFN 42 HZP5	A512		1.1	
	C5 Break	1.8 16V (DE6FZB, DE6FZE)	6FZ (EW7J4)	85/115	06.2001	08.2004	RFN 52 HZ	A157	B50	0.9
		1.8 16V (DE6FZB, DE6FZE)	6FZ (EW7J4)	85/115	06.2001	08.2004	RFN 52 HZ3A (g)	A100		0.9
2.0 16V (DERFNF, DERFNC, RERFNC)		RFN (EW10J4)	100/136	06.2001	08.2004	RFN 52 HZ	A157	B50	0.9	
2.0 16V (DERFNF, DERFNC, RERFNC)		RFN (EW10J4)	100/136	06.2001	08.2004	RFN 52 HZ3A (g)	A100		0.9	
2.0 16V HPi (DERLZB)		RLZ (EW10D)	103/140	06.2001	08.2004	RXC 42 HZGP5	A506		1.0	
3.0 Carlisson		XFX (ES9J4S)	173/235	09.2003	08.2004	RFN 42 HZP5	A512		1.1	
C5 II Break	1.8 16V (RE6FZB)	6FZ (EW7J4)	85/115	09.2004		RFN 52 HZ	A157	B50	0.9	
	1.8 16V (RE6FZB)	6FZ (EW7J4)	85/115	09.2004		RFN 52 HZ3A (g)	A100		0.9	
	1.8 16V	6FY (EW7A)	92/125	09.2005		RFN 52 HZ	A157	B50	0.9	
	1.8 16V	6FY (EW7A)	92/125	09.2005		RFN 52 HZ3A (g)	A100		0.9	
	2.0 16V (RERFJB, RERFJC)	RFJ (EW10A)	103/140	09.2004		RFN 52 HZ3A (g)	A100		0.9	
	NEW 3.0 V6 (RCXFUF)	XFU (ES9A)	152/207	09.2004		RFN 42 HZP5	A512		1.1	
C5 III Break	1.6 VTi 120	5FS (EP6C)	88/120	07.2010		RXC 58 HSEDP	A500		1.0	
	1.6 THP 150	5FN (EP6CDT)	110/150	04.2009		RXN 62 HSDP	A525		0.7	
	1.6 THP 155	5FV (EP6DT, EP6CDT)	115/156	04.2009		RXN 62 HSDP	A525		0.7	
	NEW 1.8 16V (RC6FZB)	6FZ, 6FY (EW7A)	92/125	09.2005		RFN 52 HZ	A157	B50	0.9	
	NEW 1.8 16V (RC6FZB)	6FZ, 6FY (EW7A)	92/125	09.2005		RFN 52 HZ3A (g)	A100		0.9	
	2.0 16V	RFJ (EW10A)	103/140	02.2008		RFN 52 HZ3A (g)	A100		0.9	
	NEW 2.0 16V BioFlex	RFJ (EW10A)	103/140	02.2008		RFN 52 HZ3A (g)	A100		0.9	
	NEW 3.0 V6	XFU (ES9A)	155/211	02.2008		RFN 42 HZP5	A512		1.1	
	C6	NEW 3.0 V6	XFX (ES9J4S), XFV (ES9A)	155/211	09.2005		RFN 42 HZP5	A512		1.1
		C8	2.0	RFN (EW10J4)	100/136	07.2002	RFN 52 HZ	A157	B50	0.9
C8	2.0	RFN (EW10J4)	100/136	07.2002		RFN 52 HZ3A (g)	A100		0.9	
	2.0 i 16V	RFN (EW10 J4-L4)	102/138	04.2002		RFN 52 HZ	A157	B50	0.9	
	2.0 i 16V	RFN (EW10 J4-L4)	102/138	04.2002		RFN 52 HZ3A (g)	A100		0.9	
	2.0 16V	RFJ (EW10A)	103/140	09.2005		RFN 52 HZ3A (g)	A100		0.9	
	2.0 16V	RFJ (EW10A)	104/141	09.2005		RFN 52 HZ3A (g)	A100		0.9	
	2.2 i 16V	3FZ (EW12J4)	116/158	04.2002		RFN 52 HZ	A157	B50	0.9	
	2.2 i 16V	3FZ (EW12J4)	116/158	04.2002		RFN 52 HZ3A (g)	A100		0.9	
	NEW 3.0 V6	XFX (ES9J4S)	150/204	07.2002		RFN 42 HZP5	A512		1.1	
	C-ELYSEE	NEW 1.2 VTi 72	EB2M	53/72	11.2012		RZN 32 HSWDP	A531		1.0
		NEW 1.2 VTi 82		60/82	12.2014		RZN 32 HSWDP	A531		1.0
NEW 1.6 VTi 115		NFP (EC5)	85/115	11.2012		RFN 52 HZ	A157	B50	0.9	
NEW 1.6 VTi 115		NFP (EC5)	85/115	11.2012		RFN 52 HZ3A (g)	A100		0.9	
CX	2.0, RE, TRE	829.A5 - J6R.A600	78/106	07.1979	08.1985	C 62 LJS	A19	B2	0,6 J65	
	2000, 2.0 Athena, Leader, Pallas, Reflex	829.A5	78/106	06.1979	06.1984	C 62 LJS	A19	B2	0,6 J65	
	2000, 2.0 Confort, Pallas, Super	M20.616	75/102	07.1974	06.1979	C 42 S	A12	B7	0,6 N43	
	22, 2.2 RS, TRS	J6T.A500	85/115	06.1981	07.1985	C 72 LJS	A22		0,6 J87	
	2200, 2.2	M22.617	82/112	09.1974	07.1976	C 42 S	A12	B7	0,6 N43	
	2.4 i GTi, ie, ie Prestige	M23.622	94/128	06.1977	06.1982	C 42 S	A12	B7	0,6 N43	
	2.4 i GTi, ie, ie Prestige	M23.622	96/131	06.1977	06.1982	C 42 S	A12	B7	0,6 N43	
	2400, 2.4 i	M23.623	85/115	08.1976	06.1980	C 42 S	A12	B7	0,6 N43	
	2400, 2.4 i	M23.639	88/120	05.1980	05.1982	C 42 S	A12	B7	0,6 N43	
	25, 2.5 i GTi, TRi, Ri, ie Pallas, Prestige	M25.659	100/136	07.1983	08.1985	C 62 S	A55		0,8	
	25 GTi Turbo 2	M25.662	122/166	06.1984	08.1985	C 62 S	A55		0,8	
	CX II	20 RE	829.A5	78/106	08.1985	12.1992	C 62 LJS	A19	B2	0,6 J65
		22 TRS	J6T.A500	83/113	07.1985	12.1992	C 72 LJS	A22		0,6 J87
22 TRS		J6T.A500	85/115	07.1985	07.1989	C 72 LJS	A22		0,6 J87	
25 GTi		M25.668	89/121	05.1986	12.1992	C 62	A20		0,8	
25 Tri		M25.659	100/136	08.1985	12.1992	C 62 S	A55		0,8	
25 GTi Turbo 2, Break		M25-667	115/156	09.1986	12.1992	C 62	A20		0,8	
25 GTi Turbo 2		M25.662	122/166	08.1985	12.1992	C 62	A20		0,8	
DS	D Spécial, Spécial Super, Super					C 42 S	A12	B7	0,6 N43	
	i DS / ID 19					C 42 S	A12	B7	0,6 N43	
	19		59/80	05.1959	04.1966	C 42 S	A12	B7	0,6 N43	
	19	B20700	62/84	04.1966	10.1972	C 42 S	A12	B7	0,6 N43	
	20		66/90	11.1968	10.1972	C 42 S	A12	B7	0,6 N43	

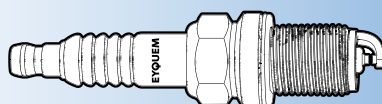

(1) Available until end of stock

- (a) 30 000 km
- (b) 60 000 km
- (c) Grey sticker on ignition coil
- (d) Green sticker on ignition coil

- (e) Hex 21 mm
- (f) Hex 16 mm
- (g) Recommended for cold weather



Box
10

Blister
4



F3→1

CITROËN

		20	B20744	72/98	07.1968	07.1975	C 42 S	A12	B7	0,6	N43	
		21	B22644	76/103	09.1965	08.1972	C 42 S	A12	B7	0,6	N43	
		21	B22627	88/120	12.1969	08.1975	C 42 S	A12	B7	0,6	N43	
		2.2	B22627	102/139	02.1969	06.1972	C 42 S	A12	B7	0,6	N43	
		23		81/110	09.1972	07.1975	C 42 S	A12	B7	0,6	N43	
		23		93/126	09.1972	07.1975	C 42 S	A12	B7	0,6	N43	
		Break 20	B20704	73/99	09.1972	07.1975	C 42 S	A12	B7	0,6	N43	
		Break 21	B22644	78/106	09.1972	07.1975	C 42 S	A12	B7	0,6	N43	
		Break 23		81/110	09.1972	07.1975	C 42 S	A12	B7	0,6	N43	
		19 Décapotable		61/83	08.1956	12.1965	C 42 S	A12	B7	0,6	N43	
		21 Décapotable	B22644	74/101	04.1968	03.1969	C 42 S	A12	B7	0,6	N43	
		21 Décapotable	B22644	78/106	04.1969	12.1971	C 42 S	A12	B7	0,6	N43	
DS3	NEW	1.2 THP 110	HNZ (EB2DT)	81/110	10.2014	03.2015	RXN 72 HSIPFS	A541			0.75	
	NEW	1.2 THP 130	HNY (EB2DTS)	96/130	09.2015		RXN 72 HSIPFS	A541			0.75	
	NEW	1.2 VTI 82	HMZ (EB2F)	60/82	01.2013	03.2015	RZN 32 HSWDP	A531			1,0	
		1.4 VTI 95	8FP (EP3)	70/95	04.2010	07.2015	RXC 42 HSEDP2A	A513			1,0	
		1.4 VTI 95 LPG	8FN (EP3)	70/95	08.2012	07.2015	RXC 42 HSEDP2A	A513			1,0	
		1.4 VTI 98	8FR (EP3)	72/98	11.2009	07.2015	RXC 42 HSEDP2A	A513			1,0	
		1.6 VTI 120	5FS (EP6C)	88/120	04.2010	07.2015	RXC 58 HSEDP	A500			1,0	
		1.6 THP 150	5FX (EP6DT), 5FN (EP6CDT)	110/150	01.2010	07.2015	RXN 62 HSDP	A525			0,7	
		1.6 THP 155	5FR (EP6DT), 5FV (EP6CDT)	115/156	04.2010	07.2015	RXN 62 HSDP	A525			0,7	
		1.6 THP 165	5GZ (EP6FDT)	121/165	10.2014	06.2015	RXN 62 HSDP	A525			0,8	
DS3 cabrio	NEW	1.2 THP 110	HNZ (EB2DT)	81/110	10.2014	07.2015	RXN 72 HSIPFS	A541			0.75	
	NEW	1.2 THP 130	HNY (EB2DTS)	96/130	09.2015		RXN 72 HSIPFS	A541			0.75	
	NEW	1.2 VTI 82	HMZ (EB2F)	60/82	01.2013	07.2015	RZN 32 HSWDP	A531			1,0	
		1.6 VTI 120	5FS (EP6C)	88/120	01.2013	07.2015	RXC 58 HSEDP	A500			1,0	
		1.6 THP 150	5FN (EP6CDT)	110/150	01.2013	07.2015	RXN 62 HSDP	A525			0,7	
		1.6 THP 155	5FV (EP6CDT)	115/156	01.2013	07.2015	RXN 62 HSDP	A525			0,7	
		1.6 THP 165	5GZ (EP6FDT)	121/165	10.2014	07.2015	RXN 62 HSDP	A525			0,8	
DS4	NEW	1.2 THP 130	HNY (EB2DTS)	96/130	07.2014	07.2015	RXN 72 HSIPFS	A541			0.75	
		1.6 VTI 120	5FS (EP6C)	88/120	04.2011	07.2015	RXC 58 HSEDP	A500			1,0	
		1.6 THP 155	5FR (EP6DT)	115/156	04.2011	07.2015	RXN 62 HSDP	A525			0,7	
		1.6 THP 160	5FM (EP6DT)	120/163	04.2012	07.2015	RXN 62 HSDP	A525			0,7	
		1.6 THP 165	5FM (EP6DT)-5GZ (EP6FDT)	121/165	01.2012	07.2015	RXN 62 HSDP	A525			0,8	
		1.6 THP 200	5FU (EP6DTX)	147/200	04.2011	07.2015	RXN 62 HSDP	A525			0,7	
DS4 CROSSBACK	NEW	1.2 THP 130	HNY (EB2DTS)	96/130	07.2015		RXN 72 HSIPFS	A541			0.75	
		1.6 THP 165	5GZ (EP6FDT)	121/165	07.2015		RXN 62 HSDP	A525			0,8	
DS5		1.6 THP 155	5FV (EP6DT)	115/156	11.2011	07.2015	RXN 62 HSDP	A525			0,7	
		1.6 THP 165 Hybrid	5FM (EP6DT)-5GZ (EP6FDT)	121/165	01.2015	04.2015	RXN 62 HSDP	A525			0,8	
		1.6 THP 200	5FU (EP6DTX)	147/200	11.2011	07.2015	RXN 62 HSDP	A525			0,7	
DYANE		4	A79/0 (AYA)	13/18	08.1967	03.1968	C 62	A20			0,6	
		4	A79/1 (AYA2)	17/23	04.1968	07.1975	C 62	A20			0,6	
		6	M28 (AM2)	21/29	12.1968	10.1984	C 62	A20			0,6	
		6	M28/1 (AK2)	24/33	05.1972	12.1980	C 62	A20			0,6	
EVASION		1.8	LFZ (XU7JP)	73/99	05.1997	07.2002	RFC 42 LZ2E	A5	B30	0,9	F54	
		1.8	XU7JP	73/99	07.1997	05.2001	RFC 42 LZ2E	A5	B30	0,9	F54	
		1.8 i	XU7 JP [LFZ] - [LFW]	72-74/98-101	09.1996		RFC 58 LZK (a)	A11	B29	0,9	F54	
		1.8 i	XU7 JP [LFZ] - [LFW]	72-74/98-101	09.1996		RFN 58 LZ (b)	A7	B28	0,9	F54	
		1.8 i	XU7 JP [LFZ] - [LFW]	72-74/98-101	09.1996		RFN 58 LZ3A (g)	A515			0,9	
		1.8 i		76/103	02.1996	12.1996	RFN 58 LZ (b)	A7	B28	0,9	F54	
		1.8 i		76/103	02.1996	12.1996	RFN 58 LZ3A (g)	A515			0,9	
		2.0	RFU (XU10J2/C)	89/121	06.1994	07.2002	RFN 52 LZ	A27			0,7	F54
		2.0 16V	RFV (XU10J4R)	97/132	05.1998	04.2000	RFN 52 LZ	A27			0,7	F54
		2.0 i	XU10 J2C [RFU]	89/121	06.1994		RFC 58 LZK (a)	A11	B29	0,9	F54	
		2.0 i	XU10 J2C [RFU]	89/121	06.1994		RFN 58 LZ (b)	A7	B28	0,9	F54	
		2.0 i	XU10 J2C [RFU]	89/121	06.1994		RFN 58 LZ3A (g)	A515			0,9	
		2.0 i X, SX, Prestige	XU10J2C (RFU)	89/121	07.1995		RFC 42 LZ2E	A5	B30	0,9	F54	
		2.0 i 16V	RFN (EW10 J4-L3)	100/136	05.2000	07.2002	RFN 52 HZ	A157	B50	0,9		
		2.0 i 16V	RFN (EW10 J4-L3)	100/136	05.2000	07.2002	RFN 52 HZ3A (g)	A100			0,9	
		2.0 i 16V	XU10 J4R [RFV]	100/136		04.2000	RFC 58 LZK (a)	A11	B29	0,9	F54	
		2.0 i 16V	XU10 J4R [RFV]	100/136		04.2000	RFN 58 LZ (b)	A7	B28	0,9	F54	
		2.0 i 16V	XU10 J4R [RFV]	100/136		04.2000	RFN 58 LZ3A (g)	A515			0,9	
		2.0 i Turbo	RGX (XU10 J2TE)	107-110/145-150	06.1994	07.2002	RFN 58 LZ (b)	A7	B28	0,9	F54	
		2.0 i Turbo	RGX (XU10 J2TE)	107-110/145-150	06.1994	07.2002	RFN 58 LZ3A (g)	A515			0,9	
		2.0 Turbo C.T.	RGX (XU10J2TE)	108/147	06.1994	07.2002	RFN 52 LZ	A27			0,7	F54

(1) Available until end of stock

(a) 30 000 km

(b) 60 000 km

(c) Grey sticker on ignition coil

(d) Green sticker on ignition coil

(e) Hex 21 mm

(f) Hex 16 mm

(g) Recommended for cold weather



EYQUEM



Box
10

Blister
4



F3

CITROËN

	2.2 i 16V	EW12 J4 [3FZ] [DOHC] Cat	116/158			RFN 52 HZ	A157	B50	0,9	
	2.2 i 16V	EW12 J4 [3FZ] [DOHC] Cat	116/158			RFN 52 HZ3A (g)	A100		0,9	
GS	1015, 1.0 thread 12,7 mm			08.1970	06.1980	C 72	A64		0,6	
	1015	G10/612	40/54	09.1970	09.1977	C 72 LS (1)	A30		0,6	L87
	1130	G11/631	40/54	09.1977	06.1980	C 72 LS (1)	A30		0,6	L87
	1130	G11/631	42/57	09.1977	07.1981	C 72 LS (1)	A30		0,6	L87
	1130, 1.1, Spécial, G Spécial conical seat			08.1974	06.1980	C 72 LJS (f)	A22		0,6	J87
	1130, 1.1, Spécial, G Spécial flat seat			08.1974	06.1980	C 72 LS (1) (e)	A30		0,6	L87
	1220, 1.2 Club, Club C-matic, Pallas, Pallas C-matic		43/58	08.1974	06.1980	C 62 LS	A4	B5	0,6	L65
	X2	G12/619	46/63	09.1975	07.1979	C 72 LS (1) (e)	A30		0,6	L87
	1300, 1.3			08.1974	06.1980	C 72 LS (1)	A30		0,6	L87
GSA	1015, 1.0 thread 12,7 mm			08.1974	06.1980	C 72	A64		0,6	
	1015, 1.0 thread 19 mm			08.1974	06.1980	C 72 LS (1)	A30		0,6	L87
	1130, 1.1			09.1977	08.1983	C 72 LS (1) (e)	A30		0,6	L87
	1130, 1.1			09.1977	08.1983	C 72 LJS (f)	A22		0,6	J87
	1220, 1.2			08.1974	12.1978	C 72 LS (1)	A30		0,6	L87
	1300, 1.3			09.1979	07.1986	C 62 LJS (f)	A19	B2	0,6	J65
	1300, 1.3			09.1979	07.1986	C 72 LS (1) (e)	A30		0,6	L87
	1.3 Pallas, Pallas C-matic			09.1979	07.1986	C 72 LS (1)	A30		0,6	L87
ID	19P		51/69	08.1959	09.1964	C 42 S	A12	B7	0,6	N43
	19P		54/73	09.1964	09.1969	C 42 S	A12	B7	0,6	N43
	19F		59/80	03.1965	10.1972	C 42 S	A12	B7	0,6	N43
	19B		57/78	09.1964	08.1975	C 42 S	A12	B7	0,6	N43
	19F Super	B20700	62/84	01.1966	10.1972	C 42 S	A12	B7	0,6	N43
	19B		66/90	11.1971	08.1975	C 42 S	A12	B7	0,6	N43
	20		66/90	01.1969	08.1975	C 42 S	A12	B7	0,6	N43
	20	B20744	64/87	11.1971	08.1975	C 42 S	A12	B7	0,6	N43
	21F	B22604	74/101	04.1966	11.1972	C 42 S	A12	B7	0,6	N43
	21F	B22644	76/103	02.1969	11.1972	C 42 S	A12	B7	0,6	N43
JUMPER (230P)	2.0	RFW (XU10J2U)	80/109	01.1994	04.2002	RFC 58 LZ2	A54		1	F54
JUMPER Kasten (230L)	2.0	RFW (XU10J2U)	80/109	03.1994	04.2002	RFC 58 LZ2	A54		1	F54
	2.0 4x4	RFW (XU10J2U)	80/109	10.1996	01.2000	RFC 58 LZ2	A54		1	F54
JUMPER Kasten (244)	2.0	XU10J2U	81/110	04.2002		RFC 58 LZ2	A54		1	
JUMPER Bus (244_Z)	2.0	XU10J2U	81/110	04.2002		RFC 58 LZ2	A54		1	F54
	2.0 Bivalent	XU10J2	81/110	02.2003		RFC 58 LZ2	A54		1	F54
JUMPER Pritsche/ Fahrgestell (230)	2.0	RFW (XU10J2U)	80/109	03.1994	04.2002	RFC 58 LZ2	A54		1	F54
JUMPER / RELAY	2.0, 4x4	RFW (XU10J2U)	80/109	02.1994	06.1995	RFN 52 LZ	A27		0,7	F54
	2.0, 4x4	RFW (XU10J2U)	80/109	07.1995	04.2002	RFC 58 LZ2	A54		1	F54
JUMPY / DISPATCH	1.6 i	1580 SPI (220 A2.000)	58/79	10.1995		RFN 62 LZ	A71		0,8	F86
	2.0	RFN (EW10J4)	100/136	04.2000	12.2006	RFN 52 HZ	A157	B50	0,7	
	2.0	RFN (EW10J4)	100/136	04.2000	12.2006	RFN 52 HZ3A (g)	A100		0,9	
	2.0 i 16V	RFH (EW10A)	103/140	03.2000	12.2006	RFN 52 HZ	A157	B50	0,7	
	2.0 i 16V	RFH (EW10A)	103/140	03.2000	12.2006	RFN 52 HZ3A (g)	A100		0,9	
	2.0 i 16V	RFH (EW10A)	103/140	01.2007		RFN 52 HZ	A157	B50	0,7	
	2.0 i 16V	RFH (EW10A)	103/140	01.2007		RFN 52 HZ3A (g)	A100		0,9	
LNA	602, 0.6	R06 627	24/33	07.1976	07.1979	C 62	A20		0,6	
	0.7 LNA 652 cm3	V06 644	25/34	11.1978	06.1986	C 72 LJS	A22		0,6	J87
	0.7 LNA 652 cm3	V06 630	26/35	11.1978	06.1986	C 72 LJS	A22		0,6	J87
	1.0	108C	33/45	07.1984	10.1986	RC 52 LJS	A62	B27	0,6	J65
	1.1	109/5E	37/50	07.1982	06.1986	C 62 LJS	A19	B2	0,6	J65
NEMO	1.4	KFT, KfV (TU3A)	54/73	04.2009		RFN 58 LZ (b)	A7	B28	0,9	F54
	1.4	KFT, KfV (TU3A)	54/73	04.2009		RFN 58 LZ3A (g)	A515		0,9	
MEHARI	0.6 Méhari	M28/1 (AK2)	19/26	05.1968	10.1979	C 62	A20		0,6	
	0.6 Méhari, Méhari 4x4	A06/635	21/29	10.1979	10.1987	C 62	A20		0,6	
SAXO	1.0 i X	CDZ (TU9M)	33/45	05.1996	11.1998	RFC 42 LZ2E	A5	B30	0,9	F54
	1.0 i	TU9M [CDY] [CDZ]	37/50	05.1998	06.2003	RFC 58 LZK (a)	A11	B29	0,9	F54
	1.0 i	TU9M [CDY] [CDZ]	37/50	05.1998	06.2003	RFN 58 LZ (b)	A7	B28	0,9	F54
	1.0 i	TU9M [CDY] [CDZ]	37/50	05.1998	06.2003	RFN 58 LZ3A (g)	A515		0,9	
	1.0 X	CDZ (TU9M)	33/45	05.1996		RFN 52 LZ	A27		0,7	F54
	1.0 X	CDZ (TU9M)	37/50	05.1998		RFN 52 LZ	A27		0,7	F54
	1.1 i	HDZ (TU1M), HDY	40-44/54-60	01.1996	09.2003	RFC 58 LZK (a)	A11	B29	0,9	F54
	1.1 i	HDZ (TU1M), HDY	40-44/54-60	01.1996	09.2003	RFN 58 LZ (b)	A7	B28	0,9	F54

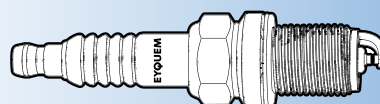

(1) Available until end of stock

- (a) 30 000 km
 (b) 60 000 km
 (c) Grey sticker on ignition coil
 (d) Green sticker on ignition coil

- (e) Hex 21 mm
 (f) Hex 16 mm
 (g) Recommended for cold weather



KW/HP



Box
10

Blister
4



F3-D1

CITROËN

	1.1 i	HDZ (TU1M), HDY	40-44/54-60	01.1996	09.2003	RFN 58 LZ3A (g)	A515		0,9	
	1.1 i	TU1JP-L4 [HFZ]	44/60	06.2000		RFC 58 LZK (a)	A11	B29	0,9	F54
	1.1 i	TU1JP-L4 [HFZ]	44/60	06.2000		RFN 58 LZ (b)	A7	B28	0,9	F54
	1.1 i	TU1JP-L4 [HFZ]	44/60	06.2000		RFN 58 LZ3A (g)	A515		0,9	
	1.1 X,SX	HDZ (TU1M)	40/54	05.1996	09.2003	RFC 58 LZ2	A54		1	F54
	1.1 X,SX	HDZ (TU1M)/HFZ (TU1JP)	44/60	05.1996	09.2003	RFC 58 LZ2	A54		1	F54
	1.4 i	TU3JP [K6C - KFX]	55/75	01.1996	06.2003	RFC 58 LZK (a)	A11	B29	0,9	F54
	1.4 i	TU3JP [K6C - KFX]	55/75	01.1996	06.2003	RFN 58 LZ (b)	A7	B28	0,9	F54
	1.4 i	TU3JP [K6C - KFX]	55/75	01.1996	06.2003	RFN 58 LZ3A (g)	A515		0,9	
	1.4 VTS	KFW (TU3JP)/KFX (TU3JP)	55/75	05.1996	06.2003	RFC 58 LZ2	A54		1	F54
	1.6 i	NFZ (TU5JP)	65/88	01.1996	06.2003	RFC 58 LZK (a)	A11	B29	0,9	F54
	1.6 i	NFZ (TU5JP)	65/88	01.1996	06.2003	RFN 58 LZ (b)	A7	B28	0,9	F54
	1.6 i	NFZ (TU5JP)	65/88	01.1996	06.2003	RFN 58 LZ3A (g)	A515		0,9	
	1.6	NFZ (TU5JP)	66/90	02.1996	06.2003	RFC 58 LZ2	A54		1	F54
	1.6 i 16V	TU5 J4 [NFX]	87-103/118-140	07.1996	09.2003	RFC 58 LZK (a)	A11	B29	0,9	F54
	1.6 i 16V	TU5 J4 [NFX]	87-103/118-140	07.1996	09.2003	RFN 58 LZ (b)	A7	B28	0,9	F54
	1.6 i 16V	TU5 J4 [NFX]	87-103/118-140	07.1996	09.2003	RFN 58 LZ3A (g)	A515		0,9	
	1.6 VTL,VTR	NFZ (TU5JP)	65/88	05.1996	06.2003	RFC 58 LZ2	A54		1	F54
	1.6 VTL,VTR	NFZ (TU5JP)	65/88	05.1996	06.2003	RFC 58 LZ2	A54		1	F54
	1.6 VTS	NFT (TU5JP4)	72/98	09.2000	09.2003	RFC 58 LZ2	A54		1	F54
	1.6	NFZ (TU5JP)	66/90	02.1996	06.2003	RFC 58 LZ2	A54		1	F54
	1.6	NFT (TU5JP)	74/101	01.2001	04.2004	RFN 58 LZ (b)	A7	B28	0,9	F54
	1.6	NFT (TU5JP)	74/101	01.2001	04.2004	RFN 58 LZ3A (g)	A515		0,9	
	1.6	NFX (TU5JP4)	88/120	02.1996	04.2004	RFC 58 LZ2	A54		1	F54
	SUPER 1600	TU5J4				FC 96 LS 3	A85		1,20	
TRACTION	Avant 1.9	11B -11BL	43/58			C 42 S	A12	B7	0,7	N43
SM	2.7	C114-1	118/160	04.1970	06.1972	C 52 LS	A1	B1	0,6	L65
	2.7 Injection	C114-03	129/175	06.1972	12.1974	C 52 LS	A1	B1	0,6	L65
	2.9 Automatic	C114-1130	134/182	09.1973	12.1974	C 52 LS	A1	B1	0,6	L65
VISA	0.65 i Club, Spécial, II Club, II Spécial	V06/665	24/33	07.1982	03.1991	C 72 LJS	A22		0,6	J87
	0.6	V06/630, V06/644	25/34	09.1978	06.1988	C 62 LJS	A19	B2	0,6	J65
	10, 1.0 i E, II E, Challenger	XV8	33/45	09.1984	06.1988	C 62 LJS	A19	B2	0,6	J65
	11, 1.1 i E, RE, L, II L, II Super E	109K	35/48	09.1978	06.1988	C 62 LJS	A19	B2	0,6	J65
	1.1 Super, Super E, Super E 5, Super X	109/5F	37/50	07.1982	03.1991	C 62 LJS	A19	B2	0,6	J65
	1.1	109/5	42/57	09.1978	03.1991	C 62 LJS	A19	B2	0,6	J65
	1.2 i L, Super E, Super X, II Super X	129/5	47/64	07.1980	06.1982	C 62 LJS	A19	B2	0,6	J65
	1.4	150/D (XY7)	44/60	07.1984	03.1991	C 62 LJS	A19	B2	0,6	J65
	1.4 GT	150/B (XY8)	55/75	03.1982	03.1987	C 72 LJS	A22		0,6	J87
	1.4 GT	150/B (XY8)	58/79	03.1982	03.1991	C 72 LJS	A22		0,6	J87
	1.4 Chrono, Super X	156/5A		03.1982	07.1982	883 LJP	A87		0,6	
	1.4 Chrono, Super X	156/5A		07.1982	03.1991	C 72 LJS	A22		0,6	J87
	14, 1.4 GT			09.1978	03.1991	C 72 LJS	A22		0,6	J87
	14, 1.4 RS, TRS, L, Super E				03.1991	C 62 LJS	A19	B2	0,6	J65
	1.6 GTi	B6D	83/113	06.1987	03.1991	FC 62 LS (1)	A43		0,6	
	1.6 GTi			09.1978	05.1987	C 72 LJS	A22		0,6	J87
	16 GTi	180A (XU5J)	76/103	01.1985	06.1986	RC 72 LJS	A88		0,6	J87
XANTIA (X1)	1.6 i X, SX	BFZ (XU5JP)	65/88	07.1995		RFC 42 LZ2E	A5	B30	0,9	F54
	1.8 i	XU7JB	66/90	04.1997	01.1998	RFC 58 LZ 2	A54		1	F54
	1.8 i X, SX, break	LFX (XU7JP4)	74/101	07.1995	01.1998	RFC 42 LZ2E	A5	B30	0,9	F54
	1.8 i	XU7JP [L6A] [LFZ] [LFW]	66-75/90-102			RFC 58 LZK (a)	A11	B29	0,9	F54
	1.8 i	XU7JP [L6A] [LFZ] [LFW]	66-75/90-102			RFN 58 LZ (b)	A7	B28	0,9	F54
	1.8 i	XU7JP [L6A] [LFZ] [LFW]	66-75/90-102			RFN 58 LZ3A (g)	A515		0,9	
	1.8 i 16V X, SX	XU7JP4	82/112	06.1995	01.1998	RFC 42 LZ2E	A5	B30	0,9	F54
	2.0 i SX, VSX	RFX (XU10J2C)	89/121	07.1995	01.1998	RFC 42 LZ2E	A5	B30	0,9	F54
	2.0 i	XU10J2C [RFX] [R6D] [RFZ]	89-90/121-123	03.1993	06.1995	RFC 58 LZK (a)	A11	B29	0,9	F54
	2.0 i	XU10J2C [RFX] [R6D] [RFZ]	89-90/121-123	03.1993	06.1995	RFN 58 LZ (b)	A7	B28	0,9	F54
	2.0 i	XU10J2C [RFX] [R6D] [RFZ]	89-90/121-123	03.1993	06.1995	RFN 58 LZ3A (g)	A515		0,9	
	2.0 i 16V	EW10 J4-L4 [RFN] [DOHC]	99-100/135-136			RFN 52 HZ	A157	B50	0,9	
	2.0 i 16V	EW10 J4-L4 [RFN] [DOHC]	99-100/135-136			RFN 52 HZ3A (g)	A100		0,9	
	2.0 i 16V, SX, VSX, Break, Activa, Athéna, Audace, Exclusive	RFV (XU10J4R)	97/132	06.1995	01.1998	RFC 42 LZ2E	A5	B30	0,9	F54
	2.0 i 16V Athéna, Audace, VSX	XU10 J4RS-L3 [RFS]	122/166	06.1996		RFC 58 LZK (a)	A11	B29	0,9	F54
	2.0 i 16V Athéna, Audace, VSX	XU10 J4RS-L3 [RFS]	122/166	06.1996		RFN 58 LZ (b)	A7	B28	0,9	F54
	2.0 i 16V Athéna, Audace, VSX	XU10 J4RS-L3 [RFS]	122/166	06.1996		RFN 58 LZ3A (g)	A515		0,9	
	2.0 i 16V VSX	RFT (XU10J4D-L3) [RFY]	110-112/150-152	06.1994	01.1998	RFC 58 LZK (a)	A11	B29	0,9	F54

(1) Available until end of stock

(a) 30 000 km

(b) 60 000 km

(c) Grey sticker on ignition coil

(d) Green sticker on ignition coil

(e) Hex 21 mm

(f) Hex 16 mm

(g) Recommended for cold weather

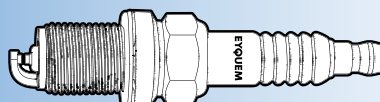

EYQUEM



Box
10

Blister
4



F3 → 1

CITROËN

	2.0 i 16V VSX	RFT (XU10J4D-L3) [RFY]	110-112/150-152	06.1994	01.1998	RFN 58 LZ (b)	A7	B28	0,9	F54
	2.0 i 16V VSX	RFT (XU10J4D-L3) [RFY]	110-112/150-152	06.1994	01.1998	RFN 58 LZ3A (g)	A515		0,9	
	2.0 i Turbo	XU10 J2TE [RGX- RGY]	108/147	06.1995	01.1998	RFC 58 LZ2E	A10	B31	0,9	F54
	3.0 i 24	XFZ (ES9J4-L3)	143/194	01.1997	01.1998	RFC 58 LZ2	A54		1	F54
XANTIA (X2)	1.8 i	LFX (XU7JB)	66/90	01.1998	04.2003	RFC 58 LZ2	A54		1	F54
	1.8 i 16V	LFY (XU7JP4)	81/110	01.1998	04.2003	RFC 58 LZK (a)	A11	B29	0,9	F54
	1.8 i 16V	LFY (XU7JP4)	81/110	01.1998	04.2003	RFN 58 LZ (b)	A7	B28	0,9	F54
	1.8 i 16V	LFY (XU7JP4)	81/110	01.1998	04.2003	RFN 58 LZ3A (g)	A515		0,9	
	2.0 i	RFX (XU10J2C)	89/121	01.1998	04.2003	RFC 58 LZK (a)	A11	B29	0,9	F54
	2.0 i	RFX (XU10J2C)	89/121	01.1998	04.2003	RFN 58 LZ (b)	A7	B28	0,9	F54
	2.0 i	RFX (XU10J2C)	89/121	01.1998	04.2003	RFN 58 LZ3A (g)	A515		0,9	
	2.0 i 16V	RFV (XU10J4R)	97/132	01.1998	04.2003	RFC 58 LZK (a)	A11	B29	0,9	F54
	2.0 i 16V	RFV (XU10J4R)	97/132	01.1998	04.2003	RFN 58 LZ (b)	A7	B28	0,9	F54
	2.0 i 16V	RFV (XU10J4R)	97/132	01.1998	04.2003	RFN 58 LZ3A (g)	A515		0,9	
	2.0 i Turbo	RGX (XU10J2TE)	108/147	01.1998	04.2003	RFC 58 LZK (a)	A11	B29	0,9	F54
	2.0 i Turbo	RGX (XU10J2TE)	108/147	01.1998	04.2003	RFN 58 LZ (b)	A7	B28	0,9	F54
	2.0 i Turbo	RGX (XU10J2TE)	108/147	01.1998	04.2003	RFN 58 LZ3A (g)	A515		0,9	
	3.0 V6	XFZ (ES9J4)	140/190	01.1998	04.2003	RFN 52 LZ	A27		0,9	F54
XM (Y3)	2.0 i	RDZ (XU10MZ)	79/107	05.1989	04.1994	RFN 58 LZ (b)	A7	B28	0,9	F54
	2.0 i	RDZ (XU10MZ)	79/107	05.1989	04.1994	RFC 58 LZK (a)	A11	B29	0,9	F54
	2.0 i	RDZ (XU10MZ)	79/107	05.1989	04.1994	RFN 58 LZ3A (g)	A515		0,9	
	2.0		84/114	05.1989	04.1994	RFC 42 LZ2E	A5	B30	0,9	F54
	2.0 i détente, présence, sensation	RFZ (XU10J2)	89/121	07.1989	06.1994	RFC 42 LZ2E	A5	B30	0,9	F54
	2.0	R6A	94/128	07.1989	06.1994	RFC 42 LZ2E	A5	B30	0,9	F54
	2.0 i 16V SX, VSX, break, Exclusive, Prestige	XU10J4R	99/135	07.1995		RFC 42 LZ2E	A5	B30	0,9	F54
	2.0 i Turbo	RGY (XU10J2TE/Z)	104/141	09.1992	06.1994	RFC 58 LZ2E	A10	B31	0,9	F54
	3.0 i V6	SFZ (ZPJ/Z, S6A - UFY - UFZ)	123/167	05.1989	06.1994	RFC 58 LS3	A16	B33	1,2	
	3.0 i V6 24v	SKZ, UKZ (ZPJ4/Z)	147/200	07.1990	06.1994	RFC 58 LS3	A16	B33	1,2	
XM (Y4)	2.0 i 16V	RFV (XU10J4R)	97/132	07.1994	10.2000	RFC 58 LZK (a)	A11	B29	0,9	F54
	2.0 i 16V	RFV (XU10J4R)	97/132	07.1994	10.2000	RFN 58 LZ (b)	A7			
	2.0 i 16V	RFV (XU10J4R)	97/132	07.1994	10.2000	RFN 58 LZ3A (g)	A515			
	2.0 i Turbo	RGX, RGY (XU10 J2TE)	108/147	05.1994	10.2000	RFN 58 LZ (b)	A7	B28	0,9	F54
	2.0 i Turbo	RGX, RGY (XU10 J2TE)	108/147	05.1994	10.2000	RFN 58 LZ3A (g)	A515		0,9	
	3.0 i V6 24v	XFZ (ES9J4-L3)	140/190	07.1997	10.2000	RFN 52 LZ	A27		0,9	F54
	3.0 i V6	SFZ, UFZ (ZPJ/Z)	125/170	05.1994	10.2000	RFC 58 LS3	A16	B33	1,2	
	3.0 i V6 24v	SKZ, UKZ (ZPJ4/Z)	147/200	05.1994	10.2000	RFC 58 LS3	A16	B33	1,2	
XM Break	2.0 i,Break	RDZ (XU10MZ)/XU102C	79/107	11.1991	04.1994	RFC 52 LS	A3	B16	0,7	F54
	2.0 i 16V,Break	RFV (XU10J4R)	97/132	05.1994	10.2000	RFC 52 LS	A3	B16	0,7	F54
	2.0 i Turbo,Break	RGY (XU10J2TE/Z)	104/141	09.1992	06.1994	RFN 52 LZ	A27		0,9	F54
	2.0 i,Break	RFZ (XU10J2)	89/121	05.1989	06.1994	RFN 52 LZ	A27		0,9	F54
	2.0 Turbo,Break	RGX (XU10J2TE)	108/147	05.1994	10.2000	RFN 52 LZ	A27		0,9	F54
XSARA (N1)	1.4 i	KFW, KFX (TU3JP)	55/75	09.1997	03.2005	RFC 58 LZK (a)	A11	B29	0,9	F54
	1.4 i	KFW, KFX (TU3JP)	55/75	09.1997	03.2005	RFN 58 LZ (b)	A7	B28	0,9	F54
	1.4 i	KFW, KFX (TU3JP)	55/75	09.1997	03.2005	RFN 58 LZ3A (g)	A515		0,9	
	1.6 i	NFZ (TU5JP)	65/88	09.1997	09.2000	RFC 58 LZK (a)	A11	B29	0,9	F54
	1.6 i	NFZ (TU5JP)	65/88	09.1997	09.2000	RFN 58 LZ (b)	A7	B28	0,9	F54
	1.6 i	NFZ (TU5JP)	65/88	09.1997	09.2000	RFN 58 LZ3A (g)	A515		0,9	
	1.6 i 16V	NFU (TU5JP4-L4)	80/109	09.2000	03.2005	RFN 58 HZ	A158		0,9	
	1.6 i 16V	NFU (TU5JP4-L4)	80/109	09.2000	03.2005	RFN 58 HZ3A (g)	A516		0,9	
	1.8 i	LFX (XU7JB)	66/90	04.1997	09.2000	RFC 58 LZ2	A54		1	F54
	1.8 i	LFZ (XU7JP)	74/101	04.1997	09.2000	RFC 42 LZ2E	A5	B30	0,9	F54
	1.8 i 16V	LFY (XU7JP4)	81/110	04.1997	09.2000	RFC 42 LZ2E	A5	B30	0,9	F54
	2.0 16V	RFV (XU10J4R)	97/132	07.1998	09.2000	RFC 58 LZK (a)	A11	B29	0,9	F54
	2.0 16V	RFV (XU10J4R)	97/132	07.1998	09.2000	RFN 58 LZ (b)	A7	B28	0,9	F54
	2.0 16V	RFV (XU10J4R)	97/132	07.1998	09.2000	RFN 58 LZ3A (g)	A515		0,9	
	2.0 i 16V	RFN (EW10J4-L4)	99-100/135-136	09.2000	03.2005	RFN 52 HZ	A157	B50	0,9	
	2.0 i 16V	RFN (EW10J4-L4)	99-100/135-136	09.2000	03.2005	RFN 52 HZ3A (g)	A100		0,9	
	2.0 16V	RFS (XU10J4RS)	120/163	04.1997	09.2000	RFN 62 LZ	A71		0,9	F86
XSARA Break (N2)	1.4 i	KFW, KFX (TU3JP)	55/75	10.1997	08.2005	RFC 58 LZK (a)	A11	B29	0,9	F54
	1.4 i	KFW, KFX (TU3JP)	55/75	10.1997	08.2005	RFN 58 LZ (b)	A7	B28	0,9	F54
	1.4 i	KFW, KFX (TU3JP)	55/75	10.1997	08.2005	RFN 58 LZ3A (g)	A515		0,9	
	1.6 i	NFZ (TU5JP)	65/88	10.1997	09.2000	RFC 58 LZK (a)	A11	B29	0,9	F54
	1.6 i	NFZ (TU5JP)	65/88	10.1997	09.2000	RFN 58 LZ (b)	A7	B28	0,9	F54
	1.6 i	NFZ (TU5JP)	65/88	10.1997	09.2000	RFN 58 LZ3A (g)	A515		0,9	

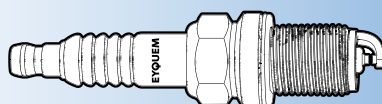

(1) Available until end of stock

- (a) 30 000 km
- (b) 60 000 km
- (c) Grey sticker on ignition coil
- (d) Green sticker on ignition coil

- (e) Hex 21 mm
- (f) Hex 16 mm
- (g) Recommended for cold weather



KW/HP



Box
10

Blister
4



F3-D1

CITROËN

	1.6 i 16V	NFU (TU5JP4)	80/109	09.2000	08.2005	RFN 58 HZ	A158		0,9		
	1.6 i 16V	NFU (TU5JP4)	80/109	09.2000	08.2005	RFN 58 HZ3A (g)	A516		0,9		
	1.8 i	LFX (XU7JB)	66/90	10.1997	09.2000	RFC 58 LZK (a)	A11	B29	0,9	F54	
	1.8 i	LFX (XU7JB)	66/90	10.1997	09.2000	RFN 58 LZ (b)	A7	B28	0,9	F54	
	1.8 i	LFX (XU7JB)	66/90	10.1997	09.2000	RFN 58 LZ3A (g)	A515		0,9		
	1.8 i Automatic	LFZ (XU7JP)	74/101	10.1997	09.2000	RFC 58 LZK (a)	A11	B29	0,9	F54	
	1.8 i Automatic	LFZ (XU7JP)	74/101	10.1997	09.2000	RFN 58 LZ (b)	A7	B28	0,9	F54	
	1.8 i Automatic	LFZ (XU7JP)	74/101	10.1997	09.2000	RFN 58 LZ3A (g)	A515		0,9		
	1.8 i 16V	LFY (XU7JP4)	81/110	10.1997	09.2000	RFC 58 LZK (a)	A11	B29	0,9	F54	
	1.8 i 16V	LFY (XU7JP4)	81/110	10.1997	09.2000	RFN 58 LZ (b)	A7	B28	0,9	F54	
	1.8 i 16V	LFY (XU7JP4)	81/110	10.1997	09.2000	RFN 58 LZ3A (g)	A515		0,9		
	2.0 i 16V	RFV (XU10J4R)	97/132	07.1998	09.2000	RFC 58 LZK (a)	A11	B29	0,9	F54	
	2.0 i 16V	RFV (XU10J4R)	97/132	07.1998	09.2000	RFN 58 LZ (b)	A7	B28	0,9	F54	
	2.0 i 16V	RFV (XU10J4R)	97/132	07.1998	09.2000	RFN 58 LZ3A (g)	A515		0,9		
	2.0 i 16V	RFN (EW10J4)	100/136	09.2000	08.2005	RFN 52 HZ	A157	B50	0,9		
	2.0 i 16V	RFN (EW10J4)	100/136	09.2000	08.2005	RFN 52 HZ3A (g)	A100		0,9		
XSARA Coupé (N0)	1.4 i Coupé	KFW (TU3JP)/KFX (TU3JP)	55/75	03.1998	03.2005	RFC 58 LZK (a)	A11	B29	0,9	F54	
	1.4 i Coupé	KFW (TU3JP)/KFX (TU3JP)	55/75	03.1998	03.2005	RFN 58 LZ (b)	A7	B28	0,9	F54	
	1.4 i Coupé	KFW (TU3JP)/KFX (TU3JP)	55/75	03.1998	03.2005	RFN 58 LZ3A (g)	A515		0,9		
	1.6 i Coupé	NFZ (TU5JP)	65/88	02.1998	09.2000	RFC 58 LZK (a)	A11	B29	0,9	F54	
	1.6 i Coupé	NFZ (TU5JP)	65/88	02.1998	09.2000	RFN 58 LZ (b)	A7				
	1.6 i Coupé	NFZ (TU5JP)	65/88	02.1998	09.2000	RFN 58 LZ3A (g)	A515				
	1.6 i 16V Coupé	NFU (TU5JP4)	80/109	09.2000	03.2005	RFN 58 HZ	A158		0,9		
	1.6 i 16V Coupé	NFU (TU5JP4)	80/109	09.2000	03.2005	RFN 58 HZ3A (g)	A516		0,9		
	1.8 i Coupé	LFX (XU7JB)	66/90	02.1998	09.2000	RFC 58 LZK (a)	A11	B29	0,9	F54	
	1.8 i Coupé	LFX (XU7JB)	66/90	02.1998	09.2000	RFN 58 LZ (b)	A7	B28	0,9	F54	
	1.8 i Coupé	LFX (XU7JB)	66/90	02.1998	09.2000	RFN 58 LZ3A (g)	A515		0,9		
	1.8 i Coupé	LFZ (XU7JP)	74/101	02.1998	09.2000	RFC 58 LZK (a)	A11	B29	0,9	F54	
	1.8 i Coupé	LFZ (XU7JP)	74/101	02.1998	09.2000	RFN 58 LZ (b)	A7	B28	0,9	F54	
	1.8 i Coupé	LFZ (XU7JP)	74/101	02.1998	09.2000	RFN 58 LZ3A (g)	A515		0,9		
	1.8 i 16V Coupé	LFY (XU7JP4)	81/110	02.1998	09.2000	RFC 58 LZK (a)	A11	B29	0,9	F54	
	1.8 i 16V Coupé	LFY (XU7JP4)	81/110	02.1998	09.2000	RFN 58 LZ (b)	A7	B28	0,9	F54	
	1.8 i 16V Coupé	LFY (XU7JP4)	81/110	02.1998	09.2000	RFN 58 LZ3A (g)	A515		0,9		
	2.0 16V Coupé	RFN (EW10J4)	100/136	09.2000	03.2005	RFN 52 HZ	A157	B50	0,9		
	2.0 16V Coupé	RFN (EW10J4)	100/136	09.2000	03.2005	RFN 52 HZ3A (g)	A100		0,9		
	2.0 i 16V Coupé	RFS (XU10J4RS)	120/163	02.1998	03.2005	RFN 62 LZ	A71		0,9	F86	
XSARA PICASSO (N68)	1.6	NFZ (TU5JP)	65/88	12.1999		RFC 58 LZ2	A54		1	F54	
	1.6	NFV (TU5JP)	70/95	12.1999		RFC 58 LZ2	A54		1	F54	
	1.6 Chrono		74/101	04.2001	10.2004	RFC 58 LZK (a)	A11	B29	0,9	F54	
	1.6 Chrono		74/101	04.2001	10.2004	RFN 58 LZ (b)	A7	B28	0,9	F54	
	1.6 Chrono		74/101	04.2001	10.2004	RFN 58 LZ3A (g)	A515		0,9		
	1.6 i 16V	NFU (TU5JP4-L3)	80/109	09.2005		RFN 58 HZ	A158		0,9		
	1.6 i 16V	NFU (TU5JP4-L3)	80/109	09.2005		RFN 58 HZ3A (g)	A516		0,9		
	1.8 i 16V	6FZ (EW7J4)	85/115	02.2000		RFN 52 HZ	A157	B50	0,9		
	1.8 i 16V	6FZ (EW7J4)	85/115	02.2000		RFN 52 HZ3A (g)	A100		0,9		
	2.0 16V	RFN (EW10J4)	100/136	01.2003		RFN 52 HZ	A157	B50	0,9		
	2.0 16V	RFN (EW10J4)	100/136	01.2003		RFN 52 HZ3A (g)	A100		0,9		
	ZX (N2)	1.1	TU1K (H1A - H1B)	40/54	03.1991	08.1996	RFC 58 LZK (a)	A11	B29	0,9	F54
		1.1	TU1K (H1A - H1B)	40/54	03.1991	08.1996	RFN 58 LZ (b)	A7	B28	0,9	
1.1		TU1K (H1A - H1B)	40/54	03.1991	08.1996	RFN 58 LZ3A (g)	A515		0,9		
1.1		HDZ (TU1M)	44/60	03.1991	06.1997	RFC 42 LZ2E	A5	B30	0,9	F54	
1.1 i		TU1M+ [HDY]	40/54	04.1994		RFC 58 LZK (a)	A11	B29	0,9	F54	
1.1 i		TU1M+ [HDY]	40/54	04.1994		RFN 58 LZ (b)	A7	B28	0,9	F54	
1.1 i		TU1M+ [HDY]	40/54	04.1994		RFN 58 LZ3A (g)	A515		0,9		
1.4		TU3.2 (K2C-K2D-K5A)	55/75	03.1991	06.1997	RFN 58 LZ (b)	A7	B28	0,9	F54	
1.4		TU3.2 (K2C-K2D-K5A)	55/75	03.1991	06.1997	RFC 58 LZK (a)	A11	B29	0,9	F54	
1.4		TU3.2 (K2C-K2D-K5A)	55/75	03.1991	06.1997	RFN 58 LZ3A (g)	A515		0,9		
1.4 i		TU3JP (K6C - KFX) - TU3M (KDX - KDY)	55/75	08.1991	06.1997	RFC 58 LZ2	A54		1	F54	
1.6 Aura, Avantage, Fugue		BFZ (XU5JP), BDY (XU5M)	65/88	03.1991	06.1997	RFC 42 LZ2E	A5	B30	0,9	F54	
1.6 i		NFZ (TU5JP), BFZ (XU5JP), BDY (XU5M/B4A)	66/90	07.1994	10.1997	RFC 58 LZK (a)	A11	B29	0,9	F54	
1.6 i		NFZ (TU5JP), BFZ (XU5JP), BDY (XU5M/B4A)	66/90	07.1994	10.1997	RFN 58 LZ (b)	A7	B28	0,9	F54	

(1) Available until end of stock

(a) 30 000 km

(b) 60 000 km

(c) Grey sticker on ignition coil

(d) Green sticker on ignition coil

(e) Hex 21 mm

(f) Hex 16 mm

(g) Recommended for cold weather



EYQUEM



Box
10

Blister
4



F3 → 1

CITROËN

	1.6 i	NFZ (TU5JP), BFZ (XU5JP), BDY (XU5M/B4A)	66/90	07.1994	10.1997	RFN 58 LZ3A (g)	A515		0,9	
	1.8 Aura, Avantage, Furio	LFX (XU7JP)	74/101	07.1992	06.1997	RFC 42 LZ2E	A5	B30	0,9	F54
	1.8 i	LFZ (XU7JP), (L6A)	76/103	07.1993	06.1997	RFC 58 LZK (a)	A11	B29	0,9	F54
	1.8 i	LFZ (XU7JP), (L6A)	76/103	07.1993	06.1997	RFN 58 LZ (b)	A7	B28	0,9	F54
	1.8 i	LFZ (XU7JP), (L6A)	76/103	07.1993	06.1997	RFN 58 LZ3A (g)	A515		0,9	
	1.8 i 16V	LFY (XU7JP4)	81/110	03.1997	06.1998	RFC 58 LZK (a)	A11	B29	0,9	F54
	1.8 i 16V	LFY (XU7JP4)	81/110	03.1997	06.1998	RFN 58 LZ (b)	A7	B28	0,9	F54
	1.8 i 16V	LFY (XU7JP4)	81/110	03.1997	06.1998	RFN 58 LZ3A (g)	A515		0,9	
	1.8 i	XU7JP4	82/112	04.1996	10.1997	RFC 42 LZ2E	A5	B30	0,9	F54
	1.9 i Volcane	DKZ (XU9JAZ) DFY (XU9JA-K)	90/122	03.1991	06.1997	RFC 58 LZK (a)	A11	B29	0,9	F54
	1.9 i Volcane	DKZ (XU9JAZ) DFY (XU9JA-K)	90/122	03.1991	06.1997	RFN 58 LZ (b)	A7	B28	0,9	F54
	1.9 i Volcane	DKZ (XU9JAZ) DFY (XU9JA-K)	90/122	03.1991	06.1997	RFN 58 LZ3A (g)	A515		0,9	
	1.9	D6E (XU9JA)	93/126	03.1991	06.1997	RFC 58 LZK (a)	A11	B29	0,9	F54
	1.9	D6E (XU9JA)	93/126	03.1991	06.1997	RFN 58 LZ (b)	A7	B28	0,9	F54
	1.9	D6E (XU9JA)	93/126	03.1991	06.1997	RFN 58 LZ3A (g)	A515		0,9	
	1.9	D6E (XU9JA)	96/131	03.1991	09.1997	RFC 58 LZK (a)	A11	B29	0,9	F54
	1.9	D6E (XU9JA)	96/131	03.1991	09.1997	RFN 58 LZ (b)	A7	B28	0,9	F54
	1.9	D6E (XU9JA)	96/131	03.1991	09.1997	RFN 58 LZ3A (g)	A515		0,9	
	2.0 Volcane	RFX (XU10J2C)	89/121	07.1992	06.1997	RFC 42 LZ2E	A5	B30	0,9	F54
	2.0 Volcane	RFX (XU10J2C)	90/122	07.1994	10.1997	RFC 42 LZ2E	A5	B30	0,9	F54
	2.0 i 16V	RFT (XU10J4-Z), RFY	110-112/150-152	07.1992	06.1997	RFC 58 LZK (a)	A11	B29	0,9	F54
	2.0 i 16V	RFT (XU10J4-Z), RFY	110-112/150-152	07.1992	06.1997	RFN 58 LZ (b)	A7	B28	0,9	F54
	2.0 i 16V	RFT (XU10J4-Z), RFY	110-112/150-152	07.1992	06.1997	RFN 58 LZ3A (g)	A515		0,9	
	2.0 i 16V	RFS (XU10J4RS-L3)	120/163	06.1996	06.1998	RFN 52 LZ	A27		0,7	F54
	2.0 i Volcane	RFS (XU10J4RS)	122/166	09.1996	10.1997	RFN 52 LZ	A27		0,7	F54
ZX Break	1.4, Break	KDZ (TU3M/Z)	55/75	03.1991	06.1995	RFC 52 LS	A3	B16	0,7	F54
	1.4, Break	KDZ (TU3M/Z)	55/75	07.1995	06.1997	RFN 52 LZ	A27		0,7	F54
	1.4 i, Break	KDX (TU3M/Z)/KDZ (TU3M/Z)/ KFX (TU3JP)	55/75	03.1991	06.1995	RFC 52 LS	A3	B16	0,7	F54
	1.4 i, Break	KDX (TU3M/Z)/KDZ (TU3M/Z)/ KFX (TU3JP)	55/75	07.1995	06.1997	RFN 52 LZ	A27		0,7	F54
	1.6 i, Break	BDY (XU5M)/BFZ (XU5JP)	65/88	03.1991	06.1997	RFN 52 LZ	A27		0,7	F54
	1.8 i 16V, Break	LFY (XU7JP4)	81/110	01.1996	06.1997	RFC 52 LS	A3	B16	0,7	F54
	1.8 i, Break	LFZ (XU7JP)	74/101	07.1992	06.1997	RFN 52 LZ	A27		0,7	F54
	1.9 i, Break	DKZ (XU9JA)	88/120	03.1991	06.1997	RFN 52 LZ	A27		0,7	F54
	2.0 i 16V, Break	RFS (XU10J4RS)	120/163	05.1996	06.1997	RFN 52 LZ	A27		0,7	F54
	2.0 i, Break	RFX (XU10J2C)	89/121	07.1992	06.1997	RFN 52 LZ	A27		0,7	F54
C15	1.0	TU9 [C1A]	33/45	07.1988	12.1997	RFC 58 LZK (a)	A11	B29	0,9	F54
	1.0	XV8 [108C]	33/45	11.1986	09.1988	C 62 LJS	A19	B2	0,6	J65
	1.1	109K/E1A	35/48	10.1984	07.1987	C 62 LJS	A19	B2	0,6	J65
	1.1	E1A [M103]	40/54	07.1987	09.1988	RFC 58 LZK (a)	A11	B29	0,9	F54
	1.1	1EA	40/54	10.1984	07.1987	C 62 LJS	A19	B2	0,6	J65
	1.1	TU1-K [H1A]	40/54	07.1988		RFC 58 LZK (a)	A11	B29	0,9	F54
	1.1	XW7 [109/5K]	35/48	10.1984	07.1987	C 62 LJS	A19	B2	0,6	J65
	1.1	109K/E1A	35/48	10.1984	12.1996	FN 52 LS	A41		0,8	F54
	1.1 i	HDZ (TU1M)	44/60	07.1988	06.1995	RFC 42 LZ2E	A5	B30	0,9	F54
	1.1 i	HDZ (TU1M)	44/60	07.1995	12.1996	RFC 58 LZ2	A54		1	F54
	1.3	G1A [M104]	48/65	07.1987	12.1997	RFC 58 LZK (a)	A11	B29	0,9	F54
	1.3	G1A [M104]	48/65	10.1984	06.1987	C 62 LJS	A19	B2	0,6	J65
	1.4	TU3TR [K3A]	51/69	07.1987	12.1997	RFC 58 LZK (a)	A11	B29	0,9	F54
	1.4	TU3TR [K3A]	51/69	07.1987	12.1997	RFN 58 LZ (b)	A7	B28	0,9	F54
	1.4	TU3.2-K [K2D] - TU3A [K1G]	55/75	07.1987	12.1997	RFC 58 LZK (a)	A11	B29	0,9	F54
	1.4	K1H (TU3A)	49/67	07.1987	12.1996	RFC 52 LS	A3	B16	0,7	F54
	1.4	TU3TR [K3A]	51/69	07.1987	12.1997	RFN 58 LZ3A (g)	A515		0,9	
	1.4	XY7 [150D]	44/60	10.1984	05.1988	C 62 LJS	A19	B2	0,6	J65
	1.4	XY7 [150D] - XY7CP [KAZ]	44/60	06.1988	12.1997	RFC 58 LZK (a)	A11	B29	0,9	F54
	1.4 E	150D (XY7)	44/60	05.1987	12.1996	C 62 LJS	A19	B2	0,6	J65
	1.4 i	KDY (TU3FM)/KDY (TU3M)	55/75	05.1991	06.1995	RFC 52 LS	A3	B16	0,7	F54
	1.4 i	KDY (TU3FM)/KDY (TU3M)	55/75	07.1995	12.1996	RFC 58 LZ2	A54		1	F54
	1.4 i	TU3M [KDY]	55/75	08.1991	12.1997	RFC 58 LZK (a)	A11	B29	0,9	F54
	1.4 i	TU3M [KDY]	55/75	08.1991	12.1997	RFN 58 LZ (b)	A7	B28	0,9	F54
	1.4 i	TU3M [KDY]	55/75	08.1991	12.1997	RFN 58 LZ3A (g)	A515		0,9	
C15 E	1.1	TU1M	35/48	07.1995		RFC 42 LZ2E	A5	B30	0,9	F54
C25 Bus (280_, 290_)	1.8	169 (XM7T)	50/68	11.1981	01.1994	C 62 LS	A4	B5	0,7	L65



(1) Available until end of stock

- (a) 30 000 km
- (b) 60 000 km
- (c) Grey sticker on ignition coil
- (d) Green sticker on ignition coil

- (e) Hex 21 mm
- (f) Hex 16 mm
- (g) Recommended for cold weather



kW/HP



Box
10

Blister
4



F3

CITROËN

	1.8 E	169 (XM7T)	51/69	07.1987	02.1994	C 62 LS	A4	B5	0,7	L65
	2.0	170C (XN1T)	62/84	02.1991	03.1994	RC 62 LS	A6	B17	0,7	L65
	2.0 E	170A, 170B (XN1T)	58/79	09.1981	02.1994	C 62 LS	A4	B5	0,7	L65
C25 Kasten (280_, 290_)	1.8	169 (XM7T)	50/68	11.1981	01.1994	C 62 LS	A4	B5	0,7	L65
	2.0		57/78	11.1981	12.1986	C 62 LS	A4	B5	0,7	L65
	2.0 E	170A, 170B (XN1T)	58/79	09.1981	02.1994	C 62 LS	A4	B5	0,7	L65
	2.0	170C (XN1T)	62/84	02.1991	03.1993	C 62 LS	A4	B5	0,7	L65
C25 Pritsche/Fahrgestell (280_, 290_)	2.0		57/78	11.1981	12.1986	C 62 LS	A4	B5	0,7	L65
	2.0	170C (XN1T)	62/84	01.1987	03.1994	C 62 LS	A4	B5	0,7	L65
C35 Bus	2.0	B20614	65/88	11.1973	01.1994	C 42 S	A12	B7	0,6	N43
C35 Kasten	2.0	B20614	65/88	11.1973	01.1994	C 42 S	A12	B7	0,6	N43
C35 Pick-up	2.0	B20614	65/88	11.1973	01.1994	C 42 S	A12	B7	0,6	N43
H	850,					C 42 S	A12	B7	0,6	N43
	1000, 1.0					C 42 S	A12	B7	0,6	N43
	1500,					C 42 S	A12	B7	0,6	N43
	1600, 1.6					C 42 S	A12	B7	0,6	N43

DACIA

1210	1.2	810-02/99	37/50	01.1977		C 42 S	A12	B7	0,6	N43
1410	1.4		48/65	01.1977		C 42 S	A12	B7	0,6	N43
1300 > 1325	1.3 / 1.4			01.1977		C 42 S	A12	B7	0,75	N43
	1.3 i / 1.4 i / 1.6 i			01.1983		RC 42 S	A69	B23	0,75	N43
DOKKER	NEW 1.2 TCe	H5F 402	84/114	11.2012		RWN 42 HSIPS	A542		0,75	
	1.6	K7M 812/K7M828	61/83	11.2012		RFC 58 LZ2E	A10	B31	0,9	F54
	NEW 1.6	H4M 738	75/102	04.2015		RWC 58 HSEW	A530		0,9	
	1.6 MPI	K7M 800	62/84	11.2012		RFC 58 LZ2E	A10	B31	0,8	F54
	1.6 LPG	K7M 812/K7M828	61/83	11.2013		RFC 58 LZ2E	A10	B31	0,8	F54
DOKKER Express	NEW 1.2 TCe 115	H5F 402	85/115	12.2012		RWN 42 HSIPS	A542		0,75	
	NEW 1.6	H4M 738	75/102	04.2015		RWC 58 HSEW	A530		0,9	
	1.6 16V	K7M 812/K7M 828	61/83	12.2012		RFC 58 LZ2E	A10	B31	0,9	F54
	NEW 1.6 LPG	K7M 812/K7M 828	61/83	11.2013		RFC 58 LZ2E	A10	B31	0,8	F54
DUSTER	1.4 Duster 4x4		48/65	06.1984		C 42 S	A12	B7	0,6	N43
	NEW 1.2 TCe 125, 4x4	H5F 404	92/125	10.2013		RWN 42 HSIPS	A542		0,75	
	NEW 1.2 TCe 125 4x4	H5F 410	92/125	06.2015		RWN 42 HSIPS	A542		0,75	
	1.6 16V	K4M 696/K4M 690	77/105	04.2010		RFN 58 LZ (b)	A7	B28	0,9	F54
	1.6 16V	K4M 696/K4M 690	77/105	04.2010		RFN 58 LZ3A (g)	A515		0,9	
	NEW 1.6 16V Hi-Flex	K4M 696	77/105	08.2010		RFC 58 LZ2E	A10	B31	0,9	F54
	1.6 16V LPG	K4M 696	77/105	04.2011		RFN 58 LZ (b)	A7	B28	0,9	F54
	1.6 16V LPG	K4M 696	77/105	04.2011		RFN 58 LZ3A (g)	A515		0,9	
	1.6 16V 4x4	K4M 606	77/105	06.2010		RFN 58 LZ (b)	A7	B28	0,9	F54
	1.6 16V 4x4	K4M 606	77/105	06.2010		RFN 58 LZ3A (g)	A515		0,9	
	NEW 1.6 SCe 115	H4M 738	84/115	06.2015		RWC 58 HSEW	A530		0,9	
	NEW 1.6 SCe 115 4x4	H4M 730	84/115	06.2015		RWC 58 HSEW	A530		0,9	
DUSTER Camionnette	NEW 1.2 TCe 125 4x4	H5F 404	92/125	10.2013		RWN 42 HSIPS	A542		0,75	
	NEW 1.6 SCe 115	H4M 738	84/115	06.2015		RWC 58 HSEW	A530		0,9	
	NEW 1.6 SCe 115 4x4	H4M 730	84/115	06.2015		RWC 58 HSEW	A530		0,9	
	NEW 1.6 16V Hi-Flex	K4M 696	77/105	04.2011		RFN 58 LZ (b)	A7	B28	0,9	F54
	1.6 16V Hi-Flex	K4M 696	77/105	04.2011		RFN 58 LZ3A (g)	A515		0,9	
	NEW 1.6 16V	K4M 606	77/105	04.2011		RFN 58 LZ (b)	A7	B28	0,9	F54
	1.6 16V	K4M 606	77/105	04.2011		RFN 58 LZ3A (g)	A515		0,9	
LODGY	NEW 1.2 TCe	H5F 402	85/115	03.2012		RWN 42 HSIPS	A542		0,75	
	1.6	K7M 812-828	61/83	03.2012		RFC 58 LZ2E	A10	B31	0,9	F54
	1.6 LPG	K7M 812-828	61/83	11.2013		RFC 58 LZ2E	A10	B31	0,9	F54
	NEW 1.6 LPG	H4M 740	75/102	04.2015		RWC 58 HSEW	A530		0,9	
	NEW 1.6 SCe 115	H4M 740	84/115	06.2015		RWC 58 HSEW	A530		0,9	
LOGAN	1.2 16V	D4F 732	55/75	02.2006		RWC 52 HSK	A197	B58	0,9	
	NEW 1.2 16V LPG	D4F 734	55/75	02.2006		RWC 58 HSEW	A530		0,9	
	1.4	K7J 710	55/75	09.2004		RFC 58 LZ2E	A10	B31	0,9	F54
	1.4 MPI LPG	K7J 710-714	55/75	02.2006		RFC 58 LZ2E	A10	B31	0,9	F54
	1.6 MPI	K7M 800	62/84	05.2010		RFC 58 LZ2E	A10	B31	0,9	F54
	1.6 Bifuel	K7M 718	62/84	05.2010		RFC 58 LZ2E	A10	B31	0,9	F54
	1.4 i - 1.6 i	K7J - K7M	55/75 - 66/90	10.2004		RFC 58 LZ2E	A10	B31	0,9	F54
	1.6	K7M 710	64/87	09.2004		RFC 58 LZ2E	A10	B31	0,9	F54

(1) Available until end of stock

(a) 30 000 km

(b) 60 000 km

(c) Grey sticker on ignition coil

(d) Green sticker on ignition coil

(e) Hex 21 mm

(f) Hex 16 mm

(g) Recommended for cold weather

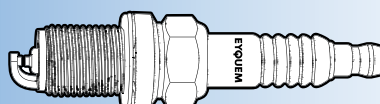

EYQUEM



Box
10

Blister
4



F3→1

DACIA										
	1.6 i 16V	K4M 690-694	77/105	09.2005		RFN 58 LZ (b)	A7	B28	0,7	F54
	1.6 i 16V	K4M 690-694	77/105	09.2005		RFN 58 LZ3A (g)	A515		0,7	
LOGAN II	NEW TCe 90	H4B 400	66/90	10.2012		RWN 42 HSIPS	A542		0,75	
	NEW 1.0 SCe 75	B4D 400-401	54/73	01.2017		RWC 42 HSEW	A555		0,9	
	NEW 1.2 16V	D4F 732	54/73	05.2015		RWC 58 HSEW	A530		0,9	
	NEW 1.2 16V	D4F 732	55/75	10.2012		RWC 58 HSEW	A530		0,9	
	NEW 1.2 16V LPG	D4F 734	55/75	10.2012		RWC 58 HSEW	A530		0,9	
	1.6 i 16V	K4M 842	77/105	01.2013		RFN 58 LZ (b)	A7	B28	0,7	F54
	1.6 i 16V	K4M 842	77/105	01.2013		RFN 58 LZ3A (g)	A515		0,7	
LOGAN EXPRESS	1.4	K7J 710	55/75	03.2009		RFC 58 LZ2E	A10	B31	0,9	F54
	1.6 MPI	K7M 800	62/84	05.2010		RFC 58 LZ2E	A10	B31	0,9	F54
	1.6 Bifuel	K7M 800	62/84	05.2010		RFC 58 LZ2E	A10	B31	0,9	F54
	1.6	K7M 710	64/87	03.2009		RFC 58 LZ2E	A10	B31	0,9	F54
LOGAN MCV	1.4	K7J 710	55/75	02.2007		RFC 58 LZ2E	A10	B31	0,9	F54
	1.6 MPI	K7M 800	62/84	05.2010		RFC 58 LZ2E	A10	B31	0,9	F54
	1.6 Bifuel	K7M 710	64/87	11.2008		RFC 58 LZ2E	A10	B31	0,9	F54
	1.6	K7M 710	64/87	02.2007		RFC 58 LZ2E	A10	B31	0,9	F54
	1.6 16V	K4M 696/K4M 690	77/105	02.2007		RFN 58 LZ (b)	A7	B28	0,9	F54
	1.6 16V	K4M 696/K4M 690	77/105	02.2007		RFN 58 LZ3A (g)	A515		0,9	
	1.6 Flexifuel	K4M 690/K4M 694	77/105	11.2009		RFN 58 LZ (b)	A7	B28	0,9	F54
	1.6 Flexifuel	K4M 690/K4M 694	77/105	11.2009		RFN 58 LZ3A (g)	A515		0,9	
LOGAN MCV II	NEW TCe 90	H4B 400	66/90	02.2013		RWN 42 HSIPS	A542		0,75	
	NEW 1.0 SCe 75	B4D 400-401	54/73	12.2016		RWC 42 HSEW	A555		0,9	
	NEW TCe 90 LPG	H4B 410	66/90	09.2015		RWN 42 HSIPS	A542		0,75	
	NEW 1.2	D4F 732	54/73	05.2015		RWC 58 HSEW	A530		0,9	
	NEW 1.2	D4F 732	55/75	02.2013		RWC 58 HSEW	A530		0,9	
	NEW 1.2 LPG	D4F 734	55/75	02.2013		RWC 58 HSEW	A530		0,9	
LOGAN Pick-up	1.4	K7J 710	55/75	01.2009		RFC 58 LZ2E	A10	B31	0,9	F54
	1.6 MPI 85	K7M 800	62/84	05.2010		RFC 58 LZ2E	A10	B31	0,9	F54
	1.6 Bifuel	K7M 800	62/84	05.2010		RFC 58 LZ2E	A10	B31	0,9	F54
	1.6	K7M 710	64/87	03.2008		RFC 58 LZ2E	A10	B31	0,9	F54
NOVA-SUPERNOVA	1.4		48/65	01.1996		C 42 S	A12	B7	0,75	N43
	1.4 i	C		01.1996		RC 42 S	A69	B23	0,75	N43
	1.4 i	E7J	55/75	01.1996	03.2003	RFC 52 LS	A3	B16	0,8	F54
	1.6 i	C	53/72	05.1996		RC 42 S	A69	B23	0,75	N43
SANDERO	1.2 16V	D4F 732	55/75	11.2008		RWC 52 HSK	A197	B58	0,9	
	NEW 1.2 16V	D4F 732	55/75	10.2012		RWC 58 HSEW	A530		0,9	
	NEW 1.2 16V LPG	D4F 732	55/75	11.2008		RWC 58 HSEW	A530		0,9	
	1.4	K7J 710	55/75	06.2008		RFC 58 LZ2E	A10	B31	0,9	F54
	1.4 MPI	K7J 710	55/75	06.2008		RFC 58 LZ2E	A10	B31	0,9	F54
	1.4 MPI GPL	K7J 714	53/72	01.2009		RFC 58 LZ2E	A10	B31	0,9	F54
	1.6	K7M 710	64/87	06.2008		RFC 58 LZ2E	A10	B31	0,9	F54
	1.6 16V 105Ch	K4M 690	77/105	06.2008		RFN 58 LZ (b)	A7	B28	0,9	F54
	1.6 16V 105Ch	K4M 690	77/105	06.2008		RFN 58 LZ3A (g)	A515		0,9	
	1.6 16V Bifuel	K4M 690-694-696	77/105	01.2011		RFN 58 LZ	A7	B28	0,9	F54
	1.6 MPI	K7M 710	67/91	06.2008		RFC 58 LZ2E	A10	B31	0,9	F54
	1.6 MPI 85	K7M 800	62/84	05.2010		RFC 58 LZ2E	A10	B31	0,9	F54
SANDERO II	NEW TCe 90	H4B 400	66/90	10.2012		RWN 42 HSIPS	A542		0,75	
	NEW 1.0 SCe 75	B4D 400-401	54/73	12.2016		RWC 58 HSEW	A530		0,9	
	NEW 1.2	D4F 732	54/73	05.2015		RWC 58 HSEW	A530		0,9	
	NEW 1.2	D4F 732	55/75	10.2012		RWC 58 HSEW	A530		0,9	
	NEW 1.2 LPG	D4F 732	55/75	10.2012		RWC 58 HSEW	A530		0,9	
	NEW 1.6	K7M 812	61/83	11.2012		RFC 58 LZ2E	A10	B31	0,9	F54
	1.6 16V	K4M 842/845	77/105	01.2013		RFN 58 LZ (b)	A7	B28	0,9	F54
	1.6 16V	K4M 842/845	77/105	01.2013		RFN 58 LZ3A (g)	A515		0,9	
SOLENZIA	1.4 i	E7J		01.1996		RFN 58 LZ (b)	A7	B28	0,9	F54
	1.4 i	K7J 710	55/75	02.2003		RFC 58 LZ 2E	A10	B31	0,9	F54
DAEWOO										
ARANOS	1.8 i	[SOHC]	70/95	11.1994		RC 52 LS	A9	B20	0,9	L65
	2.0 i		81/110	11.1994		RC 32 LS5	A110		0,9	
CIELO	1.5 i	G15MF [SOHC]	51-55-58/70-75-79	08.1994		RC 52 LS	A9	B20	0,8	L65
	1.5 i 16V	A15MF [DOHC]	66-74/90-100	08.1994		RFC 52 LS5	A26	B24	1,1	F54-5
DAMAS	0.8	F8CB	28/38	10.1991	04.1993	RC 52 LS	A9	B20	0,8	L65
ESPERO	1.5 i	G 15 MF	55-66/75-90	04.1993		RC 52 LS	A9	B20	0,8	L65

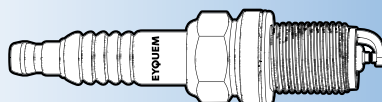

- (1) Available until end of stock
- (a) 30 000 km
- (b) 60 000 km
- (c) Grey sticker on ignition coil
- (d) Green sticker on ignition coil

- (e) Hex 21 mm
- (f) Hex 16 mm
- (g) Recommended for cold weather



kW/HP

Box
10Blister
4

F3-D1

DAEWOO

	1.5 i 16V CLX, GLX, GLX Pack L	A15MF [DOHC]	66/90	09.1993		RFC 52 LS5	A26	B24	1,1	F54-5
	1.8 i CD	C 18 NE [OHC]	66-70/90-95	09.1993		RC 52 LS	A9	B20	0,8	L65
	2.0		74/101	10.1991	09.1993	RC 32 LS	A49	B19	0,7	L3
	2.0	C20LE	77/105	02.1995	06.1999	RC 32 LS	A49	B19	0,7	L3
	2.0 i CD, CD Pack L	C 20 LE - LZ	77/105	10.1990		RC 52 LS5	A36	B38	1,1	L65-5
IMPERIAL	3.0 i	C 30 NE	135/184	02.1989	08.1993	RC 42 S	A69	B23	0,7	N43
KALOS	1.2		53/72	04.2003	01.2005	RC 52 LS5	A36	B38	0,7	L65-5
	1.4		61/83	09.2002		RC 62 LS	A6	B17	0,7	L65
	1.4 16V		69/94	04.2003	01.2005	RFC 52 LS5	A26	B24	0,7	F54-5
KORANDO	2.0 16V Cabrio		94/128	02.1999		FC 42 LS	A15	B14	0,8	F54
	2.3		105/143	01.1999		FC 42 LS	A15	B14	0,8	F54
	2.3 Cabrio		105/143	02.1999		FC 42 LS	A15	B14	0,8	F54
	3.2	M 104.995	162/220	01.1999		FC 42 LS	A15	B14	0,8	F54
LACETTI	1.4		70/95	02.2004		RFC 52 LS5	A26	B24	0,7	F54-5
	1.6		80/109	02.2004		RFC 52 LS5	A26	B24	0,7	F54-5
LANOS	1.4 i	A14SMS [SOHC]	55/75	04.1997		RC 62 LS	A6	B17	0,8	L65
	1.5 i SE, SX	A15SMS [SOHC]	63/86	11.1996		RC 62 LS	A6	B17	0,8	L65
	1.6 16V	A16DMS	78/106	05.1997		RFC 42 LS5	A83		0,7	F54-5
	1.6 i 16V	A16DMS [DOHC]	78/106	11.1996		RFC 58 LS5	A38	B48	1,1	F54-5
LE MANS	1.5	G 15 CF	63-65/85-88	01.1988	12.1991	RC 52 LS	A9	B20	0,7	L65
	1.5 i	G 15 SF - MF	55-66/75-90	09.1988	03.1994	RC 52 LS	A9	B20	0,7	L65
	1.5 i 16V	A15MF [DOHC]	73/99	04.1993	10.1996	RFC 58 LS5	A38	B48	1,1	F54-5
	1.6 i	G 16 SF	68/92	01.1988	03.1993	RC 52 LS	A9	B20	0,7	L65
	2.0 i	C 20 LZ	73/99	01.1990	03.1993	RC 52 LS5	A36	B38	1,1	L65-5
LEGANZA	2.0 16V	X20SED	98/133	06.1997	12.2002	RFN 52 LZ	A27		0,7	F54
	2.0 i 16V CDX, SX	X20SED [DOHC]	98-100/133-136	03.1997		RFC 42 LZ2E	A5	B30	1,0	F54
LEGEND	3.2			09.1993		RFC 62 LS5	A42		1,1	F54-5
MATIZ	0.8 i S, SE	F8CV	37/50	04.1998		RC 52 LS5	A36	B38	1,1	L65-5
	1.0		47/64	01.2003		RC 52 LS5	A36	B38	1,1	L65-5
MUSSO	2.3	M 111.970	103/140	01.1999		FC 42 LS	A15	B14	0,8	F54
	3.2	M 104.992	162/220	01.1999		FC 42 LS	A15	B14	0,8	F54
NEXIA	1.5 16V	A15MF	66/90	02.1995	08.1997	RFC 42 LS5	A83		0,7	F54-5
	1.5 i 16V GLX, GTX	A15MF [DOHC]	66/90	11.1994		RFC 52 LS5	A26	B24	1,1	F54-5
	1.5 i Aquarius, GL, GLE	G15MF [SOHC]	55/75	12.1994		RC 52 LS	A9	B20	0,8	L65
	1.8 i	C 18 LE [SOHC]	74/101	12.1995		RC 62 LS	A6	B17	0,8	L65
NUBIRA	1.6 16V	A16DMS	78/106	05.1997		RFC 42 LS5	A83		0,7	F54-5
	1.6 16V	A16DMS	78/106	05.1997		RFC 42 LS5	A83		0,7	F54-5
	1.6 i 16V SE, SX	A16DMS [DOHC]	78/106	06.1997		RFC 58 LS5	A38	B48	1,1	F54-5
	2.0 16V	X20SED	98/133	05.1997		RFN 52 LZ	A27		0,7	F54
	2.0 i 16V CDX	X20SED [DOHC]	98-100/133-136	04.1997		RFC 42 LZ2E	A5	B30	1,0	F54
PRINCE	1.8 i	C 18 LE	78/106	09.1992	03.1996	RC 32 LS5	A110		1,0	
	1.8 i 16V	[DOHC]	101/137	04.1996	02.1997	RFC 42 LZ2E	A5	B30	1,0	F54
	2.0 i 16V Brougham	T20 [DOHC]	106/144	01.1996	02.1997	RFC 42 LZ2E	A5	B30	1,0	F54
	2.0 i Brougham, Super Salon	C 20 LE	81-85/110-115	01.1991	03.1996	RC 52 LS5	A36	B38	1,1	L65-5
	2.2 i 16V	[DOHC]	109/148	01.1996	02.1997	RFC 42 LZ2E	A5	B30	1,0	F54
RACER	1.5 i			01.1988	02.1993	RC 52 LS	A9	B20	0,8	L65
REXTON	3.2 V6		162/220	04.2002		FC 42 LS	A15	B14	0,8	F54
REZZO	1.6		77/105	09.2000		RFC 42 LS5	A83		0,7	F54-5
ROYAL	1.5 i Prince	G 15 SR	55/75	01.1990	12.1990	RC 62 LS	A6	B17	0,7	L65
	1.5 Prince, Duke	G 15 CR	65/88	05.1987	12.1989	RC 62 LS	A6	B17	0,7	L65
	1.5 XQ	15 N	62/84	08.1982	05.1986	RC 42 S	A69	B23	0,7	N43
	1.9 i Prince	H 19 MR	78/106	01.1988	12.1990	RC 42 S	A69	B23	0,7	N43
	1.9 Prince	H 19 CR	78/106	09.1980	12.1987	RC 42 S	A69	B23	0,7	N43
	2.0 i Prince, Salon, Salon Super	H 20 MR	94/128	12.1985	12.1990	RC 42 S	A69	B23	0,7	N43
	2.0 Prince, Salon	H 20 CR	87/118	09.1980	12.1987	RC 42 S	A69	B23	0,7	N43
TACUMA / REZZO	2.0 i		77/105	01.2000		RC 52 LS	A9	B20	0,9	L65
	2.0 i 16V	T20 [DOHC]	100/136	01.2000		RFC 42 LZ2E	A5	B30	1,0	F54
TICO	0.8 SX	F8C	30/41	06.1991		RC 52 LS5	A36	B38	1,1	L65-5

DAF

V 200	1.7	Leyland-Daf	52/71	03.1988		C 62 LS	A4	B5	0,7	L65
	2.0	Leyland-Daf	67/91	03.1988		C 72 LS (1)	A30		0,7	L87

(1) Available until end of stock

(a) 30 000 km

(b) 60 000 km

(c) Grey sticker on ignition coil

(d) Green sticker on ignition coil

(e) Hex 21 mm

(f) Hex 16 mm

(g) Recommended for

cold weather



EYQUEM



Box 10
Blister 4



DAIHATSU

APPLAUSE	1.6 16V	HD-C [SOHC]	63/86		12.1991	RFC 58 LS5	A38	B48	1,1	F54-5
	1.6 i	HD-CF	66/90	06.1989	08.1997	RFC 58 LS5	A38	B48	1,1	F54-5
	1.6 i 16V 4x4	HD-E Cat	66-77/90-105	06.1989		RFC 52 LS5	A26	B24	1,1	F54-5
APPLAUSE II	1.6 16V	HD-E	73/99	07.1997	05.2000	RFC 52 LS5	A26	B24	1,1	F54-5
ARTEZ	2.2 i 16V	5S-FE [DOHC] Cat	100/136	03.2000		RFC 58 LS5	A38	B48	1,1	F54-5
CHARADE	1.0 CS, CX	CB 36/37	40/54	01.1987	01.1993	RC 62 LS5	A24		1,1	L65-5
	1.0 GTi	CB 80	74/101	03.1987	12.1992	RFC 62 LS5	A42		0,7	F54-5
	1.0 i	CB20 - CB23 [OHC] Cat	40/54	10.1977		RC 52 LS5	A36	B38	1,1	L65-5
	1.0 i	CB90	40/54	11.1989		RC 62 LS5	A24		1,1	L65-5
	1.0 i GTi	CB70	74/101	03.1987	01.1993	RC 62 LS5	A24		1,1	L65-5
	1.0 i Turbo GTi Twin Cam Turbo	CB80 [DOHC]	74-77/100-105	03.1987	09.1991	C 62 LS3X	A13	B15	0,8	L65
	1.0 Turbo	CB23 - CB 60/61	50/68	10.1983	10.1990	RC 62 LS	A6	B17	0,8	L65
	1.3 i 16V	HC-C [DOHC] - HC-E [SOHC]	66/90	09.1988	12.1992	RFC 52 LS5	A26	B24	1,1	F54-5
	1.3 i 4x4	HC-E [OHC] Cat	66/90	06.1988	10.1990	RFC 52 LS5	A26	B24	1,1	F54-5
	1.5 i 16V	HE-E [SOHC] Cat	55-66/75-90	08.1993	03.2000	RFC 58 LS5	A38	B48	1,1	F54-5
	1.6 i 16V GTi	HD-E Cat	77/105	01.1993	03.2000	RFC 58 LS5	A38	B48	1,1	F54-5
CHARMANT	1.3	4K - 4K-C	48-55/65-75	03.1978	07.1987	RC 52 LS	A9	B20	0,8	L65
	1.4	T	63/86	11.1973	07.1981	RC 52 LS	A9	B20	0,8	L65
	1.6	2T - 4A - 12T	56-65/76-88	03.1978	07.1987	RC 52 LS	A9	B20	0,8	L65
	1.6	3AU	56/76	01.1982	12.1988	RC 52 LS5	A36	B38	1,1	L65-5
CONSORTE				01.1970	12.1979	RC 62 LS	A6	B17	0,9	L65
COPEL	1.3	K3 VE	64/87	03.2006		RFC 58 LZ5	A101		1,1	F54-5
CUORE	660	EF-CL		01.1990		RC 62 LS	A6	B17	0,8	L65
	660	EF-HL [SOHC]		01.1990		RFC 52 LS	A3	B16	0,8	F54
	0.5 550, Max	AB10	21/29	01.1976	09.1980	RC 62 LS	A6	B17	0,8	L65
	0.5 L55	AB30	20/27	10.1980	08.1985	RC 62 LS	A6	B17	0,8	L65
	0.55 Turbo	EB-T		01.1988		RC 72 LS	A32	B26	0,8	L87
	0.6 L60	AD10	22/30	10.1980	08.1985	RC 62 LS	A6	B17	0,8	L65
	0.8 850, 850 4x4	ED Cat	30-32/41-44	08.1985	07.1994	RC 62 LS	A6	B17	0,8	L65
	0.8 i 12V 850	ED20	31/42	01.1995		RC 62 LS	A6	B17	0,8	L65
	0.8 i 6V 850, 850 4x4	ED10 [SOHC]	29-32/39-44	08.1985	07.1994	RC 62 LS	A6	B17	0,8	L65
	0.9 900	Cat	31/42	11.1996		RC 62 LS5	A24		1,1	L65-5
	1.0 i	EJDE	41/56	10.1998	05.2003	RFC 42 LS5	A83		0,7	F54-5
	1.0	1KR-FE	51/69	04.2007		RFC 58 HZEDP5	A191		1,1	
DELTA	1.2	3K-J		12.1975	02.1978	C 62 LS	A4	B5	0,8	L65
	1.3 Wide	4K-J		01.1978	10.1988	C 62 LS	A4	B5	0,8	L65
	1.5 i Wide	5K-J		08.1990	12.1991	RC 52 LS	A9	B20	0,8	L65
	1.8 Wide	2Y-U [OHV]	58/79	11.1982	12.1991	RC 52 LS5	A36	B38	1,1	L65-5
	1.8 Wide	2Y-J [OHV]	58/79	08.1988	11.1996	RC 52 LS	A9	B20	0,8	L65
	2.0 V69B-U	3Y	63/86	10.1986		RC 62 LS	A6	B17	0,9	L65
DELTA WAGON / VAN	1.5 i	5K-J		11.1996		RC 52 LS	A9	B20	0,8	L65
	1.8 i	7K		11.1996	12.1999	RC 52 LS	A9	B20	0,8	L65
	1.8 i	7K-E		01.2000		RC 52 LS5	A36	B38	1,1	L65-5
	2.0 i 16V	3S-FE [DOHC] Cat	94/128	11.1996		RFC 58 LZ5	A101		1,1	F54-5
DOMINO	0.8	ED Cat	32/44	09.1985		RC 62 LS	A6	B17	0,9	L65
	0.8 i 12V	ED20	31/42	10.1996		RC 62 LS	A6	B17	0,9	L65
	0.8 i 6V	ED10 [SOHC]	31/42	09.1985		RC 62 LS	A6	B17	0,9	L65
	1.0 L			07.1993		RC 62 LS	A6	B17	0,9	L65
F	1.6 20/25	12R	49/67	09.1976	12.1984	RC 52 LS	A9	B20	0,8	L65
	2.0 80/85	3Y	64/87	04.1984		RC 52 LS	A9	B20	0,8	L65
FEROZA	1.6 16V 4x4	HD-C [SOHC]	63/86	10.1988		RFC 58 LS5	A38	B48	1,1	F54-5
	1.6 i 16V 4x4	HD-E Cat	70/95	08.1988		RFC 58 LS5	A38	B48	1,1	F54-5
GRAN MOVE	1.5 i 16V	HE-E [SOHC] Cat	55-66-71/75-90-97	08.1996		RFC 58 LS5	A38	B48	1,1	F54-5
	1.6 16V	HDEP	67/91	05.1998		RFC 52 LS5	A26	B24	0,7	F54-5
HI ATRE 7	1.3 i 16V	K3-VE [DOHC] Cat		07.2000		RFC 58 LZ5	A101		1,1	F54-5
HIJET	0.55 Climber, Jumbo	EB 60	23/31	09.1987	04.1990	RC 62 LS	A6	B17	0,8	L65
	0.55 HiJet, HiAtre	EB 60	23/31	09.1987	10.1988	RC 62 LS	A6	B17	0,8	L65
	0.55 HiJet, HiAtre	EB	23/31	10.1988	04.1990	RC 62 LS	A6	B17	0,8	L65
	0.8 850	CD		07.1986	11.1992	RC 52 LS	A9	B20	0,8	L65
	1.0 1000	CB	33/45	12.1992		RC 62 LS	A6	B17	0,8	L65
	1.0 1000, 1000 4x4	CB	33/45	07.1986	11.1992	RC 52 LS	A9	B20	0,8	L65
	1.0 i	CB42	35/48	07.1994	05.1998	RC 52 LS5	A36	B38	0,7	L65-5
	1.3 i 16V		48/65	05.1998		RFC 52 LS5	A26	B24	0,7	F54-5
	660 i	EF-SE		01.1999		RFC 58 LS5	A38	B48	1,1	F54-5
LEEZA	660	EF-HL [SOHC]		08.1990	12.1992	RFC 52 LS	A3	B16	0,8	F54

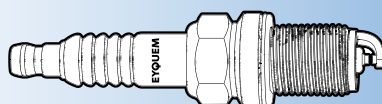

(1) Available until end of stock

- (a) 30 000 km
- (b) 60 000 km
- (c) Grey sticker on ignition coil
- (d) Green sticker on ignition coil

- (e) Hex 21 mm
- (f) Hex 16 mm
- (g) Recommended for cold weather



Box
10 Blister
4



F3-D1

DAIHATSU

	0.55	EB	23/31	12.1986	08.1990	RC 62 LS	A6	B17	0,7	L65
MIDGET	660 i	EF-CK		04.1996		RC 52 LS	A9	B20	0,8	L65
MATERIA	1.5	3SZ-VE	76/103	10.2006		RZC 58 LS	A190	B59	0,9	
	1.5 ECO 4WD	3SZ-VE	76/103	10.2006		RZC 58 LS	A190	B59	0,9	
MIRA	660	EF-KL		03.1990	09.1994	RC 52 LS5	A36	B38	1,1	L65-5
	660	EF-CL		03.1990	09.1994	RC 62 LS	A6	B17	0,9	L65
	660	EF-HL [SOHC]		03.1990	09.1994	RFC 52 LS	A3	B16	0,8	F54
	660	EF-FL [SOHC]		09.1994	10.1998	RC 52 LS	A9	B20	0,8	L65
	0.5 Turbo Mira Turbo	AB	30/41	10.1980	08.1985	C 62 LS	A4	B5	0,8	L65
	0.6 Mira 4x4	AB	22/30	10.1980	09.1985	C 62 LS	A4	B5	0,8	L65
	0.8 i 6V	ED10 [SOHC]	31/42	11.1990		RC 62 LS	A6	B17	0,9	L65
	660 i	EF-SE		10.1998		RFC 58 LS5	A38	B48	1,1	F54-5
MOVE	0.8		31/42	10.1996		RC 62 LS5	A24		0,7	L65-5
	0.8 i 12V 850	ED20	31/42	01.1997		RC 52 LS5	A36	B38	1,1	L65-5
	0.8 i 6V 850	ED10 [SOHC]	31/42	01.1997		RC 52 LS5	A36	B38	1,1	L65-5
	1.0 i	EJDE	41/56	10.1998	09.2000	RFC 52 LS5	A26	B24	0,7	F54-5
	660 i	EF-SE		10.1998		RFC 58 LS5	A38	B48	1,1	F54-5
	660 i Turbo	JB-DET [DOHC] Cat	47/64	10.1998		RFC 58 LZ2	A54		1,0	F54
OPTI	660	EF-KL		08.1992	12.1998	RC 52 LS5	A36	B38	1,1	L65-5
	660 i	EF-SE		12.1998		RFC 58 LS5	A38	B48	1,1	F54-5
	660 i Turbo	JB-DET [DOHC] Cat	47/64	12.1998		RFC 58 LZ2	A54		1,0	F54
PYZAR	1.5 i 16V	HE-EG Cat	66/90	08.1996		RFC 58 LS5	A38	B48	1,1	F54-5
	1.6 i 16V	HD-EP Cat	85/115	09.1997		RFC 58 LS5	A38	B48	1,1	F54-5
ROCKY	1.6 i 16V	HD-E Cat	77/105	06.1990	04.1997	RFC 58 LS5	A38	B48	1,1	F54-5
	2.0 i 4x4	3Y	63-67/86-91	03.1987	04.1993	RC 52 LS	A9	B20	0,8	L65
	2.2 i 4x4	4Y	67-69/91-94	05.1993		RC 52 LS	A9	B20	0,8	L65
SIRION	1.0 i 12V	EJ-DE Cat	40/54	04.1998		RFC 58 LZ2	A54		1,0	F54
	1.0 i, 4WD	EJDE	41/56	04.1999	09.2000	RFC 52 LS5	A26	B24	0,7	F54-5
	1.0 i, 4WD	EJ-VE	43/58	09.2000	01.2005	RFC 52 LS5	A26	B24	0,7	F54-5
	NEW 1.0	1KR-FE	51/69	01.2005		RFN 58 HZ5	A534			1.15
	1.3 i 16V, Gtvi	K3-VE [DOHC] Cat		09.2000		RFC 58 LZ5	A101		1,1	F54-5
	1.3 Sport, 4WD	K3-VE2	75/102	08.2000	01.2005	RFC 58 LZ3EX	A58	B55	0,7	F54
	1.5	3SZ-VE	76/103	03.2008		RZC 58 LS	A190	B59	0,9	
SPARCAR	0.5 550 S60, S65	AB20		03.1977	08.1989	C 62 LS	A4	B5	0,8	L65
	0.9 S70	CD20		09.1983	08.1989	RC 62 LS	A6	B17	0,8	L65
	1.0 1000, S 75 V	CB41	33/45	01.1985		RC 52 LS	A9	B20	0,9	L65
STORIA	1.0 i 12V	EJ-DE Cat	40/54	02.1998	05.2000	RFC 58 LZ2	A54		1,0	F54
	1.0 i 12V	EJ-VE [DOHC] Cat		05.2000		RFC 58 LZ5	A101		1,1	F54-5
	1.3 i 16V	K3-VE [DOHC] Cat		05.2000		RFC 58 LZ5	A101		1,1	F54-5
TAFT	1.6 4x4	12R	49/67	01.1976	05.1984	RC 52 LS	A9	B20	0,8	L65
TERIOS	1.0	EJ-VE	43/58	06.2006		RFC 58 LZ2	A54		1,0	F54
	1.3 i 16V	HC-EJ	61/83	03.1997	05.2000	RFC 58 LZ2	A54		1,0	F54
	1.3 i 16V	K3-VE [DOHC] Cat		05.2000		RFC 58 LZ5	A101		1,1	F54-5
	1.3, 4WD	HE-EJ	61/83	10.1997	10.2000	RFC 58 LZK (a)	A11	B29	0,8	F54
	1.3, 4WD	K3-VE	63/86	10.2000		RFC 58 LZK (a)	A11	B29	0,8	F54
	1.5	3SZ-VE	77/105	11.2005		RZC 58 LS	A190	B59	0,9	
	1.5 4WD	3SZ-VE	77/105	05.2006		RZC 58 LS	A190	B59	0,9	
VALERA	1.5 i 16V	HE-EG Cat	66/90	01.1995		RFC 58 LS5	A38	B48	1,1	F54-5
WILDCAT - ROCKY	2.8 D	DL	54/73	02.1985	03.1987	C 62 LS	A4	B5	0,7	L65
YRV	1.0	EJ-VE	43/58	02.2001		RFN 52 LZ	A27		0,7	F54
	1.0 i 12V	EJ-VE [DOHC] Cat		08.2000		RFC 58 LZ5	A101		1,1	F54-5
	1.3 i 16V	K3-VE [DOHC] Cat		08.2000		RFC 58 LZ5	A101		1,1	F54-5
	1.3, 4WD	K3-VE	64/87	02.2001		RFC 58 LZ3EX	A58	B55	0,7	F54

DAIMLER LTD

DAIMLER (X300)	Six	BC	209/284	07.1997	08.2002	RFC 52 LS	A3	B16	0,7	F54
	Six	9JPF RB	177/241	09.1994	10.1998	RFC 52 LS	A3	B16	0,7	F54
DS	4.2 i L6 420	[OHC]	131/178	10.1984		C 52 LS	A1	B1	0,6	L65
	4.2 L6 420	[OHC]	123/167	10.1984		C 52 LS	A1	B1	0,6	L65
SOVEREIGN	3.4	XK [OHC]	120/163	09.1974	08.1986	C 52 LS	A1	B1	0,9	L65
	3.6			01.1986	12.1989	RFC 58 LS	A18		0,9	F54
	4.0	AJ6 [DOHC] Cat	163-175/222-238	09.1989		RFC 58 LS	A18		0,9	F54
	4.2 L6	[OHC]	150/204	03.1979		C 62 LS	A4	B5	0,6	L65

(f) Available until end of stock

(a) 30 000 km

(b) 60 000 km

(c) Grey sticker on ignition coil

(d) Green sticker on ignition coil

(e) Hex 21 mm

(f) Hex 16 mm

(g) Recommended for cold weather



EYQUEM



Box
10

Blister
4



F3

DE LOREAN

DMC-12	2.8	PRV		10.1982	RC 72 LJS3	A80		1,2	
--------	-----	-----	--	---------	------------	-----	--	-----	--

DINO

308	3.0 GT4			08.1973	12.1981	C 82 LS	A40	B6	0,6	L87
-----	---------	--	--	---------	---------	---------	-----	----	-----	-----

DODGE

600	2.2 i			01.1986	12.1988	RC 30 LS	A109		0,9	
	2.5 i	(K)	74/101	01.1986	12.1988	RC 30 LS	A109		0,9	
ARIES	2.2 i	(D)		01.1986	12.1989	RC 30 LS	A109		0,9	
	2.5 i	(K)	74/101	01.1986	12.1989	RC 30 LS	A109		0,9	
AVENGER	2.0 i	(Y) [DOHC]	104/141	09.1994	08.1996	RFC 42 LS	A25		1,2	F54
	2.5 i 24V	(H)	118/160	09.1994		RFC 42 LS5	A83		1,1	F54-5
CARAVAN	2.5 i		72/98	01.1988		RC 32 LS	A49	B19	0,9	L3
DAYTONA	2.2 i 16V Turbo IROC		167/227	08.1992		RC 52 LS	A9	B20	0,9	L65
	2.2 i Turbo			01.1986		RC 30 LS	A109		0,9	
	2.5 i Turbo			01.1986		RC 30 LS	A109		0,9	
	3.0 i V6	(3)	105/143	01.1990		RC 32 LS5	A110		1,1	
DYNASTY	2.5 i	(K)	74/101	09.1987	08.1993	RC 30 LS	A109		0,9	
	3.0 i V6	(3)	104/141	09.1987	08.1993	RC 32 LS5	A110		1,1	
GRAND CARAVAN	2.5 i SE		72/98	01.1988		RC 32 LS	A49	B19	0,9	L3
	3.0 i V6		104/141	01.1988		RC 32 LS5	A110		1,1	
KC	2.3					RC 32 LS	A49	B19	0,8	L3
LANCER	2.2 i Turbo	(A)	109/148	09.1986	08.1989	RC 32 LS	A49	B19	0,9	L3
	2.5 i	(K)	74/101	09.1986	08.1989	RC 32 LS	A49	B19	0,9	L3
MODELES IMP					12.1980	RC 62 LS	A6	B17	0,8	L65
OMNI	1.6	(A)				RC 30 LS	A109		0,9	
	2.2			01.1986	12.1987	RC 30 LS	A109		0,9	
	2.2 i			01.1986	12.1990	RC 30 LS	A109		0,9	
RAMCHARGER	5.2 i V8		156/212	01.1988	12.1991	RC 30 LS	A109		0,9	
	5.9 i V8	(W)		01.1989	12.1992	RC 30 LS	A109		0,9	
	5.9 i V8			01.1993		RC 30 LS	A109		0,9	
	5.9 V8	(W)				RC 30 LS	A109		0,9	
SERIES 1500- 2000-2500						RC 62 LS	A6	B17	0,8	L65
SERIES WALK-THRU						RC 30 LS	A109		0,8	
SHADOW	2.2 i ES	(D)	69/94	09.1986	08.1994	RC 30 LS	A109		0,9	
	2.5 i	(K)	74/101	08.1987	08.1994	RC 30 LS	A109		0,9	
	3.0 i V6	(3)	105/143	08.1992	08.1994	RC 32 LS5	A110		1,1	
SPACE VAN					RC 62 LS	A6	B17	0,8	L65	
SPIRIT	2.5 i Turbo 2.5 i LE, i Turbo		74-107/100-146	10.1988	08.1993	RC 32 LS5	A110		1,1	
	3.0 i V6	(3)	105/143	10.1988	08.1995	RC 30 LS	A109		1,1	
STEALTH	3.0 i Turbo	(K)	222/302	09.1992	08.1997	RFC 42 LS5	A83		1,1	F54-5
	3.0 i V6	(S)		01.1991		RC 32 LS5	A110		1,1	
	3.0 i V6			01.1991		RFC 42 LS	A25		0,9	F54
STRATUS	2.0 i 16V	ECB	98/133	01.1994		RFC 52 LS	A3	B16	0,8	F54
	2.5 i 24V	(H)	118/160	09.1994		RFC 42 LS5	A83		1,1	F54-5
	2.5 V6	EEB	125/170	12.1995		RFN 58 LZDP5	A187		1,1	

DS

DS 3	NEW 1.2 VTi 82	HMZ (EB2F)	60/82	04.2015		RZN 32 HSWDP	A531		1,0	
	NEW 1.2 THP 110	HNZ (EB2DT)	81/110	04.2015		RXN 72 HSIPFS	A541		0,75	
	NEW 1.2 THP 130	HNY (EB2DTS)	96/130	09.2015		RXN 72 HSIPFS	A541		0,75	
	1.6 THP	5GZ (EP6FDT)	120/163	07.2015		RXN 62 HSDP	A525		0,8	
	1.6 THP 165	5GZ (EP6FDT)	121/165	07.2015		RXN 62 HSDP	A525		0,8	
DS 3 cabrio	NEW 1.2 VTi 82	HMZ (EB2F)	60/82	07.2015		RZN 32 HSWDP	A531		1,0	
	NEW 1.2 THP 110	HNZ (EB2DT)	81/110	07.2015		RXN 72 HSIPFS	A541		0,75	
	NEW 1.2 THP 130	HNY (EB2DTS)	96/130	09.2015		RXN 72 HSIPFS	A541		0,75	
	1.6 THP	5GZ (EP6FDT)	120/163	07.2015		RXN 62 HSDP	A525		0,8	
	1.6 THP 165	5GZ (EP6FDT)	121/165	07.2015		RXN 62 HSDP	A525		0,8	
DS 4 / DS4 CROSSBACK	NEW 1.2 THP 130	HNY (EB2DTS)	96/130	07.2015		RXN 72 HSIPFS	A541		0,75	
	1.6 THP 165	5GZ (EP6FDT)	121/165	07.2015		RXN 62 HSDP	A525		0,8	
DS5	1.6 THP 165	5GZ (EP6FDT)	121/165	07.2015		RXN 62 HSDP	A525		0,8	

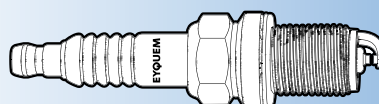

(1) Available until end of stock

- (a) 30 000 km
- (b) 60 000 km
- (c) Grey sticker on ignition coil
- (d) Green sticker on ignition coil

- (e) Hex 21 mm
- (f) Hex 16 mm
- (g) Recommended for cold weather



kW/HP



Box
10

Blister
4



F3-D1

FERRARI

308 GTS	2.9 i 2.9 GTB, i, GTS, i, Quattrovalvole	F106B - F105A	157-177/214-241	07.1981	08.1985	C 82 LS	A40	B6	0,6	L87
400 i	4.8 i iAuto.	F101C010		10.1976	04.1985	C 82 LS	A40	B6	0,6	L87
412 i	4.9 i V12			03.1985	12.1988	C 82 LS	A40	B6	0,8	L87
BB	512		250/340	08.1976	12.1981	C 82 LS	A40	B6	0,6	L87
MONDIAL	2.9		158/215	05.1980	06.1982	C 82 LS	A40	B6	0,6	L87

FIAT

124	1.4 Sport Coupé, Sport Spider					C 72 LS (1)	A30		0,7	L87
	1438 Special, Berlina, Familiare					C 62 LS	A4	B5	0,7	L65
	1.6 Abarth Rallye			01.1973	07.1975	C 82 LS	A40	B6	0,7	L87
	1.6 Sport Coupé, Sport Spider			11.1969	08.1973	C 72 LS (1)	A30		0,7	L87
	1.8 Sport Coupé, Sport Spider					C 72 LS (1)	A30		0,7	L87
	2.0 ie Sport Spider 2000 ie	131 AB...	77/105	06.1979	04.1985	RC 62 LS	A6	B17	0,7	L65
	2.0 Maratea			06.1983	12.1984	C 72 LS (1)	A30		0,7	L87
	2.0 Spider Europa Volumex		100/136	06.1983	04.1985	C 82 LS	A40	B6	0,7	L87
126	0.65 650	Lg filetage		07.1977	09.1987	C 42 S	A12	B7	0,7	N43
	0.7 Bis, Up	126 A2...		09.1987	06.1992	RC 62 LS	A6	B17	0,7	L65
127	0.9 900 Brava, C, L, Spécial, Super			06.1971	05.1985	RC 62 LS	A6	B17	0,7	L65
	1.05 1050 C, CL, Panorama, Super, Top			04.1977	12.1986	RC 62 LS	A6	B17	0,7	L65
	1.05 1050 Sport			06.1978	05.1985	RC 72 LS	A32	B26	0,7	L87
	1.3 1300 Sport			06.1978	05.1985	C 62 LS	A4	B5	0,7	L65
128	1.1 1100, S, SL, Sport, Sport Coupé			09.1969	12.1984	RC 62 LS	A6	B17	0,7	L65
	1.3 1300, S, SL, Rallye, Sport, Sport Coupé			03.1969	12.1984	RC 62 LS	A6	B17	0,7	L65
131	1.3 Mirafiori 1300, Super Mirafiori 1300			10.1974	01.1984	C 62 LS	A4	B5	0,7	L65
	1.4 Mirafiori 1300, 1400, Panorama 1300, 1400			11.1980	01.1984	C 62 LS	A4	B5	0,7	L65
	1.4 Super Mirafiori 1300, 1400			01.1981	01.1984	C 62 LS	A4	B5	0,7	L65
	1.6 Mirafiori 1600, Super Mirafiori 1600			03.1978	01.1984	C 62 LS	A4	B5	0,7	L65
	1.8 Mirafiori 1800			10.1974	12.1978	RC 62 LS	A6	B17	0,7	L65
	2.0 Abarth Rallye			01.1976	12.1979	C 82 LS	A40	B6	0,7	L87
	2.0 Brava, Mirafiori Sport, Racing, Super Brava			06.1978	12.1981	C 72 LS (1)	A30		0,7	L87
	2.0 Super Mirafiori 2000			06.1981	12.1984	C 82 LS	A40	B6	0,7	L87
	2.0 Super Mirafiori 2000	131.CC...	83/113	01.1981	12.1984	C 72 LS (1)	A30		0,7	L87
132	1.6 1600, GL, GLS			07.1979	05.1984	C 62 LS	A4	B5	0,7	L65
	1.8 1800 GLS			05.1972	02.1977	C 72 LS (1)	A30		0,7	L87
	2.0 2000 Berlina (Nuova Fiat)			07.1979	05.1984	C 62 LS	A4	B5	0,7	L65
	2.0 i 2000 ie			09.1979	05.1984	C 72 LS (1)	A30		0,7	L87
500	0.5				12.1975	C 42 S	A12	B7	0,6	N43
	0.6 ie Giardiniera				12.1975	C 62 S	A55		0,6	
500 II	NEW 0.9	312 A.4000	48/65	09.2012		RZC 82 HSDPS	A536		0,75	
	NEW 0.9	312 A.2000	63/86	07.2010		RZC 82 HSDPS	A536		0,75	
	1.2	169 A4.000	51/69	10.2007		RZC 62 LSE	A510		1,0	
	1.2 LPG	169 A4.000	51/69	12.2010		RZC 62 LSE	A510		1,0	
	1.4	169 A3.000	74/101	10.2007		RZC 62 LS 5	A509		1,0	
	NEW 1.4 Abarth	312 A.1000	99/135	08.2008		RZC 82 LSDPT	A535		0,85	
	NEW 1.4 Abarth	312 A.3000	132/180	08.2008		RZC 82 LSDPT	A535		0,85	
	NEW 1.4 Abarth Asseto Corse	312 A.1000	140/190	08.2008		RZC 82 LSDPT	A535		0,85	
500 C II	NEW 0.9	312 A.4000	48/65	09.2012		RZC 82 HSDPS	A536		0,75	
	NEW 0.9	312 A.2000	63/86	09.2009		RZC 82 HSDPS	A536		0,75	
	1.2	169 A4.000	51/69	09.2009		RZC 62 LSE	A510		1,0	
	1.4	169 A3.000	74/101	09.2009		RZC 62 LS 5	A509		1,0	
	NEW 1.4 Abarth	312 A.3000	103/140	09.2009		RZC 82 LSDPT	A535		0,85	
500 L	NEW 0.9	199 B.6000	77/105	09.2012		RZC 82 LSDPT	A535		0,85	
	NEW 0.9 Natural Power	312 A.2000	63/86	03.2013		RZC 82 LSDPT	A535		0,85	
900	0.9 E Furgone	100 GF 000	33/45	12.1979	12.1987	RC 62 LS	A6	B17	0,7	L65
	0.9 T	100 GF 000	26/35	10.1977	07.1981	C 62 LS	A4	B5	0,7	L65
ARGENTA	1.6 100, 1600	132.D - 132.FB	72/98	06.1981	11.1985	C 62 LS	A4	B5	0,7	L65
	2.0 110	132.D1	83/113	06.1983	11.1985	C 62 LS	A4	B5	0,7	L65
	2.0 ie 120 ie	132.C	90/122	06.1983	11.1985	C 62 LS	A4	B5	0,7	L65
	2.0 ie 2000, 2000 ie	132.FB - 132.GB	83-90/113-122	06.1981	05.1983	C 62 LS	A4	B5	0,7	L65
	2.0 SX, VX	132.E	100/136	03.1984	11.1985	C 72 LS (1)	A30		0,7	L87
BARCETTA	1.8 16V	183 A1.000	96/131	04.1995		RFC 58 LZK (a)	A11	B29	0,8	F54
	1.8 16V	188 A6.000	96/131	04.1995		RFC 42 LS	A25		0,7	F54
		Mot.Nr. 1945 439 -->								
	1.8 i, ie Lido, Riviera	183.A1.000	96/131	01.1995		RFC 58 LZ2	A54		1,0	F54

(1) Available until end of stock

(a) 30 000 km

(b) 60 000 km

(c) Grey sticker on ignition coil

(d) Green sticker on ignition coil

(e) Hex 21 mm

(f) Hex 16 mm

(g) Recommended for

cold weather



EYQUEM



Box
10

Blister
4



F3

FIAT											
BRAVA	1.2 16V 80	188 A5.000	59/80	10.2000	10.2001	RZC 58 LS	A190	B59	0,9		
	1.2 16V 80	182 B2.000	60/82	12.1998	10.2000	RZC 58 LS	A190	B59	0,9		
	1.4	182 A5.000	55/75	10.1995	10.1998	RFC 58 LZK (a)	A11	B29	0,8	F54	
	1.4 12V	182 A3.000	59/80	10.1995	10.1998	RFC 58 LZK (a)	A11	B29	0,8	F54	
	1.4 i 12V S, SX	182 A3-A5.000	55/75	08.1995	10.1998	RFC 58 LZ2	A54		1,0	F54	
	1.6 16V	182 A4.000	76/103	02.1996	10.1998	RFC 58 LZ2 (a)	A11	B29	0,8	F54	
	1.6 16V	182 A6.000	66/90	10.1995	10.1998	RFC 58 LZK (a)	A11	B29	0,8	F54	
	1.6 16V	182 A4.000	76/103	11.1998	10.2001	RFC 42 LS	A25		0,7	F54	
	1.6 i, ie	182 A4.027	77/105	11.1998		RFC 58 LZ2	A54		1,0	F54	
	1.6 i, ie EL, ELX, GT, HSX, SX	182 A4.000 Cat	76/103			RFC 58 LZ2	A54		1,0	F54	
	1.6 i, ie ELX, SX	182 A6.000	66/90	08.1995		RFC 58 LZ2	A54		1,0	F54	
	1.8 GT 16V	182 A2.000	83/113	08.1999	10.2001	RFC 42 LS	A25		0,7	F54	
		Mot.R. 1945 439 -->									
	1.8 GT 16V	182 A2.000	83/113	10.1995	07.1999	RFC 58 LZK (a)	A11	B29	0,8	F54	
		--> Mot.Nr. 1945 438									
	1.8 i, ie ELX, GT	182 A2.000	83/113	08.1995		RFC 58 LZ2	A54		1,0	F54	
BRAVO	1.2 16V 80	188 A5.000	59/80	10.2000	10.2001	RZC 58 LS	A190	B59	0,9		
	1.2 16V 80	182 B2.000	60/82	12.1998	10.2000	RZC 58 LS	A190	B59	0,9		
	1.4	182 A5.000	55/75	10.1995	10.1998	RFC 58 LZK (a)	A11	B29	0,8	F54	
	1.4	182 A3.000	59/80	10.1995	10.1998	RFC 58 LZK (a)	A11	B29	0,8	F54	
	1.4	182 A5.000	55/75	11.1998	10.2001	RFC 42 LS	A25		0,7	F54	
	1.4	182 A3.000	59/80	11.1998	10.2001	RFC 42 LS	A25		0,7	F54	
	1.6 16V	182 A4.000	76/103	03.1996	10.1998	RFC 58 LZK (a)	A11	B29	0,8	F54	
	1.6 16V	182 A6.000	66/90	10.1995	10.1998	RFC 58 LZK (a)	A11	B29	0,8	F54	
	1.6 16V	182 A4.000	76/103	11.1998	10.2001	RFC 42 LS	A25		0,7	F54	
	1.6 16V	182 A6.000	66/90	11.1998	10.2001	RFC 42 LS	A25		0,7	F54	
	1.6 i, ie	182 A4.027	77/105	11.1998		RFC 58 LZ2	A54		1,0	F54	
	1.6 i, ie EL, ELX, GT, HSX, SX	182 A4.000 Cat	76/103			RFC 58 LZ2	A54		1,0	F54	
	1.6 i, ie ELX, SX	182 A6.000	66/90	08.1995		RFC 58 LZ2	A54		1,0	F54	
	1.8 GT	182 A2.000	83/113	08.1999	10.2001	RFC 42 LS	A25		0,7	F54	
		Mot.R. 1945 439 -->									
1.8 GT	182 A2.000	83/113	10.1995	07.1999	RFC 58 LZK (a)	A11	B29	0,8	F54		
	--> Mot.Nr. 1945 438										
	1.8 i, ie ELX, GT	182 A2.000	83/113	08.1995		RFC 58 LZ2	A54		1,0	F54	
	2.0	6132 AZ 2000	59/80	06.1974	10.1986	RC 62 LS	A6	B17	0,7	L65	
	2.0 HGT 20V	182 B7.000	113/154	07.1998	10.2001	RFC 58 LZK (a)	A11	B29	0,8	F54	
	2.0 HGT 20V	182 A1.000	108/147	10.1995	07.1998	RFC 58 LZK (a)	A11	B29	0,8	F54	
	2.0 i 20V HGT	182 A1.000	108/147	08.1995	10.1998	RFC 58 LZ2	A54		1,0	F54	
BRAVO II	1.4	192 B2.000	66/90	04.2007		RZC 62 LS 5	A509		1,0		
		192 B2.000	66/90	11.2009		RZC 62 LS 5	A509		1,0		
	NEW 1.4 T-jet	198 A4.000	88/120	09.2007		RZC 82 LSDPT	A535		0,85		
	NEW 1.4 16V	198 A7.000	103/140	03.2008		RZC 82 LSDPT	A535		0,85		
NEW 1.4 T-jet	198 A1.000	110/150	09.2007		RZC 82 LSDPT	A535		0,85			
CINQUECENTO	0.7 700 Clim, S, ED	170.A.000 - 170.A.046	23/31	07.1991	05.1998	RC 62 LS	A6	B17	0,8	L65	
	0.9 i, ie	170.A1.046	30/41			RC 62 LS	A6	B17	0,8	L65	
	0.9 i, ie 900	1170.A1.046	29/39	07.1991	05.1998	RC 62 LS	A6	B17	0,8	L65	
	0.9 900	170.A1.000	29/39	10.1991	05.1998	RC 62 LS	A6	B17	0,8	L65	
	0.9 i, ie Young	1170.A1.046	29/39	07.1991	05.1998	RC 62 LS	A6	B17	0,8	L65	
	1.1 i, ie Sporting Fire	176.B2.000 - 176.A6.000	40/54	01.1994	05.1998	RFN 58 LZ (b)	A7	B28	0,9	F54	
	1.1 i, ie Sporting Fire	176.B2.000 - 176.A6.000	40/54	01.1994	05.1998	RFN 58 LZ3A (g)	A515		0,9		
	1.1 Sporting	176 B2.000	40/54	10.1994	01.1998	RFN 52 LZ	A27		0,7	F54	
CITIVAN	1.1			01.1989		RFC 52 LS	A3	B16	0,7	F54	
COUPE	1.8 16V	183 A1.000	96/131	03.1996		RFC 58 LZK (a)	A11	B29	0,8	F54	
	1.8 i, ie	183.A1.000	96/131	02.1996		RFC 58 LZ2	A54		1,0	F54	
	2.0 20V	182 A1.000	108/147	08.1996	04.1998	RFC 58 LZK (a)	A11	B29	0,8	F54	
	2.0 20V	182 B3.000	113/154	04.1998		RFC 58 LZK (a)	A11	B29	0,8	F54	
	2.0 i 20V	182.A1-B3.000	108-113/147-154	09.1996		RFC 58 LZ2	A54		1,0	F54	
	2.0 i, ie 16V	836.A3.000 - 836.A3.011	102-104/139-141	02.1994	12.1996	RC 72 LS	A32	B26	0,9	L87	
	2.0 ie 20V Turb	175.A3.000	162/220	09.1996		RFC 58 LZ3EX	A58	B55	0,9	F54	
	2.0 ie Turbo	175.A1.000	140-143/190-194	02.1994	12.1996	C 72 LS3X	A63		0,8	L87	
	CROMA	1.6	154.A.048	61/83	12.1985	06.1990	RC 72 LS	A32	B26	0,7	L87
	2.0 ie	154.A1.000	66/90	12.1985	02.1989	RC 72 LS	A32	B26	0,7	L87	
	2.0 ie	154.C2.000	72/98	12.1985	06.1990	RC 72 LS	A32	B26	0,7	L87	
	2.0 ie	834.B.048	83-89/113-121	12.1985	11.1992	RC 72 LS	A32	B26	0,7	L87	
	2.0 ie	834.AB.000	89/121	12.1985	11.1992	RC 72 LS	A32	B26	0,7	L87	

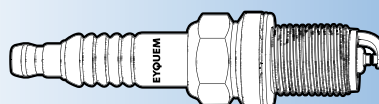

(1) Available until end of stock

- (a) 30 000 km
- (b) 60 000 km
- (c) Grey sticker on ignition coil
- (d) Green sticker on ignition coil

- (e) Hex 21 mm
- (f) Hex 16 mm
- (g) Recommended for cold weather



Box
10

Blister
4



F3-D1

FIAT

	2.0 ie	154.C5.000	66/90	07.1990	11.1992	RC 72 LS	A32	B26	0,7	L87
	2.0 ie	154.C3.046	85/115	07.1990	02.1997	RC 72 LS	A32	B26	0,7	L87
	2.0 ie	834.B.146	85/115	10.1990	02.1997	RC 72 LS	A32	B26	0,7	L87
	2.0 ie	154.C3.000	86/117	07.1990	02.1997	RC 72 LS	A32	B26	0,7	L87
	2.0 ie 16V	154.E1.000	101/137	01.1991	02.1997	RC 72 LS	A32	B26	0,7	L87
	2.0 ie Turbo	154.A2-C4.000 - 154.C4.046 - 834.C.146	110-117/150-159	12.1985	02.1997	C 72 LS3X	A63		0,8	L87
	2.0 ie Turbo	175.A1.000	143/194	02.1994	02.1997	C 72 LS3X	A63		0,8	L87
	2.5 ie V6	834.G.000	117/159	01.1993	02.1997	RC 72 LS	A32	B26	0,7	L87
CROMA II	NEW 1.8 16v	939.A4.000	103/140	12.2005		RFN 42 LZG	A532		0,9	
	2.2 i 16v		108/147	06.2005		RC 42 HJS3E5	A179		1,1	
DAILY	2.0			01.1980		RC 72 LS	A32	B26	0,7	L87
DOBLO I	1.2	223.A5.000	48/65	03.2001		RFC 42 LS	A25		0,7	F54
	1.4	350.A1.000	57/78	10.2005		RZC 62 LSE	A510		1,0	
DOBLO II	1.4	843.A1.000	70/95	02.2010		RZC 62 LS 5	A509		1,0	
	1.4	198.A4.000	88/120	10.2011		RZC 62 LS 5	A509		1,0	
DOBLO II	NEW 1.4 Natural Power	198.A4.000	88/120	06.2010		RZC 82 LSDPT	A535		0,85	
Camionette										
DOBLO II	NEW 1.4 Natural Power	198.A4.000	88/120	02.2010		RZC 82 LSDPT	A535		0,85	
Monospace										
DUCATO	10 : 1.8	XM7 T		09.1981	12.1990	C 62 LS	A4	B5	0,6	L65
	10 : 2.0	XN1T [170..]		09.1981	12.1990	C 62 LS	A4	B5	0,6	L65
	2.0	RFW	80/109	03.1994	04.2002	RFC 52 LS	A3	B16	0,7	F54
	2.0	RFL	81/110	04.2002		RFN 52 LZ	A27		0,7	F54
	2.0 10, 13, 14, 18 Maxi	XN1T		09.1981	02.1994	C 62 LS	A4	B5	0,6	L65
	2.0 Bipower		81/110	11.2002		RFC 52 LS	A3	B16	0,7	F54
	2.0 i 10, 14, 18	XU10 J2U [RFW]	80/109	03.1994		RFC 58 LZK (a)	A11	B29	0,9	F54
	2.0 i 10, 14, 18	XU10 J2U [RFW]	80/109	03.1994		RFN 58 LZ (b)	A7	B28	0,9	F54
	2.0 i 10, 14, 18	XU10 J2U [RFW]	80/109	03.1994		RFN 58 LZ3A (g)	A515		0,9	
	2.0 Panorama/Combinato	RFW	80/109	03.1994	04.2002	RFC 52 LS	A3	B16	0,7	F54
DUNA	1.1 60, 60 Weekend	146.A6.000	43/58	10.1986	12.1990	RC 62 LS	A6	B17	0,8	L65
	1.3 70, 70 Weekend	146.A5.000	48/65	10.1986	12.1990	RC 62 LS	A6	B17	0,8	L65
FIORINO	0.9 900	903...	33/45	10.1977	03.1981	RC 62 LS	A6	B17	0,7	L65
	1.0 1050	127.A - M201		01.1980	12.1987	RC 62 LS	A6	B17	0,7	L65
	1.1 1100	146.A9.000	40/54	12.1987	08.1993	RC 62 LS	A6	B17	0,7	L65
	1.3 1300	146.A5.000	49/67	12.1987	10.1994	RC 62 LS	A6	B17	0,7	L65
	1.4	146.D5.000	49/67	05.1994	05.2001	RFC 52 LS	A3	B16	0,7	F54
	1.4 ie	160.A1.046	51/69	01.1993		RC 52 LS	A9	B20	0,9	L65
	1.4 ie 1400 ie	146.C5 - 146.D5	52/71	09.1993		RC 62 LS	A6	B17	0,7	L65
	1.5 ie 1500 ie	149.C1.000 Cat	55/75	01.1988	12.1989	RC 62 LS	A6	B17	0,7	L65
	1.5 ie 1500 ie	149.C1.000 Cat	55/75	01.1990	08.1993	RC 72 LS	A32	B26	0,7	L87
	1.6 ie 1600 ie	146.C6.000	55/75	09.1993		RC 72 LS	A32	B26	0,7	L87
	1.6 ie 1600 ie	146.D6.000	59/80	06.1995		RFN 62 LZ	A71		0,9	F86
FIORINO IV	1.4	KFT / KFV	54/73	02.2008		RFN 58 LZ (b)	A7	B28	0,9	F54
	1.4	KFT / KFV	54/73	02.2008		RFN 58 LZ3A (g)	A515		0,9	
IDEA	1.2 16V	188.A5.000	59/80	01.2004		RZC 58 LS	A190	B59	0,9	
	1.2 16V	188.A5.000	59/80	01.2004		RZC 62 LS 5	A509		1,0	
	1.4	350.A1.000	57/78	10.2005		RZC 62 LSE	A510		1,0	
	1.4	192.B2.000	66/90	12.2003		RZC 62 LS 5	A509		1,0	
	1.4 16V	843.A1.000	70/95	01.2004		RZC 58 LS	A190	B59	0,9	
	1.4 16V	843.A1.000	70/95	01.2004		RZC 62 LS 5	A509		1,0	
	1.4	350.A1.000	57/78	06.2007		RZC 62 LSE	A510		1,0	
LINEA	1.4 T-jet	198.A4.000	88/120	09.2007		RZC 82 LSDPT	A535		0,85	
LINEA (323)	NEW 1.4 i S, SX	182.A3.000	59/80	09.1996	02.1999	RFC 58 LZ2	A54		1,0	F54
	1.6 i 16V ELX, SX	186.A4.000	76/103	09.1996		RFC 58 LZ2	A54		1,0	F54
	1.6 i, ie ELX, SX	182.A4.000 Cat	76/103	09.1996		RFC 58 LZ2	A54		1,0	F54
	1.8 i, ie ELX, HLX	182.A2.000	83/113	09.1996		RFC 58 LZ2	A54		1,0	F54
	2.0 i 20V ELX, HLX	182.A1.000	108/147	09.1996	02.1999	RFC 58 LZ2	A54		1,0	F54
MAREA, Weekend	1.2 16V	182.B2.000	60/82	10.1998		RZC 58 LS	A190	B59	0,9	
	1.4 80 12V Weekend	182.A3.000	59/80	09.1996	03.1999	RFC 58 LZK (a)	A11	B29	0,8	F54
	1.6 100 16V Bipower Weekend	185.A3.000/186.A4.000	76/103	04.1999		RFC 42 LS	A25		0,7	F54
	1.6 100 16V Weekend	182.A4.000	76/103	04.1999		RFC 42 LS	A25		0,7	F54
	1.6 100 16V Weekend	182.A4.000	76/103	09.1996	03.1999	RFC 58 LZK (a)	A11	B29	0,8	F54
	1.8 115 16V Weekend	182.A2.000	83/113	08.1999		RFC 42 LS	A25		0,7	F54

Mot.Nr. 1945 439 -->

(1) Available until end of stock

(a) 30 000 km

(b) 60 000 km

(c) Grey sticker on ignition coil

(d) Green sticker on ignition coil

(e) Hex 21 mm

(f) Hex 16 mm

(g) Recommended for cold weather



EYQUEM



Box
10

Blister
4



F3 → 1

FIAT										
	1.8 115 16V Weekend	182 A2.000	83/113	09.1996	07.1999	RFC 58 LZK (a)	A11	B29	0,8	F54
		--> Mot.Nr. 1945 438								
	2.0 150 20V Weekend	185 A8.000	110/150	01.2001		RFC 58 LZK (a)	A11	B29	0,8	F54
	2.0 150 20V Weekend	182 A1.000	108/147	09.1996	04.1999	RFC 58 LZK (a)	A11	B29	0,8	F54
	2.0 155 20V Weekend		113/154	04.1999	01.2001	RFC 58 LZK (a)	A11	B29	0,8	F54
MULTIPLA	1.6 100 16V	182 A4.000	76/103	04.1999		RFC 42 LS	A25		0,7	F54
	1.6 16V Bipower	186 A4.000	76/103	04.1999		RFC 42 LS	A25		0,7	F54
	1.6 16V Blupower	186 A3.000	70/95	04.1999		RFC 42 LS	A25		0,7	F54
	1.6 i 16V 100 ELX	178.B3.000 [DOHC]	76/103	01.1999		RFC 58 LZ2	A54		1,0	F54
	1.6 i 16V 100, SX	186.A3-A4.000 - 178.B3.000	68-76/94-103	01.1999		RFC 58 LZ2	A54		1,0	F54
	1.6 i, ie 100, SX	182.A4.000 Cat	76/103	01.1999		RFC 58 LZ2	A54		1,0	F54
PALIO	1.0		56/76	04.1996		RFC 62 LS	A48		0,7	F86
	1.2	178E2.000	54/73	06.1998		RFC 58 LZK (a)	A11	B29	0,8	F54
	1.2	188 A5.000	59/80	09.2001		RZC 72 LS	A508		0,9	
	1.2 i 65	178.E2.000	50/68	01.2000		RFC 58 LZ2	A54		1,0	F54
	1.2 i 75	178.B5.000	54/73	04.1996		RFN 58 LZ (b)	A7	B28	0,9	F54
	1.2 i 75	178.B5.000	54/73	04.1996		RFN 58 LZ3A (g)	A515		0,9	
	1.4	178 B2.000	51/69	04.1996		RFC 62 LS	A48		0,7	F86
	1.4 i	178.B2.000	51/69	09.1997		RFN 58 LZ (b)	A7	B28	0,9	F54
	1.4 i	178.B2.000	51/69	09.1997		RFN 58 LZ3A (g)	A515		0,9	
	1.4 KAT	178B2.016	51/69	04.1996		RFC 62 LS	A48		0,7	F86
	1.5		57/78	04.1996	06.1998	RFC 62 LS	A48		0,7	F86
	1.5 i	178.A5.011	56/76	04.1996		RFN 58 LZ (b)	A7	B28	0,9	F54
	1.5 i	178.A5.011	56/76	04.1996		RFN 58 LZ3A (g)	A515		0,9	
	1.6 16V	178 B3.000	74/101	04.1996		RFC 42 LS	A25		0,7	F54
	1.6 i	SPI 8V		04.1996		RFC 52 LS	A3	B16	0,8	F54
	1.6 i 16V 100	178.B3.000 [DOHC]	74-76/100-103			RFC 58 LZ2	A54		1,0	F54
PALIO Weekend	1.2, Weekend	188 A5.000	59/80	09.2001		RZC 72 LS	A508		0,9	
	1.2, Weekend	178 B5.000	54/73	04.1996	02.2001	RFC 58 LZK (a)	A11	B29	0,8	F54
	1.2, Weekend	188 A4.000	44/60	02.2001	09.2001	RFC 42 LS	A25		0,7	F54
	1.6 16V, Weekend	182 B6.000	76/103	02.2001		RFC 42 LS	A25		0,7	F54
	1.6 16V, Weekend	178 B3.000	74/101	04.1996	02.2001	RFC 42 LS	A25		0,7	F54
PANDA	0.65 30	141 AE...	22/30	03.1980	12.1985	RC 62 S	A95		0,7	
	0.8 34, Young	M 020 BS	25/34	02.1981	12.1985	RC 62 LS	A6	B17	0,7	L65
	0.8 35				06.1983	RC 62 LS	A6	B17	0,7	L65
	750	156 A4.000	25/34	01.1986	01.1995	RFC 62 LS	A48		0,7	F86
	750 : 0.8	156.A4.048 - 156.A4.000	24-25/33-34	01.1986	12.1992	RFC 52 LS	A3	B16	0,8	F54
	750 : 0.8 Fire	141.B.000	25/34	01.1986	07.1992	RC 62 LS	A6	B17	0,7	L65
	750 KAT	156 A4.048	25/34	01.1995	12.1997	RFC 62 LS	A48		0,7	F86
	0.9 45, S, 903	146.A.000	33/45	02.1981	03.1992	RC 62 LS	A6	B17	0,7	L65
	0.9, Trans, 40, 45				12.1986	RC 62 LS	A6	B17	0,7	L65
	0.9 ie L, CLX	1170.A1.046	29/39	04.1992	08.1995	RC 62 LS	A6	B17	0,7	L65
	900	1170 A1.046	29/39	11.1995	12.1996	RFC 42 LS	A25		0,7	F54
	1.0 1000 Fire Europa, CL, CLX, Estival, Malicia, S, Super	156.A2.000	33/45	01.1986	12.1991	RFC 52 LS	A3	B16	0,8	F54
	1.0 48 4x4	A.112.B1.054	36/49	04.1983	12.1985	RC 62 LS	A6	B17	0,7	L65
	1.0 ie 1000, 4x4, Bluebay, Brio, Mod, Pop, Selecta	156.A2.146 - 156.A2.246	33/45	10.1987	05.1991	RFN 58 LZ (b)	A7	B28	0,8	F54
	1.0 ie 1000, 4x4, Bluebay, Brio, Mod, Pop, Selecta	156.A2.146 - 156.A2.246	33/45	10.1987	05.1991	RFN 58 LZ3A (g)	A515		0,8	
	1.0 ie 1000, ie, ie 4x4, Selecta	156.A2.048	33/45	01.1986	04.1992	RFC 52 LS	A3	B16	0,8	F54
	1.0 ie 4x4 Fire, CLX, Pop, Val d'Isère, Piste Noire	156.A2.100 - 156.A3.000	32-37/44-50	01.1986	12.1995	RFC 52 LS	A3	B16	0,8	F54
	1000		32/44	08.1990	04.1992	RFC 62 LS	A48		0,7	F86
	1000 4x4	156 A2.100/156 A3.100	32/44	01.1986	07.1989	RFC 62 LS	A48		0,7	F86
	1000 4x4	156 A3.000	37/50	01.1986	12.1992	RFC 62 LS	A48		0,7	F86
	1000 4x4	141 C2.000/156 A2.246	33/45	05.1986	12.1994	RFN 52 LZ	A27		0,9	F54
	1000 i.e. KAT	141 C2.000/156 A2.246	33/45	10.1987	08.1998	RFN 52 LZ	A27		0,9	F54
	1.1 i, ie 1100 ie, Selecta, 4x4 Val d'Isère, Trekking, Country Club	176.B2.000	40/54	01.1995		RFN 58 LZ (b)	A7	B28	0,8	F54
	1.1 i, ie 1100 ie, Selecta, 4x4 Val d'Isère, Trekking, Country Club	176.B2.000	40/54	01.1995		RFN 58 LZ3A (g)	A515		0,8	
	1.1 ie 1100 ie, Selecta, 4x4 Val d'Isère, Trekking, Country Club	156.C.046 Cat	37/50	07.1990	07.1995	RFN 58 LZ (b)	A7	B28	0,8	F54



(1) Available until end of stock

- (a) 30 000 km
- (b) 60 000 km
- (c) Grey sticker on ignition coil
- (d) Green sticker on ignition coil

- (e) Hex 21 mm
- (f) Hex 16 mm
- (g) Recommended for cold weather



kW/HP



Box
10

Blister
4



F3-D1

FIAT

	1.1 ie 1100 ie, Selecta, 4x4 Val d'Isère, Trekking, Country Club	156.C.046 Cat	37/50	07.1990	07.1995	RFN 58 LZ3A (g)	A515		0,8	
	1.1 ie 1100 ie, Selecta, Trekking 4x4	156.C.000	41/56	10.1991	03.1992	RFC 52 LS	A3	B16	0,8	F54
	1100	176 B2.000/187 A1.000	40/54	02.1995	09.2003	RFN 52 LZ	A27		0,9	F54
	1100	156 C.046	37/50	05.1991	12.1999	RFN 52 LZ	A27		0,9	F54
	1100 4x4	176 B2.000	40/54	02.1995		RFN 52 LZ	A27		0,9	F54
	1100 Trekking 4x4	156 C.046	37/50	10.1991		RFN 52 LZ	A27		0,9	F54
PANDA II	1.1	187 A1.000	40/54	09.2003		RFC 42 LS	A25		0,8	F54
		--> Mot.Nr. 2533528								
	1.1	187 A1.000	40/54	09.2003		RZC 58 LS	A190	B59	0,9	
		Mot.Nr 2533529 -->								
	1.1 i	187 A1.000	40/54	09.2003		RFN 52 LZ	A27		0,9	F54
	1.2	188 A4.000	44/60	09.2003		RFC 42 LS	A25		0,8	F54
		--> Mot.Nr. 2533528								
	1.2	188 A4.000	44/60	09.2003		RZC 58 LS	A190	B59	0,9	
		Mot.Nr 2533529 -->								
	1.2	188 A4.000	44/60	09.2003		RZC 62 LS 5	A509		1,0	
	1.2	169 A4.000	51/69	03.2010		RZC 62 LSE	A510		1,0	
	1.2 4x4	188 A4.000	44/60	10.2004		RZC 62 LS 5	A509		1,0	
	1.2 4x4	188 A4.000	44/60	10.2004		RFC 42 LS	A25		0,8	F54
		--> Mot.Nr. 2533528								
	1.2 4x4	188 A4.000	44/60	10.2004		RZC 58 LS	A190	B59	0,9	
		Mot.Nr 2533529 -->								
	1.2 Bi-Power / Natural Power	188 A4.000	44/60	01.2007		RZC 62 LS 5	A509		1,0	
	1.2 i	188 A4.000	44/60	09.2003		RFN 52 LZ	A27		0,9	F54
	1.2 LPG	188 A4.000	44/60	04.2009		RZC 62 LS 5	A509		1,0	
	1.4	169 A3.000	74/101	10.2006		RZC 62 LS 5	A509		1,0	
PANDA III	0.9	312 A4.000	48/65	02.2012		RZC 58 LS	A190	B59	0,9	
	NEW 0.9	312 A2.000	57/78	02.2012		RZC 82 HSDPS	A536		0,75	
	NEW 0.9	312 A2.000	63/86	02.2012		RZC 82 HSDPS	A536		0,75	
	NEW 0.9 4x4	312 A2.000	63/86	09.2012		RZC 82 HSDPS	A536		0,75	
	NEW 0.9 Natural Power	312 A2.000	63/86	07.2012		RZC 82 HSDPS	A536		0,75	
	1.2	169 A4.000	51/69	02.2012		RZC 62 LSE	A510		1,0	
PENNY	1.1		41/56	01.1988		RC 62 LS	A6	B17	0,7	L65
	1.3		48/65	01.1988		RC 62 LS	A6	B17	0,7	L65
PUNTO	1.1 i 55 S, SX, "6 Speed"	176 A6.000	40/54	08.1993	05.1997	RFN 58 LZ (b)	A7	B28	0,9	F54
	1.1 i 55 S, SX, "6 Speed"	176 A6.000	40/54	08.1993	05.1997	RFN 58 LZ3A (g)	A515		0,9	
	1.1 Van	176 B2.000	40/54	04.1996	02.2000	RFN 52 LZ	A27		0,9	F54
	55 1.1	176 A6.000/176 B2.000	40/54	09.1993	09.1999	RFN 52 LZ	A27		0,9	F54
	1.2 i 60 S, SX, Cabrio, Cult	176 A7.000	44/60	08.1993	08.1999	RFN 58 LZ (b)	A7	B28	0,9	F54
	1.2 i 60 S, SX, Cabrio, Cult	176 A7.000	44/60	08.1993	08.1999	RFN 58 LZ3A (g)	A515		0,9	
	60 1.2	176 A7.000	43/58	01.1994	09.1999	RFN 52 LZ	A27		0,9	F54
	60 1.2	176 B1.000/176 B4.000	44/60	03.1994	09.1999	RFN 52 LZ	A27		0,9	F54
	60 1.2 Cabriolet	176 A7.000	43/58	04.1994	06.2000	RFN 52 LZ	A27		0,9	F54
	60 1.2 Cabriolet	176 B1.000/176 B4.000	44/60	05.1995	06.2000	RFN 52 LZ	A27		0,9	F54
	1.2 i 75 SX, ELX, HSD	176 A8.000	54/73	08.1993	08.1999	RFN 58 LZ (b)	A7	B28	0,9	F54
	1.2 i 75 SX, ELX, HSD	176 A8.000	54/73	08.1993	08.1999	RFN 58 LZ3A (g)	A515		0,9	
	75 1.2	176 A8.000	54/73	01.1994	09.1999	RFN 52 LZ	A27		0,9	F54
	1.2, 85 16V	176 B9.000	63/86	04.1997	09.1999	RZC 58 LS	A190	B59	0,9	
	1.2 85 16V Cabriolet	176 B9.000	63/86	04.1997	06.2000	RZC 58 LS	A190	B59	0,9	
	1.2 i Cabrio, Selecta, SX	176 B4.000	43/58	06.1995	08.1999	RFN 58 LZ (b)	A7	B28	0,9	F54
	1.2 i Cabrio, Selecta, SX	176 B4.000	43/58	06.1995	08.1999	RFN 58 LZ3A (g)	A515		0,9	
	1.2 i ELX, SX	188 A4.000	44/60	09.1999		RFN 52 LZ	A27		0,9	F54
	1.2 i Selecta	176 B1.000	43/58	06.1994	05.1997	RFN 58 LZ (b)	A7	B28	0,9	F54
	1.2 i Selecta	176 B1.000	43/58	06.1994	05.1997	RFN 58 LZ3A (g)	A515		0,9	
	1.4 i Turbo GT Turbo	176 B6.000	96/131	06.1997	08.1999	RFC 62 LS3X	A59		0,9	F86
	1.4 i Turbo GT Turbo	176 A4.000	98/133	08.1993	05.1997	RFC 62 LS3X	A59		0,9	F86
	1.6 i 90, Cabrio, ELX, Sporting, SX	176 A9.000	65/88	01.1994	05.1998	RFN 62 LZ	A71		0,9	F86
PUNTO II	1.2 16V 80	188 A5.000	59/80	09.1999		RZC 58 LS	A190	B59	0,9	
	1.2 16V 80 (188.233, .235, .253, .255, .333, .353, .639, .63	188 A5.000	59/80	09.1999		RZC 72 LS	A508		0,9	
	1.2 60	188 A4.000	44/60	09.1999		RFC 42 LS	A25		0,8	F54
	1.2 60, Van	188 A4.000	44/60	02.2000		RFC 42 LS	A25		0,8	F54
	1.4		70/95	09.2003		RZC 58 LS	A190	B59	0,9	
	1.4	843 A1.000	70/95	09.2003		RZC 62 LS 5	A509		1,0	

(1) Available until end of stock

(a) 30 000 km

(b) 60 000 km

(c) Grey sticker on ignition coil

(d) Green sticker on ignition coil

(e) Hex 21 mm

(f) Hex 16 mm

(g) Recommended for cold weather

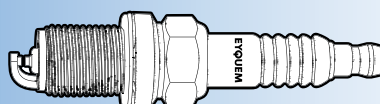

EYQUEM



Box
10

Blister
4



F3

FIAT									
	1.8 130 HGT	183 A1.000/188 A6.000	96/131	09.1999		RFC 42 LS	A25	0,8	F54
	1.8 i, ie HGT	183.A1.000	96/131	09.1999		RFC 58 LZ2	A54	1,0	F54
PUNTO III	NEW 0.9 Bifuel	312 A2.000	63/86	03.2012		RZC 82 HSDPS	A536	0,75	
	NEW 0.9 Twinair turbo	312 A2.000	63/86	03.2012		RZC 82 HSDPS	A536	0,75	
	NEW 1.4	199 A.7000	55/75	03.2012		RZC 82 LSDPT	A535	0,85	
	NEW 1.4 Multi Air	955 A6.000	77/105	03.2012		RZC 82 LSDPT	A535	0,85	
	NEW 1.4 T-jet	198 A4.000	88/120	09.2007		RZC 82 LSDPT	A535	0,85	
	NEW 1.4 Abarth	199 A8.000	114/155	12.2007		RZC 82 LSDPT	A535	0,85	
	NEW 1.4 Abarth	199 A8.000/ 955 A.8000	132/180	12.2007		RZC 82 LSDPT	A535	0,85	
	1.2	169 A4.000	51/69	02.2012		RZC 62 LSE	A510	1,0	
	1.4	199 A7.000	55/75	03.2012		RZC 58 LS	A190	B59	0,9
PUNTO / GRANDE PUNTO (199)	1.2	199 A4.000	48/65	10.2005		RZC 62 LSE	A510	1,0	
	1.4	350 A1.000	57/78	10.2005		RZC 62 LSE	A510	1,0	
	1.4 16V	199 A6.000	70/95	10.2005		RZC 62 LSE	A510	1,0	
	NEW 1.4 T-jet	198 A4.000	88/120	09.2007		RZC 82 LSDPT	A535	0,85	
	NEW 1.4 Abarth	199 A8.000	114/155	12.2007		RZC 82 LSDPT	A535	0,85	
	NEW 1.4 Abarth	199 A8.000/ 955 A.8000	132/180	12.2007		RZC 82 LSDPT	A535	0,85	
PUNTO EVO	1.2	199 A4.000	48/65	10.2009		RZC 62 LSE	A510	1,0	
	1.2	169 A4.000	51/69	02.2012		RZC 62 LSE	A510	1,0	
	1.4	199 A7.000	55/75	03.2012		RZC 58 LS	A190	B59	0,9
	1.4	350 A1.000	57/78	10.2009		RZC 62 LSE	A510	1,0	
	1.4 16V	955 A6.000	77/105	10.2009	02.2012	RZC 58 LS	A190	B59	0,9
	NEW 1.4 16V	955 A2.000	99/135	10.2009	02.2012	RZC 82 LSDPT	A535	0,85	
	NEW 1.4 Abarth	955 A8.000	120/163	10.2009		RZC 82 LSDPT	A535	0,85	
QUBO	1.4	KFT / KJV	54/73	09.2008		RFN 58 LZ (b)	A7	B28	0,9 F54
	1.4 Natural Power	350 A.1000	57/78	10.2009		RZC 58 LS	A190	B59	0,9
REGATA	1.1 60	146.A4	43/58	05.1985	07.1989	RC 62 LS	A6	B17	0,7 L65
	1.3 70, S, ES, Strada, Weekend	138.B2 - 149.A7 - 149.A3 - 149.C4		09.1983	09.1990	RC 62 LS	A6	B17	0,7 L65
	1.5 75	138.B3.048	55/75	09.1983	03.1985	RC 72 LS	A32	B26	0,7 L87
	1.5 75, S, Weekend	138.C3...	55/75	04.1985	07.1989	RC 62 LS	A6	B17	0,7 L65
	1.5 85, 85 S	138.B3 - 149.A5		09.1983	12.1987	RC 72 LS	A32	B26	0,7 L87
	1.5 ie 75 ie	149.C1.000 Cat	55/75	05.1987	06.1990	RC 72 LS	A32	B26	0,7 L87
	1.5 ie 75 ie, Weekend	138.C2... Cat	55/75	10.1985	04.1987	RC 62 LS	A6	B17	0,7 L65
	1.6 100S	149.A4.000	74/101	12.1984	05.1986	RC 72 LS	A32	B26	0,7 L87
	1.6 85, 85S	149.A.000	62/84	01.1984	09.1990	RC 62 LS	A6	B17	0,7 L65
	1.6 ie 90 ie, Europa, Weekend, 100 S ie Weekend	149.C2 - 149.C3		06.1986	09.1990	RC 62 LS	A6	B17	0,7 L65
	100S : 1.6 100S	149.A2...	74/101	09.1983	11.1984	RC 62 LS	A6	B17	0,7 L65
	100S : 1.6 100S	149.A2...	74/101	12.1984	06.1990	RC 72 LS	A32	B26	0,7 L87
RITMO	1.1 60, 60 ES			07.1978	12.1987	RC 62 LS	A6	B17	0,7 L65
	65 : 1.2 L, CL, N				05.1986	RC 62 LS	A6	B17	0,7 L65
	1.3 65, 70	138.B2 - 149.A7		01.1978	06.1988	RC 62 LS	A6	B17	0,7 L65
	75 : 1.4 CLX, CL, LN				05.1986	RC 62 LS	A6	B17	0,7 L65
	1.5 75	138.C3.048		01.1978	12.1987	RC 62 LS	A6	B17	0,7 L65
	1.5 Super 75, Super 85, Cabriolet	138.AE - 138.B3 - 149.A5		01.1981	12.1987	RC 72 LS	A32	B26	0,7 L87
	1.6 100 CLX, Crono	149.A4.000	74-77/100-105	05.1985	12.1987	RC 72 LS	A32	B26	0,7 L87
	1.6 ie 90 ie, 100 ie, 105 TC	149.C2 - 149.C3		05.1981	09.1988	RC 62 LS	A6	B17	0,7 L65
	1.7 D	138.C...	44/60	05.1985	12.1987	RC 72 LS	A32	B26	0,7 L87
	2.0 105 TC, Abarth	138.AR...	77/105	09.1980	07.1981	RC 62 LS	A6	B17	0,7 L65
	2.0 125 TC Abarth	138.AR.1...	92/125	11.1981	09.1988	RC 72 LS	A32	B26	0,7 L87
	2.0 130 TC Abarth	138.AR.2...	96/131	11.1981	09.1988	RC 72 LS	A32	B26	0,7 L87
SCUDO	1.6 i	220.A2.000	59/80	10.1995		RFN 62 LZ	A71		0,8 F86
	1.8 i	XU7 JP [L6B]	68/92			RFN 58 LZ (b)	A7	B28	0,9 F54
	1.8 i	XU7 JP [L6B]	68/92			RFN 58 LZ3A (g)	A515		0,9
	2.0	RFN	100/136	09.2002		RFN 52 HZ	A157	B50	0,9
	2.0 16V	RFN	100/136	06.2000		RFN 52 HZ	A157	B50	0,9
SEICENTO	0.9 i, ie	1170.A1.046	29/39			RC 62 LS	A6	B17	0,7 L65
	0.9 i, ie Citymatic, Clim, Hobby, S, SX, Young	170.A1.046	30/41	03.1998		RC 62 LS	A6	B17	0,7 L65
	1.1	176 B2.000/187 A1.000	40/54	01.1998		RFN 52 LZ	A27		0,9 F54
	1.1 i, ie Sporting, Sporting Abarth	176.B2.000	40/54	04.1998		RFN 58 LZ (b)	A7	B28	0,9 F54
	1.1 i, ie Sporting, Sporting Abarth	176.B2.000	40/54	04.1998		RFN 58 LZ3A (g)	A515		0,9
SERIE 240	1.4 237, 238, 241, 242				12.1982	RC 62 LS	A6	B17	0,7 L65

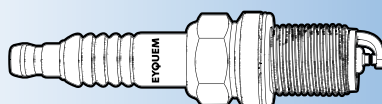

- (1) Available until end of stock
- (a) 30 000 km
- (b) 60 000 km
- (c) Grey sticker on ignition coil
- (d) Green sticker on ignition coil

- (e) Hex 21 mm
- (f) Hex 16 mm
- (g) Recommended for cold weather



KW/HP



Box
10

Blister
4



F3-D1

FIAT

SIENA	1.2	178 B5.000	54/73	09.1998		RFC 42 LS	A25		0,8	F54
	1.4	178 B2.000	51/69	04.1996		RFC 52 LS	A3	B16	0,8	F54
	1.6 16V		78/106	09.1998		RFC 42 LS	A25		0,8	F54
SPIDER	2.0 Europa Volumex				12.1985	C 82 LS	A40	B6	0,7	L87
	2.0 i Europa				12.1985	RC 62 LS	A6	B17	0,7	L65
STILO	1.2 16V	188 A5.000	59/80	02.2002		RZC 58 LS	A190	B59	0,9	
	1.4 16V	843 A1.000	70/95	01.2004		RZC 58 LS	A190	B59	0,9	
	1.4 16V	843 A1.000	70/95	01.2004		RZC 62 LS 5	A509		1,0	
	1.4 16V	843 A1.000	66/90	03.2005		RZC 58 LS	A190	B59	0,9	
	1.4 16V	192 B2.000	66/90	03.2005		RZC 62 LS 5	A509		1,0	
	1.6 16v	182 B6.000	76/103	10.2001		RFN 52 LZ	A27		0,9	F54
	1.6 16V	182 B6.000	76/103	10.2001		RFC 42 LS	A25		0,8	F54
NEW	1.6 16V	192 B3.000	77/105	05.2005	11.2006	RFN 42 LZG	A532		0,9	
	1.8 16v	192 A4.000	98/133	10.2001		RFN 58 LZ (b)	A7	B28	0,9	F54
	1.8 16V	192 A4.000	98/133	10.2001		RFC 42 LS	A25		0,8	F54
	1.8 16v	192 A4.000	98/133	10.2001		RFN 58 LZ3A (g)	A515		0,9	
	2.4 20v	192 A2.000	125/170	10.2001		RFN 58 LZ (b)	A7	B28	0,9	F54
	2.4 20V	192 A2.000	125/170	10.2001		RFC 58 LZK (a)	A11	B29	0,8	F54
	2.4 20v	192 A2.000	125/170	10.2001		RFN 58 LZ3A (g)	A515		0,9	
STILO Multi Wagon	1.4 16V	843 A1.000	70/95	01.2004		RZC 62 LS 5	A509		1,0	
	1.4 16V	192 B2.000	66/90	03.2005		RZC 62 LS 5	A509		1,0	
NEW	1.6 16V	192 B3.000	77/105	05.2005	12.2007	RFN 42 LZG	A532		0,9	
STRADA	1.2	188 A4.000	44/60	04.2003		RZC 62 LS 5	A509		1,0	
TALENTO	2.0	XN1T [170..]	55/75	07.1990		RC 62 LS	A6	B17	0,6	L65
TEMPRA	1.4 i.e.	160 A1.046/836 A4.000	51/69	03.1995	08.1996	RFN 52 LZ	A27		0,9	F54
	1.4 ie S, SW	836.A4.000	51/69	10.1994	12.1996	RC 72 LS	A32	B26	0,7	L87
	1.4 ie S, SX	159.A2.000	56/76	02.1990	04.1993	RC 62 LS	A6	B17	0,9	L65
	1.4 ie S, SX	160.A1.046	51/69	03.1992	12.1996	RC 62 LS	A6	B17	0,9	L65
	1.4 ie Station Wagon	159.A2.000	56/76	02.1990	04.1993	RC 62 LS	A6	B17	0,9	L65
	1.4 ie SW, Pop	160.A1.046	51/69	03.1992	12.1996	RC 62 LS	A6	B17	0,9	L65
	1.6 ie HSD, Liberty, S, SX, SW, Perfect	835.C1.000	55/75	01.1993	12.1996	RFN 62 LZ	A71		0,9	F86
	1.6 ie S, SW, SX, Perfect, Selecta	159.A3.000	63/86	02.1990	04.1993	RC 72 LS	A32	B26	0,7	L87
	1.6 ie SX Selecta, SRX Selecta	159.A3.046	52-57-59/71-78-80	06.1990	07.1992	RC 72 LS	A32	B26	0,7	L87
	1.6 ie SX Selecta, SRX Selecta	159.A3.048	55/75	06.1992	12.1996	RFC 62 LS	A48		0,7	F86
	1.8 ie 16V SLX, ie SX, ie Station Wagon	835.C2.000 Cat	76/103	04.1993	12.1996	RC 72 LS	A32	B26	0,7	L87
	1.8 ie SLX, ie SX, ie Station Wagon	159.A5.046 - 159.A4.000	77-81/105-110	02.1990	04.1993	RC 72 LS	A32	B26	0,7	L87
	1.8 ie SLX, ie SX, ie Station Wagon	835.C4.000 - 159.A4.046	66-77/90-105	04.1993	12.1996	RC 72 LS	A32	B26	0,7	L87
	2.0 ie SLX, Selecta, SX	159.A6.046	83-85/113-115	02.1990	12.1996	RC 72 LS	A32	B26	0,7	L87
TIPO	1.1 Fire	160.A3.000	41/56	07.1987	03.1993	RFC 52 LS	A3	B16	0,8	F54
	1.4 ie Estival, Pop, Selecta, S, Sienna, SX	160.A1.046 - 160.A1.000	51-52/69-71	07.1987	10.1995	RC 62 LS	A6	B17	0,9	L65
	1.4 ie Estival, Pop, Selecta, S, Sienna, SX	160.A1.048	52/71	07.1987	11.1990	RC 62 LS	A6	B17	0,9	L65
	1.4 ie Estival, Pop, Selecta, S, Sienna, SX	159.A2.000	52-56/71-76	01.1990	10.1995	RC 62 LS	A6	B17	0,9	L65
	1.4 ie S, SW	836.A4.000	51/69	10.1994	12.1996	RC 72 LS	A32	B26	0,7	L87
	1.6 ie	160.A2.000	60-63/82-86	07.1987	10.1995	RC 72 LS	A32	B26	0,7	L87
	1.6 ie	149.C2.046 [DOHC]	66/90	02.1988	06.1990	RC 62 LS	A6	B17	0,9	L65
	1.6 ie Selecta	835.C1.000	55-60/75-82	01.1993	10.1995	RFN 62 LZ	A71		0,9	F86
	1.6 ie SX, Perfect, Selecta	159.A3.000	58-61-63/79-83-86	04.1990	10.1995	RC 72 LS	A32	B26	0,7	L87
	1.6 ie SX, Selecta	159.A3.046 - 159.A3.048	55-66/75-90	03.1990	10.1995	RC 72 LS	A32	B26	0,7	L87
	1.8 ie 16V	160.A5.000	100/136	06.1989	09.1991	RC 72 LS	A32	B26	0,7	L87
	1.8 ie 16V GT, SX, SLX	835.C2.000 Cat	76/103	11.1991	10.1995	RC 72 LS	A32	B26	0,7	L87
	1.8 ie SX, SLX	159.A4.000	81/110	06.1989	03.1992	RC 72 LS	A32	B26	0,7	L87
	2.0 i, ie 16V	836.A3.000 Cat	102/139	05.1991	10.1995	RC 72 LS	A32	B26	0,7	L87
	2.0 ie 16V	160.A8.046	104-107-109/ 141-146-148	12.1990	10.1995	RC 72 LS	A32	B26	0,7	L87
ULYSSE	1.8	LFW	73/99	05.1997	08.2002	RFN 52 LZ	A27		0,9	F54
	1.8 i S, EL	XU7 JP [LFW]	76/103	05.1996		RFC 58 LZK (a)	A11	B29	0,9	F54
	1.8 i S, EL	XU7 JP [LFW]	76/103	05.1996		RFN 58 LZ (b)	A7	B28	0,9	F54
	1.8 i S, EL	XU7 JP [LFW]	76/103	05.1996		RFN 58 LZ3A (g)	A515		0,9	
	2.0	RFU (XU10J2C)	89/121	06.1994	08.2002	RFN 52 LZ	A27		0,9	F54
	2.0 16V	RFV	97/132	05.1998	09.2000	RFN 52 LZ	A27		0,9	F54
	2.0 i 16V	EW10 J4-L4 [RFN] [DOHC]	100/136	06.2002		RFN 52 HZ	A157	B50	0,9	
	2.0 i 16V	EW10 J4-L4 [RFN] [DOHC]	100/136	06.2002		RFN 52 HZ3A (g)	A100		0,9	

(1) Available until end of stock

(a) 30 000 km

(b) 60 000 km

(c) Grey sticker on ignition coil

(d) Green sticker on ignition coil

(e) Hex 21 mm

(f) Hex 16 mm

(g) Recommended for cold weather

(g) Recommended for cold weather

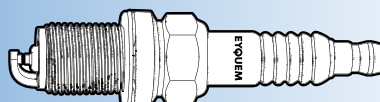

EYQUEM



Box
10

Blister
4



F3 → 1

FIAT										
	2.0 i S, EL	XU10 J2C [RFU]	89/121	07.1994		RFC 58 LZK (a)	A11	B29	0,9	F54
	2.0 i S, EL	XU10 J2C [RFU]	89/121	07.1994		RFN 58 LZ (b)	A7	B28	0,9	F54
	2.0 i S, EL	XU10 J2C [RFU]	89/121	07.1994		RFN 58 LZ3A (g)	A515		0,9	
	2.0 i Turbo	XU10 J2TE [RGX]	107/145	07.1994		RFN 58 LZ (b)	A7	B28	0,9	F54
	2.0 i Turbo	XU10 J2TE [RGX]	107/145	07.1994		RFN 58 LZ3A (g)	A515		0,9	
	2.0 Turbo	RGX (XU10J2CTE)	108/147	06.1994	06.1995	RFC 62 LS	A48		0,7	F86
	2.0 Turbo	RGX (XU10J2CTE)	108/147	07.1995	08.2002	RFN 52 LZ	A27		0,9	F54
	3.0 V6	XFW	150/204	08.2002		RFN 42 HZDP5	A184		0,9	
UNO	0.9 45, ES, Pop, S, Sting	146.A	33/45	01.1983	09.1992	RC 62 LS	A6	B17	0,7	L65
	1.0 ie	146.C7.000	35/48	09.1993	04.1994	RC 62 LS	A6	B17	0,7	L65
	45 i.e. 1.0	156.A2.246	33/45	04.1984	12.1994	RFN 52 LZ	A27		0,9	F54
	1.0 ie 45	156.A2.100 - 156.A2.246 - 156.A2.048 - 156.A2.146	32-33/44-45	06.1985	12.1995	RFC 52 LS	A3	B16	0,8	F54
	1.0 Trend	146.B4.000	32/44	07.1990	03.1994	RC 62 LS	A6	B17	0,7	L65
	1.1 55, S	138.B.000	41/56	01.1983	04.1985	RC 62 LS	A6	B17	0,7	L65
	1.1 60	146.C3.000	36/49	01.1993	04.1994	RFC 52 LS	A3	B16	0,8	F54
	1.1 60, S, Selecta, SL, Van CS	146.A6.000 - 146.A4	43/58	05.1985	10.1995	RC 62 LS	A6	B17	0,7	L65
	1.1 60, S, SX, Perfect	160.A3.000	41-42/56-57	09.1989	09.1992	RFC 52 LS	A3	B16	0,8	F54
	1.1 ie 1.1 50 ie Fire, 60 ie Fire	160.A...	37/50	09.1989	12.1993	RFC 52 LS	A3	B16	0,8	F54
	1.1 ie 60, Hobby, S	156.C.046 Cat	37-42/50-57	09.1985	10.1995	RFN 58 LZ (b)	A7	B28	0,9	F54
	1.1 ie 60, Hobby, S	156.C.046 Cat	37-42/50-57	09.1985	10.1995	RFN 58 LZ3A (g)	A515		0,9	
	1.3 70, S, SL, SX, Matic, Super	138.B2.000	52/71	01.1983	12.1989	RC 62 LS	A6	B17	0,7	L65
	1.3 70, S, SL, SX, Matic, Super	149.A7	48/65	05.1985	08.1989	RC 62 LS	A6	B17	0,7	L65
	1.3 ie Turbo	146.A2.000 - 146.A2.146 - 146.A2.246	73-77/99-105	04.1985	03.1991	RFC 62 LS3X	A59		0,9	F86
	1.4 ie 70 ie, Selecta, ie Selecta, SX	160.A1.046 - 146.C1.000	41-51/56-69	01.1985	10.1995	RC 62 LS	A6	B17	0,7	L65
	1.4 ie Turbo	146.AB/A8.000	82-85/112-116	09.1989	12.1993	RFC 62 LS3X	A59		0,9	F86
	1.4 Racing	146.A8.046	82-85/112-116	09.1989	03.1994	RFC 62 LS3X	A59		0,9	F86
	1.5 ie 75 ie, S, SX	138.C2... Cat	55/75	01.1983	10.1987	RC 62 LS	A6	B17	0,7	L65
	1.5 ie 75 ie, S, SX, ie Selecta	149.C1.000 Cat	55/75	09.1987	10.1995	RC 72 LS	A32	B26	0,7	L87
X 1/9	1.3 1300			01.1973	12.1989	RC 72 LS	A32	B26	0,7	L87
	1.5 1500			01.1973	12.1989	RC 72 LS	A32	B26	0,7	L87

FISSORE										
MAGNUM 4x4	2.0 Volumex	132 GB...		07.1984	12.1985	C 62 LS	A4	B5	0,7	L65
	2.0 Volumex	132 E.000		01.1986	03.1988	RC 72 LS	A32	B26	0,7	L87
	2.5 ie V6 VIP	019.11 Cat	110/150	03.1986	03.1988	C 62 LS	A4	B5	0,7	L65
RAYTON 4x4	3.5 ie		155/211	03.1988		C 62 LS	A4	B5	0,7	L65

FORD										
A	2.0 0307, 0407, 0507	NX V4 ESX 1V	48/65	01.1986		RC 62 LS	A6	B17	0,6	L65
	2.0 0407	NAT	57/78	01.1986		RKC 62 JS	A29		0,6	
	3.0 V6 0310, 0510, 0610	HXB - HXC V6 ESX 1V	78/106	01.1986		RC 62 LS	A6	B17	0,6	L65
B-MAX	1.4		66/90	10.2012		RC 62 HJS6	A182	B57	1,3	
	1.6		77/105	10.2012		RC 62 HJS6	A182	B57	1,3	
CAPRI	1.3	J1E - J2F - J2N - J3C - J3N - JSD		12.1968	07.1987	RC 62 LS	A6	B17	0,7	L65
	1.6	LAC - LAN - LCE - LCN - LEN		08.1972	07.1987	RKC 62 JS	A29		0,7	
	2.0	NE3 - NEE - NEN HC	72-74/98-100	01.1974	04.1987	RKC 62 JS	A29		0,7	
	2.0 V6	NYL HC / LC	66/90	05.1976	07.1987	RC 72 LS	A32	B26	0,7	L87
	2.3 V6	YYN HC	84/114	04.1969	04.1987	RC 82 LS	A78		0,7	L87
	2.8 i Turbo	PYN	138/188	01.1981	04.1987	RC 82 L	A94		0,7	
	2.8 i V6	RRN	118/160	11.1979	04.1987	RC 82 LS	A78		0,7	L87
	3.0 V6	HYF HC	101/137	12.1968	08.1981	RC 62 LS	A6	B17	0,7	L65
C-MAX	1.6	HWDA/HWDB/SHDA/SHDB/SHDC	74/101	02.2007		RC 62 HJS6	A182	B57	1,3	
	1.8	QQDC	90/122	02.2007		RN 62 LJZEDP6	A505		1,3	
	1.8	QQDA/QQDB	92/125	02.2007		RN 62 LJZEDP6	A505		1,3	
	1.8 Flexifuel	Q7DA	92/125	02.2007		RN 62 LJZEDP6	A505		1,3	
	2.0	AODA/AODB/SYDA/AODE	107/145	02.2007		RN 62 LJZDP6	A503		1,3	
	2.0 CNG	SYDA	107/145	04.2009		RN 62 LJZDP6	A503		1,3	
	2.0 LPG	SYDA	107/145	06.2008		RN 62 LJZDP6	A503		1,3	
C-MAX II	1.6 Ti	IQDA/IQDB	77/105	12.2010		RC 62 HJS6	A182	B57	1,3	
CORTINA	1.3	KL 13 H - KL 13 L [OHV]		01.1969	10.1982	RC 72 LS	A32	B26	0,8	L87

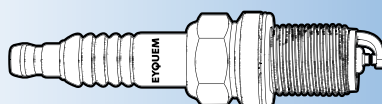

(1) Available until end of stock
 (a) 30 000 km
 (b) 60 000 km
 (c) Grey sticker on ignition coil
 (d) Green sticker on ignition coil

(e) Hex 21 mm
 (f) Hex 16 mm
 (g) Recommended for cold weather



KW/HP



Box
10

Blister
4



F3→1

FORD

	1.6 Base, L, GL, GHIA GT	TL 16 H/L [OHC]	50-53/68-72	01.1970	10.1982	RKC 62 JS	A29		0,8	
	2.0 GT	TL 20 H [OHC]	72/98	01.1970	10.1982	RKC 62 JS	A29		0,8	
	2.3 V6	TV 23 H [OHV]	79/107	02.1977	10.1982	RC 72 LS	A32	B26	0,8	L87
COUGAR	2.0 i 16V	NGA Zetec [DOHC]	96/131	04.1998		RC 62 HJSP	A181	B53	1,0	
	2.0 i 16V	EDBA Zetec [DOHC]	96/131	06.1998		RC 62 HJSP	A181	B53	1,0	
	2.0 i 16V	EDBC - EDBD Zetec [DOHC]	96/131	08.1998		RC 62 HJSP	A181	B53	1,0	
COURIER	1.3 Combi, Van	[HCS]	44/60	09.1991		RC 52 LJS5	A74	B56	1,0	
	1.3 i Combi, Van	J6B	44/60	09.1991		RC 52 LJS5	A74	B56	1,0	
	1.4 i		66/90	04.1996	10.1999	RC 62 HJS6	A182	B57	1,3	
ESCORT	1.0 1000	KL 09 G [OHV]		12.1974	08.1980	RC 62 LS	A6	B17	0,7	L65
	1.1 1100	KL 11 E/G/H/L [OHV]		08.1970	08.1980	RC 62 LS	A6	B17	0,7	L65
	1.3 1300, Combi, Van	KL 13 L [OHV]		08.1968	08.1980	RC 62 LS	A6	B17	0,7	L65
	1.3 1300, GT	KL 13 G - KL 13 H [OHV]		08.1968	08.1980	RC 72 LS	A32	B26	0,7	L87
	1.6 RS 1600	LC KL 16 G [OHV]		12.1974	08.1980	RC 72 LS	A32	B26	0,7	L87
	2.0 RS 2000	NE TL 20 H [OHC]	75-80/102-109	07.1973	08.1980	RKC 62 JS	A29		0,7	
ESCORT III	1.1	GPA W	43/58	08.1980	12.1985	RFC 82 LS	A76		0,7	F86
	1.1 Van 35, Van 55	GMA	40/54	08.1980	12.1985	RFC 62 LS	A48		0,8	F86
	1.3	JGA	43/58	08.1980	12.1985	RFC 58 LS	A18		0,7	F54
	1.3 Express 55, Van 35, Van 55	JPA	51/69	08.1980	12.1985	RFC 62 LS	A48		0,8	F86
	1.6 LX	LGA	48/65	08.1980	12.1985	RFC 58 LS	A18		0,7	F54
	XR3 : 1.6	LUA	71/97	08.1980	12.1985	RFC 82 LS	A76		0,7	F86
ESCORT III; IV	1.1 C Affaire, Express, Express 35, Van 35, Van 55	GSE - GSG - GLB	37-40/50-54	08.1980	07.1990	RC 52 LJS	A62	B27	0,7	J65
	1.6 i Cabrio, Turnier, XR3i	L4B	66/90	08.1980	07.1990	RFC 62 LS	A48		0,8	F86
	1.6 i Ghia/Salon, XR3i, XR3i Salon	LR1 - LR2 - LRA - LRB	77/105	08.1980	07.1990	RFC 82 LS	A76		0,7	F86
	1.6 i Turnier	LP2	58/79	08.1980	07.1990	RFC 82 LS	A76		0,7	F86
	1.6 Turnier	LP1 - LPA	58/79	08.1980	07.1990	RFC 82 LS	A76		0,7	F86
ESCORT IV	1.3 C, Turnier	JLA - JLB	44/60	01.1986	07.1990	RC 52 LJS	A62	B27	0,7	J65
	1.4	FUC	54/73	01.1986	07.1990	RFC 82 LS	A76		0,7	F86
	1.4, Kombi		51/69	10.1985	10.1990	RC 72 LS	A32	B26	0,7	L87
	1.4, Kombi	FUC	54/73	01.1986	07.1990	RFC 82 LS	A76		0,7	F86
	1.4 Cabrio, CL Affaire, Ghia/Salon, Scoop, Touring/Salon, Turnier	FUA	55/75	01.1986	07.1990	RFC 62 LS	A48		0,8	F86
	1.4 Cabriolet	FUC	54/73	02.1987	07.1990	RFC 82 LS	A76		0,7	F86
	1.4 i	FUC	54/73	02.1986	07.1990	RFC 82 LS	A76		0,7	F86
	1.4 i Cabrio, CL Affaire, Ghia/Salon, Scoop, Touring/Salon, Turnier	FUAA	51/69	01.1986	07.1990	RFC 62 LS	A48		0,8	F86
	1.4 i Cabrio, Turnier	F6B - F6D Cat	54/73	01.1986	07.1990	RFC 62 LS5	A42		1,0	F54-5
	XR3 : 1.6 i i Hawaii/Tennis	LJB - LJA	75-79/102-105	01.1986	07.1990	RFC 62 LS5	A42		1,0	F54-5
ESCORT IV-V-VI	1.1 Express	GUC - GUF [HCS]	40/54	01.1986	12.1994	RC 52 LJS5	A74	B56	1,0	
	1.3 Affaire, CLX Melody, CLX Touring, Touring, Turnier	JBB - JBD	44/60	01.1986	12.1994	RC 52 LJS5	A74	B56	1,0	
	1.3 i Affaire, CLX Melody, CLX Touring, Touring, Turnier	JBA [HCS] - JBE	46/63	01.1986	12.1994	RC 52 LJS5	A74	B56	1,0	
	1.4 Cabrio, CLX, Express, GL, Turnier	FUC - FUH	54/73	01.1986	12.1994	RFC 62 LS5	A42		1,0	F54-5
	1.6 Cabrio, CLX, Ghia/Salon, GL, Scoop, Success	LUD - LUG	65/88	01.1986	12.1994	RFC 62 LS	A48		0,8	F86
	1.6 i Cabrio, CLX, Ghia/Salon, GL, Scoop, Success	LUC - LUJ - LUK	66/90	01.1986	12.1994	RFC 62 LS	A48		0,8	F86
	1.6 i Touring/Salon, Turnier, Van	LUC - LUJ - LUK	66/90	01.1986	12.1994	RFC 62 LS	A48		0,8	F86
	1.6 Touring/Salon, Turnier, Van	LUD - LUG	65/88	01.1986	12.1994	RFC 62 LS	A48		0,8	F86
ESCORT V	1.4 i Express 55/75, Sunset, Touring, Tropical, Turnier	F4B	54/73	07.1990		RFC 58 LS5	A38	B48	1,1	F54-5
	1.6 i 16V Cabrio, CLX, L, LX, GHIA, GT, Sunset, Tropical, Turnier, 4x4	L1E Zetec [DOHC]	66/90	08.1990		RC 62 HJSP	A181	B53	1,0	
	1.6 i 16V Cabrio, Turnier, XR3i Cabrio	L1H - L1K Zetec [DOHC]	65-66/88-90	08.1990		RC 62 HJSP	A181	B53	1,0	
	1.6 i Cabrio, i S, Turnier, XR3i	LJF - LJE	77-79/105-107	07.1990	09.1992	RFC 62 LS5	A42		1,0	F54-5
	2.0 i 16V RS 2000, RS 2000 4x4	N7A [DOHC]	110/150	08.1990		RFC 62 LS5	A42		1,0	F54-5
ESCORT V-VI	1.3 i CLX Melody, Express, Turnier	J6A [HCS]	44/60	07.1990	12.1994	RC 52 LJS5	A74	B56	1,0	
	1.4 i Cabrio, Express, GL, Malibu, Turnier	F6F - F6G	52/71	07.1990	12.1994	RFC 58 LS5	A38	B48	1,1	F54-5
ESCORT VI	1.8 i 16V	RDA - RQB Zetec [DOHC]	77-95/105-130	02.1992		RC 62 HJSP	A181	B53	1,0	
ESCORT VII	1.8 i 16V	RKA Zetec [DOHC]	85/115	03.1996		RC 62 HJSP	A181	B53	1,0	
	1.8 i 16V Turnier, XR3i Cabrio	RKC Zetec	85/115	01.1995		RC 62 HJSP	A181	B53	1,0	
FIESTA	1.0 Van	TKA - TKW	29/39	08.1981	08.1983	RC 52 LJS	A62	B27	0,7	J65

(f) Available until end of stock

(a) 30 000 km

(b) 60 000 km

(c) Grey sticker on ignition coil

(d) Green sticker on ignition coil

(e) Hex 21 mm

(f) Hex 16 mm

(g) Recommended for cold weather

(h) Recommended for cold weather



EYQUEM



Box
10

Blister
4



F3 → 1

FORD										
	1.1 Van	GLA - GLW	40/54	08.1981	08.1983	RC 52 LJS	A62	B27	0,7	J65
	1.3	KL 13 G [OHV]	49/67	08.1977	06.1981	RC 82 LS	A78		0,7	L87
	1.3	J3E	49/67	07.1981	08.1983	RFC 82 LS	A76		0,7	F86
	XR2 : 1.6	L3E	62/84	08.1981	08.1983	RFC 82 LS	A76		0,7	F86
	1.0 Express	TKA - TKW - TKB - TLA	29-33/39-45	05.1976	02.1989	RC 52 LJS	A62	B27	0,7	J65
	1.1	GUB - GSH - GLC - GSF - GL1 - GS1 - GLA - GLW - GL	35-41/48-56	05.1976	02.1989	RC 52 LJS	A62	B27	0,7	J65
FIESTA II	1.0 Express	TKA - TKW - TKB - TLA	29-33/39-45	05.1976	02.1989	RC 52 LJS	A62	B27	0,7	J65
	1.1	GUB - GSH - GLC - GSF - GL1 - GS1 - GLA - GLW - GL	35-41/48-56	05.1976	02.1989	RC 52 LJS	A62	B27	0,7	J65
	1.3	JPC	51/69	08.1983	01.1987	RFC 62 LS	A48		0,8	F86
	1.4 i	F6A - F6C Cat	52/71	10.1986	07.1988	RFC 62 LS5	A42		1,0	F54-5
	1.6	LP3	58/79	08.1983	02.1989	RFC 82 LS	A76		0,7	F86
	XR2 : 1.6	LUB - LUD	70-71/95-97	08.1983	02.1989	RFC 82 LS	A76		0,7	F86
FIESTA II; III	1.4 CLX, Ghia, Urba	FUB - FUF	55/75	08.1983	06.1996	RFC 62 LS	A48		0,8	F86
FIESTA III	1.0	TLB	33/45	03.1989	06.1996	RC 52 LJS5	A74	B56	1,0	
	1.1 Affaire, C Festival, CL, CLX, CTX, Fun, Melody, Success	GUD - GUE	40/54	03.1989	06.1996	RC 52 LJS5	A74	B56	1,0	
	1.1 Claridge, Ghia, Super Festival, Urba	GUD - GUE	40/54	03.1989	06.1996	RC 52 LJS5	A74	B56	1,0	
	1.1 i Affaire, Claridge, CLX, Fun, Melody, Navy, Newport	G6A Cat	37/50	03.1989	06.1996	RC 52 LJS5	A74	B56	1,0	
	1.3	JLA	44/60	03.1989	06.1996	RC 52 LJS5	A74	B56	1,0	
	1.3 i	J6B - J6C	44/60	03.1989	06.1996	RC 52 LJS5	A74	B56	1,0	
	1.4 Ghia, Nordic Green	FUD - FUG - FUJ	54/73	02.1987	06.1996	RFC 62 LS5	A42		1,0	F54-5
	1.4 i	F6E - F4A Cat	52-54/71-73	03.1989	06.1996	RFC 58 LS5	A38	B48	1,1	F54-5
	1.6	LUH	66/90	03.1989	06.1996	RFC 62 LS	A48		0,8	F86
	1.6 i 16V	L1G Zetec [DOHC]	76/103	03.1994	06.1996	RC 62 HJS5	A181	B53	1,0	
	1.8 i 16V RS 1800 - XR2	RDA - RDB - RQC Zetec [DOHC]	77-96/105-130	02.1992	06.1996	RC 62 HJS5	A181	B53	1,0	
	XR2 : 1.6 i i	LJD - LJC Cat	76-81/103-110	03.1989	06.1996	RFC 62 LS5	A42		1,0	F54-5
FIESTA IV	1.25 i 16V	DHA - DHB - DHC - DHD - DHE - DHF - DHG Zetec [DOHC]	55/75	08.1995		RC 62 HJS6	A182	B57	1,3	
	1.3 i	Endura-E	36-44/49-60	08.1995		RC 52 LJS5	A74	B56	1,0	
	1.4 i 16V	FXJA - FHE Zetec - FHA Zetec [DOHC]	66/90	10.1995		RC 62 HJS6	A182	B57	1,3	
FIESTA IV; V	1.6 i 16V	L1T - L1V Zetec [DOHC]	76/103	02.2000		RC 62 HJS6	A182	B57	1,3	
FIESTA V	1.25 i 16V	M7JA/M7JB	51/69	03.2003		RC 62 HJS6	A182	B57	1,3	
	1.25 i 16V	FUJA/FUJB	55/75	05.2002		RC 62 HJS6	A182	B57	1,3	
	1.3	BAJA	44/60	11.2001		RC 62 HJS6	A182	B57	1,3	
	1.3	A9JA/A9JB	51/69	11.2001		RC 62 HJS6	A182	B57	1,3	
	1.4 i 16V	FXJB [DOHC] Cat	59/80	05.2002		RC 62 HJS6	A182	B57	1,3	
	1.6 i 16V	FYJA [DOHC] Cat	74/101	05.2002		RC 62 HJS6	A182	B57	1,3	
	ST150	N4JB	110/150	03.2005		RN 62 LJZDP6	A503		1,3	
FIESTA VI	1.25 i 16V	SJTA/SJTB	44/60	10.2008		RC 62 HJS6	A182	B57	1,3	
	1.25 i 16V	SNJA/SNJB	60/82	10.2008		RC 62 HJS6	A182	B57	1,3	
	1.4	SPJA/SPJC	71/97	10.2008		RC 62 HJS6	A182	B57	1,3	
	1.4 LPG	RTJA/RTJB	71/97	10.2008		RC 62 HJS6	A182	B57	1,3	
	1.6 Ti	IQJA	77/105	09.2012		RN 62 LJZDP6	A503		1,3	
	1.6 Ti	HXJA/HXJB	88/120	10.2008		RC 62 HJS6	A182	B57	1,3	
NEW	1.6 Ti	U5JA	99/134	12.2010		RC 62 HJS6	A182	B57	1,3	
FOCUS	1.4 i 16V	FXDA - FXDB - FXDC - FXDD Zetec [DOHC]	55/75	10.1998	11.2004	RC 62 HJS6	A182	B57	1,3	
	1.6 i 16V	FYDA - FYDB - FYDC - FYDD Zetec [DOHC]	74/101	10.1998	11.2004	RC 62 HJS6	A182	B57	1,3	
	1.8 i 16V	EYDB - EYDC - EYDD - EYDE - EYDF Zetec [DOHC]	85/115	10.1998	11.2004	RC 62 HJS6	A181	B53	1,0	
	2.0 i 16V	EDDB - EDCC - EDDD - EDDF Zetec [DOHC]	96/131	10.1998	11.2004	RC 62 HJS6	A181	B53	1,0	
FOCUS C-MAX	1.8	CSDB/CSDA	88/120	10.2003	03.2007	RN 62 LJZDP6	A503		1,3	
	2.0	AODA/AODB/SYDA	107/145	04.2004	03.2007	RN 62 LJZDP6	A503		1,3	
FOCUS II	1.4	ASDA/ASDB	59/80	11.2004		RC 62 HJS6	A182	B57	1,3	
	1.6	HWDA/HWDB/SHDA	74/101	11.2004		RC 62 HJS6	A182	B57	1,3	
	1.6 Ti	HXDA/HXDB	85/115	11.2004		RC 62 HJS6	A182	B57	1,3	
	1.8	QQDB	92/125	03.2006		RN 62 LJZDP6	A503		1,3	
	1.8 Flexifuel	Q7DA	92/125	01.2006		RN 62 LJZDP6	A503		1,3	

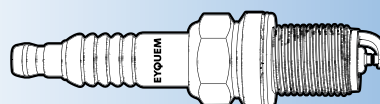

- (1) Available until end of stock
 (a) 30 000 km
 (b) 60 000 km
 (c) Grey sticker on ignition coil
 (d) Green sticker on ignition coil

- (e) Hex 21 mm
 (f) Hex 16 mm
 (g) Recommended for cold weather



KW/HP



Box
10

Blister
4



F3 →

FORD

	2.0	AODA/AODB	107/145	11.2004		RN 62 LJZDP6	A503		1.3	
	2.0 LPG	SYDA	107/145	06.2008		RN 62 LJZDP6	A503		1.3	
	2.0 CNG	SYDA	107/145	04.2009		RN 62 LJZDP6	A503		1.3	
FUSION	1.25	FUJA	55/75	08.2004		RC 62 HJS6	A182	B57	1,3	
	1.25	FUJB	55/75	08.2004		RC 62 HJS6	A182	B57	1,3	
	1.4	FXJA	59/80	08.2002		RC 62 HJS6	A182	B57	1,3	
	1.4	FXJB	59/80	08.2002		RC 62 HJS6	A182	B57	1,3	
	1.6	FYJA	74/101	08.2002		RC 62 HJS6	A182	B57	1,3	
GALAXY	2.0 i	NSE	85/115	02.1995		RFN 62 LZ	A71		1,0	F86
	2.3 16V	Y5B, E5SA	107/145	01.1997		RFN 42 LZP	A194		0,8	
	2.3 i 16V	Y5B	108/147	08.1996		RFN 58 LZ (b)	A7	B28	1,0	F54
	2.3 i 16V	Y5B	108/147	08.1996		RFN 58 LZ3A (g)	A515		1,0	
	2.8 i V6	AAA	128/174	02.1995		RFC 42 LZ4E	A154		1,6	
	2.8 i V6	AYL [DOHC] Cat	150/204	04.2000		RFN 52 LZDPF5	A153		1,0	
GALAXY II	2.0	AOWB/AOWA	107/145	05.2006		RN 62 LJZEDP6	A505		1.3	
GRANADA	1.6	LCK W HC [OHC]	55/75	08.1981	08.1985	RKC 62 JS	A29		0,7	
	1.7 i Turnier	NWB - MYE	52-54/71-73	06.1979	08.1981	RC 72 LS	A32	B26	0,7	L87
	1.8	REC [OHC]	66/90	05.1985	10.1994	RKC 62 JS	A29		0,7	
	2.0	NE4 - NER - NEL [OHC]	74-77/100-105	05.1985	10.1994	RKC 62 JS	A29		0,7	
	2.0	N8B - N8D [DOHC]	77-80/105-109	05.1985	10.1994	RFC 58 LS	A18		0,8	F54
	2.0 i	NR1 - NRA - NRC [OHC]	74-85/100-115	05.1985	10.1994	RKC 62 JS	A29		0,7	
	2.0 i	N9D - N9B - N9F [DOHC]	85-90/115-122	05.1985	10.1994	RFC 62 LS	A48		0,7	F86
	2.0 i Turnier	NE2 - NEC - NEP - NEK [OHC]	72-77/98-105	08.1977	08.1985	RKC 62 JS	A29		0,7	
	2.0 V6 Turnier	NYU - NYP	64-66/87-90		08.1985	RC 62 LS	A6	B17	0,7	L65
	2.3 V6	YYU - YYP	82-84/112-114	06.1979	08.1985	RC 62 LS	A6	B17	0,7	L65
	2.3 V6 Turnier	TV 23 H [OHV]		06.1979	08.1985	RC 72 LS	A32	B26	0,7	L87
	2.4 i V6	ARD	92/125	05.1985	12.1994	RC 52 LJS5	A74	B56	1,0	
	2.4 i V6	ARC	96/131	05.1985	10.1994	RFC 58 LS	A18		0,8	F54
	2.6	TV 26 L	79/107	08.1977	08.1985	RC 72 LS	A32	B26	0,7	L87
	2.8 i	TV 28 I			08.1985	RC 72 LS	A32	B26	0,7	L87
	2.8 i V6	PRD - PRC - PRE - PYU - PYA	97-110/131-150	08.1981	08.1985	RC 62 LS	A6	B17	0,7	L65
	2.8 i V6	PR4 - PR3 - PR2	105-110/143-150	04.1985	10.1994	RC 62 LS	A6	B17	0,7	L65
	2.9 i V6	BRD - BRE - BRF	107/145	05.1985	10.1994	RC 52 LJS5	A74	B56	1,0	
	2.9 i V6	BRC	110/150	05.1985	10.1994	RFC 58 LS	A18		0,8	F54
KA	1.0 i		38/52	07.1997	09.1999	RC 52 LJS5	A74	B56	1,0	
	1.0 i		48/65	09.1999		RC 52 LJS5	A74	B56	1,0	
	1.3 i	Duratec 8V	43-50/58-68	09.1996		RC 62 HJS6	A182	B57	1,3	
	1.3 i	A9A/A9B	51/69	08.2002		RC 62 HJSP	A181	B53	1,3	
	1.3 i Déclit, Pack Electrique, Roller	J4D - J4K - JJA - JJB - JJD - Endura-E	36-37-44/49-50-60	09.1996		RC 52 LJS5	A74	B56	1,0	
	1.4 i 16V	FHA Zetec [DOHC]	66/90	01.1998		RC 62 HJS6	A182	B57	1,3	
	1.6 i	CDB/CDC	70/95	07.2003		RC 62 HJSP	A181	B53	1,3	
	1.7 i 16V	MHA SE Zetec [DOHC]	92/125	01.1998		RC 62 HJSP	A181	B53	1,0	
KA II	1.2	FP4	51/69	02.2009		RZC 62 LSE	A510		1,0	
MAVERICK	2.0 16V		91/124	02.2001	12.2003	RC 62 HJSP	A181	B53	1,3	
	2.3 16V	GZ	110/150	03.2004		RN 62 LJZDP6	A503		1.3	
	3.0 V6 24V		145/197	02.2001		RC 72 LJS	A88		0,6	J87
MONDEO I	1.6 i 16V	L1F - L1J Zetec [DOHC]	66/90	01.1993	08.1996	RC 62 HJSP	A181	B53	1,0	
	2.0 i 16V	NGA Zetec [DOHC]	96/131	01.1993	11.2000	RC 62 HJSP	A181	B53	1,0	
MONDEO II	1.6 i 16V	L1N - L1Q - L1L Zetec [DOHC]	66-70/90-95	05.1998	11.2000	RC 62 HJSP	A181	B53	1,0	
	1.8 i 16V	RKA - RKB - RKH - RKF - RKJ - RKK Zetec [DOHC]	85/115	07.1994	11.2000	RC 62 HJSP	A181	B53	1,0	
	2.0 i 16V	NGB - NGC - NGD Zetec [DOHC]	96/131	08.1996	11.2000	RC 62 HJSP	A181	B53	1,0	
MONDEO III	1.8 16V	CGBB/CGBA	81/110	11.2000	08.2007	RN 62 LJZDP6	A503		1.3	
	1.8 16V	CHBA/CHBB	92/125	11.2000	08.2007	RN 62 LJZDP6	A503		1.3	
	2.0 16V	CJBA/CJBB	107/145	11.2000	08.2007	RN 62 LJZDP6	A503		1.3	
MONDEO IV	1.6 Ti	RHBA	81/110	03.2007		RC 62 HJS6	A182	B57	1,3	
	1.6 Ti		88/120	07.2010		RC 62 HJS6	A182	B57	1,3	
	1.6 Ti	PNBA	92/125	03.2007		RC 62 HJS6	A182	B57	1,3	
	2.0	AOBC/AOBA	107/145	03.2007		RN 62 LJZEDP6	A505		1.3	
	2.0 Flexifuel	TBBB/TBBA	107/145	03.2007		RN 62 LJZEDP6	A505		1.3	
ORION I; II	1.6 i	L4B	66/90	05.1983	07.1990	RFC 62 LS	A48		0,8	F86
	1.6 i	LR1 -LRA - LRB	77/105	05.1983	07.1990	RFC 82 LS	A76		0,8	F86

(1) Available until end of stock

(a) 30 000 km

(b) 60 000 km

(c) Grey sticker on ignition coil

(d) Green sticker on ignition coil

(e) Hex 21 mm

(f) Hex 16 mm

(g) Recommended for cold weather



EYQUEM



Box
10

Blister
4



F3

FORD										
ORION II	1.3	JLA	44/60	12.1985	07.1990	RC 52 LJS	A62	B27	0,6	J65
	1.3	JLB	44/60	12.1985	07.1990	RC 52 LJS	A62	B27	0,6	J65
	1.3	JLA - JLB	44/60	01.1986	12.1988	RC 52 LJS5	A74	B56	1,0	
	1.4		52/71	08.1988	07.1990	RFC 52 LS5	A26	B24	1,1	F54-5
	1.4 CL, Ghia/Salon, Scoop/Salon, Touring/Salon	FUA	55/75	01.1986	07.1990	RFC 62 LS	A48		0,8	F86
	1.4 i	F6B - F6D Cat	54/73	01.1986	07.1988	RFC 62 LS5	A42		1,0	F54-5
	1.4 KAT	F6B/F6D	54/73	08.1988	07.1990	RFC 52 LS5	A26	B24	1,1	F54-5
ORION II; III	1.3 Touring	JBB - JBD - JBE	44-46/60-63	01.1986	12.1993	RC 52 LJS5	A74	B56	1,0	
	1.4 CLX, GL	FUH	54/73	01.1986	12.1993	RFC 62 LS5	A42		1,0	F54-5
	1.6	LUC - LUG - LUJ - LUK	66/90	04.1986	12.1993	RFC 62 LS	A48		0,8	F86
	1.6 i	LJA - LJB - LJE - LJF	75-79/102-107	01.1986	07.1993	RFC 62 LS5	A42		1,0	F54-5
ORION III	1.3 i	J6A [HCS]	44/60	08.1990	12.1993	RC 52 LJS5	A74	B56	1,0	
	1.4	F6F/F6G	52/71	07.1990	12.1993	RFC 52 LS5	A26	B24	1,1	F54-5
	1.6 i 16V	L1E Zetec [DOHC]	66/90	08.1990	12.1993	RC 62 HJSP	A181	B53	1,0	
	1.8 i 16V	RDA - RQB Zetec [DOHC]	77-95/105-130	08.1990	12.1993	RC 62 HJSP	A181	B53	1,0	
P	2.0	NAE	57/78	10.1987		RKC 62 JS	A29		0,7	
P 100	1.6	LCR	54/73	04.1982	09.1987	RKC 62 JS	A29		0,7	
PROBE	2.0 i 16V	FS [A EFI] [DOHC]	86/117	08.1992		RFC 62 LS5	A42		1,1	F54-5
	2.5 i V6 24V	KL [B EFI]	120/163	08.1992		RFC 58 LZ5	A75		1,1	F54-5
	3.0 i V6 GT	[U] Cat	108/147	02.1990		RC 52 LJS5	A74	B56	1,1	
PUMA	1.4 i 16v	FHD, FHF, Zetec [DOHC]	66/90	06.1997	11.2000	RC 62 HJS6	A182	B57	1,3	
	1.6 i 16v	L1W	75/102	06.1997	08.2000	RC 62 HJS6	A182	B57	1,3	
	1.7 i 16V	MHA, MHB, SE Zetec [DOHC]	92/125	04.1997		RC 62 HJSP	A181	B53	1,0	
RANGER	4.0 i V8	6V [U] Cat	115/156	09.1990		RC 22 LJZ7 (1)	A129		1,5	
SCORPIO	1.8	REC [OHC]	66/90	04.1985	02.1992	RKC 62 JS	A29		0,8	
	2.0	NE4 - NER - NEL [OHC]	74-77/100-105	04.1985	08.1989	RKC 62 JS	A29		0,8	
	2.0	NEL	77/105	04.1985	08.1989	RKC 62 JS	A29		0,8	
	2.0	N8D - N8B [DOHC]	77-80/105-109	05.1989	02.1992	RFC 58 LS	A18		0,8	F54
	2.0 i	NRA - NRC - NRI [OHC]	74-85/-100-115	04.1985	02.1992	RKC 62 JS	A29		0,8	
	2.0 i	NRA/NRI	85/115	04.1985	02.1992	RKC 62 JS	A29		0,8	
	2.0 i	NRC	74/101	10.1985	12.1990	RKC 62 JS	A29		0,8	
	2.0 i	N9D - N9B [DOHC]	88-90/120-122	05.1989	12.1994	RFC 62 LS	A48		0,7	F86
	2.0 i	N9F - NSD [DOHC]	85/115	02.1992	12.1998	RFC 62 LS	A48		0,7	F86
	2.0 i 16V	N3A	100/136	10.1994	12.1998	RFN 58 LZ (b)	A7	B28	1,0	F54
	2.0 i 16V	N3A	100/136	10.1994	12.1998	RFN 58 LZ3A (g)	A515		1,0	
	2.3 i 16V	Y5A	108/147	05.1996	12.1998	RFN 58 LZ (b)	A7	B28	1,0	F54
	2.3 i 16V	Y5A	108/147	05.1996	12.1998	RFN 58 LZ3A (g)	A515		1,0	
	2.4 i V6	ARC	96/131	05.1985	06.1989	RFC 58 LS	A18		0,8	F54
	2.4 i V6	ARD	92/125	08.1988	12.1994	RC 52 LJS5	A74	B56	1,0	
	2.9 i V6	BRD - BRE	107/145	05.1985	10.1994	RC 52 LJS5	A74	B56	1,0	
	2.9 i V6	BRG	110/150	10.1994	06.1998	RC 22 LJZ7 (1)	A129		1,5	
	2.9 i V6 24V	BOA	143/194	02.1991	12.1994	RFC 52 LZDP5	A149		1,1	
	2.9 i V6 24V	BOB	152/207	10.1994	12.1998	RFN 58 LZ (b)	A7	B28	1,0	F54
	2.9 i V6 24V	BOB	152/207	10.1994	12.1998	RFN 58 LZ3A (g)	A515		1,0	
	XR4 : 2.8 i V6 i 4x4	PR3 - PR4 - PRE	105-110/143-150	04.1985	10.1994	RC 62 LS	A6	B17	0,7	L65
	XR4 : 2.9 i V6 i 4x4	BRD, BRE, BRF	107/145	05.1985	12.1994	RC 52 LJS5	A74	B56	1,0	
	XR4 : 2.9 i V6 i 4x4	BRC	110/150	05.1985	02.1992	RFC 58 LS	A18		0,8	F54
	XR4 : 2.9 i V6 i 4x4	BRG	110/150	10.1994	12.1998	RFC 58 LS5	A38	B48	1,1	F54-5
SIERRA	1.3	JCT	44/60	08.1982	01.1987	RKC 62 JS	A29		0,7	
	1.6,Kombi	LSE	55/75	01.1987	02.1993	RKC 62 JS	A29		0,7	
	1.6,Kombi	LSF	53/72	01.1988	02.1993	RKC 62 JS	A29		0,7	
	1.6 i CL, CL Affaire, Turnier	LSDA - LSD - LES	51-55/69-75	08.1982	02.1993	RKC 62 JS	A29		0,7	
	1.6 i Turnier	LCS - LCT	55/75	08.1982	01.1987	RKC 62 JS	A29		0,7	
	1.6 i Turnier	LSF	53/72	01.1988	02.1993	RKC 62 JS	A29		0,7	
	1.6 i Turnier	L6B	59/80	10.1989	02.1993	RFC 58 LS5	A38	B48	1,1	F54-5
	1.8,Kombi	REB	66/90	10.1984	12.1986	RKC 62 JS	A29		0,7	
	1.8,Kombi	RED/REF	59/80	10.1987	09.1989	RKC 62 JS	A29		0,7	
	1.8 i CL, CL Affaire, CLX, GL, Laser, Turnier	R6A - R2C - R2A	63-66/86-90	05.1988	02.1993	RFC 58 LS5	A38	B48	1,1	F54-5
	1.8 i Turnier	REF - REB - RED	59-66/80-90	10.1984	12.1992	RKC 62 JS	A29		0,7	
	2.0,Kombi	NRD	74/101	10.1985	12.1986	RKC 62 JS	A29		0,7	
	2.0,Kombi	N8C/NES	77/105	01.1987	02.1993	RKC 62 JS	A29		0,7	
	2.0 i,Kombi	NE5/NEJ	74/101	01.1987	12.1989	RKC 62 JS	A29		0,7	

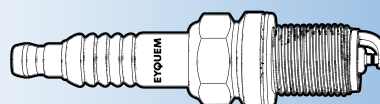

(1) Available until end of stock

- (a) 30 000 km
- (b) 60 000 km
- (c) Grey sticker on ignition coil
- (d) Green sticker on ignition coil

- (e) Hex 21 mm
- (f) Hex 16 mm
- (g) Recommended for cold weather



KW/HP



Box
10

Blister
4



F3

FORD

	2.0 i CLX 4x4, Ghia, GL, GLS, S Pack, Turnier, XR 4x4, 4x4	N9A - N9C - N9E	85-90/115-122	05.1989	02.1993	RFC 62 LS	A48		0,7	F86
	2.0 i CLX, Ghia, GL, GT, Manhattan, Turnier	N8A - N8C	77-80/105-109	05.1989	02.1993	RFC 58 LS	A18		0,7	F54
	2.0 i GL, Turnier	NR2 - NRB	85/115	03.1985	01.1987	RKC 62 JS	A29		0,7	
	2.0 i KAT, Kombi	N4B	74/101	01.1987	02.1993	RKC 62 JS	A29		0,7	
	2.0 i Turnier	NA - NA1 - N1ES - NE - NE1 - NE5 - NEJ - NES - NET	67-77/91-105	08.1982	02.1993	RKC 62 JS	A29		0,7	
	2.0 i Turnier	N4B - NRD	74/101	10.1985	02.1993	RKC 62 JS	A29		0,7	
	2.0 i Turnier	N4A - N4I	85/115	01.1987	02.1993	RKC 62 JS	A29		0,7	
	2.0 V6 Turnier	NYT	66/90	08.1982	01.1987	RC 62 LS	A6	B17	0,7	L65
	2.0 16V Cosworth 4x4	N5D	162/220	01.1990	02.1993	RFC 62 LSDP5	A507		1,1	
	2.0 16V Cosworth 4x4 KAT	N5C	162/220	01.1990	02.1993	RFC 62 LSDP5	A507		1,1	
	2.3 V6 Turnier	YYT	84/114	08.1982	01.1987	RC 62 LS	A6	B17	0,7	L65
	2.8 i V6 4x4 Turnier, XR4, XR4 Turnier, XR 4x4	PR	105-111/143-151	03.1985	08.1988	RC 62 LS	A6	B17	0,7	L65
	2.9 i V6 Turnier, XR 4x4	B4B, B4C	107/145	01.1987	12.1992	RC 22 LJZ7 (1)	A129		1,5	
	2.9 i V6 XR 4x4, Turnier 4x4	B4A	110/150	08.1988	02.1993	RFC 58 LS	A18		0,7	F54
S-MAX	2.0	AOWB/AOWA	107/145	05.2006		RN 62 LJZEDP6	A505		1,3	
	2.0 Flexifuel	TBWA/TBWB	107/145	05.2006		RN 62 LJZEDP6	A505		1,3	
STREET KA	1.6 i	CDRA/CDRB	70/95	05.2003		RC 62 HJS6	A182	B57	1,3	
TOURNEO	1.8 16V, Connect		85/115	09.2002		RC 62 HJSP	A181	B53	1,3	
TRANSIT	1.5 FT75, FT100	V4 Taunus	44/60	04.1971	03.1978	C 62 LS	A4	B5	0,6	L65
	1.6 80, 100L, 120, 130, 190	LAC - LAT	46/63	11.1985	09.1991	RKC 62 JS	A29		0,7	
	1.6 FT80, FT100, FT120	B [OHC]	48/65	04.1978	12.1985	RKC 62 JS	A29		0,7	
	1.7 FT100, FT120, FT130, FT160, FT175, FT190	V4 Essex	46/63	04.1971	03.1978	C 62 LS	A4	B5	0,6	L65
	1.8 16V Connect		85/115	09.2002		RC 62 HJSP	A181	B53	1,3	
	2.0	NAT/NAV	57/78	11.1985	09.1992	RKC 62 JS	A29		0,7	
	2.0	NBA	66/90	09.1991	09.1994	RKC 62 JS	A29		0,7	
	2.0 80, 100L, 120, 130, 190	NAV - NAT - NAW - NAX	55-57/75-78	02.1978	09.1991	RKC 62 JS	A29		0,7	
	2.0 FT 100, 120, 130, 160, 190	C [OHC]	55-57/75-78	04.1978	12.1985	RKC 62 JS	A29		0,7	
	2.0 i	NCA	72/98	09.1991	07.1994	RKC 62 JS	A29		0,7	
	2.0 i 80, 100, 120, 150, 190	NSF - NSG	84/114	08.1994		RFN 62 LZ	A71		1,0	F86
	2.0 i 80, 100L, 120, 130, 190	N6T	57-60/78-82	01.1986	09.1991	RKC 62 JS	A29		0,7	
	2.0 i LWB 100-190, SWB 80-150	NCA	72/98	08.1991	10.1994	RKC 62 JS	A29		0,7	
	2.0 KAT	N6T	57/78	12.1985	09.1992	RKC 62 JS	A29		0,7	
	2.0 LWB 100-190, SWB 80-150	NBA	66/90	08.1991	10.1994	RKC 62 JS	A29		0,7	
	2.3 16V	E5FA	107/145	04.2001		RFC 62 LS	A48		0,7	F86
	2.9 i V6	BRT	104-107/141-146	01.1986	10.1994	RFC 58 LS5	A38	B48	1,1	F54-5
	2.9 i V6	B4T	110/150	01.1986	07.1991	RFC 58 LS	A18		0,8	F54
	3.0 V6	HX - HXC-LC	74-78/100-106	01.1978	09.1991	RC 62 LS	A6	B17	0,7	L65

FORD (USA)

AEROSTAR	3.0 i V6		108/147	03.1986	12.1997	RC 52 LJS5	A74	B56	1,1	
PROBE I	2.2 GT		108/147	08.1988	12.1992	RFC 58 LZE5	A75		1,1	F54-5

FREIGHT ROVER

SHERPA	1.6	[OHV]		01.1973	12.1978	RC 62 LS	A6	B17	0,8	L65
	1.7	[OHV]	45/61	01.1978	12.1986	RC 52 LJS	A62	B27	0,8	J65
	1.7	[OHV]	45/61	01.1987	12.1989	RC 62 LS	A6	B17	0,8	L65
	1.8	[OHV]		01.1973	12.1978	RC 62 LS	A6	B17	0,8	L65
	2.0	[OHV]	51/69	01.1978	12.1986	RC 52 LJS	A62	B27	0,8	J65
	2.0	[OHV]	51/69	01.1987	12.1989	RC 62 LS	A6	B17	0,8	L65
	3.5 V8		105/143	01.1986	12.1989	RC 52 LS	A9	B20	0,8	L65

FSO

125P	1.3			06.1968	02.1991	C 62 LS	A4	B5	0,7	L65
	1.5			06.1968	02.1991	C 62 LS	A4	B5	0,7	L65
	125 Pick-up					RC 62 LS	A6	B17	0,8	L65
126P	Bis			01.1987		RC 62 LS	A6	B17	0,8	L65
	P			01.1972	12.1982	C 62 LS	A4	B5	0,8	L65
132P	1.6				12.1978	C 62 LS	A4	B5	0,7	L65
	1.8				12.1978	C 62 LS	A4	B5	0,7	L65

- (1) Available until end of stock
- (a) 30 000 km
- (b) 60 000 km
- (c) Grey sticker on ignition coil
- (d) Green sticker on ignition coil

- (e) Hex 21 mm
- (f) Hex 16 mm
- (g) Recommended for cold weather



EYQUEM



Box
10

Blister
4



F3-1

FSO										
CINQUECENTO	0.7	170.A.000 - 170.A.046				RC 62 LS	A6	B17	0,8	L65
	0.9	170.A1.000	29/39			RC 62 LS	A6	B17	0,8	L65
	0.9 i, ie	170.A1.046	30/41			RC 62 LS	A6	B17	0,8	L65
	1.1 i	176.A6.000 - 176.B2.000	40/54			RFN 58 LZ (b)	A7	B28	0,9	F54
	1.1 i	176.A6.000 - 176.B2.000	40/54			RFN 58 LZ3A (g)	A515		0,9	
POLONEZ	1.3 Pick-Up, Truck			01.1978	06.1995	C 62 LS	A4	B5	0,7	L65
	1.4 i 16V	K 16 series [DOHC]	75/102	01.1993		RFC 58 LS	A18		0,8	F54
	1.5 i	Cat	60-68/82-92	07.1995		C 62 LS3X	A13	B15	0,8	L65
	1.5 Pick-Up, Truck			01.1978	06.1995	C 62 LS	A4	B5	0,7	L65
	1.6		56-64/76-87	05.1987		C 72 LS (1)	A30		0,7	L87
	1.6 i	Cat	60-64-68/82-87-92	07.1995		C 62 LS3X	A13	B15	0,8	L65
	2.0			01.1978		C 82 LS	A40	B6	0,7	L87
2.0 Caro	[OHC]	77/105	10.1992		RKC 62 JS	A29		0,8		

GAZ										
3105	3105			01.1992		RC 62 LS	A6	B17	0,7	L65
3302 / GASELLE	2.5	ZMZ 4025.10 - 4026.10	66-74/90-100	01.1993		C 42 S	A12	B7	0,7	N43
	2.5	ZMZ 4061.10	81/110	01.1993		RC 62 LS	A6	B17	0,7	L65
VOLGA	2.5 24			01.1973		C 42 S	A12	B7	0,7	N43
	2.5 2402			01.1973		C 42 S	A12	B7	0,7	N43
	2.5 3102	ZMZ 4062.10	110/150			RC 62 LS	A6	B17	0,7	L65
	2.5 3102	ZMZ 402.10	74/101			C 42 S	A12	B7	0,7	N43
	2.5 31029	ZMZ 4062.10	110/150			RC 62 LS	A6	B17	0,7	L65
	2.5 31029	ZMZ 402.10	74/101			C 42 S	A12	B7	0,7	N43

GEO										
METRO	1.0	3L [6]	41/56	08.1994		RC 52 LS5	A36	B38	1,1	L65-5
PRIZM	1.6	4A-FE	77/105	01.1990		RFC 42 LS5	A83		1,1	F54-5

GINETTA										
G21	1.7			08.1971	02.1981	C 62 LS	A4	B5	0,6	L65
G23	3.0			08.1980		RC 72 LS	A32	B26	0,6	L87
G34	2.0 i Turbo	B 204 FT Cat	140/190	03.1995		RC 72 LS	A32	B26	0,7	L87

HILLMAN										
AVENGER	1.3			01.1973	12.1976	RC 62 LS	A6	B17	0,8	L65
	1250, 1500, 1.6			01.1970	12.1976	RC 72 LS	A32	B26	0,8	L87

HINDUSTAN										
AMBASSADOR	1.5		40/54	01.1991		C 52 LS	A1	B1	0,8	L65
CONTESSA CLASSIC	1.5		37-40/50-54	03.1984	09.1994	C 52 LS	A1	B1	0,8	L65
	1.8		65/88	03.1984		RC 52 LS5	A36	B38	1,1	L65-5

HOLDEN										
APOLLO	2.0 16V [JK, JL]	3SF [DOHC]		09.1989	03.1993	RFC 52 LS5	A26	B24	1,1	F54-5
	2.0 i 16V [JK, JL]	3S-FE [DOHC] Cat	94/128	09.1989	03.1993	RFC 58 LZ5	A101		1,1	F54-5
	2.2 i 16V [JM, JP]	5S-FE [DOHC] Cat	100/136	04.1993	05.1997	RFC 58 LS5	A38	B48	1,1	F54-5
	3.0 i 24V [JM, JP]	3VZ-FE [DOHC] Cat	138/188	04.1993	03.1997	RFC 52 LZDP5	A149		1,1	
ASTRA	1.6 i [TR]	C 16 SE [DOHC]	74/101	08.1996	09.1998	RC 52 LS (e)	A9	B20	0,7	L65
	1.6 i [TR]	C 16 SE [OHC]	74/101	08.1996	09.1998	RFC 42 LZ2E (f)	A5	B30	1,0	F54
	1.8 i 16V [TS]	X 18 XE [DOHC]	85/115	09.1998		RFC 42 LZ2E	A5	B30	1,0	F54
BARINA	1.2 i City [SB]	C 12 NZ [OHC]	33/45	04.1994	12.2001	RC 52 LS (e)	A9	B20	0,7	L65
	1.2 i City [SB]	C 12 NZ [OHC]	33/45	04.1994	12.2001	RFC 42 LZ2E (f)	A5	B30	1,0	F54
	1.4 i [MB, ML]	C 14 NZ [OHC]	44/60	01.1985	01.1989	RC 52 LS (e)	A9	B20	0,7	L65
	1.4 i [MB, ML]	C 14 NZ [OHC]	44/60	01.1985	01.1989	RFC 42 LZ2E (f)	A5	B30	1,0	F54
	1.4 i [SB]	C 14 SE [OHC]	60/82	08.1997	12.2001	RC 52 LS (e)	A9	B20	0,7	L65
	1.4 i [SB]	C 14 SE [OHC]	60/82	08.1997	12.2001	RFC 42 LZ2E (f)	A5	B30	1,0	F54
	1.4 i 16V [SD, XC]	Z 14 XE [DOHC] Cat	66/90	01.2001		RFC 42 LZ2E	A5	B30	1,0	F54
	1.4 i Cabrio [SB]	C 14 NZ [OHC]	44/60	04.1994	12.2001	RC 52 LS (e)	A9	B20	0,7	L65
	1.4 i Cabrio [SB]	C 14 NZ [OHC]	44/60	04.1994	12.2001	RFC 42 LZ2E (f)	A5	B30	1,0	F54
	1.6 i [SB]	C 16 XE [DOHC]	80/109	04.1994	03.1995	RFC 42 LZ2E	A5	B30	1,0	F54
CALIBRA	1.6 i 16V [SB]	X 16 XE [DOHC]	78/106	04.1995	09.1998	RFC 42 LZ2E	A5	B30	1,0	F54
	2.0 i [YE]	C 20 NE [OHC]	85/115			RC 52 LS (e)	A9	B20	0,7	L65
	2.0 i [YE]	C 20 NE [OHC]	85/115			RFC 42 LZ2E (f)	A5	B30	1,0	F54
	2.0 i 16V [YE]	C 20 XE [DOHC]	110/150	09.1992		RFC 42 LZ2E	A5	B30	1,0	F54

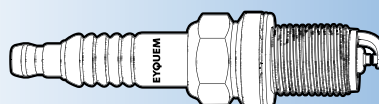

(1) Available until end of stock
 (a) 30 000 km
 (b) 60 000 km
 (c) Grey sticker on ignition coil
 (d) Green sticker on ignition coil

(e) Hex 21 mm
 (f) Hex 16 mm
 (g) Recommended for cold weather



Box 10
Blister 4



F3-D1

HOLDEN

	2.0 i 16V [YE]	C 20 XE [DOHC]	110/150		08.1992	RFC 58 LZ2E	A10	B31	0,9	F54
	2.0 i 16V [YE]	X 20 XEV [DOHC]	100/136			RFC 42 LZ2E	A5	B30	1,0	F54
	2.5 i V6 [YE]	C 25 XE [DOHC]	125/170	08.1995	07.1998	RFC 42 LZ2E	A5	B30	1,0	F54
GEMINI	1.5 [RB]	4XC1	52/71	01.1985	07.1987	RC 62 LS5	A24		1,1	L65-5
	1.6 [T_]	G161Z		01.1982		RC 62 LS	A6	B17	0,8	L65
NOVA	1.6 i 16V [LE, LF]	4A-FE [DOHC] Cat	77/105	08.1989	06.1991	RFC 52 LS5	A26	B24	1,1	F54-5
	1.6 i 16V [LE, LF]	4A-FE [DOHC] Cat	77/105	06.1991	10.1994	RFC 58 LZ5	A101		1,1	F54-5
	1.6 i 16V [LG]	4A-FE [DOHC] Cat	77/105	10.1994	04.1997	RFC 58 LZ5	A101		1,1	F54-5
	1.8 i 16V [LE, LF]	7A-FE [DOHC] Cat	85/115	08.1989	10.1994	RFC 58 LZ5	A101		1,1	F54-5
	1.8 i 16V [LG]	7A-FE [DOHC] Cat	85/115	10.1994	04.1997	RFC 58 LZ5	A101		1,1	F54-5
PIAZZA	2.0 i Turbo [YB]	4ZC1T	110/150	01.1986		RC 52 LS5	A36	B38	1,1	L65-5
VECTRA	2.0 i 16V [JR, JS]	C 20 SEL [DOHC]	100/136	06.1997		RC 52 LS5	A36	B38	1,1	L65-5
	2.5 i V6 24V [JR, JS]	X 25 XE [DOHC]	125/170	06.1997		RFC 42 LZ2E	A5	B30	1,0	F54

HONDA

ACCORD II	1.6 12V Coupé	EZ 1/2	65/88	09.1983	10.1985	RC 62 LS5	A24		1,1	L65-5	
	1.6 Coupé	EL 16	59/80	06.1975	08.1985	RC 62 LS	A6	B17	0,9	L65	
	1.8 12V Coupé	ET 1	72-74/98-100	09.1983	10.1985	RC 62 LS5	A24		1,1	L65-5	
	1.8 i 16V	F18 A	74/101	09.1983	08.1985	RFC 32 LZ5	A117		1,1		
ACCORD III	1.6	A16 A1	65/88	11.1985	12.1989	RC 62 LS5	A24		1,1	L65-5	
	2.0 16V	F20 A2 - A6	66-81/90-110	09.1988		RFC 58 LZ5E	A75		1,1	F54-5	
	2.0 Aerodeck, Hatchback	A20 A2	78/106	11.1985	12.1989	RC 62 LS5	A24		1,1	L65-5	
	2.0 Aerodeck, Hatchback	A20 A1 Cat	75/102	08.1987	12.1989	RC 52 LS5	A36	B38	1,1	L65-5	
	2.0 i 16V	B20 A [DOHC]	101/137	08.1986	12.1989	RFC 58 LS5	A38	B48	1,1	F54-5	
	2.0 i Aerodeck, Hatchback	A20 A3 Cat	85/115	09.1985	12.1989	RC 52 LS5	A36	B38	1,1	L65-5	
	2.0 i Aerodeck, Hatchback	A20 A4	90/122	11.1985	12.1989	RC 62 LS5	A24		1,1	L65-5	
ACCORD IV	1.8 16V	F18 A2	77/105	09.1989		RFC 58 LZ5E	A75		1,1	F54-5	
	2.0 i 16V	F20 A [DOHC] Cat	111/150	09.1989	02.1994	RFC 58 LZ5E	A75		1,1	F54-5	
	2.0 i 16V	F20 A4 [SOHC] Cat	98/133	01.1990		RFC 58 LZ5E	A75		1,1	F54-5	
	2.2 i 16V	F22 A7 - A8 Cat	108/147	01.1990	08.1994	RFC 58 LZ5E	A75		1,1	F54-5	
	2.2 i 16V	F22 A3 - B5 [SOHC] Cat	110/150	01.1990		RFC 58 LZ5E	A75		1,1	F54-5	
	2.0 i 16V	F20 A7 [SOHC] Cat	98/133	01.1992		RFC 58 LZ5E	A75		1,1	F54-5	
ACCORD IV; V	2.2 i 16V	F22 A [SOHC] Cat	110/148	11.1991	09.1997	RFC 32 LZ5	A117		1,1		
	1.8 i 16V	F18 B [SOHC]	74/101	09.1993	09.1997	RFC 32 LZ5	A117		1,1		
ACCORD V	1.8 i 16V LS	F18 A3 Cat	85/115	09.1993		RFC 58 LZ5E	A75		1,1	F54-5	
	2.0 i	F20 B Cat	133/181	09.1993	09.1997	RFC 32 LZ5	A117		1,1		
	2.0 i 16V	F20 Z2 [SOHC] Cat	85/115	03.1993	12.1995	RFC 58 LZ5E	A75		1,1	F54-5	
	2.2 i 16V	F22 B [SOHC] Cat	103/140	09.1993	09.1997	RFC 58 LZ5E	A75		1,1	F54-5	
	2.2 i 16V	H22 A7	156/212	09.1993	09.1997	RFC 58 LZ5E	A75		1,1	F54-5	
	2.3 i 16V	H23 A3 [DOHC] Cat	116/158	03.1993	09.1995	RFC 58 LZ5E	A75		1,1	F54-5	
	ACCORD VI (CK, CG, CH, CF8)	1.6 LS (CG7)	D16B7	79/107	10.1998	12.2002	RFC 58 LZ5E	A75		1,1	F54-5
		1.6 i (CG7)	D16B6	85/116	10.1998	12.2002	RFC 58 LZ5E	A75		1,1	F54-5
		1.8 i (CG8)	F18B2	100/136	10.1998	12.2002	RFC 58 LZ5E	A75		1,1	F54-5
		2.0 i (CG9)	F20B6	108/147	10.1998	01.2001	RFC 58 LZ5E	A75		1,1	F54-5
2.2 Type-R (CH1)		H22A7	156/212	02.1999	12.2002	RFC 58 LZ5E	A75		1,1	F54-5	
ACCORD VI Coupé (CG)	2.3 (CL3)	F23Z5	113/154	01.2001	06.2003	RFC 58 LZ5E	A75		1,1	F54-5	
	2.0 i 16V	F20B5	108/147	02.1998	06.2003	RFC 58 LZ5E	A75		1,1	F54-5	
	3.0 V6 24V (CG2)	J30A1	147/200	02.1998	06.2003	RFC 58 LZ5E	A75		1,1	F54-5	
ACCORD VI Hatchback (CH, CL)	1.8 i (CH6)	F18B2	100/136	12.1999	12.2002	RFC 58 LZ5E	A75		1,1	F54-5	
	2.0 (CH7)	F20B6	108/147	12.1999	12.2002	RFC 58 LZ5E	A75		1,1	F54-5	
	2.3 (CL4)	F23Z5	113/154	11.2000	12.2002	RFC 58 LZ5E	A75		1,1	F54-5	
ACCORD VII	1.6 i	D16B6	85/115	10.1998	02.2003	RFC 58 LZ5E	A75		1,1	F54-5	
	1.8 i S	F18 B2	100/136	01.1999		RFC 58 LZ5E	A75		1,1	F54-5	
	1.9 i	F18A3	85/115	02.1996	10.1998	RFC 58 LZ5E	A75		1,1	F54-5	
	2.0 i 16V	F20 Z1 [DOHC] Cat	96/131	01.1996		RFC 58 LZ5E	A75		1,1	F54-5	
	2.0 i 16V	F20 B5	108/147	03.1998		RFC 58 LZ5E	A75		1,1	F54-5	
	2.0 i ES, LS	F20 B6	108/147	01.1999		RFC 58 LZ5E	A75		1,1	F54-5	
	2.2 i 16V	F22 Z2 VTEC	110/150	09.1995		RFC 58 LZ5E	A75		1,1	F54-5	
	2.3 i 16V	F23 Z5 Cat	112/152	01.2001	02.2003	RFC 58 LZ5E	A75		1,1	F54-5	
	3.0 V6 24V Coupé	J30A1	147/200	02.1998	06.2003	RFC 52 LZ5E	A91		1,1	F54-5	
	ACTY / STREET	0.66 i 12V	E07 A Cat	47/64	03.1990	06.1999	RFC 58 LS5	A38	B48	1,1	F54-5
ACTY TN	0.6 TN 550	EH	22/30	07.1978	05.1988	RC 62 LS	A6	B17	0,9	L65	
	2.0 2000, 2.5 2500	E200 - E250		01.1983		RC 62 LS	A6	B17	0,9	L65	
ASCOT	1.8 i 16V	F18 A	74/101	09.1989	09.1993	RFC 32 LZ5	A117		1,1		
	1.8 i 16V	F18 B [SOHC]	100/136	09.1989	09.1993	RFC 32 LZ5	A117		1,1		

(f) Available until end of stock

(a) 30 000 km

(b) 60 000 km

(c) Grey sticker on ignition coil

(d) Green sticker on ignition coil

(e) Hex 21 mm

(f) Hex 16 mm

(g) Recommended for cold weather



EYQUEM



Box
10

Blister
4



HONDA										
	2.0 i 16V, Inova	F20 A Cat	111/150	04.1992	09.1997	RFC 58 LZE5	A75		1,1	F54-5
BALLADE	1.5 EX, EXi		63-74/86-100	10.1986	12.1989	RC 62 LS5	A24		1,1	L65-5
	1.5 i 12V EX, EXi		63-74/86-100	10.1986	12.1989	RC 62 LS5	A24		1,1	L65-5
BEAT	650 : 0.66 i 12V	E07 A Cat	47/64	05.1991		RFC 58 LS5	A38	B48	1,1	F54-5
CAPA	1.6 i 16V	B16 A Cat	112/152	04.1998		RFC 58 LS5	A38	B48	1,1	F54-5
CITY	1.2	D12 A	56/76	11.1986	08.1987	RC 52 LS5	A36	B38	1,1	L65-5
	1.2	D12 A	56/76	09.1987	03.1994	RFC 52 LS5	A26	B24	1,1	F54-5
	1.3	D13 C	60/82	09.1988	04.1994	RFC 52 LS5	A26	B24	1,1	F54-5
	1.3 i	D13 C	73/99	09.1988	04.1994	RFC 52 LS5	A26	B24	1,1	F54-5
CIVIC	1.2	EB 1, EB 2, EB 3	40-44/54-60	01.1972	12.1980	C 62 LS	A4	B5	0,8	L65
	1.4	WD	57/78	08.1980	08.1984	RC 62 LS	A6	B17	0,8	L65
	1.4 i 16V	D14 V1 Cat	66/90	02.2001		RFC 58 LZE5	A75		1,1	F54-5
	1.5 i DX, LX, VX			10.1991	11.1995	RFC 32 LZ5	A117		1,1	
	1.6 ES			10.1991	11.1995	RFC 32 LZ5	A117		1,1	
	1.6 i 16V	D16 V1 Cat	81/110	02.2001		RFC 58 LZE5	A75		1,1	F54-5
	1.6 Si, VTI			10.1991	11.1995	RFC 32 LZ5	A117		1,1	
CIVIC I; II	1.3 Break	EN	33-51/45-69	09.1979	08.1985	RC 52 LS	A9	B20	0,8	L65
CIVIC II	1.2	ZA 2	40/54	01.1985	10.1987	RC 62 LS5	A24		1,1	L65-5
	1.3	EV 2	51-53-59/69-72-80	10.1983	08.1988	RC 62 LS5	A24		1,1	L65-5
	1.5 4x4	EW 2	63/86	10.1983	10.1987	RC 62 LS5	A24		1,1	L65-5
	1.5 GL	EW 2	61-66/83-90	10.1983	10.1987	RC 62 LS5	A24		1,1	L65-5
	1.5 i GT	EW 3	69-74/94-100	10.1983	10.1987	RC 62 LS5	A24		1,1	L65-5
CIVIC II; III	1.5 i GT	EW 4	66/90	01.1986		RC 62 LS5	A24		1,1	L65-5
CIVIC III	1.2	D12 B1		10.1987	09.1991	RFC 58 LS5	A38	B48	1,1	F54-5
	1.3 i	D13 B	55/75	10.1987	09.1991	RFC 58 LS5	A38	B48	1,1	F54-5
	1.3 i Hatchback	D13 B	55/75	09.1987	09.1991	RFC 58 LS5	A38	B48	1,1	F54-5
	1.4	D14 A [SOHC]	66/90	01.1988	09.1989	RFC 58 LS5	A38	B48	1,1	F54-5
	1.5 i	D15 B	66/90	10.1987	09.1991	RFC 58 LS5	A38	B48	1,1	F54-5
	1.5 i 16V	D15 B [SOHC] Cat	66/90	01.1988	11.1991	RFC 58 LS5	A38	B48	1,1	F54-5
	1.5 i 16V DXi, LSi	D15 B [SOHC] Cat	66/90	10.1988	09.1991	RFC 58 LS5	A38	B48	1,1	F54-5
	1.6 i 16V	D16 A7	96/131	10.1987	09.1991	RFC 58 LS5	A38	B48	1,1	F54-5
	1.6 i 16V	B16 A Cat	110/150	09.1989	10.1991	RFC 58 LS5	A38	B48	1,1	F54-5
	1.6 i 16V 4x4	D16 A6 - Z2 Cat	80-81/109-110	10.1987	09.1991	RFC 62 LS5	A42		1,1	F54-5
	1.6 i 16V 4x4, Realtime	D16 A - Z2	81/110	01.1988		RFC 58 LS5	A38	B48	1,1	F54-5
CIVIC III; IV	1.3 i 16V DX, BREEZE	D13 B [SOHC]	55/75	09.1988	09.1995	RFC 58 LS5	A38	B48	1,1	F54-5
	1.6 i 16V	D16 A6 - A9	81-110/110-150	10.1987	09.1995	RFC 58 LS5	A38	B48	1,1	F54-5
	1.6 i 16V	D16 Z6 VTEC Cat	92/125	10.1987	09.1995	RFC 58 LS5	A38	B48	1,1	F54-5
CIVIC IV	1.3 i 16V	D13 B [SOHC]	55/75	10.1991	09.1995	RFC 58 LS5	A38	B48	1,1	F54-5
	1.5 i	D15 B VTEC-E [SOHC] Cat		09.1991	09.1995	RFC 32 LZ5	A117		1,1	
	1.5 i 16V	D15 Z1 VTEC [SOHC] Cat	66/90	10.1991	09.1995	RFC 58 LZE5	A75		1,1	F54-5
	1.6 i 16V	ZC	92/125	09.1991	09.1995	RFC 62 LS5	A42		1,1	F54-5
	1.6 i 16V	B16 AVTEC [DOHC] Cat	118/160	10.1991		RFC 58 LS5	A38	B48	1,1	F54-5
	1.6 i 16V 4x4	B16 AVTEC [DOHC] Cat	118/160	10.1991		RFC 58 LS5	A38	B48	1,1	F54-5
	1.6 i 16V 4x4	D16 Z6 - Z7 VTEC Cat	88-92/120-125	10.1991		RFC 58 LS5	A38	B48	1,1	F54-5
	1.6 i 16V ESI	D16 Z6 VTEC Cat	92/125	01.1992	12.1995	RFC 58 LS5	A38	B48	1,1	F54-5
	1.6 i 16V VTI	B16 AVTEC [DOHC] Cat	118/160	01.1992		RFC 58 LS5	A38	B48	1,1	F54-5
CIVIC IV; V	1.4 i 16V LS	D14 A2	66/90	09.1994		RFC 58 LS5	A38	B48	1,1	F54-5
	1.5 i 16V LS	D15 Z3 VTEC Cat	66/90	09.1994		RFC 58 LZE5	A75		1,1	F54-5
	1.6 i 16V LS	D16 Y3 [SOHC] Cat	83/113	09.1994		RFC 58 LS5	A38	B48	1,1	F54-5
	1.6 i 16V SR	D16 Y2 VTEC [SOHC] Cat	93/126	09.1994		RFC 58 LS5	A38	B48	1,1	F54-5
CIVIC V	1.4 i	D14 A5	55/75	09.1995		RFC 58 LS5	A38	B48	1,1	F54-5
	1.4 i	D14 Z2 VTEC [SOHC] Cat	66/90	07.1998		RFC 58 LZE5	A75		1,1	F54-5
	1.4 i 16V	D14 A3 - A4 [SOHC] Cat	55-66/75-90	10.1995		RFC 58 LS5	A38	B48	1,1	F54-5
	1.4 i 16V iS	D14 A3 - A4 [SOHC] Cat	55-66/75-90	09.1995		RFC 58 LS5	A38	B48	1,1	F54-5
	1.5 i 16V	D15 Z8 VTEC [SOHC] Cat	84/114	03.1998		RFC 58 LZE5	A75		1,1	F54-5
	1.5 i 16V LS	D15 Z8 VTEC [SOHC] Cat	84/114	01.1997		RFC 58 LZE5	A75		1,1	F54-5
	1.6 i 16V	D16 Y5 VTEC [SOHC] Cat	84/114	10.1995		RFC 58 LZE5	A75		1,1	F54-5
	1.6 i 16V	D16 Y8 VTEC [SOHC] Cat	92/125	11.1995	02.2001	RFC 58 LS5	A38	B48	1,1	F54-5
	1.6 i 16V LS	D16 B2	85/115	09.1996		RFC 58 LZE5	A75		1,1	F54-5
	1.6 i 16V LS, SR	D16 Y7 VTEC [SOHC] Cat	77/105	09.1995	04.2000	RFC 52 LS5	A26	B24	1,1	F54-5
	1.6 i 16V LS, SR	D16 Y6 VTEC [SOHC] Cat	77/105	09.1995		RFC 52 LS5	A26	B24	1,1	F54-5
	1.6 i 16V LS, SR	D16 Y8 VTEC [SOHC] Cat	92/125	09.1995	04.2000	RFC 52 LS5	A26	B24	1,1	F54-5
	1.6 i Hatchback	D16Y5	84/114	11.1995	02.2001	RFC 58 LZK (a)	A11	B29	0,8	F54
	1.8 i 16V VTI	B18 C [DOHC]	124/169	01.1997		RFC 58 LS5	A38	B48	1,1	F54-5
CIVIC VI	1.7 i 16v	D17 A8 - A9 VTEC Cat	88-92/120-125	05.2001		RFC 58 LZE5	A75		1,1	F54-5

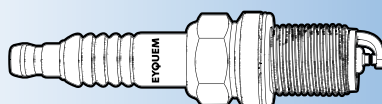

- (1) Available until end of stock
 (a) 30 000 km
 (b) 60 000 km
 (c) Grey sticker on ignition coil
 (d) Green sticker on ignition coil

- (e) Hex 21 mm
 (f) Hex 16 mm
 (g) Recommended for cold weather



Box
10

Blister
4



HONDA

	2.0 i Sport, Hatchback	K20A3	118/160	01.2004		RFC 58 LZE5	A75		1,1	F54-5
CIVIC VI A (EJ, EK)	1.4 i (EJ9)	D14A4	66/90	11.1995	02.2001	RFC 58 LS5	A38	B48	1,1	F54-5
	1.5 i (EK3)	D15Z6	84/114	11.1995	02.2001	RFC 58 LZE5	A75		1,1	F54-5
	1.6 i Vtec	D16Y8-D16Y6	92/125	11.1995	12.1998	RFC 52 LS5	A26	B24	1,1	F54-5
	1.6 i Vtec	D16Y8-D16Y6	92/125	01.1999	02.2001	RFC 58 LS5	A38	B48	1,1	F54-5
	1.6 VTI (EK4)	B16A2	118/160	11.1995	02.2001	RFC 82 LS5	A65		1,1	
CIVIC VI Aerodeck (MB, MC)	1.4 16V	D14A7	55/75	04.1998	02.2001	RFC 58 LZE5	A75		1,1	F54-5
	1.4 16V	D14A8	66/90	04.1998	02.2001	RFC 58 LZE5	A75		1,1	F54-5
	1.5 16V	D15Z8	84/114	04.1998	02.2001	RFC 58 LZE5	A75		1,1	F54-5
	1.6 16V	D16B2	86/116	04.1998	02.2001	RFC 58 LZE5	A75		1,1	F54-5
	1.6 16V	D16W4	92/125	04.1998	02.2001	RFC 58 LZE5	A75		1,1	F54-5
	1.8 16V	B18C4	124/169	04.1998	02.2001	RFC 58 LS5	A38	B48	1,1	F54-5
CIVIC VI Coupé (EJ, EM1)	1.6 i	D16Y7	77/105	03.1996	12.1998	RFC 58 LS5	A38	B48	1,1	F54-5
	1.6 i	D16Y7	77/105	01.1999	03.2000	RFC 58 LZE5	A75		1,1	F54-5
	1.6 i Vtec (EM1)	D16Y8	92/125	03.1996	12.1998	RFC 58 LS5	A38	B48	1,1	F54-5
CIVIC VI Coupé (EJ, EM1)	1.6 i Vtec (EM1)	D16Y8	92/125	01.1999	03.2000	RFC 58 LZE5	A75		1,1	F54-5
CIVIC VI Fastback (MA, MB)	1.4 i (MA8, MB2)	D14A2	55/75	09.1995	02.2001	RFC 58 LS5	A38	B48	1,1	F54-5
	1.4 i (MA8, MB2)	D14A2	66/90	06.1995	02.2001	RFC 58 LS5	A38	B48	1,1	F54-5
	1.4 i (MA8, MB2)	D14Z4/D14A8	66/90	06.1995	02.2001	RFC 58 LZE5	A75		1,1	F54-5
	1.5 Vtec -E (MA9)	D15Z3	66/90	09.1194	01.1997	RFC 58 LZE5	A75		1,1	F54-5
	1.5 16V (MB3)	D15Z8	84/114	01.1997	02.2001	RFC 58 LZE5	A75		1,1	F54-5
	1.6 i (MB1)	D16Y3	83/113	09.1194	01.1997	RFC 58 LS5	A38	B48	1,1	F54-5
	1.6 16V (MB4)	D16B2	85/116	01.1997	02.2001	RFC 58 LZE5	A75		1,1	F54-5
	1.6 i Vtec (MB1)	D16Y2	93/126	09.1194	01.1997	RFC 58 LS5	A38	B48	1,1	F54-5
	1.6 VTI	B16A2	118/160	01.1997	02.2001	RFC 82 LS5	A65		1,1	
	1.8 16V (MB6)	B18C4	124/169	01.1997	02.2001	RFC 58 LS5	A38	B48	1,1	F54-5
CIVIC VI Hatchback (EJ, EK)	1.4 i (EJ9)	D14A3	55/75	11.1995	02.2001	RFC 52 LS5	A26	B24	1,1	F54-5
	1.4 i (EJ9)	D14Z1	55/75	11.1995	02.2001	RFC 58 LZE5	A75		1,1	F54-5
	1.4 i S (EJ9)	D14A4	99/90	11.1995	02.2001	RFC 58 LS5	A38	B48	1,1	F54-5
	1.5 i (EK3)	D15Z6	84/114	11.1995	02.2001	RFC 58 LZE5	A75		1,1	F54-5
	1.6 i (EK1)	D16Y5	84/114	11.1995	02.2001	RFC 58 LZE5	A75		1,1	F54-5
	1.6 VTI (EK4)	B16A2	118/160	11.1995	02.2001	RFC 82 LS5	A65		1,1	
CIVIC VII	1.4	D14Z6	55/75	02.2001	09.2005	RFC 58 LZE5	A75		1,1	F54-5
	1.6	D16V1	81/110	02.2001	09.2005	RFC 58 LZE5	A75		1,1	F54-5
CIVIC VII A (ES, ET)	1.4 (ES4)	D14Z5	66/90	12.2000	09.2005	RFC 58 LZE5	A75		1,1	F54-5
	1.6 i	D16V1	81/100	02.2001	09.2005	RFC 58 LZE5	A75		1,1	F54-5
	1.7 (EU3)	D17A6	85/116	02.2001	09.2005	RFC 58 LZE5	A75		1,1	F54-5
CIVIC VII Coupé (EM2)	1.6 i	D16V1	81/100	02.2001	12.2005	RFC 58 LZE5	A75		1,1	F54-5
	1.7 i	D17A8	88/120	05.2001	12.2005	RFC 58 LZE5	A75		1,1	F54-5
	1.7 i VTEC	D17A9	92/125	05.2001	12.2005	RFC 58 LZE5	A75		1,1	F54-5
CIVIC VII Hatchback (EU, EP, EV)	1.4 i	D14Z6	55/75	02.2001	09.2005	RFC 58 LZE5	A75		1,1	F54-5
	1.4 iS (EP1)	D14Z6	66/90	02.2001	09.2005	RFC 58 LZE5	A75		1,1	F54-5
	1.6 i	D16V1	81/100	02.2001	09.2005	RFC 58 LZE5	A75		1,1	F54-5
CIVIC VIII Hatchback (FN, FK)	1.4	L13A7	61/83	09.2005	10.2008	RFN 58 LZDP5	A187		1,05	
CONCERTO	1.3 i 16V	D13 B [SOHC]	55/75			RFC 58 LS5	A38	B48	1,1	F54-5
	1.4 EX, GL	D14 A1	66-78/90-106	08.1989		RFC 58 LS5	A38	B48	1,1	F54-5
	1.5 i 16V LXi, i S	D15 B [SOHC] Cat	66/90	08.1989	09.1994	RFC 58 LS5	A38	B48	1,1	F54-5
	1.6	D16 Z1	78/106	01.1990		RFC 58 LS5	A38	B48	1,1	F54-5
	1.6 i 16V	D16 A6 Cat	85/115	08.1989	12.1993	RFC 58 LS5	A38	B48	1,1	F54-5
	1.6 i 16V	ZC	92/125	08.1989	10.1992	RFC 62 LS5	A42		1,1	F54-5
	1.6 i 16V	D16 A9	96/131	01.1990		RFC 58 LS5	A38	B48	1,1	F54-5
	1.6 i 16V 4x4, EXi	D16 A8 - Z2 [DOHC]	82-90/112-122	08.1989		RFC 58 LS5	A38	B48	1,1	F54-5
CR-V	2.0 i 16V	B20 B3 [DOHC] Cat	94-97/128-132	10.1995		RFC 32 LZ5	A117		1,1	
	2.0 i 16V	B20 B [DOHC] Cat	94-97/128-132	10.1995		RFC 58 LZE5	A75		1,1	F54-5
	2.0 i 16V	B20 Z1	108/147	03.1999		RFC 58 LZE5	A75		1,1	F54-5
CR-V I (RD)	2.0 i 16V 4WD	B20B	94/128	10.1995	12.2001	RFC 58 LZE5	A75		1,1	F54-5
	2.0 i 16V 4WD	B20Z1	108/147	01.1999	02.2001	RFC 58 LZE5	A75		1,1	F54-5
CR-V II (RD)	2.0 (RD4)	K20A4	110/150	01.2002	09.2006	RFC 58 LZE5	A75		1,1	F54-5
CRX	1.4	D14 A [SOHC]	66/90	10.1989	02.1992	RFC 58 LS5	A38	B48	1,1	F54-5
	1.5 i	EW 3	74-81/100-110	10.1983	12.1985	RC 62 LS5	A24		1,1	L65-5
	1.5 i 16V	D15 B [SOHC] Cat	66/90	10.1987	02.1992	RFC 58 LS5	A38	B48	1,1	F54-5
	1.6 i 16V	D16 A Cat	80/109	10.1987	02.1992	RFC 62 LS5	A42		1,1	F54-5
	1.6 i 16V	D16 A [DOHC] Cat	91/124	10.1987	02.1992	RFC 58 LS5	A38	B48	1,1	F54-5
	1.6 i 16V	D16 A9	96/131	09.1987		RFC 58 LS5	A38	B48	1,1	F54-5

(f) Available until end of stock

(a) 30 000 km

(b) 60 000 km

(c) Grey sticker on ignition coil

(d) Green sticker on ignition coil

(e) Hex 21 mm

(f) Hex 16 mm

(g) Recommended for cold weather



EYQUEM



Box 10
Blister 4



F3-1

HONDA										
	1.6 i 16V	D16 A		10.1995		RFC 58 LS5	A38	B48	1,1	F54-5
	1.6 i 16V Coupé	ZC	92-99/125-135	03.1986	02.1992	RFC 58 LS5	A38	B48	1,1	F54-5
	1.6 i 16V ESI 16V	D16 Z5	91/124	10.1988	02.1992	RFC 58 LS5	A38	B48	1,1	F54-5
	1.6 i 16V ESI 16V	D16 Z6 VTEC Cat	92/125	10.1991		RFC 58 LS5	A38	B48	1,1	F54-5
	1.6 i 16V Targa	B16 A VTEC [DOHC] Cat	110/150	10.1987	02.1992	RFC 58 LS5	A38	B48	1,1	F54-5
	1.6 i 16V Targa	ZC	92/125	03.1992		RFC 58 LZE5	A75		1,1	F54-5
	1.6 i 16V Targa, VTi	B16 A VTEC [DOHC] Cat	118/160	03.1992	09.1995	RFC 58 LS5	A38	B48	1,1	F54-5
DOMANI	1.5 i	D15 B VTEC-E [SOHC] Cat		02.1994	03.1998	RFC 32 LZ5	A117		1,1	
	1.6 i 16V	ZC	88-96/120-131	10.1992	03.1998	RFC 62 LS5	A42		1,1	F54-5
	1.6 i 16V	D16 A Cat	80/109	01.1997		RFC 62 LS5	A42		1,1	F54-5
	1.8 i 16V	B18 B [DOHC]	104/141	11.1992	03.1998	RFC 32 LZ5	A117		1,1	
FR-V (BE)	1.7 (BE1)	D17A2	92/125	08.2004		RFC 58 LZE5	A75		1,1	F54-5
	2.0 (BE3)	K20A9	110/150	02.2005	12.2006	RFC 58 LZE5	A75		1,1	F54-5
HR-V	1.6 i 16V	D16 A Cat	77/105	03.1999		RFC 62 LS5	A42		1,1	F54-5
	1.6 i 16V	D16W5	91/124	10.1999		RFC 58 LZE5	A75		1,1	F54-5
	1.6 i Joy Machine	D16 W1 [SOHC]	77/105	02.1999		RFC 58 LZE5	A75		1,1	F54-5
INSPIRE	3.2 i V6 24V	C32 A [SOHC]	155/211	02.1995	10.1998	RFC 52 LZDP5	A149		1,1	
INTEGRA	1.5 DX, LX	D15 A1	63/86	03.1985	12.1989	RC 62 LS5	A24		1,1	L65-5
	1.6 i 16V	ZC	92/125	10.1991		RFC 62 LS5	A42		1,1	F54-5
	1.6 i 16V EX, SX	D16 A2 - A3 - ZC	88-92/120-125	03.1985	12.1989	RFC 62 LS5	A42		1,1	F54-5
	1.8 i 16V	B18 A [DOHC]	96/131	01.1989	09.1995	RFC 58 LS5	A38	B48	1,1	F54-5
	1.8 i 16V	B18 B [DOHC]	104/141	10.1991	09.1995	RFC 32 LZ5	A117		1,1	
	1.8 i 16V	B18 C VTEC [DOHC]	124/169	05.1993		RFC 58 LS5	A38	B48	1,1	F54-5
INTEGRA Coupe	1.8 Type-R	B18C6	140/190	11.1997	10.2001	RFC 62 LSDP5	A507		1,1	
JAZZ	1.2	ER 1 - ER 2 - ER 3	33-41/45-56	10.1983	10.1987	RC 52 LS5	A36	B38	1,1	L65-5
	55 1.2	ER4	40/54	09.1984	08.1985	RC 62 LS5	A24		1,1	L65-5
JAZZ II	1.2	L12A1	57/78	03.2002	07.2008	RFC 52 LS5	A26	B24	1,1	F54-5
	1.4	L13A1	61/83	03.2002	07.2008	RFC 52 LS5	A26	B24	1,1	F54-5
LEGEND	2.5 i V6 24V	C25 A	110-127/150-173	01.1986	04.1991	RFC 58 LS5	A38	B48	1,1	F54-5
	2.7 i V6 24V	C27 A,A1 Cat	124-132/169-180	09.1987	04.1991	RFC 58 LS5	A38	B48	1,1	F54-5
	3.2 i V6 24V	C32 A [SOHC]	155/211	10.1990	02.1996	RFC 52 LZDP5	A149		1,1	
	3.2i 24V (KA7)	C32A2	151/205	01.1991	02.1996	RFN 58 LZDP5	A187		1,1	
	3.5 i V6 24V	C35 A Cat	151/205	02.1996		RFC 52 LZDP5	A149		1,1	
LEGEND II	3.2 i 24V	C32A2	151/205	01.1991	02.1996	RFC 62 LSDP5	A507		1,1	
LEGEND III	3.5 i 24V	C35A2	151/205	02.1996		RFC 62 LSDP5	A507		1,1	
LIFE	0.66 i 12V	E07 A Cat	47/64	04.1997	10.1998	RFC 58 LS5	A38	B48	1,1	F54-5
	0.66 i 12V	E07 Z [SOHC] Cat	37/50	10.1998		RFC 58 LS5	A38	B48	1,1	F54-5
LOGO	1.3 i	D13 B [SOHC]	48/65	10.1996		RFC 58 LZE5	A75		1,1	F54-5
	1.3 i 16V	D13 B [SOHC]	55/75	11.1998		RFC 58 LS5	A38	B48	1,1	F54-5
NSX	3.0 i V6 24V	C30 A	200/272	06.1990	09.1999	RFC 52 LZDP5	A149		1,1	
NSX Cabriolet	3.0 24V Vtec	C30A3	201/274	03.1995	09.2005	RFC 62 LSDP5	A507		1,1	
	3.0 24V Vtec Automatic	C30A4	188/256	03.1995	09.2005	RFC 62 LSDP5	A507		1,1	
	3.2 24V Vtec	C32B2	206/280	01.1997	09.2005	RFC 62 LSDP5	A507		1,1	
NSX Coupe	3.0	C30A3	188/256	05.1997		RFN 58 LZDP5	A187		1,1	
	3.0	C30A4	201/274	05.1997		RFN 58 LZDP5	A187		1,1	
	3.0 24V Vtec (NA1)	C30A3	201/274	06.1990	09.2005	RFC 62 LSDP5	A507		1,1	
	3.0 24V Vtec Automatik (NA1)	C30A4	188/256	06.1990	09.2005	RFC 62 LSDP5	A507		1,1	
	3.2	C32B2	206/280	05.1997		RFN 58 LZDP5	A187		1,1	
	3.2 24V Vtec (NA2)	C32B2	206/280	01.1997	09.2005	RFC 62 LSDP5	A507		1,1	
ODYSSEY / SHUTTLE	2.2 i 16V 4WD	F22 B [SOHC] Cat	103-107/140-146	10.1994		RFC 32 LZ5	A117		1,1	
	2.3 i 16V	F23 A VTEC Cat	110/150	08.1997		RFC 32 LZ5	A117		1,1	
ORTHIA	1.8 i 16V	B18 B [DOHC]	104/141	03.1996	06.1999	RFC 32 LZ5	A117		1,1	
	2.0 i 16V	B20 B [DOHC] Cat	107/145	03.1996		RFC 58 LZE5	A75		1,1	F54-5
PARTNER	1.3 i 16V	D13 B [SOHC]	67/91	03.1996		RFC 58 LS5	A38	B48	1,1	F54-5
	1.6 i 16V	D16 A Cat	78-89/105-120	03.1996		RFC 62 LS5	A42		1,1	F54-5
PRELUDE	1.6	EL 16	59/80	01.1978	10.1982	RC 52 LS	A9	B20	0,9	L65
	1.8 EX	ET 1	92/125	11.1982	10.1983	RC 62 LS	A6	B17	0,8	L65
	1.8 EX	ET 2/3/4	74-77-92/100-105-125	11.1983	04.1987	RC 62 LS5	A24		1,1	L65-5
	2.0 EX	B20 A	81/110	04.1987	01.1992	RFC 58 LS5	A38	B48	1,1	F54-5
	2.0 i 12V	B20 A3 [SOHC]	80/109	09.1987	12.1992	RFC 58 LS5	A38	B48	1,1	F54-5
	2.0 i 12V	B20 A4 [SOHC]	84/114	04.1987	09.1991	RFC 58 LS5	A38	B48	1,1	F54-5
	2.0 i 16V	B20 A [DOHC]	101/137	09.1984	12.1988	RFC 58 LS5	A38	B48	1,1	F54-5
	2.0 i 16V	B20 A9	102/138	09.1987	12.1992	RFC 58 LS5	A38	B48	1,1	F54-5
	2.0 i 16V	B20 A5	110/150	04.1987	12.1991	RFC 58 LS5	A38	B48	1,1	F54-5
	2.0 i 16V	F20 A4 [SOHC] Cat	98/133	10.1991		RFC 58 LZE5	A75		1,1	F54-5

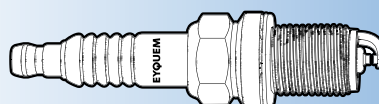

(1) Available until end of stock

- (a) 30 000 km
- (b) 60 000 km
- (c) Grey sticker on ignition coil
- (d) Green sticker on ignition coil

- (e) Hex 21 mm
- (f) Hex 16 mm
- (g) Recommended for cold weather



KW/HP



Box
10
Blister
4



F3→1

HONDA

	2.0 i 16V 4WS	B20 A7	110/150	04.1987	12.1992	RFC 58 LS5	A38	B48	1,1	F54-5
	2.1 i 16V	B21 A [DOHC]	104-107/140-145	10.1990	09.1991	RFC 58 LZE5	A75		1,1	F54-5
	2.2 i 16V	F22 B [SOHC] Cat	100/136	09.1991		RFC 58 LZE5	A75		1,1	F54-5
	2.2 i 16V	F22 A [SOHC] Cat	110/148	02.1992	09.1996	RFC 32 LZ5	A117		1,1	
	2.2 i 16V	F22 B [DOHC] Cat	118/160	11.1996		RFC 58 LZE5	A75		1,1	F54-5
	2.2 16V	H22A5	147/200	10.1996	10.2000	RFN 58 LZDP5	A187		1,1	
	2.2 16V (BB6, BB8)	H22A5	136/185	10.1996	10.2000	RFN 58 LZDP5	A187		1,1	
	2.3 i 16V	H23 A2 [DOHC]	116/158	10.1991		RFC 58 LZE5	A75		1,1	F54-5
QUINT INTEGRA	1.5		56/76	02.1985		RC 62 LS5	A24		1,1	L65-5
	1.6 i	EW	88/120	02.1985		RFC 58 LS5	A38	B48	1,1	F54-5
	1.6 i 16V	B16 A Cat - ZC		02.1985		RFC 58 LS5	A38	B48	1,1	F54-5
QUINTET	1.6	EL	59/80	02.1980	12.1984	RC 52 LS	A9	B20	0,9	L65
S2000	2.0	F20C VTEC	177/241	06.1999		RFC 62 LSDP5	A507		1,1	
SABER	3.2 i V6 24V	C32 A [SOHC]	155/211	02.1995	10.1998	RFC 52 LZDP5	A149		1,1	
SHUTTLE	2.2 i 16V ES	F22 B8 [SOHC] Cat	108-110/147-150	12.1994		RFC 58 LZE5	A75		1,1	F54-5
	2.3 i 16V ES, LS	F23 A7 [SOHC] Cat	110/150	01.1998		RFC 58 LZE5	A75		1,1	F54-5
S-MX	2.0 i 16V	EL 18 - EL 20	59/80	02.1980	12.1984	RC 52 LS	A9	B20	0,9	L65
	2.0 i 16V 4WD	B20 B [DOHC] Cat	96/131	10.1996		RFC 58 LZE5	A75		1,1	F54-5
STEPWAGON	2.0 i 16V 4x4	B20 B [DOHC] Cat	92/125	05.1996		RFC 58 LZE5	A75		1,1	F54-5
STREAM	1.7 i 16v	D17 A2 Cat	92/125	05.2001		RFC 58 LZE5	A75		1,1	F54-5
	2.0 16V	K20A	115/156	05.2001		RFC 58 LZE5	A75		1,1	F54-5
TODAY	0.66 i 12V	E07 A Cat	47/64	03.1990		RFC 58 LS5	A38	B48	1,1	F54-5
	600 : 0.6	EH	23/31	01.1986	12.1992	RC 62 LS	A6	B17	0,9	L65
	660 : 0.66 i 12V	JA 4/5	35-43/48-58	01.1993		RFC 58 LS5	A38	B48	1,1	F54-5
YAQUE, SEYU						RFC 32 LZ5	A117		1,1	
Z	0.66 i 12V	E07 Z [SOHC] Cat	37/50	10.1998		RFC 58 LS5	A38	B48	1,1	F54-5

HUNTER

HUNTER	1.5			01.1966	12.1979	RC 62 LS	A6	B17	0,8	L65
	1.7			01.1966	12.1979	RC 62 LS	A6	B17	0,8	L65

HYUNDAI

ACCENT	1.3	G4BG	44/60	09.1994		RFC 52 LS	A3	B16	0,8	F54
	1.3 i 12V GLS, GS	G4EH Cat	43-62/58-84	07.1994		RFC 52 LS5	A26	B24	1,1	F54-5
	1.5 i 12V GLS	G4EK Cat	63-68/86-92	07.1994		RFC 52 LS5	A26	B24	1,1	F54-5
	1.5 i 16V	G4FK Cat	73/99	08.1995		RFC 52 LS5	A26	B24	1,1	F54-5
	1.5 i 16V		73/99	12.1995	01.2000	RFC 42 LS5	A83		1,1	F54-5
ACCENT II (LC)	1.3	G4EA	55/75	01.2000	11.2005	RFC 52 LS5	A26	B24	1,1	F54-5
	1.3	G4EA	61/83	01.2000	11.2005	RFC 52 LS5	A26	B24	1,1	F54-5
	1.3	G4EH	62/84	08.2002	11.2005	RFC 52 LS5	A26	B24	1,1	F54-5
	1.3	G4EA	63/86	01.2000	11.2005	RFC 52 LS5	A26	B24	1,1	F54-5
	1.5	G4EB	66/90	01.2000	11.2005	RFC 52 LS5	A26	B24	1,1	F54-5
	1.5	G4EC-G	75/102	09.2000	11.2005	RFC 52 LS5	A26	B24	1,1	F54-5
	1.6	G4ED-G	77/105	12.2002	11.2005	RFC 52 LS5	A26	B24	1,1	F54-5
ACCENT II A (LC)	1.3	G4EA	55/75	01.2000	11.2005	RFC 52 LS5	A26	B24	1,1	F54-5
	1.3	G4EA	63/86	01.2000	11.2005	RFC 52 LS5	A26	B24	1,1	F54-5
	1.5	G4EB	66/90	01.2000	11.2005	RFC 52 LS5	A26	B24	1,1	F54-5
	1.6	G4ED-G	77/105	12.2002	11.2005	RFC 52 LS5	A26	B24	1,1	F54-5
ACCENT III (MC)	1.4 GL	G4EE	71/97	11.2005	11.2010	RFC 52 LS5	A26	B24	1,1	F54-5
	1.6 GLS	G4ED	82/112	11.2005	11.2010	RFC 58 LS5	A38	B48	1,1	F54-5
ACCENT III A (MC)	1.4 GL	G4EE	71/97	11.2005	11.2010	RFC 52 LS5	A26	B24	1,1	F54-5
	1.6 GLS	G4ED	82/112	11.2005	11.2010	RFC 52 LS5	A26	B24	1,1	F54-5
ACCENT IV A (RB) NEW	1.6	G4FC	91/123	11.2010		RZC 62 HSET	A526		0,85	
ATOS (MX)	1.0 i	G4HC	40/54	02.1998	12.2000	RFC 52 LS5	A26	B24	1,1	F54-5
	1.0 i 12V	G4HC	40-43/54-58	03.2001	07.2003	RFC 52 LS5	A26	B24	1,1	F54-5
	1.1	G4HD	43/58	06.2003	05.2005	RFC 52 LS5	A26	B24	1,1	F54-5
	1.1	G4HG	46/63	01.1997	12.2008	RFC 52 LS5	A26	B24	1,1	F54-5
ATOS PRIME (MX)	1.0 i	G4HC	40/54	08.1999		RFC 52 LS5	A26	B24	1,1	F54-5
	1.0 i	G4HC-E	43/58	03.2001		RFC 52 LS5	A26	B24	1,1	F54-5
	1.1	G4HD	43/58	06.2003		RFC 52 LS5	A26	B24	1,1	F54-5
	1.1	G4HG	46/63	09.2005		RFC 52 LS5	A26	B24	1,1	F54-5
COUPE (RD)	1.6 16V	G4GR	84/114	03.1996	04.2002	RFC 52 LS5	A26	B24	1,1	F54-5
	1.6 16V	G4GR	85/116	03.1998	04.2002	RFC 42 LS5	A83		1,1	F54-5
	2.0 16V	G4DF	99/135	03.2001	04.2002	RFC 52 LS5	A26	B24	1,1	F54-5
	2.0 16V	G4DF	101/137	08.1999	01.2002	RFC 42 LS5	A83		1,1	F54-5

(1) Available until end of stock

(a) 30 000 km

(b) 60 000 km

(c) Grey sticker on ignition coil

(d) Green sticker on ignition coil

(e) Hex 21 mm

(f) Hex 16 mm

(g) Recommended for cold weather



EYQUEM



Box
10

Blister
4



F3

HYUNDAI

	2.0 16V	G4GF (no catalytic convertor)	102/139	08.1996	04.2002	RFC 52 LS	A3	B16	0,8	F54
	2.0 16V	G4GF (with catalytic convertor)	102/139	08.1996	04.2002	RFC 42 LS5	A83		1,1	F54-5
COUPE (GK)	1.6 16V	G4ED-G	77/105	03.2002	08.2009	RFC 52 LS5	A26	B24	1,1	F54-5
	1.6 16V	G4ED-G	79/109	03.2002	08.2009	RFC 52 LS5	A26	B24	1,1	F54-5
	1.6 16V	G4GC-G	100/136	10.2001	08.2009	RFC 42 LS5	A83		1,1	F54-5
	2.0	G4GC-G	102/139	03.2002	08.2009	RFC 42 LS5	A83		1,1	F54-5
	2.0 GLS	G4GC-G	105/143	02.2003	08.2009	RFC 52 LS5	A26	B24	1,1	F54-5
	2.7 V6	G6BA-G	121/165	01.2001	08.2009	FN 42 LZDPR5	A195		1,05	
	2.7 V6	G6BA-G	123/167	03.2002	08.2009	RFN 58 LZDP5	A187		1,1	
	2.7 V6 LPG	G6BA-G	123/167	03.2002	08.2009	RFN 62 LZDP5	A185		1,0	
COUPE FX / TIBURON	1.6 i 16V	G4GR	84/114	05.1996		RFC 52 LS5	A26	B24	1,1	F54-5
	1.8 i 16V	Beta [DOHC]	97/132	03.1996		RFC 52 LS5	A26	B24	1,1	F54-5
	2.0 i 16V	G4GF	102/139	03.1996		RFC 52 LS5	A26	B24	1,1	F54-5
ELANTRA (XD)	1.6	G4ED-G	77/105	05.2003	07.2006	RFC 42 LS5	A83		1,1	F54-5
	1.6	G4ED-G	79/107	06.2000	07.2006	RFC 42 LS5	A83		1,1	F54-5
	1.8	G4BB-G4GB	97/132	06.2000	07.2006	RFC 42 LS5	A83		1,1	F54-5
	2.0	G4GC-G	102/139	06.2000	07.2006	RFC 42 LS5	A83		1,1	F54-5
	2.0	G4GC	104/141	06.2000	07.2006	RFC 42 LS5	A83		1,1	F54-5
	2.0	G4GC	105/143	10.2003	07.2006	RFC 42 LS5	A83		1,1	F54-5
ELANTRA A (XD)	1.6	G4GR	66/90	06.2000	07.2006	RFC 42 LS5	A83		1,1	F54-5
	1.6	G4ED-G	77/105	05.2003	07.2006	RFC 42 LS5	A83		1,1	F54-5
	1.6	G4ED-G	79/107	06.2000	07.2006	RFC 42 LS5	A83		1,1	F54-5
	1.8	G4BB-G4GB	97/132	06.2000	07.2006	RFC 42 LS5	A83		1,1	F54-5
	2.0	G4GC-G	102/139	06.2000	07.2006	RFC 42 LS5	A83		1,1	F54-5
	2.0	G4GC	104/141	06.2000	07.2006	RFC 42 LS5	A83		1,1	F54-5
	2.0	G4GC	105/143	10.2003	07.2006	RFC 42 LS5	A83		1,1	F54-5
ELANTRA A (MD, UD)	NEW 1.6	G4FG	97/132	06.2011	12.2015	RZC 62 HSET	A526		0,85	
EXCEL	1.3	G4DG	49/67	09.1989	10.1994	RC 62 LS5	A24		1,1	L65-5
	1.3	4G13 Cat	53/72	04.1989	10.1994	RC 62 LS5	A24		1,1	L65-5
	1.3 i 12V	G4EH Cat	44-55/60-75	07.1994		RFC 52 LS5	A26	B24	1,1	F54-5
	1.5	G15B	62/84	04.1989	10.1994	RC 62 LS5	A24		1,1	L65-5
	1.5 i	G4DJ - G15B	53-59/72-80	04.1989	10.1994	RC 62 LS5	A24		1,1	L65-5
	1.5 i 12V	G4EK Cat	62-65-68/84-88-92	07.1994		RFC 52 LS5	A26	B24	1,1	F54-5
	1.5 i 16V	G4FK Cat	73/99	11.1995		RFC 52 LS5	A26	B24	1,1	F54-5
EXCEL (PONY)	1.3	G4DG	49/67	01.1985	09.1989	RC 62 LS5	A24		1,1	L65-5
	1.3	G13B	50-55/68-75	01.1985	03.1989	RC 62 LS5	A24		1,1	L65-5
	1.3	4G13 Cat	45/61	04.1986	03.1989	RC 52 LS5	A36	B38	1,1	L65-5
	1.5	G15B	41-53-62/56-72-84	01.1985	03.1989	RC 62 LS	A6	B17	1,0	L65
GALLOPER I	3.0 V6	6G72	104/141	08.1991	07.1998	RFC 42 LS5	A83		1,1	F54-5
GALLOPER II (JK-01)	3.0 V6	G6AT	104/141	08.1998	08.2001	RC 52 LS5	A36	B38	1,1	L65-5
GETZ (TB)	1.1	G4HD	46/63	09.2002	09.2005	RFC 42 LS5	A83		1,1	F54-5
	1.1	G4HD-G4HG	49/67	09.2005	06.2009	RFC 42 LS5	A83		1,1	F54-5
	1.3	G4E-A	60/82	09.2002		RFC 42 LS5	A83		1,1	F54-5
	1.3 i	G4E-A	60/82	07.2003	03.2004	RFC 52 LS5	A26	B24	1,1	F54-5
	1.3	G4E-A	63/85	09.2003	09.2005	RFC 42 LS5	A83		1,1	F54-5
	1.4 i	G4EE	71/97	08.2005	12.2010	RFC 42 LS5	A83		1,1	F54-5
	1.6	G4ED-G	77/105	09.2002	09.2005	RFC 42 LS5	A83		1,1	F54-5
	1.6	G4ED-G	78/106	06.2005	12.2006	RFC 42 LS5	A83		1,1	F54-5
GRANDEUR	2.0 i	4G63 [SOHC]	88/120	07.1986	08.1992	RC 62 LS5	A24		1,1	L65-5
	2.4 i	4G64 [SOHC]	95/129	07.1987	03.1993	RC 52 LS5	A36	B38	1,1	L65-5
	3.0 V6	6G 72	118-120/160-163	09.1989	10.1994	RC 52 LS5	A36	B38	1,1	L65-5
H-1 Camionnette	2.4	G4CS	82/112	03.200	04.2004	RC 62 LS5	A24		1,1	L65-5
H100 Bus (P1)	2.4	G4CS	84/114	01.1997	03.2000	RC 62 LS5	A24		1,1	L65-5
	2.4 i	G4CS Cat	90/122	07.1993	03.2000	RC 62 LS5	A24		1,1	L65-5
i10 (PA)	NEW 1.0	G3LA	51/69	01.2011	09.2013	RZC 58 HST	A533		0,9	
	1.1	G4HG	48/65	01.2008	12.2013	RFC 42 LS5	A83		1,1	F54-5
	1.1	G4HG	49/65	01.2008	12.2013	RFC 42 LS5	A83		1,1	F54-5
	1.1	G4HG	51/69	04.2011	09.2013	RFC 42 LS5	A83		1,1	F54-5
	NEW 1.2	G4LA	57/78	11.2008	12.2011	RZC 58 HST	A533		0,9	
	NEW 1.2	G4LA	63/86	04.2011	12.2013	RZC 58 HST	A533		0,9	
i10 (BA, IA)	NEW 1.0	G3LA	49/67	08.2013		RZC 58 HST	A533		0,9	
i20 (GB)	NEW 1.2	G4LA	62/84	11.2014		RZC 58 HST	A533		0,9	
i20 (PB, PBT)	NEW 1.2	G4LA	57/78	09.2008	12.2012	RZC 58 HST	A533		0,9	
	NEW 1.2	G4LA	63/86	03.2012	12.2015	RZC 58 HST	A533		0,9	

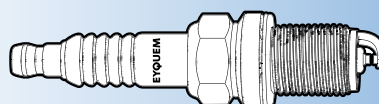

(1) Available until end of stock

- (a) 30 000 km
- (b) 60 000 km
- (c) Grey sticker on ignition coil
- (d) Green sticker on ignition coil

- (e) Hex 21 mm
- (f) Hex 16 mm
- (g) Recommended for cold weather



kW/HP



Box
10

Blister
4



F3-D1

HYUNDAI

	NEW	1.4	G4FA	74/101	09.2008	12.2015	RZC 62 HSET	A526	0,85	
		1.6	G4FC	93/126	09.2008	12.2008	RFC 58 LZE5	A75	1,1	F54-5
	NEW	1.6	G4FC	93/126	01.2009	12.2012	RZC 62 HSET	A526	0,85	
ix20 (JC)	NEW	1.4	G4FA	66/90	11.2010		RZC 62 HSET	A526	0,85	
	NEW	1.6	G4FC	92/125	11.2010		RZC 62 HSET	A526	0,85	
i30 (FD)		1.4	G4FA	77/105	10.2007	12.2008	RFC 58 LZE5	A75	1,1	
	NEW	1.4	G4FA	77/105	01.2009	11.2011	RZC 62 HSET	A526	0,85	
	NEW	1.4	G4FA	80/109	10.2007	12.2008	RFC 58 LZE5	A75	1,1	
	NEW	1.4	G4FA	80/109	01.2009	11.2011	RZC 62 HSET	A526	0,85	
	NEW	1.4	G4FA	73/99	12.2011		RZC 62 HSET	A526	0,85	
		1.6	G4FC	85/115	10.2007	12.2008	RFC 58 LZE5	A75	1,1	
	NEW	1.6	G4FC	85/115	01.2009	11.2011	RZC 62 HSET	A526	0,85	
	NEW	1.6	G4FC	88/120	01.2012		RZC 62 HSET	A526	0,85	
		1.6	G4FC	90/122	10.2007	12.2008	RFC 58 LZE5	A75	1,1	F54-5
	NEW	1.6	G4FC	90/122	01.2009	11.2011	RZC 62 HSET	A526	0,85	
		1.6	G4FC	93/126	02.2008	03.2009	RFC 58 LZE5	A75	1,1	F54-5
	NEW	1.6	G4FC	93/126	04.2009	11.2011	RZC 62 HSET	A526	0,85	
		2.0	G4GC	105/143	10.2007	11.2011	RFC 42 LS5	A83	1,1	F54-5
i30 Break (FD)	NEW	1.4	G4FA	73/99	06.2012		RZC 62 HSET	A526	0,85	
		1.4	G4FA	77/105	10.2007	12.2008	RFC 58 LZE5	A75	1,1	F54-5
	NEW	1.4	G4FA	77/105	01.2009	06.2012	RZC 62 HSET	A526	0,85	
	NEW	1.4	G4FA	80/109	11.2009	06.2012	RZC 62 HSET	A526	0,85	
		1.6	G4FC	85/116	02.2008	03.2009	RFC 58 LZE5	A75	1,1	F54-5
	NEW	1.6	G4FC	85/116	04.2009	06.2012	RZC 62 HSET	A526	0,85	
	NEW	1.6	G4FC	90/122	02.2008	03.2009	RFC 58 LZE5	A75	1,1	F54-5
	NEW	1.6	G4FC	90/122	04.2009	06.2012	RZC 62 HSET	A526	0,85	
	NEW	1.6	G4FC	93/126	02.2008	12.2008	RFC 58 LZE5	A75	1,1	F54-5
	NEW	1.6	G4FC	93/126	01.2009	06.2012	RZC 62 HSET	A526	0,85	
		2.0	G4GC-G	105/143	10.2007	11.2011	RFC 42 LS5	A83	1,1	F54-5
i30 (GD)	NEW	1.4	G4FA	73/99	12.2011	12.2015	RZC 62 HSET	A526	0,85	
	NEW	1.6	G4FG	95/129	12.2011	12.2015	RZC 62 HSET	A526	0,85	
i30 Break (GD)	NEW	1.4	G4FA	73/99	06.2012	12.2015	RZC 62 HSET	A526	0,85	
	NEW	1.6	G4FG	88/120	06.2012		RZC 62 HSET	A526	0,85	
	NEW	1.6	G4FG	95/129	06.2012	12.2015	RZC 62 HSET	A526	0,85	
i30 Coupe	NEW	1.4	G4FA	73/99	05.2013		RZC 62 HSET	A526	0,85	
ix35 (LM, EL, ELH)	NEW	2.0	G4KD	120/163	01.2010		RFN 52 HZ5	A545	1,05	
	NEW	2.0 4WD	G4KD	120/163	01.2010		RFN 52 HZ5	A545	1,05	
	NEW	2.4 DCVWT-I 4WD	G4KE	128/174	07.2010	12.2013	RFN 52 HZ5	A545	1,05	
LANTRA (J-1)		1.5 ie	G15B- G4DJ	63/86	10.1990	04.1995	RC 62 LS5	A24	1,1	L65-5
		1.6 ie 16V	G4CR	78-84/106-114	10.1990	04.1995	RC 62 LS5	A24	1,1	L65-5
		1.8 ie 16V	G4CN	93/127	06.1992	04.1995	RC 62 LS5	A24	1,1	L65-5
LANTRA II (J-2)		1.5 12V	G4EK	65/88	12.1996	09.2000	RFC 52 LS5	A26	B24	1,1 F54-5
		1.6 i	G4GR	66/90	11.1995	09.2000	RFC 42 LS5	A83	1,1	F54-5
		1.6 16V	G4GR	84/114	11.1995	09.2000	RFC 42 LS5	A83	1,1	F54-5
		1.8 16V	G4GM	94/128	11.1995	09.2000	RFC 42 LS5	A83	1,1	F54-5
		2.0 16V	G4GF	102/139	08.1996	09.2000	RFC 42 LS5	A83	1,1	F54-5
LANTRA II Break (J-2)		1.5 12V	G4EK	65/88	04.1997	10.2000	RFC 52 LS5	A26	B24	1,1 F54-5
		1.6 i	G4GR	66/90	02.1996	10.2000	RFC 42 LS5	A83	1,1	F54-5
		1.6 16V	G4GR	84/114	02.1996	10.2000	RFC 42 LS5	A83	1,1	F54-5
		1.8 16V	G4GM	94/128	02.1996	10.2000	RFC 42 LS5	A83	1,1	F54-5
		2.0 16V	G4GF	102/139	12.1996	10.2000	RFC 42 LS5	A83	1,1	F54-5
MATRIX (FC)		1.6	G4ED-L	66/90	01.2002	12.2005	RFC 42 LS5	A83	1,1	F54-5
		1.6	G4ED-G	76/103	06.2001	08.2010	RFC 42 LS5	A83	1,1	F54-5
		1.8	G4GB-G	90/122	06.2001	08.2010	RFC 42 LS5	A83	1,1	F54-5
PONY		1.2	J12G	40/54	06.1974	12.1982	RC 52 LS	A9	B20	0,8 L65
		1.2	Saturn	41-59/56-80	03.1974	09.1985	RC 52 LS	A9	B20	0,8 L65
		1.3	4G13 Cat	45/61	04.1986	03.1989	RC 52 LS5	A36	B38	1,1 L65-5
		1.3 GS, i	G4DG	43-45-49/58-61-67	04.1989	10.1994	RC 62 LS5	A24	1,1	L65-5
		1.3 i GS, i	G13B	50/68	10.1985	03.1989	RC 62 LS5	A24	1,1	L65-5
		1.3 LS, GLS	G4-M				RC 62 LS	A6	B17	0,8 L65
		1.4	4G33	50/68	09.1977	12.1985	RC 52 LS	A9	B20	0,8 L65
		1.4	Saturn	50-68/68-92	03.1977	09.1985	RC 52 LS	A9	B20	0,8 L65
		1.4	4G12	59/80	05.1982	10.1985	C 52 LS	A1	B1	0,8 L65
		1.5, GLS	G15B	53-62/72-84	10.1985	03.1989	RC 62 LS5	A24	1,1	L65-5

- (1) Available until end of stock
- (a) 30 000 km
- (b) 60 000 km
- (c) Grey sticker on ignition coil
- (d) Green sticker on ignition coil

- (e) Hex 21 mm
- (f) Hex 16 mm
- (g) Recommended for cold weather



EYQUEM



Box
10

Blister
4



F3 → 1

HYUNDAI

	1.5 i GLS	G4DJ - G15B	53-63/72-86	04.1989	10.1994	RC 62 LS5	A24		1,1	L65-5
	1.5 i GLSi	G4DJ-S	53-62/72-84	04.1989	10.1994	RC 62 LS5	A24		1,1	L65-5
	1.6			01.1974	12.1985	C 52 LS	A1	B1	0,8	L65
PONY A (X-1)	1.3	G13B	50/68	10.1985	09.1989	RC 62 LS5	A24		1,1	L65-5
	1.5	G15B-G4DJ	53/72	10.1985	09.1989	RC 62 LS5	A24		1,1	L65-5
PONY A (X-3)	1.3 i 12V	G4EH	44/60	10.1994	01.2000	RFC 52 LS5	A26	B24	1,1	F54-5
	1.3 i 12V	G4EH	55/75	10.1994	01.2000	RFC 52 LS5	A26	B24	1,1	F54-5
	1.3 i 12V	G4EH Cat	62/84	10.1994	01.2000	RFC 52 LS5	A26	B24	1,1	F54-5
	1.5 i 12V	G4EK	65/88	10.1994	01.2000	RFC 52 LS5	A26	B24	1,1	F54-5
	1.5 i 16V	G4ER	73/99	12.1995	01.2000	RFC 52 LS5	A26	B24	1,1	F54-5
PONY (X-2)	1.3	G4DG	43/58	10.1989	01.1995	RC 62 LS5	A24		1,1	L65-5
	1.3	G4DG	49/67	10.1989	01.1995	RC 62 LS5	A24		1,1	L65-5
	1.5	G15B-G4DJ	53/72	10.1989	01.1995	RC 62 LS5	A24		1,1	L65-5
	1.5 i	G15B-G4DJ	61/83	10.1989	01.1995	RC 62 LS5	A24		1,1	L65-5
	1.5 i	G15B-G4DJ	62/84	10.1989	01.1995	RC 62 LS5	A24		1,1	L65-5
PONY / EXCEL A (X-2)	1.3	G4DG	43/58	12.1992	07.1994	RC 62 LS5	A24		1,1	L65-5
	1.3	G4DG	51/69	09.1989	08.1994	RC 62 LS5	A24		1,1	L65-5
	1.5	G15B-G4DJ	53/72	01.1990	01.1995	RC 62 LS5	A24		1,1	L65-5
	1.5 i	G15B-G4DJ	61/83	01.1990	01.1995	RC 62 LS5	A24		1,1	L65-5
	1.5 i	G15B-G4DJ	62/84	01.1990	01.1995	RC 62 LS5	A24		1,1	L65-5
PONY I (X-3)	1.3 i 12V	G4EH	44/60	10.1994	01.2000	RFC 52 LS5	A26	B24	1,1	F54-5
	1.3 i 12V	G4EH	55/75	10.1994	01.2000	RFC 52 LS5	A26	B24	1,1	F54-5
	1.3 i 12V	G4EH Cat	62/84	10.1994	01.2000	RFC 52 LS5	A26	B24	1,1	F54-5
	1.5 i 12V	G4EK	65/88	10.1994	01.2000	RFC 52 LS5	A26	B24	1,1	F54-5
	1.5 i 16V	G4ER	73/99	12.1995	01.2000	RFC 52 LS5	A26	B24	1,1	F54-5
	1.5 16V	G4FK	76/104	11.1995	07.1999	RFC 42 LS5	A83		1,1	F54-5
SANTAMO	2.0 16V	G4JP	102/139	05.1999	12.2002	RC 62 LS5	A24		1,1	L65-5
	2.0 16V 4x4	G4CP-D	102/139	05.1999	12.2002	RC 62 LS5	A24		1,1	L65-5
SATELLITE	2.4 i, 4WD	G4CS	82/112	06.1997	04.2004	RC 62 LS5	A24		1,1	L65-5
	2.4 i 4WD	G4JS	99/135	06.2001	04.2004	RC 62 LS5	A24		1,1	L65-5
	2.4 i	G4CS	82-90/112-122	07.1994		RC 62 LS	A6	B17	0,8	L65
	2.4 i	G4CS Cat	82-90/112-122	07.1994		RC 62 LS5	A24		1,1	L65-5
SANTA FÉ I (SM)	2.0	G4BP	99/135	08.2001	03.2006	RC 62 LS5	A24		1,1	L65-5
	2.4 16V, 4x4	G4JS-G	100/136	02.2001	12.2005	L65-5			1,1	L65-5
	2.4 16V, 4x4	G4JS-G	107/146	02.2001	12.2005	L65-5			1,1	L65-5
	2.7 V6 4x4	G6BA-G	127/173	02.2001	03.2006	RFN 58 LZDP5	A187		1,1	
SANTA FÉ II (CM) NEW	2.4	G4KE	128/174	11.2010	12.2012	RFN 52 HZ5	A545		1,05	
NEW	2.4 4x4	G4KE	128/174	07.2010	12.2012	RFN 52 HZ5	A545		1,05	
S COUPE (SLC)	1.5 i	G15B	62/84	02.1990	08.1994	RC 62 LS5	A24		1,1	L65-5
	1.5 i	G15B	71/97	02.1990		RC 62 LS5	A24		1,1	L65-5
	1.5 i	G4DJ	53-62/72-84	02.1990	08.1994	RC 62 LS5	A24		1,1	L65-5
	1.5 i	G4EK	65/88	04.1992	05.1996	RFC 42 LS5	A83		1,1	F54-5
	1.5 i 12V,	G4EK Cat	65-68/88-92	01.1992	04.1995	RFC 52 LS5	A26	B24	1,1	F54-5
	1.5 i	HMC Alpha	71/97	02.1990	04.1992	RFC 62 LS	A48		0,8	F86
	1.5 i Turbo GT Turbo,	G4EK-TC	85/115	04.1991	04.1996	RFC 58 LS	A18		0,8	F54
SONATA II (Y-2)	1.8 i	4G62 Cat	70/95	06.1988	10.1993	RC 62 LS5	A24		1,1	L65-5
	1.8 i	G62B	70-73/95-99	01.1989		RC 62 LS5	A24		1,1	L65-5
	2.0 i	4G63 [SOHC]	72-74/98-100	06.1988	10.1993	RC 62 LS5	A24		1,1	L65-5
	2.0 i	G4CP-U	80/109	01.1991	10.1993	RC 62 LS	A6	B17	0,8	L65
	2.0 i 16V	G4CP-D	96/130	01.1991	10.1993	RC 62 LS5	A24		1,1	L65-5
	2.4 i	4G64 [SOHC]	80-82-86/109-112-117	10.1988	10.1993	RC 52 LS5	A36	B38	1,1	L65-5
	2.4 i	G4CS	83/113	09.1988	08.1991	RC 62 LS5	A24		1,1	L65-5
	3.0 i V6	6G 72 [SOHC] Cat - G6AT	107/145	09.1989	08.1998	RC 32 LS5	A110		1,1	
SONATA III (Y-3)	1.8 GLS	G4DM	63/86	07.1996	05.1998	RC 62 LS5	A24		1,1	L65-5
	1.8 i	G4CM	72-80/98-109	07.1993	08.1998	RC 62 LS5	A24		1,1	L65-5
	2.0 i	G4EP	70/95	08.1996	06.1998	RC 62 LS5	A24		1,1	L65-5
	2.0 i 16V	G4CP Cat	77-85/105-115	07.1993	08.1996	RC 62 LS5	A24		1,1	L65-5
	2.0 i 16V GLS	G4CP Cat	92-107/125-146	05.1996	06.1998	RC 62 LS5	A24		1,1	L65-5
	2.0 i 16V	G4CP-D	102/139	07.1993	06.1996	RC 62 LS5	A24		1,1	L65-5
	3.0 i V6	G6AT	107/145	05.1993	06.1998	RC 52 LS5	A36	B38	1,1	L65-5
SONATA IV (EF)	2.0 i 16V	G4JP-EG	96/131	10.2001	11.2004	RC 62 LS5	A24		1,1	L65-5
	2.0 i 16V	G4JP-G	100/136	05.1998	10.2001	RC 62 LS5	A24		1,1	L65-5
	2.4 16V	G4BS	105/143	03.1998	10.2001	RC 52 LS5	A36	B38	1,1	L65-5
	2.5 V6 24V	G6BV-G	118/160	06.1998	10.2001	RFN 58 LZDP5	A187		1,1	
	2.7 V6	G6BA-G	127/173	10.2001	11.2004	RFN 58 LZDP5	A187		1,1	

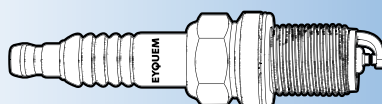

(1) Available until end of stock

- (a) 30 000 km
- (b) 60 000 km
- (c) Grey sticker on ignition coil
- (d) Green sticker on ignition coil

- (e) Hex 21 mm
- (f) Hex 16 mm
- (g) Recommended for cold weather



Box
10

Blister
4



F3→1

HYUNDAI

SONATA V (NF)	2.0 VVTi GLS	G4KA	106/144	12.2005	12.2007	RFC 42 LS5	A83	1,1	F54-5
	NEW 2.0 VVTi	G4KD	121/165	01.2008	12.2010	RFN 52 HZ5	A545	1,05	
	2.4	G4KC	119/162	01.2005	12.2010	RFC 52 LS5	A26	B24	F54-5
	3.3	G6DB	171/233	06.2005	12.2008	RFN 58 LZDP5	A187	1,1	
	3.3	G6DB	173/235	06.2005	12.2010	RFN 58 LZDP5	A187	1,1	
	3.3	G6DB	184/250	06.2005	12.2010	RFN 58 LZDP5	A187	1,1	
SONICA	2.0 i 16V	G4CP	102/139	07.1993	06.1996	RC 62 LS	A6	B17	L65
STAREX	2.4 i 4WD	G4CS	82-86/112-117	10.1997		RC 62 LS	A6	B17	L65
	2.4, 4WD		82/112	06.1997		RC 62 LS5	A24	1,1	L65-5
STELLAR	1.4	Saturn	50/68	09.1983	12.1988	RC 52 LS	A9	B20	L65
	1.6	G32B	55/75	09.1983	12.1989	RC 52 LS	A9	B20	L65
	1.6	4G32	74/101	09.1983	12.1989	RC 62 LS5	A24	1,1	L65-5
	1.8 i Prima	4G62 Cat	70/95	10.1985		RC 62 LS5	A24	1,1	L65-5
	2.0 Prima	4G63 - G63B [SOHC]	67-68/91-92	09.1983	12.1988	RC 62 LS	A6	B17	L65
TERRACAN (HP)	3.5 i V6 4WD	G6CU	143/194	12.2001	10.2006	RFN 58 LZDP5	A187	1,1	
	3.5 i V6 4WD	G6CU	147/200	12.2001		RFN 58 LZDP5	A187	1,1	
TIBURON Coupé	2.0 CVT	G4GC	105/143	10.2006	12.2008	RFC 42 LS5	A83	1,1	F54-5
TRAJET (FO)	2.0	G4GC-G	103/140	01.2004	07.2008	RFC 42 LS5	A83	1,1	F54-5
	2.0	G4JP-G	100/136	03.2000	07.2008	RC 62 LS5	A24	1,1	L65-5
	2.7 V6	G6BA-G	127/173	09.2000	07.2008	RFN 58 LZDP5	A187	1,1	
TUCSON (JM)	2.0	G4GC	104/141	08.2004	03.2010	RFC 42 LS5	A83	1,1	F54-5
	2.7	G6BA-G	129/175	08.2004	03.2010	RFN 58 LZDP5	A187	1,1	
VELOSTER (FS) NEW	1.6 MPI	G4FG	97/132	04.2011		RZC 62 HSET	A526	0,85	
XG (XG)	250	G6BV	120/163	12.1998	12.2005	RFN 58 LZDP5	A187	1,1	
	30/300	G6CT-G	138/188	12.1998	12.2005	RFN 58 LZDP5	A187	1,1	
	350	G6CU	145/197	10.2002	12.2005	RFN 58 LZDP5	A187	1,1	

INFINITI

FX	35	VQ35DE	206/280	01.2003		RFN 42 HZDP5	A184	0,9	
	45	VK45DE	232/316	01.2003		RFN 42 HZDP5	A184	0,9	
I30	3.0	VQ30DE	142/193	01.1997		RFN 58 LZDP5	A187	1,1	
J30	3.0	VG30DE	157/213	01.1992	12.1997	RFN 58 LZDP5	A187	1,1	
Q45	4.1	VH41DE	205/279	01.1993		RFN 58 LZDP5	A187	1,1	

INNOCENTI

ELBA	1.3	146.A5.000	49/67	01.1991	08.1993	RC 62 LS	A6	B17	L65
	1.4 ie	146.C5.000 - 146.D5.000	49/67	09.1993		RC 62 LS	A6	B17	L65
	1.5 ie	149.C1.000 Cat	55/75	03.1992	08.1993	RC 72 LS	A32	B26	L87
	1.6 ie	146.C6.000	55/75	09.1993		RC 72 LS	A32	B26	L87
INNOCENTI	0.55 550	EB	23/31	01.1987	07.1990	RC 62 LS	A6	B17	L65
	0.6 650	AD	23/31	01.1982	04.1986	RC 62 LS	A6	B17	L65
	1.0 990	CB	38/52	01.1982	06.1990	RC 62 LS	A6	B17	L65
	1.0 990 Matic	Z670	38/52	05.1986	12.1990	RC 52 LS	A9	B20	L65
	1.0 ie 100 ie	146.C7.000	35/48	07.1994		RC 52 LS	A9	B20	L65
	1.0 Tre	CB	38-40/52-54	04.1982	04.1986	RC 62 LS	A6	B17	L65
	1.0 Tre Mini Matic	Z670	38-40/52-54	06.1984	04.1986	RC 62 LS	A6	B17	L65
	1.0 Turbo 990 Turbo	G11	53/72	05.1986	12.1990	RC 62 LS	A6	B17	L65
	1.0 Turbo De Tomaso	CB60 - G11	50-53/68-72	01.1983	04.1986	RC 62 LS	A6	B17	L65
KORAL	0.9 45, 1.1 55	100.GL.064 - 128.A.064	33-41/45-56	10.1990		RC 62 LS	A6	B17	L65
	1.3 Cabrio	13CA.064	48/65	06.1991		RC 62 LS5	A24	1,1	L65-5
MILLE	1.0 ie	146.C7.000	35/48	01.1994		RC 52 LS	A9	B20	L65
MILLE CLIP	1.0 ie	146.C7.000	35/48	01.1995		RC 52 LS	A9	B20	L65
	1.4 ie	160.A1.046	51/69	01.1995		RC 62 LS	A6	B17	L65
SMALL	0.6 500	E	23/31	07.1990	12.1992	RC 52 LS	A9	B20	L65
	1.0 990	CB	38/52	07.1990	12.1992	RC 52 LS	A9	B20	L65

ISUZU

117 COUPE	1.8 XC, XE, XG, XT,	G 180		01.1968	05.1981	RC 62 LS	A6	B17	L65
	2.0 XC, XE, XG, XT,	G 200		01.1968	05.1981	RC 62 LS	A6	B17	L65
ASKA	1.8	4ZB1	69-77/94-105	04.1983		RC 52 LS5	A36	B38	L65-5
	1.8 i 16V	EJ18	76/103	06.1990	03.1994	RFC 58 LS5	A38	B48	F54-5
	2.0	4ZC1	61/83	04.1983	06.1990	RC 52 LS5	A36	B38	L65-5
	2.0	4ZC1 Cat	74-81/100-110	04.1983	06.1990	RC 62 LS5	A24	1,1	L65-5
	2.0 i	F20 B Cat	133/181	03.1994	11.1997	RFC 32 LZ5	A117	1,1	
	2.0 i 16V	EJ20 [DOHC] Cat	85/115	06.1990	03.1994	RFC 58 LS5	A38	B48	F54-5

(1) Available until end of stock

(a) 30 000 km

(b) 60 000 km

(c) Grey sticker on ignition coil

(d) Green sticker on ignition coil

(e) Hex 21 mm

(f) Hex 16 mm

(g) Recommended for cold weather



EYQUEM



Box
10

Blister
4



F3-1

ISUZU										
	2.0 i 16V	EJ20 [SOHC] Cat	85/115	06.1991	03.1994	RFC 52 LS5	A26	B24	1,1	F54-5
	2.0 i Turbo	4ZC1T	110/150	04.1983		RC 52 LS5	A36	B38	1,1	L65-5
BELLET	1300, 1500, 1600, 1800, 2000				12.1984	C 62 LS	A4	B5	0,8	L65
BIGHORN / RODEO / TROOPER	2.0	G200Z	60/82	02.1981	10.1991	RC 62 LS5	A24		1,1	L65-5
	2.3	G230	67/91	01.1985	10.1991	RC 72 LS	A32	B26	0,8	L87
	2.3	4ZD1	66/90	01.1987		RC 62 LS5	A24		1,1	L65-5
	2.6 i	4ZE1 Cat	85/115	10.1987	12.1991	RC 62 LS5	A24		1,1	L65-5
	3.2 i V6 24V	6 VD 1 Cat	129/175	10.1991	02.1998	RFC 62 LS5	A42		1,1	F54-5
CAMPO	2300 : 2.3 i, 4WD	4ZD1 Cat	69/94	04.1988	12.1993	RC 62 LS5	A24		1,1	L65-5
ELF	1.6 KAG, KA, 51	G161		01.1974	10.1988	C 62 LS	A4	B5	0,8	L65
	100 : 2.0	NA20S		06.1995	06.1999	RC 52 LS5	A36	B38	1,1	L65-5
	100 : 2.0 i	KA 20 DE		06.1999		RFC 52 LS5	A26	B24	1,1	F54-5
	250 : TLG	G201		01.1974	10.1988	C 62 LS	A4	B5	0,8	L65
FARGO	2.0	4ZC1 Cat	61/83	12.1985		RC 62 LS5	A24		1,1	L65-5
	2.0	NA20S		08.1995		RC 52 LS5	A36	B38	1,1	L65-5
	2.0 Turbo	4ZC1 Cat	111/151	01.1983		RC 62 LS	A6	B17	0,8	L65
	3.0 i	VG30E	118/160	08.1995		RFC 58 LS5	A38	B48	1,1	F54-5
	3.3 i V6	VG33E Cat	110/150	10.1998		RFC 52 LS5	A26	B24	1,1	F54-5
FASTER	2.3	4ZD1	66/90	01.1983	12.1991	RC 62 LS	A6	B17	1,0	L65
	2.3	4ZD1 Cat	66/90	01.1983	12.1991	RC 62 LS5	A24		1,1	L65-5
FLORIAN	1.6 S, GT	G161Z		01.1976	03.1983	C 62 LS	A4	B5	0,8	L65
	1.8 TS	G180Z		01.1976	03.1983	C 62 LS	A4	B5	0,8	L65
GEMINETTE	1.6	EA71		09.1988		RC 62 LS	A6	B17	0,8	L65
GEMINI	1.5	4XC1 Outside Europe	54-63/73-86	11.1984	08.1993	C 52 LS	A1	B1	1,0	L65
	1.5	4XC1 Europe	54-63/73-86	11.1984	08.1993	RC 62 LS5	A24		1,1	L65-5
	1.5	4XC1U Cat	52-63/71-86	11.1984	08.1993	C 52 LS	A1	B1	1,0	L65
	1.5 i	D15 B VTEC-E [SOHC] Cat		01.1995	03.1998	RFC 32 LZ5	A117		1,1	
	1.5 i Turbo	4XC1UT	88/120	02.1988	08.1993	RC 62 LS5	A24		1,1	L65-5
	1.6	G161Z	74/101	01.1974	10.1984	RC 62 LS	A6	B17	0,8	L65
	1.6 i 16V	4XE1-W		03.1990	08.1993	RFC 58 LS5	A38	B48	1,1	F54-5
	1.6 i 16V	D16 A Cat	80/109	08.1993		RFC 62 LS5	A42		1,1	F54-5
	1.6 i 16V	ZC	92/125	08.1993	03.1998	RFC 62 LS5	A42		1,1	F54-5
	1.6 i 16V GTi	4XE1	84-85-92/114-115-125	08.1988	08.1993	RFC 58 LS5	A38	B48	1,1	F54-5
	1.8	G 180	81/110	06.1977	10.1984	RC 62 LS5	A24		1,1	L65-5
KAG	1.6 41, 51	G161		01.1985		C 62 LS	A4	B5	0,8	L65
	1.6 KR 86	G161Z		01.1973	10.1985	RC 62 LS	A6	B17	0,8	L65
MICROBUS	2.0 4 cyl.			01.1983		RC 72 LS	A32	B26	0,8	L87
MIDI	2.0	G200Z	61/83	07.1988		RC 62 LS	A6	B17	0,8	L65
	2.0	4ZC1 Cat	61/83	07.1988		RC 62 LS5	A24		1,1	L65-5
	2.0, 4WD	4ZC1	61/83	06.1988		C 62 LS	A4	B5	0,8	L65
MONTEREY	3.2 i V6 24V	6 VD 1	130/177	06.1992		RFC 58 LS5	A38	B48	1,1	F54-5
MU	2.6 i	4ZE1 Cat	85/115	08.1990	06.1998	RC 62 LS5	A24		1,1	L65-5
	3.2 i V6 24V	6 VD 1 Cat	158/215	08.1990		RFC 62 LS5	A42		1,1	F54-5
NERO	1.5	4XC1	52/71	05.1990	09.1993	RC 62 LS5	A24		1,1	L65-5
	1.6 i 16V	4XE1	84/114	05.1990	09.1993	RFC 58 LS5	A38	B48	1,1	F54-5
	1.6 i 16V	4XE1 Cat	84/114	02.1991	09.1993	RFC 58 LS	A18		0,8	F54
PIAZZA	2.0 i	G200Z	100/136	06.1981		RC 52 LS5	A36	B38	1,1	L65-5
	2.0 i	G200W	67-89/91-121	06.1981		RC 62 LS5	A24		1,1	L65-5
	2.0 i Turbo	4ZC1 Cat	105-133/143-181	09.1985	07.1991	RC 62 LS5	A24		1,1	L65-5
PICK-UP	1.6 KB 10, KB 20, KB 25	G161Z		01.1981		RC 62 LS	A6	B17	0,8	L65
	1.6 KB 26, KB 41			09.1983		RC 62 LS	A6	B17	0,8	L65
	1.6 KB 30, KB 40	G161Z		01.1981		RC 62 LS	A6	B17	0,8	L65
	1.8 KB	G180Z		01.1981		RC 72 LS	A32	B26	0,8	L87
	2.0 KB 28, KB 43, KB 48	G200Z	58/79	02.1984		RC 62 LS	A6	B17	0,8	L65
TROOPER	2.3	4ZD1	66/90	11.1985	12.1991	C 62 LS	A4	B5	0,8	L65
	2.6 i	4ZE1	85/115	10.1987	12.1991	RC 62 LS5	A24		1,1	L65-5
	3.2		130/177	08.1991	07.1998	RFC 52 LS5	A26	B24	1,1	F54-5
VEHICROSS	3.2 i V6 24V	6 VD 1 Cat	158/215	03.1997		RFC 58 LS5	A38	B48	1,1	F54-5
WFR	1.8 11	4ZB1	56/76	06.1983	02.1986	C 62 LS	A4	B5	1,0	L65
	2.0 12	4ZC1 Cat	61/83	02.1986		C 62 LS	A4	B5	1,0	L65
WIZARD	3.2 i V6 24V	6 VD 1 Cat	158/215	06.1998		RFC 62 LS5	A42		1,1	F54-5

IVECO										
Daily I	2.0 30-9, 35-9	6132 BZ 2C0	60/82	12.1981	12.1987	C 62 LS	A4	B5	0,6	L65
GRINTA	2.0 30-9, 35-9	6132 BZ 2C0	60/82	12.1981	12.1987	C 62 LS	A4	B5	0,6	L65

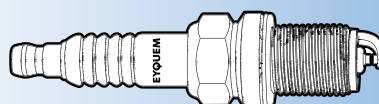

- (1) Available until end of stock
- (a) 30 000 km
- (b) 60 000 km
- (c) Grey sticker on ignition coil
- (d) Green sticker on ignition coil

- (e) Hex 21 mm
- (f) Hex 16 mm
- (g) Recommended for cold weather



KW/HP



Box
10

Blister
4



F3-D1

JAGUAR

DAIMLER	3.6 i L6 24V	AJ6.4 [DOHC] Cat	136-165/185-224	10.1986	08.1989	RFC 52 LS	A3	B16	0,8	F54
	4.0 i 24V	AJ6 [DOHC] Cat	163-175/222-238	09.1989		RFC 52 LS	A3	B16	0,8	F54
E-TYPE	3.8		195/265	01.1961	12.1980	C 52 LS	A1	B1	0,6	L65
	4.2			01.1961	12.1980	C 52 LS	A1	B1	0,6	L65
	5.3 V12		203/276	03.1971	04.1975	C 52 LS	A1	B1	0,6	L65
	2.9	AJ6	104-123/141-167	10.1986	08.1990	C 82 L	A105		0,7	
SOVEREIGN	3.2 24V	AJ6 [OHC]	149-161/203-219	09.1990		RFC 52 LS	A3	B16	0,9	F54
	3.6 i L6 24V	AJ6.4 [DOHC] Cat	135/184	10.1986	08.1989	RFC 52 LS	A3	B16	0,9	F54
	4.0 i 24V	AJ6 [DOHC] Cat	163-175/222-238	09.1989		RFC 52 LS	A3	B16	0,9	F54
	4.2 i	XK	151/205	01.1979	12.1986	RC 62 LS	A6	B17	0,9	L65
	3.4			01.1964	12.1975	C 52 LS	A1	B1	0,6	L65
S-TYPE	3.8			01.1964	12.1975	C 52 LS	A1	B1	0,6	L65
	XJ 6 : 2.8	XK	101/137	10.1968	12.1974	RC 72 LS	A32	B26	0,9	L87
XJ	XJ 6 : 2.9	[OHC] Cat	110/150	01.1986	12.1988	C 82 L	A105		0,6	
	XJ 6 : 2.9	AJ6	123/167	01.1986	12.1990	RC 72 L	A114		0,7	
	XJ 6 : 3.2 24V	AJ6 [OHC]	149-161/203-219	10.1990	09.1997	RFC 52 LS	A3	B16	0,9	F54
	XJ 6 : 3.4	XK [OHC]	120/163	01.1975	12.1986	RC 32 LS	A49	B19	0,9	L3
	XJ 6 : 3.6 i L6 24V	AJ6.4 [DOHC] Cat	135-170/184-231	10.1986	08.1989	RFC 52 LS	A3	B16	0,9	F54
	XJ 6 : 4.0 i 24V	AJ6 [DOHC] Cat	163-175/222-238	09.1989	09.1994	RFC 52 LS	A3	B16	0,9	F54
	XJ 6 : 4.2	XK	125/170	01.1969	12.1979	RC 32 LS	A49	B19	0,9	L3
	XJ 6 : 4.2 i	XK	147-151/200-205	01.1979	12.1986	RC 62 LS	A6	B17	0,9	L65
	XJ 12 : 5.3 i V12	[OHC]	209/284	01.1975	12.1981	RC 62 LS	A6	B17	0,9	L65
	XJR : 4.0 i V6	AJ16 Compressor Supercharged	235/320	08.1994		RFC 82 LS	A76		0,9	F86
	XJR : 4.0 i V6 24V Supercharger	[DOHC]		01.1989	09.1994	RFC 52 LS	A3	B16	0,9	F54
	XJR : 6.0 i V12	[DOHC]	241/328	01.1989	05.1993	C 82 LJS	A52		0,7	J87
	8 3.5		190/258	05.2003		RFN 58 LZDP5	A187		1,1	
	8 4.2		219/298	05.2003		RFN 58 LZDP5	A187		1,1	
	R 4.2		291/395	05.2003		RFN 58 LZDP5	A187		1,1	
	XJS	4.0 i 24V	AJ6 [DOHC] Cat	163-166/222-226	05.1991	10.1996	RFC 52 LS	A3	B16	0,8
5.3 i V12		[OHC]	209/284	01.1975	12.1981	RC 62 LS	A6	B17	0,9	L65
XJSC	3.6 i V6 24V SC Cabriolet	AJ3.6 / AJ6.4 / [DOHC] Cat	146-165/199-224	10.1983	05.1991	RFC 52 LS	A3	B16	0,6	F54
XK 8 Convertible	4.2		219/298	08.2002		RFN 58 LZDP5	A187		1,1	
	R 4.2		291/396	08.2002		RFN 58 LZDP5	A187		1,1	
XK 8 Coupe	4.2		219/298	08.2002		RFN 58 LZDP5	A187		1,1	
	R 4.2		291/396	08.2002		RFN 58 LZDP5	A187		1,1	

JEEP

2000 GTX	2.0 i			01.1991		RC 62 LS	A6	B17	0,8	L65
	2.2 i			01.1988	12.1990	RC 52 LJS	A62	B27	0,7	J65
CHEROKEE	2.4 i 16V			08.2001		RN 22 HJSE6	A180		1,3	
	3.7 V6		155/211	09.2001		RFC 58 LZE5	A75		1,1	F54-5
	3.7 V6		150/204	08.2003		RFC 58 LZE5	A75		1,1	F54-5
	4.0 i		130-136/177-185	01.1987	12.1990	RFC 52 LS	A3	B16	0,7	F54
	4.0 i	XJ [OHV] Cat	126/171	09.1987	12.1996	RFC 52 LS5	A26	B24	1,1	F54-5
	4.0 i	ERH	136/185	09.1990		RFN 42 LZG5	A112		1,1	
	4.0 i	MX	135/184	12.1991		RFN 42 LZG5	A112		1,1	
	4.0 i		131/178	01.1995		RFN 42 LZG5	A112		1,1	
	4.0 i		127/173	07.1998	04.2001	RFN 42 LZG5	A112		1,1	
	4.0 i	Cat	136/185	01.1999		RFC 32 LZ5	A117		1,0	
CJ5 - CJ8	2.0 CJ-7	J5R- 800		01.1983	12.1986	RC 62 LS	A6	B17	0,6	L65
COMANCHE	4.0 i			01.1987	12.1990	RFC 52 LS	A3	B16	0,7	F54
GRAND CHEROKEE	4.0		140/190	04.1999		RFN 42 LZG5	A112		1,1	
	4.0 i		132/180	09.1991	04.1999	RFN 42 LZG5	A112		1,1	
	4.0 i	MX	135/184	09.1991	04.1999	RFN 42 LZG5	A112		1,1	
	4.0 i	Cat	136/185	03.1993	12.1999	RFC 32 LZ5	A117		1,0	
	4.0 i	S01	130/177	10.1995	04.1999	RFN 42 LZG5	A112		1,1	
	4.7 i V8	Cat	169/230	02.1999		RFC 32 LZ5	A117		1,0	
	5.2 i (ZJ)	Y	158/215	09.1992	04.1999	RFC 42 LS	A25		0,9	F54
	5.2 i V8		156/212	09.1992	12.1996	RFC 42 LS5	A83		1,1	F54-5
	5.9 i V8		177/241	09.1996		RFC 42 LS	A25		0,9	F54
	GRAND WAGONEER	5.9 V8			01.1989	12.1991	RC 30 LS	A109		0,9
PREMIER	3.0 i			01.1988	12.1992	RC 52 LJS	A62	B27	0,7	J65
SUMMIT	1.5 i			01.1989	12.1991	RC 62 LS	A6	B17	0,8	L65
	1.6 i Turbo			01.1989	12.1992	RC 62 LS	A6	B17	0,8	L65

(f) Available until end of stock

(a) 30 000 km

(b) 60 000 km

(c) Grey sticker on ignition coil

(d) Green sticker on ignition coil

(e) Hex 21 mm

(f) Hex 16 mm

(g) Recommended for cold weather



EYQUEM



Box
10
Blister
4



F3-1

JEEP										
	1.8 i			01.1992		RFC 42 LS	A25		0,8	F54
	2.4 i			01.1992		RC 32 LS5	A110		1,1	
TALON	1.8 i			01.1993		RC 62 LS	A6	B17	0,8	L65
	2.0 i			01.1990		RC 62 LS	A6	B17	0,8	L65
VISTA	1.5 i			01.1989	12.1991	RC 62 LS	A6	B17	0,8	L65
	1.6 i Turbo			01.1989	12.1990	RC 62 LS	A6	B17	0,8	L65
	2.0 i			01.1989	12.1991	RC 62 LS	A6	B17	0,8	L65
WAGONEER	4.0 i		125/170	01.1990		RFC 52 LS	A3	B16	0,7	F54
WRANGLER I	2.5		76/103	01.1988	12.1991	RFN 42 LZG5	A112		1,1	
	2.5		89/121	12.1991	08.1996	RFN 42 LZG5	A112		1,1	
	4.0		131/178	12.1991	08.1996	RFN 42 LZG5	A112		1,1	
WRANGLER II	2.5	P00	87/118	08.1996		RFN 42 LZG5	A112		1,1	
	4.0	S01	130/177	08.1996		RFN 42 LZG5	A112		1,1	
	4.0		124/169	06.1998		RFN 42 LZG5	A112		1,1	

KIA										
AVELLA	1.3 i 16V	B3 [SOHC] Cat	55/75	03.1994	12.1999	RC 52 LS5	A36	B38	1,1	L65-5
	1.5 i 16V	B5 Cat	74/101	03.1994	12.1999	RC 52 LS5	A36	B38	1,1	L65-5
CAPITAL	1.5	B5	66/90	01.1990		RFC 52 LS5	A26	B24	1,1	F54-5
	1.5 i 16V	B5 Cat	85/115	01.1990		RFC 52 LS5	A26	B24	1,1	F54-5
	1.8 i	F8	70/95	03.1992		RFC 52 LS	A3	B16	1,1	F54
CARENS (FC)	1.8	F8	81/110	11.2000	07.2002	RFC 52 LS	A3	B16	0,8	F54
CARENS II (FJ)	1.6	GA6D	77/105	07.2002		RFC 52 LS5	A26	B24	1,1	F54-5
	1.8	TB	93/126	07.2002		RFC 52 LS	A3	B16	0,8	F54
	2.0 CWT	G4GC	102/139	08.2004		RFC 42 LS5	A83		1,1	F54-5
CARENS III (UN)	1.6 CWT	G4FC	93/126	10.2010		RZC 62 HSET	A526		0,85	
	1.6 CWT	G4FC	97/132	08.2009		RZC 62 HSET	A526		0,85	
CARENS III	2.0 CWT	G4KA	106/144	09.2006		RFC 42 LS5	A83		1,1	F54-5
CARNIVAL I (UP)	2.5 V6	KRV6	121/165	08.1999	10.2001	RFC 58 LZE5	A75		1,1	F54-5
CARNIVAL II (GQ)	2.5 V6	K5	110/150	10.2001	06.2006	RFC 58 LZE5	A75		1,1	F54-5
	3.5	G6CU	143/194	07.2002	04.2006	RFN 58 LZDP5	A187		1,1	
CEE'D (ED)	1.4 CWT	G4FA-L	66/90	06.2010	12.2012	RZC 62 HSET	A526		0,85	
	1.4	G4FA	77/105	12.2006	12.2008	RFC 58 LZE5	A75		1,1	F54-5
	1.4	G4FA	77/105	01.2009	12.2012	RZC 62 HSET	A526		0,85	
	1.4	G4FA	80/109	12.2006	12.2008	RFC 58 LZE5	A75		1,1	F54-5
	1.4	G4FA	80/109	01.2009	12.2012	RZC 62 HSET	A526		0,85	
	1.6	G4FC	85/115	09.2007	12.2008	RFC 58 LZE5	A75		1,1	F54-5
	1.6	G4FC	85/115	01.2009	12.2012	RZC 62 HSET	A526		0,85	
	1.6	G4FC	90/122	12.2006	12.2008	RFC 58 LZE5	A75		1,1	F54-5
	1.6	G4FC	90/122	01.2009	12.2012	RZC 62 HSET	A526		0,85	
	1.6	G4FC	93/126	02.2008	12.2008	RFC 58 LZE5	A75		1,1	F54-5
	1.6	G4FC	93/126	01.2009	12.2012	RZC 62 HSET	A526		0,85	
	1.6 CWT	G4FC	92/125	10.2010	12.2012	RZC 62 HSET	A526		0,85	
	2.0	G4GC	105/143	12.2006	12.2012	RFC 42 LS5	A83		1,1	F54-5
CEE'D SW (ED)	1.4	G4FA	77/105	10.2010	12.2012	RZC 62 HSET	A526		0,85	
	1.4	G4FA	80/109	12.2006	12.2008	RFC 58 LZE5	A75		1,1	F54-5
	1.4	G4FA	80/109	01.2009	12.2012	RZC 62 HSET	A526		0,85	
	1.4 CWT	G4FA-L	66/90	07.2009	12.2012	RZC 62 HSET	A526		0,85	
	1.6	G4FC	85/115	09.2007	12.2008	RFC 58 LZE5	A75		1,1	F54-5
	1.6	G4FC	85/115	01.2009	11.2012	RZC 62 HSET	A526		0,85	
	1.6	G4FC	90/122	09.2007	12.2008	RFC 58 LZE5	A75		1,1	F54-5
	1.6	G4FC	90/122	01.2009	12.2012	RZC 62 HSET	A526		0,85	
	1.6	G4FC	93/126	09.2007	12.2008	RFC 58 LZE5	A75		1,1	F54-5
	1.6	G4FC	93/126	01.2009	12.2012	RZC 62 HSET	A526		0,85	
	1.6 CWT	G4FC	92/125	06.2009	12.2012	RZC 62 HSET	A526		0,85	
	2.0	G4GC	105/143	09.2007	12.2012	RFC 42 LS5	A83		1,1	F54-5
CEE'D (JD)	1.4 CWT	G4FA-L	66/90	05.2012		RZC 62 HSET	A526		0,85	
	1.4 CWT	G4FA	73/100	05.2012		RZC 62 HSET	A526		0,85	
	1.6 CWT	G4FC	92/125	05.2012		RZC 62 HSET	A526		0,85	
CEE'D Sportwagon (JD)	1.4 CWT	G4FA	73/100	09.2012		RZC 62 HSET	A526		0,85	
	1.6 GDI	G4FD	99/135	09.2012		RZC 62 HSET	A526		0,85	
CERATO (LD)	1.6	G4ED	77/105	07.2004		RFC 42 LS5	A83		1,1	F54-5
	2.0	G4GC	105/143	04.2004		RFC 42 LS5	A83		1,1	F54-5
CERATO A (LD)	1.6	G4FC	90/122	05.2006	01.2008	RFC 58 LZE5	A75		1,1	F54-5

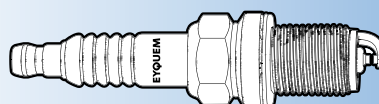

- (1) Available until end of stock
- (a) 30 000 km
- (b) 60 000 km
- (c) Grey sticker on ignition coil
- (d) Green sticker on ignition coil

- (e) Hex 21 mm
- (f) Hex 16 mm
- (g) Recommended for cold weather



KW/HP



Box
10

Blister
4



F3-D1

KIA

	NEW 1.6	G4FC	90/122	02.2008		RZC 62 HSET	A526		0,85	
	1.6	G4ED	77/105	04.2004		RFC 42 LS5	A83		1,1	F54-5
	2.0	G4GC	105/143	04.2004		RFC 42 LS5	A83		1,1	F54-5
CLARUS (K9A)	1.8 i 16V GLX, SLX	T8 [DOHC]	85-92/115-125	02.1996	08.2001	RFC 52 LS	A3	B16	0,9	F54
	2.0 i 16V	FE (16 V)	98/133	07.1996	05.1998	RFC 42 LS5	A83		1,1	F54-5
	2.0 i 16V	FE [DOHC]	98-109/133-148	06.1998	11.2001	RFC 52 LS5	A26	B24	1,1	F54-5
CLARUS Break (GC)	1.8 i 16V	T8 [DOHC]	85/116	05.1998		RFC 52 LS	A3	B16	0,9	F54
	2.0 i 16V	FE [DOHC]	98/133	05.1998		RFC 42 LS5	A83		1,1	F54-5
CONCORDE	1.8 i	F8	70/95	03.1992	06.1995	RFC 58 LS5	A38	B48	1,1	F54-5
	2.0 i	FE [OHC]	73/99	10.1987	06.1995	RFC 52 LS5	A26	B24	1,1	F54-5
JOICE	2.0	G4CP	88/120	09.2001		RC 62 LS5	A24		1,1	L65-5
	2.0	G4CP	102/139	02.2000	09.2001	RC 62 LS5	A24		1,1	L65-5
MAGENTIS (GD, MS)	2.0	G4JP	100/136	05.2001	09.2005	RC 62 LS5	A24		1,1	L65-5
	2.5 V6 (GD)	G6BV	124/169	05.2001		RFN 58 LZDP5	A187		1,1	
	2.5 V6 LPG	G6BV	124/169	05.2001		RFN 62 LZDP5	A185		1,0	
MAGENTIS II (MG)	2.0	G4KA	106/144	11.2005		RFC 42 LS5	A83		1,1	F54-5
	NEW 2.0	G4KD	121/165	07.2009		RFN 52 HZ5	A545		1,05	
MENTOR	1.5 i	[SOHC]	59/80	09.1993		RC 62 LS	A6	B17	0,9	L65
	1.6 i	[SOHC]	60/82	09.1993		RC 62 LS5	A24		1,1	L65-5
	1.6 i	[DOHC]		06.1994		RFC 58 LS5	A38	B48	1,1	F54-5
OPIRUS (GH)	3.5	G6CU	149/203	09.2003		RFN 58 LZDP5	A187		1,1	
	3.5	G6CU	149/203	09.2003		RFN 62 LZDP5	A185		1,0	
PICANTO (BA)	1.0	G4HE	45/61	04/2004		RFC 52 LS5	A26	B24	1,1	F54-5
	1.0	G4HE	46/63	09.2007	01.2011	RFC 42 LS5	A83		1,1	F54-5
	1.1	G4HG	48/65	04.2004		RFC 52 LS5	A26	B24	1,1	F54-5
PICANTO (TA)	NEW 1.0	G3LA	49/67	04.2015		RZC 58 HST	A533		0,9	
	NEW 1.0	G3LA	51/69	05.2011		RZC 58 HST	A533		0,9	
	NEW 1.0 Bi-Fuel	B3LA/G3LA	51/69	05.2011		RZC 58 HST	A533		0,9	
	NEW 1.0 LPG	B3LA	49/67	08.2013		RZC 58 HST	A533		0,9	
	NEW 1.2	G4LA	63/85	09.2011		RZC 58 HST	A533		0,9	
PRIDE (DA)	1.1 i	B1	38/52	01.1990	04.1994	RC 52 LS	A9	B20	0,9	L65
	1.1 i	B1	38/52	05.1996	10.2000	C 62 LS	A4	B5	0,8	L65
	1.3 16V	B3	44/60	01.1990	04.1994	C 62 LS	A4	B5	0,8	L65
	1.3 16V	B3	51/69	05.1994	10.2000	RC 52 LS5	A36	B38	1,1	L65-5
	1.3 16V	B3	47/64	10.1996	05.2001	RC 62 LS5	A24		1,1	L65-5
	1.3 16V	B3	53/72	01.1990	10.1993	C 62 LS	A4	B5	0,8	L65
	1.3 i		51/69	01.1990	05.1996	C 62 LS	A4	B5	0,8	L65
PRIDE Break	1.3	B3A5	47/64	08.1999	05.2001	RC 52 LS5	A36	B38	1,1	L65-5
PRO CEE'D (ED)	1.4	G4FA	77/105	02.2008	12.2008	RFC 58 LZE5	A75		1,1	F54-5
	NEW 1.4	G4FA	77/105	01.2009	09.2012	RZC 62 HSET	A526		0,85	
	1.4	G4FA	80/109	02.2008	12.2008	RFC 58 LZE5	A75		1,1	F54-5
	NEW 1.4	G4FA	80/109	01.2009	09.2012	RZC 62 HSET	A526		0,85	
	NEW 1.4 CVT	G4FA-L	66/90	06.2010	09.2012	RZC 62 HSET	A526		0,85	
	1.6	G4FC	90/122	02.2008	12.2008	RFC 58 LZE5	A75		1,1	F54-5
	NEW 1.6	G4FC	90/122	01.2009	09.2012	RZC 62 HSET	A526		0,85	
	1.6	G4FC	93/126	02.2008	12.2008	RFC 58 LZE5	A75		1,1	F54-5
	NEW 1.6	G4FC	93/126	01.2009	09.2012	RZC 62 HSET	A526		0,85	
	NEW 1.6 CVT	G4FC	92/125	10.2010	02.2013	RZC 62 HSET	A526		0,85	
	2.0	G4GC	105/143	02.2008	12.2012	RFC 42 LS5	A83		1,1	F54-5
PRO CEE'D (JD)	NEW 1.4 CVT	G4FA	73/100	03.2013		RZC 62 HSET	A526		0,85	
RETONA (CE)	2.0 16V	FE (16V)	94/128	05.2000		RFC 52 LS5	A26	B24	1,1	F54-5
RIO A (DC)	1.3	A3E	55/75	09.2000	02.2005	RC 52 LS5	A36	B38	1,1	L65-5
	1.3	A3E	60/82	08.2000	02.2005	RC 52 LS5	A36	B38	1,1	L65-5
	1.5	A5D	70/95	09.2002	02.2005	RFC 52 LS5	A26	B24	1,1	F54-5
	1.5 16V	A5D	72/98	09.2000	02.2005	RFC 52 LS	A3	B16	0,9	F54
RIO Break (DC)	1.3	A3E	55/75	08.2000	07.2002	RC 52 LS5	A36	B38	1,1	L65-5
	1.3	A3E	60/82	08.2000	02.2005	RC 52 LS5	A36	B38	1,1	L65-5
	1.5 16V	A5D	71/97	09.2002	02.2005	RFC 52 LS5	A26	B24	1,1	F54-5
	1.5 16V	A5D	72/98	08.2000	02.2005	RFC 52 LS5	A26	B24	1,1	F54-5
RIO II (JB)	1.4 16V	G4EE	71/97	03.2005		RFC 42 LS5	A83		1,1	F54-5
RIO II A (JB)	1.4 16V	G4EE	71/97	03.2005		RFC 42 LS5	A83		1,1	F54-5
	1.6 16V	G4ED	82/112	03.2005		RFC 42 LS5	A83		1,1	F54-5
RIO III (UB)	NEW 1.2 CVT	G4LA	62/84	11.2014		RZC 58 HST	A533		0,9	
	NEW 1.25 CVT	G4LA	63/86	09.2011		RZC 58 HST	A533		0,9	
	NEW 1.25 LPG	G4LA	63/86	09.2011		RZC 58 HST	A533		0,9	

(f) Available until end of stock

(a) 30 000 km

(b) 60 000 km

(c) Grey sticker on ignition coil

(d) Green sticker on ignition coil

(e) Hex 21 mm

(f) Hex 16 mm

(g) Recommended for cold weather



EYQUEM



Box
10

Blister
4



F3-1

KIA										
	NEW	1.4 CWT	G4FA	80/109	09.2011		RZC 62 HSET	A526		0,85
RIO III A (UB)	NEW	1.2 CWT	G4LA	62/84	11.2014		RZC 58 HST	A533		0,9
	NEW	1.25 CWT	G4LA	63/86	10.2011		RZC 58 HST	A533		0,9
	NEW	1.4 CWT	G4FA	80/109	10.2011		RZC 62 HSET	A526		0,85
ROADSTER		1.8		100/136	08.1999		RFC 58 LS	A18		0,8 F54
SEPHIA		1.5 i	B5	68/92	01.1992	10.1994	RFC 52 LS5	A26	B24	1,1 F54-5
		1.5 i 16V	B5 Cat	77/105	01.1992	10.1994	RFC 52 LS5	A26	B24	1,1 F54-5
SEPHIA (FA)		1.5 i	B5E MMO	59/80	02.1996	12.1997	RC 52 LS5	A36	B38	1,1 L65-5
		1.6 i GTX	B6 [SOHC]	59/80	01.1995	10.1997	RC 62 LS5	A24		1,1 L65-5
		1.8 i 16V	OK24N-OK26Y	82-85/112-115	06.1996	10.1997	RFC 52 LS	A3	B16	0,8 F54
SEPHIA A (FA)		1.5 i	B5	59/80	02.1996	10.1997	RC 52 LS5	A36	B38	1,1 L65-5
		1.6 i	B6	59/80	09.1993	10.1997	RC 62 LS5	A24		1,1 L65-5
		1.8 i 16V	OK24N-OK26Y	82/112	01.1995	10.1997	RFC 52 LS	A3	B16	0,8 F54
SHUMA (FB)		1.5 i 16V LS, RS	B5D	65/88	10.1997	03.2001	RFC 58 LS5	A38	B48	1,1 F54-5
		1.8 i 16V	T8D	82/112	12.1997	03.2001	RFC 58 LS	A18		0,8 F54
SHUMA A (FB)		1.5	OK280	59/80	03.1996	12.1998	RFC 58 LS5	A38	B48	1,1 F54-5
		1.5 i 16V	BFD-ZYVE	65/88	10.1997	10.2001	RFC 58 LS5	A38	B48	1,1 F54-5
SHUMA II (FB)		1.6	GA6D	75/101	05.2001	08.2004	RFC 58 LS5	A38	B48	1,1 F54-5
		1.8 i 16V	T8	84/114	04.2003	08.2004	RFC 52 LS	A3	B16	0,8 F54
SHUMA II A (FB)		1.6	GA6D	75/101	05.2001	05.2004	RFC 58 LS5	A38	B48	1,1 F54-5
SORENTO I (JC)		3.5 V6	G6CU	143/194	08.2002		RFN 58 LZDP5	A187		1,1
		3.5 V6 LPG	G6CU	143/194	08.2002		RFN 62 LZDP5	A185		1,0
SORENTO II (XM)	NEW	2.4 CWT	G4KE	128/174	11.2009		RFN 52 HZ5	A545		1,05
	NEW	2.4 CWT AWD	G4KE	128/174	11.2009		RFN 52 HZ5	A545		1,05
SOUL (AM)	NEW	1.6 CWT	G4FC	77/105	02.2009		RZC 62 HSET	A526		0,85
	NEW	1.6 CWT	G4FC	93/126	02.2009		RZC 62 HSET	A526		0,85
	NEW	1.6 CWT	G4FC	95/129	03.2012		RZC 62 HSET	A526		0,85
SPORTAGE (K00)		2.0 i 4WD	FE (8V)	70/95	04.1994	05.1995	RFC 52 LS	A3	B16	0,9 F54
		2.0 i 4WD	FE (8V)	70/95	06.1995	08.1999	RFC 52 LS5	A26	B24	1,1 F54-5
		2.0, 4WD	FE (16V)	87/118	10.2000	08.2003	RFC 52 LS5	A26	B24	1,1 F54-5
		2.0 i 16V Karmann	FE/FE-DE	94/128	10.1999	08.2003	RFC 58 LS5	A38	B48	1,1 F54-5
		2.0 i 16V 4WD	FE (16V)	94/128	04.1994	08.2003	RFC 58 LS5	A38	B48	1,1 F54-5
SPORTAGE (JE_, KM_)		2.0 16V, 4WD	G4GC	104/141	09.2004		RFC 42 LS5	A83		1,1 F54-5
		2.7 V6 4WD	G6BA	129/175	09.2004		RFC 42 LS5	A83		1,1 F54-5
SPORTAGE (SL)	NEW	2.0 CWT	G4KD	120/163	07.2010		RFN 52 HZ5	A545		1,05
	NEW	2.0 CWT AWD	G4KD	120/163	07.2010		RFN 52 HZ5	A545		1,05
VENGA (YN)	NEW	1.4 CWT	G4FA-L	66/90	02.2010		RZC 62 HSET	A526		0,85
	NEW	1.6 CWT	G4FC	92/125	02.2010		RZC 62 HSET	A526		0,85

LADA										
110		1.5		54/73	01.1995	09.2000	RC 62 LS	A6	B17	0,7 L65
		1.5	VAZ-2111	57/78	01.1995		RC 62 LS	A6	B17	0,7 L65
		1.5 16V	VAZ-2112	70/95	01.1995	09.2000	RC 62 LS	A6	B17	0,7 L65
		1.5 i	VAZ 2111	54-56-58/73-76-79	01.1995		RC 62 LS5	A24		1,1 L65-5
		1.5 i 16V	VAZ 2112	66-69/90-94	01.1996		RFC 58 LS5	A38	B48	1,1 F54-5
		1.5 i 16V		67/91	10.2000		RFC 52 LS5	A26	B24	1,1 F54-5
		1.6	VAZ-21114	60/82	01.2000		RC 62 LS	A6	B17	0,7 L65
		1.6	VAZ-21124	66/90	01.2000		RC 62 LS	A6	B17	0,7 L65
		2.0 i	C 20 XE	110/150	08.1996		RFN 52 LZ	A27		0,9 F54
		2.0 i 16V GTI, Yellow Shark	C 20 XE [DOHC]	110/150	08.1996		RFC 42 LZ2E	A5	B30	1,0 F54
111		1.5	VAZ-2111	57/78	01.1996	09.2000	RC 62 LS	A6	B17	0,7 L65
		1.5		56/76	10.2000		RC 62 LS	A6	B17	0,7 L65
		1.5 16V	VAZ-2112	70/95	01.1995	09.2000	RC 62 LS	A6	B17	0,7 L65
		1.5 16V		67/91	10.2000		RC 62 LS	A6	B17	0,7 L65
		1.5 i 16V	VAZ 2112	58/79	01.1995		RFC 58 LS5	A38	B48	1,1 F54-5
		1.6		60/82	01.2005		RFC 52 LS5	A26	B24	1,1 F54-5
		1.6	VAZ-21124	66/90	03.2006		RFC 52 LS5	A26	B24	1,1 F54-5
112		1.5		54/73	01.1995	09.2000	RC 62 LS	A6	B17	0,7 L65
		1.5	VAZ-2111	57/78	01.1995	09.2000	RC 62 LS	A6	B17	0,7 L65
		1.5 16V	VAZ-2112	70/95	01.1995	09.2000	RC 62 LS	A6	B17	0,7 L65
		1.5 i 16V	VAZ 2112	69/94	01.1995		RFC 58 LS5	A38	B48	1,1 F54-5
		1.5 16V		67/91	10.2000		RC 62 LS	A6	B17	0,7 L65
		1.6	VAZ-21124	66/90	03.2006		RFC 52 LS5	A26	B24	1,1 F54-5
1200 (2101)		1200 : 1.2 (2101, 2102)			01.1970	08.1981	C 62 LS	A4	B5	0,7 L65
1200-1500		1500 : 1.5 (2102, 2103)			09.1972	07.1985	C 62 LS	A4	B5	0,7 L65

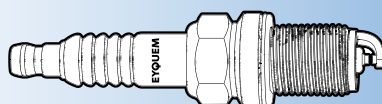

- (1) Available until end of stock
- (a) 30 000 km
- (b) 60 000 km
- (c) Grey sticker on ignition coil
- (d) Green sticker on ignition coil

- (e) Hex 21 mm
- (f) Hex 16 mm
- (g) Recommended for cold weather



KW/HP



Box
10

Blister
4



F3-1

LADA

1200-1600	1600 : 1.6 (2103, 2106, 2107)			09.1972	08.1984	C 62 LS	A4	B5	0,8	L65	
1300 (21011)	1300 : 1.3 (2104, 21011)			08.1974	08.1984	C 62 LS	A4	B5	0,7	L65	
FORMA (SAMARA)	1.1	BA3	39/53	09.1991		RC 62 LS	A6	B17	0,7	L65	
	1.3	Cat	45-48/61-65	09.1991		RC 62 LS	A6	B17	0,7	L65	
	1.5		50-53/68-72	09.1991		RC 62 LS	A6	B17	0,7	L65	
KALINA	1.4 16V	VAZ-11194	66/90	11.2008		RFC 52 LS5	A26	B24	1,1	F54-5	
	1.6	VAZ-21124	60/82	10.2004		RFC 52 LS5	A26	B24	1,1	F54-5	
	1.6	VAZ-21114	60/82	10.2004		RC 62 LS	A6	B17	0,7	L65	
LAIKA	1.5		53/72	02.1993		RC 52 LS	A9	B20	0,7	L65	
	1.6		54/73	02.1993		RC 52 LS	A9	B20	0,7	L65	
NADESCHDA	1.7 i	BA3 2121.4	59/80			RC 62 LS5	A24		1,1	L65-5	
	1.7 i	VAZ 2121.3	62/84			RC 52 LS	A9	B20	0,9	L65	
NATACHA	1.5			01.1996		RC 62 LS5	A24		1,1	L65-5	
NIVA - COSSACK	1600 : 1.6 4x4	VAZ 2121	58/79	12.1976	06.1988	RC 52 LS	A9	B20	0,7	L65	
	1600 : 1.6 4x4		56/76	09.1987		RC 52 LS	A9	B20	0,7	L65	
	1700 : 1.7 i 4x4	VAZ 2112	59-62/80-84	01.1993		RC 52 LS	A9	B20	0,7	L65	
NOVA - KALINKA	1700 i	BA3 21214	59/80	06.1996		RC 32 LS	A49	B19	0,75	L3	
	1300	BA3 2105	48/65	09.1985	06.1988	C 62 LS	A4	B5	0,8	L65	
	1500	BA3 2103	55/75	09.1985	06.1988	C 62 LS	A4	B5	0,8	L65	
	1500	BA3 2103 (KAT)	49/67	08.1994		C 62 LS	A4	B5	0,8	L65	
	1600	BA3 2106	56/76	01.1988	06.1988	C 62 LS	A4	B5	0,8	L65	
	1700		62/84	08.1994		C 62 LS	A4	B5	0,8	L65	
	1.7			01.1996		RC 62 LS5	A24		1,1	L65-5	
	1.7 i	BA3 2121.4	59-62/80-84	08.1994		RC 62 LS5	A24		1,1	L65-5	
	1200 : 1.2	VAZ 21051	44-49/60-67	09.1981	06.1988	RC 62 LS	A6	B17	0,7	L65	
	1300 : 1.3	VAZ 2102	48-53/65-72	05.1981	06.1988	RC 62 LS	A6	B17	0,7	L65	
1400 : 1.4	VAZ 2105	55-56/75-76	05.1981	06.1988	RC 62 LS	A6	B17	0,7	L65		
1500 : 1.5	VAZ 2104 - 2105	52-55/71-75	01.1988		RC 62 LS	A6	B17	0,7	L65		
1500 S		52/71	06.1989		C 62 LS	A4	B5	0,8	L65		
1500 Special	BA3 2103	55/75	03.1985	06.1988	C 62 LS	A4	B5	0,8	L65		
1600 : 1.6	VAZ 2107 BA3 2106	57-62/78-84	05.1981	06.1988	RC 62 LS	A6	B17	0,7	L65		
1700 i Classic		62/84	06.1996		C 62 LS	A4	B5	0,8	L65		
OKA	0.7	VAZ 1111 [SOHC]	22/30	09.1989		RC 62 LS	A6	B17	0,7	L65	
	1.0	A Plus	30/41	01.1995		RC 52 LS	A9	B20	0,8	L65	
PRIORA	1.6	VAZ-21126	72/98	12.2008		RFC 52 LS5	A26	B24	1,1	F54-5	
RIVA	1200 : 1.2	21012 [OHC]	47/64	11.1985		C 62 LS	A4	B5	0,7	L65	
	1300 : 1.3	21056 [OHC]	49/67	11.1985		C 62 LS	A4	B5	0,7	L65	
	1500 : 1.5	21026 [OHC]	55/75	11.1985		C 62 LS	A4	B5	0,7	L65	
	1600 : 1.6	21062 [OHC]	63/86	01.1986		C 62 LS	A4	B5	0,7	L65	
SAGONA	1.1 i					RC 62 LS	A6	B17	0,7	L65	
	1.3 i					RC 62 LS5	A24		1,1	L65-5	
	1.5					RC 62 LS5	A24		1,1	L65-5	
SAMARA	1100	BA3 21081 (KAT)	43/58	02.1996		C 62 LS	A4	B5	0,8	L65	
	1300	BA3 2108	48/65	01.1986	06.1988	C 62 LS	A4	B5	0,8	L65	
	1300		46/63	01.1988	06.1988	C 62 LS	A4	B5	0,8	L65	
	1500	BA3 21083	53/72	01.1988		RC 52 LS	A9	B20	0,8	L65	
	1500	BA3 2111	52/71	02.1995		RC 32 LS	A49	B19	0,75	L3	
	1.1	BA3 21081 Cat	39/53	01.1986	06.1988	RC 62 LS	A6	B17	0,7	L65	
	1.1	BA3 21081	41/56	01.1986	06.1988	RC 62 LS	A6	B17	0,7	L65	
	1.3	VAZ 2108 - 2109	46-48/63-65	01.1986	06.1988	RC 62 LS	A6	B17	0,7	L65	
	1.3 i	VAZ 2108 - 2109 Cat	50/68	02.1996		RC 62 LS5	A24		1,1	L65-5	
	1.5	BA3 - VAZ 21083	50-53-55/68-72-75	01.1986	06.1988	RC 62 LS	A6	B17	0,7	L65	
	1.5 i	Cat	51/69	07.1988		RC 62 LS5	A24		1,1	L65-5	
	SAMARA FORMA	1100	BA3 21081 (KAT)	39/53	07.1991		C 62 LS	A4	B5	0,8	L65
		1300		46/63	05.1990		C 62 LS	A4	B5	0,8	L65
1300		BA3 2108	45/61	07.1991		C 62 LS	A4	B5	0,8	L65	
1300			51/69	02.1996		C 62 LS	A4	B5	0,8	L65	
SAMARA FUN	1.1		39/53	09.1991		RC 62 LS	A6	B17	0,7	L65	
	1.3		45-48/61-65	09.1991		RC 62 LS	A6	B17	0,7	L65	
	1.5		50-53/68-72	09.1991		RC 62 LS	A6	B17	0,7	L65	
SAMARA SPORT	1.5		65/88	01.1996		RC 62 LS5	A24		1,1	L65-5	
TOSCANA	1.3		48/65	01.1986	05.2012	RC 62 LS	A6	B17	0,7	L65	
	1.4	VAZ 2101	55/75	01.1986		RC 62 LS	A6	B17	0,7	L65	
	1.5	BA3 2103	55/75	01.1986	02.1993	RC 62 LS	A6	B17	0,7	L65	
	1.5		55/75	01.1986		RC 62 LS	A6	B17	0,7	L65	

(f) Available until end of stock

(a) 30 000 km

(b) 60 000 km

(c) Grey sticker on ignition coil

(d) Green sticker on ignition coil

(e) Hex 21 mm

(f) Hex 16 mm

(g) Recommended for cold weather



EYQUEM



Box
10

Blister
4



F3 → 1

LAMBORGHINI

COUNTACH	5.0 V12	L 521		01.1982	12.1984	805 LP	A79		0,7	
ESPADA III	4.0 400 GT		350/476	01.1968	12.1980	805 LP	A79		0,6	
	3.9 V12		257/350	05.1982		805 LP	A79		0,6	
ISLERO	3.9 V12 400 GTS		257/350	01.1968	12.1980	C 82 LS	A40	B6	0,6	L87
JALPA	3.5 V8	P 350 Carbu [OHC]	182-188/248-255	01.1981		805 LP	A79		0,6	
JARAMA	4.0 400 GT, GTS		350/476	01.1968	12.1980	805 LP	A79		0,6	
MUIRA	3.9 V12	P 400 S	283/385	01.1968	12.1980	C 82 LS	A40	B6	0,8	L87
URRACO	2.0 V8	P 200	134/182	06.1972	12.1980	805 LP	A79		0,6	

LANCIA

A 112	0.9 Junior, LX	A 112 B...	30-36/41-49	03.1978	12.1986	RC 62 LS	A6	B17	0,7	L65	
	1.0 Elegant, Elite	A 112 B1...	35-36/48-49	01.1971	02.1984	RC 62 LS	A6	B17	0,7	L65	
	1.05 Abarth	A 112 A	52/71	08.1977	02.1984	RC 72 LS	A32	B26	0,7	L87	
BETA	1300 : 1.3			06.1973	12.1984	C 72 LS (1)	A30		0,7	L87	
	1600 : 1.6			06.1973	12.1984	C 72 LS (1)	A30		0,7	L87	
	2000 : 2.0			06.1973	12.1984	C 72 LS (1)	A30		0,7	L87	
	2000 : 2.0 ie	828 CB 1A		05.1980	12.1984	C 62 LS	A4	B5	0,7	L65	
BETA H.P.E.	1600 : 1.6 HPE			06.1973	12.1984	C 72 LS (1)	A30		0,7	L87	
	2000 : 2.0 ie	828 CB 1A		05.1980	12.1984	C 62 LS	A4	B5	0,7	L65	
BETA MONTE CARLO	2000 : 2.0			04.1975	12.1984	C 72 LS (1)	A30		0,7	L87	
DEDRA	1.6 16V	182.A4.000	76/103	01.1996	07.1999	RFC 58 LZK (a)	A11	B29	0,8	F54	
	1.6 i, ie SW	182.A4.000 Cat	76/103	03.1998	01.2000	RFC 58 LZ2	A54		1,0	F54	
	1.6 ie	835.A1.000	66/90	01.1989	07.1992	RC 62 LS	A6	B17	0,7	L65	
	1.6 ie	835.A1.046 Cat	57-63/78-86	08.1989	09.1994	RC 72 LS	A32	B26	0,9	L87	
	1.6 ie	835.C1.000	55/75	04.1993	04.1998	RFN 62 LZ	A71		0,9	F86	
	1.6 ie LE, LS, SW	159.B9.000	66/90	04.1993	04.1998	RFN 62 LZ	A71		0,9	F86	
	1.8 16V	182.A2.000	83/113	03.1996	07.1999	RFC 58 LZK (a)	A11	B29	0,8	F54	
	1.8 GT 16V	183.A1.000	96/131	03.1996	07.1999	RFC 58 LZK (a)	A11	B29	0,8	F54	
	1.8 i, ie LE, LS, LX, SW	182.A2.000 - 183.A1.000	83-96/113-131	01.1996	02.1998	RFC 58 LZ2	A54		1,0	F54	
	1.8 i.e.	835.C5.000	66/90	08.1993	07.1999	RFC 82 LS	A76		0,8	F86	
	1.8 ie LE, SW, Symbol	835.A2.046 - 835.A2.000	77-80/105-109	01.1989	02.1998	RC 72 LS	A32	B26	0,9	L87	
	1.8 ie SW	836.A5.000	74/101	09.1989	12.1995	RC 72 LS	A32	B26	0,9	L87	
	2.0 i, ie 16V LX, SW, 4x4 SW Integrale	836.A3.000 Cat	102/139	10.1994	02.1998	RC 72 LS	A32	B26	0,9	L87	
	2.0 ie LS, SW	835.A5.046	83/113	01.1989	04.1997	RC 72 LS	A32	B26	0,9	L87	
	2.0 ie SW	835.A5.000	86/117	01.1989	10.1994	RC 72 LS	A32	B26	0,9	L87	
	2.0 ie Turbo Integrale, Turbo, 4x4 Turbo Integrale	835.A8.046 Cat	119/162	04.1990	02.1998	C 72 LS3X	A63		0,8	L87	
	2.0 ie Turbo Integrale, Turbo, 4x4 Turbo Integrale	835.A7-A8.000 - 835.A7.046 Cat	121-133/165-181	06.1990	10.1994	C 72 LS3X	A63		0,8	L87	
	DELTA	1.1	831.B8.000	47/64	01.1986	12.1990	RC 62 LS	A6	B17	0,7	L65
		1.3	831.A2.000	55-58/75-79	09.1979	08.1982	RC 62 LS	A6	B17	0,7	L65
		1.3 LX	831.B.000	55-58/75-79	09.1982	08.1992	RC 72 LS	A32	B26	0,7	L87
1.4 ie		160.A1.046	51/69	01.1993		RC 72 LS	A32	B26	0,7	L87	
1.4 ie		836.A4.000	51/69	01.1993		RFN 58 LZ (b)	A7	B28	0,9	F54	
1.4 ie		836.A4.000	51/69	01.1993		RFN 58 LZ3A (g)	A515		0,9		
1.5		831.A - 831.B1	63/86	09.1979	06.1987	RC 72 LS	A32	B26	0,7	L87	
1.5 ie		138.C...	55/75	12.1985	10.1987	RC 72 LS	A32	B26	0,7	L87	
1.6		831.A4...	77/105	11.1982	08.1992	RC 72 LS	A32	B26	0,7	L87	
1.6 HF Turbo		831.B3 - DK	96-103/130-140	06.1983	08.1992	RC 72 LS	A32	B26	0,7	L87	
1.6 i, ie HPE		182.A4-A6.000	66-76/90-103	01.1996		RFC 58 LZ2	A54		1,0	F54	
1.6 i.e.		182.A6.000	66/90	03.1996	08.1999	RFC 58 LZK (a)	A11	B29	0,8	F54	
1.6 i.e. 16V		182.A4.000	76/103	01.1996	08.1999	RFC 58 LZK (a)	A11	B29	0,8	F54	
1.6 ie		835.C1.000	55/75	01.1993	11.1997	RFN 62 LZ	A71		0,9	F86	
1.6 ie HF Turbo		831.B7.046 Cat	97/132	05.1985	08.1992	RC 72 LS	A32	B26	0,7	L87	
1.6 ie HF Turbo		831.A7.000	95/129	01.1992		RC 72 LS	A32	B26	0,7	L87	
1.8 i, ie		182.A2.000	83/113	01.1996		RFC 58 LZ2	A54		1,0	F54	
1.8 i, ie GT, HPE		183.A1.000	96/131	01.1996		RFC 58 LZ2	A54		1,0	F54	
1.8 i.e. 16V		182.A2.000	83/113	03.1996	08.1999	RFC 58 LZK (a)	A11	B29	0,8	F54	
1.8 i.e. 16V GT		183.A1.000	96/131	03.1996	08.1999	RFC 58 LZK (a)	A11	B29	0,8	F54	
1.8 ie	836.A5.000	74/101	01.1993		RC 72 LS	A32	B26	0,7	L87		
1.8 ie 16V	835.C2.000 Cat	76/103	01.1993	12.1995	RC 72 LS	A32	B26	0,7	L87		
1.8 ie 16V Turb S4 Volumex		184/250	09.1985	12.1990	RC 82 LS	A78		0,7	L87		
1.8 ie GT	836.A6.000	66/90	01.1993		RC 72 LS	A32	B26	0,7	L87		
1.8 ie LE	835.C4.000	66/90	01.1993	11.1997	RC 72 LS	A32	B26	0,7	L87		
16 : 2.0 ie 16V Turb Evolution	831.E5.000 - 831.E5.046	151-155/205-211	03.1991	11.1997	RC 58 LZ3EX	A34	B54	0,9	L65		

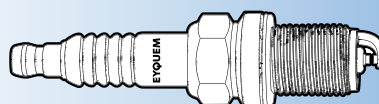

(1) Available until end of stock
 (a) 30 000 km
 (b) 60 000 km
 (c) Grey sticker on ignition coil
 (d) Green sticker on ignition coil

(e) Hex 21 mm
 (f) Hex 16 mm
 (g) Recommended for cold weather



KW/HP



Box
10

Blister
4



F3-1

LANCIA

	2.0 16V Turbo	175 A4.000	142/193	07.1996	08.1999	RFC 52 LS	A3	B16	0,8	F54
	2.0 i Turbo Integrale	831.GH8E.000	130/177	03.1989	12.1992	RC 72 LS	A32	B26	0,7	L87
	2.0 i, ie 16V GT, HPE	836.A3.000 Cat	102/139	01.1993	11.1997	RC 72 LS	A32	B26	0,7	L87
	2.0 ie 16V Turb HF Integrale, HF Integrale 4x4, Turbo Integrale	831.D5.000 - 831.D5.04	144-147/196-200	01.1989		C 72 LS3X	A63		0,8	L87
	2.0 ie 16V Turb HF Turbo Integrale	831.C5.000	133/181	05.1986	02.1989	C 72 LS3X	A63		0,8	L87
	2.0 ie 16V Turb HPE	836.A2.000 Cat	137/186	01.1993	11.1997	C 62 LS3X	A13	B15	0,8	L65
	2.0 ie 16V Turb HPE	175.A4.000	142/193	12.1997		RFC 62 LS3X	A59		0,9	F86
	2.0 ie Turbo HF 4x4	831.B5.000	122/166	05.1986	02.1989	C 72 LS3X	A63		0,8	L87
	2.0 ie Turbo HF Integrale, HF Turbo	831.C5.046	130/177	07.1992	11.1997	C 72 LS3X	A63		0,8	L87
DELTA III (844)	NEW 1.4	198 A4.000	88/120	09.2008		RZC 82 LSDPT	A535		0,85	
	NEW 1.4 16V	198 A7.000	103/140	07.2010		RZC 82 LSDPT	A535		0,85	
	NEW 1.4	198 A1.000	110/150	09.2008		RZC 82 LSDPT	A535		0,85	
GAMMA	2000 : 2.0 Berlina			09.1976	12.1984	C 82 LS	A40	B6	0,7	L87
	2000 : 2.0 Coupé			09.1976	12.1984	C 82 LS	A40	B6	0,7	L87
	2500 : 2.5 Berlina			05.1976	12.1984	C 82 LS	A40	B6	0,7	L87
	2500 : 2.5 Coupé			05.1976	12.1984	C 82 LS	A40	B6	0,7	L87
	2500 : 2.5 ie ie Berlina			06.1980	12.1984	C 82 LS	A40	B6	0,7	L87
	2500 : 2.5 ie ie Coupé			06.1980	12.1984	C 82 LS	A40	B6	0,7	L87
KAPPA	2.0 ie 16V Turb	838.A4.000	151/205	11.1994	06.1998	C 72 LS3X	A63		0,8	L87
	2.0 ie 20V LE, LS	838 A1.000	107-110/146-150	10.1994	06.1998	RFC 58 LZ2	A54		1,0	F54
	2.0 ie 20V LS	838 A6.000	114/155	11.1994		RFC 58 LZ2	A54		1,0	F54
	2.0 ie 20V Turb	175.A3.000	162/220	06.1998		RFC 58 LZ3EX	A58	B55	0,9	F54
	2.4 20V	838 A2.000/838 A2.027	129/175	08.1994	10.2001	RFC 58 LZK (a)	A11	B29	0,8	F54
	2.4 20V,Coupé	838 A2.000	129/175	11.1996	03.2001	RFC 58 LZK (a)	A11	B29	0,8	F54
	2.4 ie 20V	838.B2.000	129/175	06.1998		RFC 58 LZ2	A54		1,0	F54
	2.4 ie 20V Coupé, LE, LS, LX	838 A2.000	129/175	08.1994		RFC 58 LZ2	A54		1,0	F54
	3.0 24V (838BD11A)	838 B.000	150/204	07.1996	10.2001	FN 58 LZDPR	A198		0,75	
LYBRA	1.6 16V	182 A4.000/182 B6.000	76/103	07.1999		RFC 58 LZK (a)	A11	B29	0,8	F54
	1.6 i, ie SW	182.A4.000 Cat	76/103	09.1999		RFC 58 LZ2	A54		1,0	F54
	1.8 16V	839 A4.000/839 A7.000/ 839 A9.000	96/131	07.1999		RFC 58 LZK (a)	A11	B29	0,8	F54
	1.8 i 16V SW	839.A4.000	96/131	09.1999		RFC 58 LZ2	A54		1,0	F54
	2.0 20V	182 B7.000	113/154	07.1999	09.2000	RFC 58 LZK (a)	A11	B29	0,8	F54
	2.0 20V	185 A8.000	110/150	09.2000		RFC 58 LZK (a)	A11	B29	0,8	F54
	2.0 i 20V SW	182.B7.000	114/155	09.1999		RFC 58 LZ2	A54		1,0	F54
MUSA	1.4	843 A 1.000	70/95	10.2004		RZC 58 LS	A190	B59	0,9	
	1.4	350 A1.000	57/78	09.2005		RZC 62 LSE	A510		1,0	
	1.4	192 B 2.000	66/90	10.2007		RZC 62 LS 5	A509		1,0	
PHEDRA	2.0 i 16V	EW10 J4-L4 [RFN] [DOHC]	100/136	06.2002		RFN 52 HZ	A157	B50	0,9	
	2.0 i 16V	EW10 J4-L4 [RFN] [DOHC]	100/136	06.2002		RFN 52 HZ3A (g)	A100		0,9	
PRISMA	1.3 ie	138 C	55-63/75-86	12.1982	12.1989	RC 72 LS	A32	B26	0,7	L87
	1.5	138 C	55-63/75-86	12.1982	12.1989	RC 72 LS	A32	B26	0,7	L87
	1.5 ie	138 C	55-63/75-86	12.1982	12.1989	RC 72 LS	A32	B26	0,7	L87
	1.6 ie	831...	66-74-77-80/ 90-101-105-109	12.1982	12.1989	RC 72 LS	A32	B26	0,7	L87
THEMA	2.0 ie 4x4, Integrale	831.B4.046 - 831.B4.000	82-85/112-115	04.1986	12.1989	RC 72 LS	A32	B26	0,7	L87
	2.0 ie	834.B1.000	86/117	09.1984	05.1992	RC 72 LS	A32	B26	0,7	L87
	2.0 ie	834.B.000	88/120	11.1984	05.1992	RC 72 LS	A32	B26	0,7	L87
	2.0 ie	834.B.146	85/115	03.1986	01.1995	RC 72 LS	A32	B26	0,7	L87
	2.0 ie 16V	834.B2.246	104/141	01.1987	08.1992	C 72 LS3X	A63		0,8	L87
	2.0 ie 16V	834.F1.000	112/152	01.1992	01.1995	RC 72 LS	A32	B26	0,7	L87
	2.0 ie 16V Turbo	834.B2.000	108/147	06.1987	05.1992	RC 72 LS	A32	B26	0,7	L87
	2.0 ie 16V Turbo	834.F2.000	148/201	10.1991	01.1995	C 72 LS3X	A63		0,8	L87
	2.0 ie 16V Turbo	834.C1.000 - 834.C1.246	132-148/180-201	01.1987	01.1995	C 72 LS3X	A63		0,8	L87
	2.0 ie Turbo	834.C.146 - 834.C.000	110-122/150-166	11.1984	05.1992	C 72 LS3X	A63		0,8	L87
	2.8 ie V6	PRV 834 AB	110/150	10.1984	09.1988	RC 72 LJS3	A80		1,2	
	2.9 ie V6	PRV 834 E 146	108/147	06.1988	08.1992	RC 72 LJS3	A80		1,2	
	2000 16V Turbo	834 C1.000	133/181	12.1988	06.1990	C 62 LS3X	A13	B15	0,9	L65
	2000 i.e. 16V Turbo	834 C1.246	130/177	04.1989	05.1992	C 62 LS3X	A13	B15	0,9	L65
	3.0 ie V6	834.F.000	126/171	01.1992	01.1995	RC 72 LS	A32	B26	0,7	L87
TREVI	1.6	828.B	74/101	01.1980	12.1984	RC 72 LS	A32	B26	0,7	L87
	2.0 ie	828.B1...	86-90/117-122	01.1980	12.1984	RC 62 LS	A6	B17	0,7	L65
	2.0 Volumex	828.B1...	85-100/116-136	01.1980	12.1984	RC 72 LS	A32	B26	0,7	L87
Y	1.1	176 B2.000	40/54	11.1995		RFN 52 LZ	A27		0,9	F54

(f) Available until end of stock

(a) 30 000 km

(b) 60 000 km

(c) Grey sticker on ignition coil

(d) Green sticker on ignition coil

(e) Hex 21 mm

(f) Hex 16 mm

(g) Recommended for cold weather



EYQUEM



Box
10

Blister
4



F3-1

LANCIA										
	1.2	188 A4.000/840 A3.000	44/60	03.1996		RFN 52 LZ	A27		0,9	F54
	1.2 ie LE, LS	840.A3.000	44/60	01.1996		RFN 58 LZ (b)	A7	B28	0,8	F54
	1.2 ie LE, LS	840.A3.000	44/60	01.1996		RFN 58 LZ3A (g)	A515		0,8	
	1.2 16V	176 B9.000	63/86	04.1997		RZC 58 LS	A190	B59	0,9	
	1.2 16V	188 A5.000	59/80	10.2000		RZC 58 LS	A190	B59	0,9	
	1.4 ie 12V LS, LX	840.A2-A4.000	55-59/75-80	01.1996		RFC 58 LZ2	A54		1,0	F54
Y10	1.0 Fire, 4WD	156 A 2.100	32/44	06.1985	02.1989	C 62 LS	A4	B5	0,8	L65
	1.0 Fire, Fire Appia, Mia, 4x4	156.A2.000	33-37/45-50	03.1985	06.1991	RFC 52 LS	A3	B16	0,8	F54
	1.0 ie Fire	156.A2.100	32/44	03.1985	06.1991	RFC 52 LS	A3	B16	0,8	F54
	1.0 ie Fire	156.A2.256	33-37/45-50	03.1985	02.1992	RFN 58 LZ (b)	A7	B28	0,9	F54
	1.0 ie Fire	156.A2.256	33-37/45-50	03.1985	02.1992	RFN 58 LZ3A (g)	A515		0,9	
	1.0 ie Fire 4x4	156.A3.000	37/50	09.1986	12.1995	RFC 52 LS	A3	B16	0,8	F54
	1.0 ie Fire, 4x4	156.A2.146	33/45	03.1985	07.1989	RFC 52 LS	A3	B16	0,8	F54
	1.05 Touring	156.A.000	38-41/52-56	03.1985	02.1989	RC 62 LS	A6	B17	0,7	L65
	1.05 Turbo	156.A1.000	62/84	03.1985	02.1989	RC 82 L	A94		0,7	
	1.1 Avenue, 4WD	176 B2.000	40/54	01.1995	12.1995	RFN 52 LZ	A27		0,9	F54
	1.1 i, ie	176.B2.000	40-43/54-58	02.1995	12.1995	RFC 52 LS	A3	B16	0,8	F54
	1.1 i.e. Fire, 4WD	156 C.046	37/50	07.1989	12.1995	RFN 52 LZ	A27		0,9	F54
	1.1 ie Fire 4x4, Appia LX, Avenue, LX, Selectronic	156.C.000	41/56	01.1989	09.1992	RFC 52 LS	A3	B16	0,8	F54
	1.1 ie Fire, 4x4, Avenue/Clim, Clim, Elite Clim, LX, Selectronic	156.C.046 Cat	37/50	09.1986	12.1995	RFN 58 LZ (b)	A7	B28	0,9	F54
	1.1 ie Fire, 4x4, Avenue/Clim, Clim, Elite Clim, LX, Selectronic	156.C.046 Cat	37/50	09.1986	12.1995	RFN 58 LZ3A (g)	A515		0,9	
	1.3 ie GT	156.B.000	57/78	11.1987	12.1995	RC 62 LS	A6	B17	0,7	L65
	1.3 ie GT, Elite	146.A5.000 - 146.A5.046	53-57/73-78	11.1987	12.1995	RC 62 LS	A6	B17	0,7	L65
YPSILON	1.2	188 A4.000	44/60	10.2003	11.2004	RFC 42 LS	A25		0,9	F54
	1.2	188 A4.000	44/60	12.2004		RZC 58 LS	A190	B59	0,9	
	1.2	188 A5.000	59/80	10.2003		RZC 58 LS	A190	B59	0,9	
	1.4	843 A 1.000	70/95	10.2003		RZC 58 LS	A190	B59	0,9	
	1.4	350 A1.000	57/78	02.2006		RZC 62 LSE	A510		1,0	
YPSILON II	1.2	169 A 4.000	51/69	05.2011		RZC 62 LSE	A510		1,0	
ZETA	1.8 i	XU7 JP [LFW]	76/103			RFC 58 LZK (a)	A11	B29	0,9	F54
	1.8 i	XU7 JP [LFW]	76/103			RFN 58 LZ (b)	A7	B28	0,9	F54
	1.8 i	XU7 JP [LFW]	76/103			RFN 58 LZ3A (g)	A515		0,9	
	2.0 16V	RFV	97/132	06.1999	07.2000	RFC 52 LS	A3	B16	0,9	F54
	2.0 16V	RFN	100/136	07.2000	09.2002	RFN 52 HZ	A157	B50	0,9	
	2.0 i	XU10 J2C [RFU]	89/121	07.1995		RFC 58 LZK (a)	A11	B29	0,9	F54
	2.0 i	XU10 J2C [RFU]	89/121	07.1995		RFN 58 LZ (b)	A7	B28	0,9	F54
	2.0 i	XU10 J2C [RFU]	89/121	07.1995		RFN 58 LZ3A (g)	A515		0,9	
	2.0 i Turbo	XU10 J2TE [RGX]	107/145	09.1994		RFN 58 LZ (b)	A7	B28	0,9	F54
	2.0 i Turbo	XU10 J2TE [RGX]	107/145	09.1994		RFN 58 LZ3A (g)	A515		0,9	
	2.0 Turbo	RGX	108/147	05.1995	09.2002	RFN 52 LZ	A27		0,9	F54
LAND ROVER										
DEFENDER	2.5		62/84	08.1990		C 62 LS	A4	B5	0,8	L65
	3.5 V8		100/136	08.1990		RC 52 LS	A9	B20	0,8	L65
	3.9 i V8		134/182	09.1992		RC 72 LS	A32	B26	0,8	L87
	3.9 V8		136/185	11.1998		RC 32 LS	A49	B19	0,75	L3
DISCOVERY	2.0 i 16V	T16 [DOHC]	100/136	10.1993		RFC 58 LS	A18		0,8	F54
	3.5 i V8	22D	113/154			RC 30 LS	A109		0,8	
	3.5 i V8	24D	122/166			RC 62 LS	A6	B17	0,8	L65
	3.5 V8	27G	83/113			RC 62 LS	A6	B17	0,8	L65
	3.5 V8 Style		107/145	09.1989		RC 62 LS	A6	B17	0,8	L65
	3.9 i V8	36D	134/182	09.1993		RC 32 LS	A49	B19	0,8	L3
	4.0 i V8		136/185	01.1999		RC 62 LS	A6	B17	0,8	L65
FREELANDER	1.8 i 16V	K16 Series 18K4F [DOHC] Cat	88/120	01.1997		RFN 58 LZ (b)	A7	B28	0,8	F54
	1.8 i 16V	K16 Series 18K4F [DOHC] Cat	88/120	01.1997		RFN 58 LZ3A (g)	A515		0,8	
	1.8 16V	18 K4F	86/117	11.2000		RFN 58 LZDP5	A187		1,1	
	1.8 i 16V		88/120	02.1998	11.2000	RFN 58 LZDP5	A187		1,1	
	2.5 V6	25 K4F	130/177	11.2000		RFN 58 LZDP5	A187		1,1	
LAND-ROVER	109 : 3.5 V8					RC 62 LS	A6	B17	0,8	L65
	88/109 : 2.3	8:1 CR				RC 32 LS	A49	B19	0,8	L3
	90/110 : 2.3	8:1 CR				RC 32 LS	A49	B19	0,8	L3
	90/110 : 2.5			09.1983	07.1990	RC 62 LS	A6	B17	0,8	L65

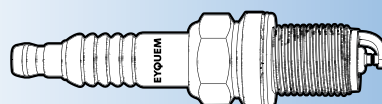

(1) Available until end of stock
 (a) 30 000 km
 (b) 60 000 km
 (c) Grey sticker on ignition coil
 (d) Green sticker on ignition coil

(e) Hex 21 mm
 (f) Hex 16 mm
 (g) Recommended for cold weather



KW/HP



Box
10

Blister
4



F3→1

LAND ROVER

	90/110 : 3.5 V8			09.1983	07.1990	RC 62 LS	A6	B17	0,8	L65
	90/110 : 3.9 i V8			01.1992		RC 72 LS	A32	B26	0,8	L87
RANGE ROVER	3.5 i V8	LC				RC 32 LS	A49	B19	0,8	L3
	3.5 i V8	(F)	110/150	10.1985	09.1990	C 62 LS	A4	B5	0,8	L65
	3.5 V8	V8F	93/126	08.1981	09.1990	C 62 LS	A4	B5	0,8	L65
	3.5 V8 thread 12,7 mm				12.1996	C 32 S	A8	B3	0,8	N43
	3.5 V8 thread 19 mm				12.1996	C 52 LS	A1	B1	0,8	L65
	3.9 i V8 Classic	LC	127-134-140/ 173-182-190	11.1987	07.1994	RC 32 LS	A49	B19	0,8	L3
	4.0 i V8 SE	42D	140/190	09.1994	12.1998	RC 32 LS	A49	B19	0,8	L3
	4.2 i V8	HC	149/203	09.1992	09.1994	RC 32 LS	A49	B19	0,8	L3
	4.4		210/286	03.2002		RFC 58 LZ2E	A10	B31	0,9	F54
	4.6	46 D	165/225	07.1994	03.2002	RC 62 LS	A6	B17	0,8	L65
	4.6		160/218	06.1998	03.2002	RC 62 LS	A6	B17	0,8	L65
	4.6 i V8 HSE	46D	166/226	09.1994	12.1998	RC 32 LS	A49	B19	0,8	L3
RANGE ROVER III	4.4		210/286	03.2002		RFC 58 LZ2E	A10	B31	0,9	F54

LEXUS

ES	3.0	1MZ-FE	157/213	08.2001	10.2006	RFN 62 LZDP5	A185		1,0	
CT (ZWA10_) NEW	200h	2ZR-FXE	73/99	12.2010		RWN 42 HSI PW	A544		1,0	
IS	200	1G-FE	114/155	04.1999	07.2005	RFN 62 LZDP5	A185		1,0	
LS	400	1UZ-FE	194/264	12.1994	08.1997	RFC 52 LZDP	A152		0,9	
	460	1UR-FSE	280/381	04.2006		RFC 58 HZEDP5	A191		1,1	
RX	300	1MZ-FE	150/204	05.2003	12.2008	RFN 62 LZDP5	A185		1,0	
	400h	3MZ-FE	155/211	09.2004		RFC 62 LSDP5	A507		1,1	
	400h FWD	3MZ-FE	155/211	09.2005		RFC 62 LSDP5	A507		1,1	
SC	430	3UZ-FE	210/286	05.2001	07.2010	RFN 62 LZDP5	A185		1,0	

LEYLAND-DAF

200	1.7	O Series	45-52/61-71	04.1989		C 62 LS	A4	B5	0,8	L65
	2.0	O Series	51-62-67/69-84-91	04.1989		C 72 LS (1)	A30		0,8	L87
400	2.0	O Series	51-62-67/69-84-91	04.1989		C 72 LS (1)	A30		0,8	L87
	3.5 V8		105/143	04.1989		RC 32 LS	A49	B19	0,8	L3

LEYLAND-FREIGHT ROVER

SHERPA	1.7 200	Leyland-Daf	45-52/61-71	11.1986		C 72 LJS	A22		0,7	J87
	1.7 230, 250, 255, 280	Leyland-Daf	45-52/61-71	11.1986		C 72 LJS	A22		0,7	J87
	2.0 200	Leyland-Daf	63-66/86-90	11.1986		C 72 LJS	A22		0,7	J87
	2.0 230, 250, 255, 280	Leyland-Daf	63-66/86-90	11.1986		C 72 LJS	A22		0,7	J87
	200 : 1.7		52/71	01.1978	12.1986	C 52 LJS	A23		0,8	J65
	200 : 1.7		52/71	01.1987	01.1989	C 62 LS	A4	B5	0,8	L65
	200 : 2.0		67/91	01.1978	12.1986	C 52 LJS	A23		0,8	J65
	200 : 2.0		67/91	01.1987	01.1989	C 72 LS (1)	A30		0,8	L87
	3.6	Leyland-Daf	105/143	11.1986		RC 32 LS	A49	B19	0,8	L3
	300 : 2.0		67-73/91-99	09.1983	05.1986	C 72 LS (1)	A30		0,8	L87
	300 : 3.6 V8		106/144	11.1985	03.1989	C 62 LS	A4	B5	0,8	L65

LOTUS

ECLAT	2.0 16V	Mot. 907	118/160	01.1975	12.1982	RC 72 LS	A32	B26	0,7	L87
	2.2 16V		118/160	01.1980	12.1982	RC 72 LS	A32	B26	0,7	L87
	2.2 16V	Lotus 912	119/162	05.1980	08.1986	C 72 LS (1)	A30		0,7	L87
ELAN	1.5			01.1963	12.1975	RC 72 LS	A32	B26	0,7	L87
	1.6		88-93/120-126	01.1963	12.1975	RC 72 LS	A32	B26	0,7	L87
	1.6 i 16V Turbo	4XE1	123/167	09.1989	07.1992	RFN 62 LZ	A71		0,8	F86
	S2 : 1.6 i 16V Turbo		115/156	01.1994		RFN 62 LZ	A71		0,8	F86
ELISE	1.8 16V	18 K4F	88/120	08.1995	11.2000	RFC 52 LZDP5	A149		0,9	
	1.8 i 16V	K16 Series 18K4F [DOHC] Cat	88/120	01.1996		RFN 62 LZ	A71		0,8	F86
ELITE	2.0 16V	Mot. 907	114-118/155-160	01.1973	12.1980	RC 72 LS	A32	B26	0,7	L87
	2.2 16V	Lotus 912	118/160	01.1980	12.1982	RC 72 LS	A32	B26	0,7	L87
ESPRIT	2.2 Sport 300		225/306	01.1993		RC 72 LS	A32	B26	0,7	L87
	2.2 Turbo Turbo SE	Mot. 910	157/214	02.1980	01.1993	RC 82 LS	A78		0,7	L87
	3.5 i V8 32V Tw	Mot. 618 [2 x DOHC]	260/354	03.1996		RFC 58 LZ2E	A10	B31	0,9	F54
	3.5 V8 32V Turbo	618	260/354	02.1996		RFC 58 LZK (a)	A11	B29	0,8	F54
	S3 : 2.0 16V	Mot. 907	118/160	01.1974	12.1980	RC 72 LS	A32	B26	0,7	L87
	S3 : 2.2 16V	Lotus 912	118-134/160-182	01.1980	07.1992	RC 72 LS	A32	B26	0,7	L87

(f) Available until end of stock

(a) 30 000 km

(b) 60 000 km

(c) Grey sticker on ignition coil

(d) Green sticker on ignition coil

(e) Hex 21 mm

(f) Hex 16 mm

(g) Recommended for cold weather



EYQUEM



Box
10

Blister
4



F3-1

LOTUS

	S4 : 2.2 Turbo Turbo SE	Mot. 910 S	197/268	02.1980	01.1993	RC 82 LS	A78		0,7	L87
EUROPA	S2 : 2.0, Special, Twin Cam			01.1968	12.1975	C 72 LS (1)	A30		0,7	L87
EXCEL	2.2 16V SA, SE	Lotus 912 - 912 S	118-1335/160-184	10.1983	07.1992	RC 72 LS	A32	B26	0,7	L87
SEVEN	1.4	[OHV]		01.1962	12.1972	RC 62 LS	A6	B17	0,7	L65
	1.5	[OHV]		01.1962	12.1972	RC 62 LS	A6	B17	0,7	L65
	1.5 Twin Cam			01.1965	12.1975	RC 72 LS	A32	B26	0,7	L87
	1.6	[OHV]		01.1962	12.1972	RC 62 LS	A6	B17	0,7	L65
	1.6 Twin Cam			01.1965	12.1975	RC 72 LS	A32	B26	0,7	L87

LUMINA APV

LUMINA APV	2.3	LD2	108/147	12.1992	07.1996	RFC 52 LS	A3	B16	0,8	F54
SPECTRUM	1.5			01.1985	12.1988	RC 32 LS5	A110		1,1	
	1.5 i Turbo	(9)		01.1987	12.1988	RC 32 LS5	A110		1,1	
SPRINT	0.9			01.1985	12.1988	RC 32 LS5	A110		1,1	
	0.9 i Turbo	(2)		01.1987	12.1988	RC 62 LS	A6	B17	0,8	L65

MASERATI

800	0.8 i	F Serie	26/35	10.1990		C 52 LS	A1	B1	0,8	L65
222 / 228	222 : 2.0 V6	Mot. 471..	164/223	01.1988		C 82 LS	A40	B6	0,8	L87
	222 : 2.8 V6 SE	Mot. 473 Cat	165/224	01.1988	10.1992	C 82 LS	A40	B6	0,8	L87
	228 : 2.8 V6	Mot. 473	182/248	07.1987	12.1990	C 82 L	A105		0,7	
	228 : 2.8 V6 Bi-Turbo	Mot. 473	184-188/250-256	12.1984	12.1990	C 82 LS	A40	B6	0,8	L87
420 / 430	420 : 2.0	Mot. 452	133-136/181-185	03.1985	12.1986	C 82 LS	A40	B6	0,7	L87
	420 : 2.0 i	Mot. 470	138/188	01.1987		C 82 LS	A40	B6	0,7	L87
	422 : 2.0 V6	Mot. 471	164/223	01.1988		C 82 LS	A40	B6	0,7	L87
	430 : 2.8 V6	Mot. 473	182/248	02.1988		C 82 L	A105		0,7	
	430 i	473	182/248	02.1988	12.1994	C 82 L	A105		0,4	
BITURBO	2.0	Mot. 452	133-136/181-185	07.1985	04.1987	C 82 LS	A40	B6	0,7	L87
	2.0 V6 Si	Mot. 471	151/205	09.1987	12.1988	C 82 L	A105		0,8	
	2.5 Si	Mot. 453	138/188	09.1987	12.1988	C 72 LS (1)	A30		0,7	L87
	425 : 2.5	Mot. 453	140-147/190-200	01.1987	08.1987	C 82 L	A105		0,8	
	425 : 2.5 i	Mot. 453	138/188	09.1987	12.1988	C 72 LS (1)	A30		0,7	L87
	Si 2.0,Coupé	471..	151/205	09.1987	12.1988	C 82 L	A105		0,4	
BORA	Tous modèles (all models)			01.1971	12.1983	RC 62 LS	A6	B17	0,7	L65
GUARA	4.0		213/290			RFN 58 LZ (b)	A7	B28	0,7	F54
	4.0		213/290			RFN 58 LZ3A (g)	A515		0,7	
KARIF	2.8 i V6	Mot. 473 Cat	165/224	04.1988		C 82 LS	A40	B6	0,8	L87
	2.8 i V6	Mot. 473	182/248	04.1988		C 82 L	A105		0,7	
KHAMSIN	5.0 V8	115.49	235/320	01.1972	12.1982	C 62 LS	A4	B5	0,7	L65
KYALAMI	4.1	107.21.42	188/256	04.1976	12.1985	C 82 LS	A40	B6	0,6	L87
	4.9	107.22.49	206/280	04.1976	12.1985	C 82 LS	A40	B6	0,6	L87
MERAK	2.0 V6 2000	114.62.20	125/170	05.1975	12.1983	C 62 LS	A4	B5	0,7	L65
	3.0 V6 SS	114.50.30	162/220	05.1975	12.1983	C 62 LS	A4	B5	0,7	L65
QUATTRO-PORTE	4.1	107.21.42	188/256	08.1976	12.1989	C 82 LS	A40	B6	0,6	L87
	4.9	107.22.49	206/280	08.1976	12.1989	C 82 LS	A40	B6	0,6	L87
SEBRING	3.7 V8	Cat		01.1969	12.1978	C 82 LS	A40	B6	0,8	L87
	4.0 V8	Cat		01.1969	12.1978	C 82 LS	A40	B6	0,8	L87
SPIDER	2.0 V6	Mot. 471	164/223	01.1988		C 82 LS	A40	B6	0,8	L87

MAZDA

2	1.25	FUJA	55/75	04.2003		RC 62 HJSP	A181	B53	1,3	
	1.4	FXJA	59/80	04.2003		RC 62 HJSP	A181	B53	1,3	
	1.6	FYJA	74/101	04.2003		RC 62 HJS6	A182	B57	0,9	
121	1.1	B1	40/54	11.1990		RC 52 LS	A9	B20	0,9	L65
	1.1 Revue	B1	38-41/52-56	10.1987	10.1990	RC 52 LS	A9	B20	0,9	L65
	1.1 Revue	B116 Cat	38-41/52-56	04.1989	10.1990	RC 52 LS5	A36	B38	0,9	L65-5
	1.25	DHF/DHG	55/75	03.1996		RC 62 HJSP	A181	B53	1,3	
	1.25 i 16V	DHA Zetec [DOHC]	55/75	01.1996		RC 62 HJS6	A182	B57	0,9	
	1.3	B3	44/60	10.1987	10.1990	RC 52 LS5	A36	B38	0,9	L65-5
	1.3	B3	40/54	04.1989	10.1990	RC 52 LS5	A36	B38	0,9	L65-5
	1.3 i	J4C Endura-E	44/60		12.1999	RC 52 LJS5	A74	B56	0,9	
	1.3 i 16V	BJ [DOHC]	65/88	11.1990		RFC 52 LS5	A26	B24	0,9	F54-5
	1.3 Revue	B3 [SOHC]	40-44/54-60	10.1987	10.1990	RC 52 LS	A9	B20	0,9	L65
	1.5 i Revue	B5-MI Cat		01.1991		RFC 52 LS5	A26	B24	0,9	F54-5
	1.6 i	B6 Cat	63/86	01.1987	12.1991	RC 62 LS5	A24		0,9	L65-5
	1.8	VC		10.1975	12.1979	C 52 LS	A1	B1	0,9	L65

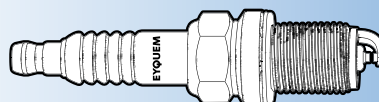

(1) Available until end of stock

- (a) 30 000 km
- (b) 60 000 km
- (c) Grey sticker on ignition coil
- (d) Green sticker on ignition coil

- (e) Hex 21 mm
- (f) Hex 16 mm
- (g) Recommended for cold weather



KW/HP



Box
10

Blister
4



F3→1

MAZDA

	2.0	MA	66/90	03.1977	12.1979	RC 52 LS	A9	B20	0,9	L65
323	1.6 i 16V	B6 [DOHC] Cat	80/109	08.1985	04.1990	RFC 58 LS5	A38	B48	0,9	F54-5
616	1.6 SNA	NA				C 62 LS	A4	B5	0,8	L65
929	2.0 Coupé, LX	M - FE - HE	66-81/90-110	10.1977	09.1986	RC 52 LS	A9	B20	0,8	L65
	2.0 i GLX, Coupé	FE - FA - FEB [OHC]	85-89/115-121	01.1984		RC 62 LS	A6	B17	0,8	L65
	2.0 Station Wagon	HEA - HEE - HE7	61-74/83-100	12.1981	09.1983	RC 52 LS	A9	B20	0,8	L65
	2.0 V6	JF	81/110	01.1986	06.1989	RFC 52 LS5	A26	B24	1,1	F54-5
	2.0 V6 Turbo	JF	107/145	01.1986	06.1989	RC 62 LS	A6	B17	0,8	L65
	2.2 12V	F21	85/115	12.1986	05.1989	RFC 52 LS5	A26	B24	1,1	F54-5
	2.2 12V	F2 /F21/F2E	85/115	01.1988	04.1989	RFC 58 LZ5E5	A75		0,9	F54-5
	2.2 12V	F2-C	94/128	04.1989	06.1991	RFC 58 LZ5E5	A75		0,9	F54-5
	2.2 i	F2-EGI	100/136	05.1987	12.1988	RFC 42 LS	A25		0,9	F54
	2.2 i 12V	F2E	100/136	12.1986	06.1989	RFC 52 LS	A3	B16	0,8	F54
	3.0	JE	140/190	06.1987	06.1989	RFC 42 LS	A25		0,9	F54
	3.0	JE3	125/170	01.1988	12.1989	RFC 58 LZ5E5	A75		0,9	F54-5
	3.0	JE3	123/167	01.1990	06.1991	RFC 58 LZ5E5	A75		0,9	F54-5
	3.0 i V6 18V	JE3	140/190	12.1986	06.1989	RFC 52 LS	A3	B16	0,8	F54
2 - LAPUTA	1.25 i 16V	F8JB - FUJA Cat	55/75			RC 62 HJS6	A182	B57	1,3	
	1.4 i 16V	FXJA - FXJB [DOHC] Cat	59/80			RC 62 HJS6	A182	B57	1,3	
	1.6	FYJA	74/101	04.2003		RC 62 HJSP	A181	B53	1,3	
	1.6 i 16V	FYJA [DOHC] Cat	74/101			RC 62 HJS6	A182	B57	1,3	
3	1.4	FXJA	59/80	02.2004	06.2009	RC 62 HJS6	A182	B57	1,3	
	1.4	ZJ-VE	62/84	10.2003	06.2009	RFC 42 LS5	A83		0,9	F54-5
	1.6	B6ZE	77/105	10.2003	06.2009	RFC 42 LS5	A83		0,9	F54-5
	2.0	LF17	110/150	10.2003		RN 62 LJZEDP6	A505		1,3	
3 II	1.6 MZR	Z6	77/105	06.2009		RFC 42 LS5	A83		0,9	F54-5
323 - 323 C	1.6 16V Hatchback	B6 - BG1	64/87	06.1989	07.1994	RFC 52 LS	A3	B16	0,9	F54
	1.6 16V Hatchback	B6 - B62 Cat	64/87	06.1989	07.1994	RFC 52 LS5	A26	B24	0,9	F54-5
	1.6 i Hatchback	B61T Cat	62/84	06.1989	03.1991	RC 52 LS5	A36	B38	0,9	L65-5
	1.8 i 16V 4WD, Hatchback	BP52	69/94	11.1989	05.1994	RFC 58 LS5	A38	B48	0,9	F54-5
	1.8 i 16V Coupé, Hatchback, GT	BP [DOHC] Cat	96/131	03.1991	07.1994	RFC 58 LS5	A38	B48	0,9	F54-5
	1.8 i 16V GT	BP [DOHC] Cat	103/140	06.1989	07.1994	RFC 58 LS	A18		0,9	F54
	1.8 i 16V Hatchback	BP [SOHC] Cat	76-78/103-106	03.1991	07.1994	RFC 58 LS5	A38	B48	0,9	F54-5
323 - 323 C - 323 P	1.8 i 16V Hatchback	BP [DOHC] Cat	84-99/114-135	08.1994		RFC 58 LS5	A38	B48	0,9	F54-5
323 - 323 C - 323 P - FAMILIA	1.3 i 16V Hatchback	B3 [SOHC] Cat	54-55/73-75	06.1994		RFC 52 LS5	A26	B24	1,1	F54-5
323 - 323 S	1.5 i 16V	B5 [DOHC]	89/121	02.1989	06.1994	RFC 58 LS5	A38	B48	0,9	F54-5
	1.5 i 16V	Z5 [DOHC]	65-71/88-97	06.1994		RFC 52 LS5	A26	B24	0,9	F54-5
	1.5 i 16V	Z5-DE [DOHC]	81/110	06.1994	05.1999	RFC 52 LS5	A26	B24	0,9	F54-5
	1.5 i 16V	B5-ZE [DOHC]	85/115	06.1994	10.1996	RFC 52 LS5	A26	B24	0,9	F54-5
	1.6 i 16V	B6 [DOHC] Cat	80/109	02.1989	01.1996	RFC 58 LS5	A38	B48	0,9	F54-5
	1.6 i 16V	B6-DE [DOHC]	85/115	10.1994	06.1998	RFC 52 LS5	A26	B24	0,9	F54-5
	1.8 i 16V	BP-ZE [DOHC] Cat	103/140	06.1996	06.1998	RFC 52 LS5	A26	B24	0,9	F54-5
	1.8 i 16V	FP-DE [DOHC]	85/115	06.1998		RFC 52 LS5	A26	B24	0,9	F54-5
	1.8 i 16V 4WD, Hatchback	BPC Cat	76-78/103-106	11.1989	05.1994	RFC 58 LS5	A38	B48	0,9	F54-5
	1.8 i 16V Turbo 4WD	BP [DOHC] Cat	132-139/180-189	11.1989	07.1994	RFC 58 LS5	A38	B48	0,9	F54-5
323 - FAMILIA	1.0	P	33-35-40/45-48-54	01.1976	08.1980	RC 62 LS	A6	B17	0,8	L65
	1.1	E1	40-41/54-56	07.1982	08.1989	RC 52 LS	A9	B20	0,8	L65
	1.3	T	44/60	01.1976	08.1980	RC 62 LS	A6	B17	0,8	L65
	1.3	D3	44/60	11.1980	10.1985	RC 52 LS	A9	B20	0,8	L65
	1.3	E3	44-55/60-75	11.1980	10.1985	RC 52 LS	A9	B20	0,8	L65
	1.3	B3 [SOHC]	44-50/60-68	05.1985	05.1989	RC 52 LS	A9	B20	0,8	L65
	1.3 Combi	D3 - E3	44-55/60-75	11.1980	10.1985	RC 52 LS	A9	B20	0,8	L65
	1.3 i	B3 - B383 [SOHC] Cat	49-50/67-98	04.1987	03.1991	RC 52 LS5	A36	B38	1,1	L65-5
	1.3 i 16V	B3 [SOHC] Cat	54/73	02.1989	10.1996	RFC 52 LS5	A26	B24	1,1	F54-5
	1.3 i 16V	B38 Cat	55-58/75-79	06.1989	03.1991	RFC 52 LS	A3	B16	0,8	F54
	1.3 i 16V	B3E	49-54/67-73	09.1989		RFC 52 LS5	A26	B24	1,1	F54-5
	1.3 i 16V	B3F Cat	54-55-58/73-75-79	03.1991	08.1992	RFC 52 LS5	A26	B24	1,1	F54-5
	1.3 i 16V	B3-ME [SOHC]	54-63/73-85	10.1996	05.1999	RFC 52 LS5	A26	B24	1,1	F54-5
	1.3 i 16V	B3 [SOHC] Cat	54/73	10.1996		RFC 52 LS5	A26	B24	1,1	F54-5
	1.3 Wagon	E3	44-50/60-68	01.1986		RC 52 LS	A9	B20	0,8	L65
	1.4	U	51/69	03.1978	05.1980	RC 52 LS	A9	B20	0,8	L65
	1.4 i LX	B6	44/60	09.1987	08.1989	RC 62 LS	A6	B17	0,8	L65
	1.5	B5	54/73	11.1981	05.1989	RC 52 LS	A9	B20	0,8	L65
	1.5	E5 [OHC]	55/75	08.1985	04.1990	RC 52 LS	A9	B20	0,8	L65
	1.5 Combi	D5	52/71	11.1981	10.1985	RC 52 LS5	A36	B38	1,1	L65-5

(f) Available until end of stock

(a) 30 000 km

(b) 60 000 km

(c) Grey sticker on ignition coil

(d) Green sticker on ignition coil

(e) Hex 21 mm

(f) Hex 16 mm

(g) Recommended for cold weather

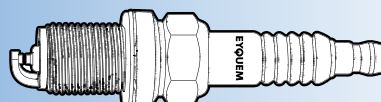

EYQUEM



Box
10

Blister
4



F3

MAZDA										
	1.5 i	B5	68/92	02.1987	02.1989	RC 52 LS5	A36	B38	1,1	L65-5
	1.5 i 16V	Z5 [DOHC]	65-81/88-110	05.1994		RFC 52 LS5	A26	B24	1,1	F54-5
	1.5 Wagon	B50 - B53 - B56 - B564	53-56/72-76	01.1986		RC 52 LS	A9	B20	0,8	L65
	1.6	B68	54/73	01.1986	06.1987	RC 52 LS5	A36	B38	1,1	L65-5
	1.6	B6	55/75	06.1986	07.1987	RFC 58 LS5	A38	B48	1,1	F54-5
	1.6 i	B6 Cat	63/86	07.1985	05.1989	RC 52 LS5	A36	B38	1,1	L65-5
	1.6 i	B6	77/105	07.1985	05.1989	RC 52 LS	A9	B20	0,8	L65
	1.6 i Turbo 4WD, GLX 4WD	B6 [DOHC]	110/150	06.1986	05.1989	RFC 58 LS	A18		0,9	F54
	1.6 i Wagon	B6 Cat	64/87	10.1986	08.1989	RC 52 LS5	A36	B38	1,1	L65-5
	1.6 i Wagon	B6	77/105	10.1986	08.1989	RC 52 LS	A9	B20	0,8	L65
	1.6 i Wagon	B6 Cat	64/87	09.1989	04.1990	RFC 52 LS5	A26	B24	1,1	F54-5
	1.6 i Wagon	B6	77/105	09.1989	09.1994	RFC 52 LS	A3	B16	0,8	F54
	1.6 i Wagon Van	B65 Cat	63-66/86-90	09.1992		RC 52 LS5	A36	B38	1,1	L65-5
	1.6 i Wagon, Wagon 4WD	B65L - B65M Cat	63-66/86-90	09.1989		RC 52 LS5	A36	B38	1,1	L65-5
	2.0 i V6 24V	KF [DOHC] Cat	106-108/144-147	05.1994		RFC 58 LS5	A38	B48	1,1	F54-5
323 CV	1.3 16V	B3 (16V)	54/73	08.1994	09.1998	RFC 42 LS5	A83		0,9	F54-5
	1.5 16V	Z5-DE	65/88	08.1994	09.1998	RFC 42 LS5	A83		0,9	F54-5
	1.8 16V	BP-ZE	84/114	08.1994	09.1998	RFC 42 LS5	A83		0,9	F54-5
323 F	1.8 i 16V	BP [DOHC] Cat	84-99/114-135	08.1994		RFC 58 LS5	A38	B48	0,9	F54-5
323 F - FAMILIA	1.6 i 16V	B6E Cat	65/88	08.1991	08.1994	RFC 52 LS5	A26	B24	1,1	F54-5
323 FVI	1.4	B3 (16V)	53/72	01.2001		RFC 42 LS5	A83		0,9	F54-5
	1.4 16V	B3 ME	54/73	09.1998	01.2001	RFC 52 LS5	A26	B24	0,9	F54-5
	1.6		72/98	01.2001		RFC 58 LZE5	A75		0,9	F54-5
	1.6		70/95	01.2001		RFC 58 LZE5	A75		0,9	F54-5
	1.9 16V		84/114	09.1998	01.2001	RFC 42 LS5	A83		0,9	F54-5
323 PV	1.5 16V	Z5-DE	65/88	10.1996		RFC 42 LS5	A83		0,9	F54-5
323 S IV	1.8 16V	BP52	76/103	08.1989	07.1994	RFC 42 LS5	A83		0,9	F54-5
323 SV	1.3 16V	B3 (16V)	54/73	08.1994	09.1998	RFC 42 LS5	A83		0,9	F54-5
	1.5 16V	Z5-DE	65/88	08.1994	09.1998	RFC 42 LS5	A83		0,9	F54-5
	1.8 16V	BP-ZE	84/114	08.1994	09.1998	RFC 42 LS5	A83		0,9	F54-5
323 SVI	1.4	B3 (16V)	53/72	01.2001		RFC 42 LS5	A83		0,9	F54-5
	1.4 16V	B3 ME	54/73	09.1998	01.2001	RFC 52 LS5	A26	B24	0,9	F54-5
	1.5 16V		65/88	09.1998	01.2001	RFC 42 LS5	A83		0,9	F54-5
	1.6		70/95	01.2001	09.2003	RFC 58 LZE5	A75		0,9	F54-5
	1.6		72/98	01.2001	09.2003	RFC 58 LZE5	A75		0,9	F54-5
	1.9 16V		84/114	09.1998		RFC 52 LS5	A26	B24	0,9	F54-5
6	2.0	LF18/LF17	104/141	06.2002		RN 62 LJZEDP6	A505		1,3	
	2.3	L3C1	122/166	06.2002		RN 62 LJZEDP6	A505		1,3	
6 Hatchback	2.0	LF18/LF17	104/141	08.2002		RN 62 LJZEDP6	A505		1,3	
	2.3	L3C1	122/166	08.2002		RN 62 LJZEDP6	A505		1,3	
6 Station Wagon	2.0	LF18/LF17	104/141	08.2002		RN 62 LJZEDP6	A505		1,3	
	2.3	L3C1	122/166	08.2002		RN 62 LJZEDP6	A505		1,3	
	2.3 AWD	L3C1	119/162	11.2002		RN 62 LJZEDP6	A505		1,3	
626 - CAPELLA	1.3 STC, STCV	TC		01.1971	12.1977	C 62 LS	A4	B5	0,8	L65
	1.6	H6 - N	55/75	10.1978	12.1982	RC 52 LS	A9	B20	0,8	L65
	1.6	B6	55/75	07.1987	10.1991	RFC 58 LS5	A38	B48	1,1	F54-5
	1.6 3A, AV, SN	NA		01.1973	12.1979	C 62 LS	A4	B5	0,8	L65
	1.6 Coupé	F6 - F68	54-66/74-90	11.1982	07.1991	RC 52 LS	A9	B20	0,8	L65
	1.6 i	B6 Cat	63/86	02.1987	04.1997	RC 52 LS5	A36	B38	1,1	L65-5
	1.8	H8 - V - F8	73-74/99-100	10.1978	08.1985	RC 52 LS	A9	B20	0,8	L65
	1.8	F8 [OHC]	65-66/88-90	07.1987	08.1989	RFC 58 LZE5	A75		1,1	F54-5
	1.8 i	F8	65-66/88-90	09.1989	03.1992	RFC 58 LS5	A38	B48	1,1	F54-5
	1.8 i 16V	F8-DE [DOHC]	85/115	06.1989		RFC 58 LS5	A38	B48	1,1	F54-5
	1.8 i 16V	FP [DOHC]	77/105	05.1997		RFC 32 LZ5	A117		1,1	
	1.8 i 16V Hatchback	FP [DOHC]	66-77/90-105	08.1991		RFC 52 LS5	A26	B24	1,1	F54-5
	1.8 i Wagon	F8	65/88	06.1989	11.1997	RFC 58 LS5	A38	B48	1,1	F54-5
	1.8 Station Wagon	F8	65/88	10.1989	07.1991	RFC 52 LS	A3	B16	0,9	F54
	1.8 Wagon	F8 [OHC]	65-66/88-90	07.1987	08.1989	RFC 58 LZE5	A75		1,1	F54-5
	2.0	H3 - HE3 - M	66/90		10.1982	RC 52 LS	A9	B20	0,8	L65
	2.0	FE [OHC]	74-88/100-120	11.1982	06.1987	RC 52 LS5	A36	B38	1,1	L65-5
	2.0	FE [OHC]	79-80/107-109	11.1982	06.1987	RFC 58 LS	A18		0,8	F54
	2.0	FE Cat	68/92	07.1985	06.1987	RC 52 LS5	A36	B38	1,1	L65-5
	2.0	FEA [OHC] Cat	66/90	07.1987	08.1989	RC 52 LS5	A36	B38	1,1	L65-5
	2.0	FE	66/90	09.1987	10.1990	C 62 LS	A4	B5	0,8	L65
	2.0 i	FE [OHC] Cat	66/90	06.1987	07.1991	RC 52 LS5	A36	B38	1,1	L65-5



(1) Available until end of stock

- (a) 30 000 km
- (b) 60 000 km
- (c) Grey sticker on ignition coil
- (d) Green sticker on ignition coil

- (e) Hex 21 mm
- (f) Hex 16 mm
- (g) Recommended for cold weather



KW/HP



Box
10

Blister
4



F3-D1

MAZDA

	2.0 i	FE [OHC]	79-80/107-109	06.1987	09.1989	RFC 58 LS	A18		0,8	F54
	2.0 i 12V Wagon	FE [OHC]	80-81/109-110	01.1988	08.1989	RC 62 LS	A6	B17	0,8	L65
	2.0 i 12V Wagon	FE [OHC]	80-81/109-110	09.1989	03.1992	RFC 58 LS	A18		0,8	F54
	2.0 i 16V	FE [DOHC] Cat	103/140	07.1987	03.1992	RFC 58 LS5	A38	B48	1,1	F54-5
	2.0 i 16V GLX 4WD, Hatchback	FS [DOHC] Cat	85/115	08.1991		RFC 58 LS5	A38	B48	1,1	F54-5
	2.0 i 16V Wagon	FE [DOHC]	109/148	06.1987	03.1992	RFC 58 LS	A18		0,8	F54
	2.0 i 16V Wagon	FEKG [DOHC] Cat	103/140	01.1988		RFC 58 LS5	A38	B48	1,1	F54-5
	2.0 i GLX, GTI	FE [OHC] Cat	68/92	07.1985	06.1987	RC 52 LS	A9	B20	0,8	L65
	2.0 i GLX, GTI	FE [OHC]	88/120	07.1985	06.1987	RC 62 LS	A6	B17	0,8	L65
	2.0 i Wagon	FE [OHC] Cat	66/90	06.1987		RC 52 LS5	A36	B38	1,1	L65-5
	2.0 i Wagon	FEKF [OHC] Cat	66/90	01.1988		RC 62 LS	A6	B17	0,8	L65
	2.0 Station Wagon	FE	66/90	10.1988	09.1997	C 62 LS	A4	B5	0,8	L65
	2.0 Wagon	FE [OHC]	75/102	01.1988	08.1989	RC 62 LS	A6	B17	0,8	L65
	2.0 Wagon	FE [OHC]	75/102	09.1989	03.1992	RFC 58 LS	A18		0,8	F54
	2.2 12V	F2	85/115	11.1987	07.1991	RFC 58 LZE5	A75		1,1	F54-5
	2.2 12V Hatchback	F2	85/115	06.1988	04.1992	RFC 58 LZE5	A75		1,1	F54-5
	2.2 12V, 4WD Station Wagon	F2	85/115	03.1989	11.1996	RFC 58 LZE5	A75		1,1	F54-5
	2.2 12V,Coupé	F2	85/115	04.1988	12.1991	RFC 58 LZE5	A75		1,1	F54-5
	2.2 i 12V 4WD	F2 [OHC] Cat	85/115	11.1987	01.1993	RFC 32 LZ5	A117		1,1	
	2.2 i 12V Wagon	F2 [OHC] Cat	85/115	11.1987	01.1993	RFC 32 LZ5	A117		1,1	
	2.5 24V Hatchback	KL	121/165	01.1992	04.1997	RFC 58 LZE5	A75		1,1	F54-5
	2.5 24V Hatchback	KL	120/163	08.1994	04.1997	RFC 58 LZE5	A75		1,1	F54-5
	2.5 i 24V	KL [DOHC] Cat	121-123/165-167	09.1991		RFC 32 LZ5	A117		1,1	
	2.5 V6 ES-R, ES-RS, ES-X					RFC 32 LZ5	A117		1,1	
626 V	1.8, Hatchback (GF)		66/90	05.1997	12.1999	RFC 42 LZDP	A188		0,8	
	1.9, (GF)		66/90	05.1997	12.1999	RFC 42 LZDP	A188		0,8	
	1.9, (GF)	FP9A	74/101	12.1999		RFC 42 LZDP	A188		0,8	
	1.9, Hatchback (GF)		74/101	12.1999		RFC 42 LZDP	A188		0,8	
	1.9, Station Wagon (GW)		66/90	02.1998	01.2000	RFC 42 LZDP	A188		0,8	
	1.9, Station Wagon (GW)	FP9A	74/101	01.2000		RFC 42 LZDP	A188		0,8	
	2.0, (GF)	FS	85/115	05.1997		RFC 42 LZDP	A188		0,8	
	2.0, (GF)	FS2C	100/136	04.1998		RFC 42 LZDP	A188		0,8	
	2.0, Hatchback (GF)	FS	85/115	05.1997		RFC 42 LZDP	A188		0,8	
	2.0, Station Wagon (GW)	FS	85/115	02.1998		RFC 42 LZDP	A188		0,8	
	2.0 H.P, Hatchback (GF)	FS2C	100/136	02.1998		RFC 42 LZDP	A188		0,8	
	2.0 H.P, Station Wagon (GW)	FS2C	100/136	02.1998		RFC 42 LZDP	A188		0,8	
929 L	1.8	V	74/101	01.1974	08.1978	RC 62 LS	A6	B17	0,8	L65
	2.0 Combi	M	64-81/87-110	10.1977	12.1981	RC 52 LS	A9	B20	0,8	L65
AZ	1.8 i V6 24V	K8 [DOHC] Cat	95/129	09.1993	01.1998	RFC 52 LS5	A26	B24	1,1	F54-5
	660 i	F6-A [SOHC]	47/64	09.1994	10.1998	RC 52 LS	A9	B20	0,8	L65
BONGO	1.4	UC [SOHC]	47/64	07.1990	07.1990	RC 52 LS	A9	B20	0,8	L65
	1.5	D5	52/71	07.1990	09.1995	RC 52 LS5	A36	B38	1,1	L65-5
	1.8	F8 [OHC]	65/88	06.1983	07.1990	RFC 58 LZE5	A75		1,1	F54-5
	1.8 i	F8	65/88	07.1990	06.1999	RFC 58 LS5	A38	B48	1,1	F54-5
	2.0	FE [OHC]		06.1983	08.1990	RC 52 LS5	A36	B38	1,1	L65-5
	2.0 i	FE [OHC] Cat	66/90	08.1990	06.1999	RC 52 LS5	A36	B38	1,1	L65-5
BONGO FRIENDEE	2.0 i 12V	FE-E [SOHC]	77/105	06.1995		RFC 52 LS5	A26	B24	1,1	F54-5
	2.5 i V6 24V	J5-DE [DOHC]	118/160	06.1995		RFC 52 LS5	A26	B24	1,1	F54-5
B-SERIE	2.6 12V	G6 [SOHC] Cat	90/122	03.1996		RFC 32 LZ5	A117		1,1	
	2.6 12V 4WD	JK26	90/122	06.1999		RFC 58 LZE5	A75		0,9	F54-5
	B 2000 : 2.0 i V6					RC 62 LS	A6	B17	0,8	L65
	B 2200 : 2.2	F2 Cat		03.1996		RC 52 LS5	A36	B38	1,1	L65-5
	B 2600 : 2.6 i V6	JK 26	90/122			RC 62 LS	A6	B17	0,8	L65
CAROL	660 i	F6-A [SOHC]		01.1991	10.1995	RC 52 LS	A9	B20	0,9	L65
COSMO	2.0	FE Cat	68/92	10.1983	10.1990	RC 52 LS5	A36	B38	1,1	L65-5
CRONOS	1.8 i V6 24V	K8-ZE [DOHC] Cat	104/141	10.1991	01.1996	RFC 52 LS5	A26	B24	1,1	F54-5
	2.0 i 16V	FS-DE [SOHC] Cat	85/115	10.1991	01.1996	RFC 52 LS5	A26	B24	1,1	F54-5
	2.0 i V6 24V	KF-ZE [DOHC] Cat	116/160	10.1991	01.1996	RFC 58 LS5	A38	B48	1,1	F54-5
	2.5 i V6 24V	KL-ZE [DOHC] Cat	127-148/172-200	05.1992	01.1996	RFC 58 LS5	A38	B48	1,1	F54-5
D	1.5	UA				RC 82 LS	A78		0,8	L87
DEMIO	1.3 i 16V	B3 [SOHC] Cat	46-53/63-72	09.1996		RFC 52 LS5	A26	B24	1,1	F54-5
	1.3 i 16V	B3-ME [SOHC]	61/83	08.1996	12.1997	RFC 52 LS5	A26	B24	1,1	F54-5
	1.3 i 16V	B3E	49/67	12.1999		RFC 52 LS5	A26	B24	1,1	F54-5
	1.5 i 16V	B5-ME [SOHC]	73/99	08.1996	12.1997	RFC 52 LS5	A26	B24	1,1	F54-5
E	1.3	TC		01.1975	08.1980	C 62 LS	A4	B5	0,8	L65

(f) Available until end of stock

(a) 30 000 km

(b) 60 000 km

(c) Grey sticker on ignition coil

(d) Green sticker on ignition coil

(e) Hex 21 mm

(f) Hex 16 mm

(g) Recommended for cold weather



EYQUEM



Box
10

Blister
4



F3 → 1

MAZDA										
	1.3	TC		09.1980	12.1983	RC 82 LS	A78		0,8	L87
	1.4	D417				RC 52 LS	A9	B20	0,8	L65
	1.6	NA		08.1977	09.1980	C 62 LS	A4	B5	0,8	L65
	1.6	NA		09.1980	12.1983	RC 52 LS	A9	B20	0,8	L65
	1.8	F85				RC 52 LS	A9	B20	0,8	L65
	2.0 i	FEJL				RFC 58 LS5	A38	B48	1,1	F54-5
	2000 : 2.0	FE18	63/86	11.1984	04.1989	RC 52 LS	A9	B20	0,8	L65
	2000 : 2.0	FE58	63/86	05.1985	04.1989	RC 52 LS	A9	B20	0,8	L65
	2000 : 2.0	FE60 - FE61	60/82	03.1991	05.1994	RC 52 LS	A9	B20	0,8	L65
	2000 : 2.0	FEBM - FEBM - FECL - FEEN - FEET - FES3				RC 52 LS	A9	B20	0,8	L65
	2000 : 2.0	FE [OHC]				RC 52 LS5	A36	B38	1,1	L65-5
	2000 : 2.0	FEE				RFC 52 LS5	A26	B24	1,1	F54-5
	2000 : 2.0 4x4	FEV4	63/86	11.1984	02.1988	RC 52 LS	A9	B20	0,8	L65
	2000 : 2.0 4x4	FEBN	60/82	10.1988	09.1989	RC 52 LS	A9	B20	0,8	L65
ETUDE	1.5	B5	54/73	02.1988	08.1990	RFC 52 LS5	A26	B24	1,1	F54-5
	1.6 i 16V	B6 [DOHC] Cat	80/109	01.1987	08.1990	RFC 58 LS5	A38	B48	1,1	F54-5
EUNOS	1.5 i 16V	B5-ZE [DOHC]	85/115	09.1993	01.1998	RFC 52 LS5	A26	B24	1,1	F54-5
	1.6 i 16V	B6-ZE [DOHC]	87/118	09.1989	01.1998	RFC 52 LS5	A26	B24	1,1	F54-5
	1.8 i 16V	BP-ZE [DOHC] Cat	103/140	09.1993	01.1998	RFC 52 LS5	A26	B24	1,1	F54-5
	1.8 i V6 24V	K8-ZE [DOHC] Cat	95-104/-129140	06.1991	01.1998	RFC 52 LS5	A26	B24	1,1	F54-5
EUNOS 100	1.8 i 16V	BP-ZE [DOHC] Cat	103/140	11.1989	06.1994	RFC 52 LS5	A26	B24	1,1	F54-5
EUNOS 300	1.8 i 16V	F8-DE [DOHC]	85/115	11.1989	01.1992	RFC 58 LS5	A38	B48	1,1	F54-5
	2.0 i 16V	FE-ZE [DOHC] Cat	110/150	11.1989	01.1992	RFC 58 LS5	A38	B48	1,1	F54-5
EUNOS 500	1.8 i 16V	BP-ZE [DOHC] Cat	103/140	03.1994	12.1995	RFC 52 LS5	A26	B24	1,1	F54-5
	1.8 i 16V	FP [DOHC]	77/105	03.1994	12.1995	RFC 32 LZ5	A117		1,1	
	1.8 i V6 24V	K8-ZE [DOHC] Cat	104/141	02.1992	12.1995	RFC 52 LS5	A26	B24	1,1	F54-5
	2.0 i V6 24V	KF-ZE [DOHC] Cat	116/160	02.1992	12.1995	RFC 58 LS5	A38	B48	1,1	F54-5
EUNOS 800 MILLENNIA	2.0 i V6 24V	KF-ZE [DOHC] Cat	116/160	07.1998		RFC 58 LS5	A38	B48	1,1	F54-5
	2.5 i V6 24V	KL-ZE [DOHC] Cat	127-148/172-200	10.1993		RFC 58 LS5	A38	B48	1,1	F54-5
EUNOS CARGO	1.5	D5	52/71	09.1990		RC 52 LS5	A36	B38	1,1	L65-5
	2.0	FE Cat	68/92	09.1990		RC 52 LS5	A36	B38	1,1	L65-5
FESTIVA	1.1 i	B1	38/52	02.1985	01.1993	RC 52 LS	A9	B20	0,9	L65
	1.3	B3 [SOHC]	51/69	02.1985		RC 52 LS	A9	B20	0,9	L65
	1.3 i	B3 [SOHC] Cat	49/67	03.1989	05.1994	RC 52 LS5	A36	B38	1,1	L65-5
	1.3 i	B3-MI [SOHC]	56/76	01.1993		RFC 52 LS5	A26	B24	1,1	F54-5
	1.3 i 16V	BJ [DOHC]	65/88	10.1986	01.1993	RFC 52 LS5	A26	B24	1,1	F54-5
	1.3 i 16V	B3 [SOHC] Cat	54/73	01.2000		RFC 52 LS5	A26	B24	1,1	F54-5
	1.3 i 16V	B3-ME [SOHC]	61/83			RFC 52 LS5	A26	B24	1,1	F54-5
	1.5 i	B5	68/92	01.2000		RFC 52 LS5	A26	B24	1,1	F54-5
	1.5 i 16V	B5-ME [SOHC]	74/101	01.1993		RFC 52 LS5	A26	B24	1,1	F54-5
LANTIS	1.5 i 16V	Z5-DE [DOHC]	65/88	09.1993		RFC 52 LS5	A26	B24	1,1	F54-5
	1.6 i 16V	B6-DE [DOHC]	85/115	09.1993		RFC 52 LS5	A26	B24	1,1	F54-5
	1.8 i 16V	BP-ZE [DOHC] Cat	103/140	09.1993	09.1997	RFC 52 LS5	A26	B24	1,1	F54-5
	2.0 i V6 24V	KF-ZE [DOHC] Cat	116/160	09.1993	09.1997	RFC 58 LS5	A38	B48	1,1	F54-5
LUCE	2.0	FE Cat	68/92	09.1983	05.1990	RC 52 LS5	A36	B38	1,1	L65-5
	2.0 V6	JF	81/110	09.1988	03.1992	RFC 52 LS5	A26	B24	1,1	F54-5
	2.0 V6	JF Cat	81/110	09.1988	03.1992	RFC 58 LS5	A38	B48	1,1	F54-5
	2.2	F2 Cat		03.1992	01.1996	RC 52 LS5	A36	B38	1,1	L65-5
	3.0 i V6 18V	JE [SOHC] Cat	113/154			RFC 58 LZE5	A75		1,1	F54-5
M2	1.6 i 16V	B6 [DOHC] Cat	80/109	03.1992		RFC 58 LS5	A38	B48	1,1	F54-5
MPV	3.0 i V6 18V	JE [SOHC] Cat	113/154	07.1994	10.1995	RFC 58 LZE5	A75		1,1	F54-5
	3.0 i V6 18V	JE-E [SOHC] Cat	109-113/148-154	10.1995	06.1999	RFC 32 LZ5	A117		1,1	
MPV I	3.0 i V6		109/148	05.1996	09.1999	RFC 52 LS5	A26	B24	0,9	F54-5
MPV II	2.0	FS-DS	90/122	09.1999	08.2000	RFC 58 LZE5	A75		0,9	F54-5
MS 6	1.8 i V6 24V	K8-ZE [DOHC] Cat	104/141	11.1991	07.1994	RFC 52 LS5	A26	B24	1,1	F54-5
	2.0 i 16V	FS-DE [DOHC] Cat	92/125	11.1991	07.1994	RFC 52 LS5	A26	B24	1,1	F54-5
	2.0 i V6 24V	KF-ZE [DOHC] Cat	116/160	11.1991	07.1994	RFC 58 LS5	A38	B48	1,1	F54-5
MX-3	1.6 i	B69	65/88	07.1991	10.1993	RFC 42 LS5	A83		0,9	F54-5
	1.6 i 16V	B69 - B6D Cat	66-80/90-109	05.1991		RFC 52 LS5	A26	B24	1,1	F54-5
	1.6 i 16V	B6 [DOHC] Cat	80/109	05.1991		RFC 58 LS5	A38	B48	1,1	F54-5
	1.8 i V6	K819	98/133	01.1992	01.1994	RFC 42 LS5	A83		0,9	F54-5
	1.8 i V6 24V	K8 [DOHC] Cat	95-100/129-136	05.1991		RFC 52 LS5	A26	B24	1,1	F54-5
MX-5	1.6 i 16V		81/110	05.1998		RFC 42 LS5	A83		0,9	F54-5
	1.6 i 16V	B64F [DOHC] Cat	85/115	09.1989	08.1993	RFC 52 LS5	A26	B24	1,1	F54-5

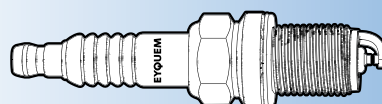

- (1) Available until end of stock
 (a) 30 000 km
 (b) 60 000 km
 (c) Grey sticker on ignition coil
 (d) Green sticker on ignition coil

- (e) Hex 21 mm
 (f) Hex 16 mm
 (g) Recommended for cold weather



KW/HP



Box
10

Blister
4



F3-D1

MAZDA

	1.6 i 16V	B6-ZE [DOHC]	87/118	01.1990		RFC 52 LS5	A26	B24	1,1	F54-5
	1.6 i 16V	[DOHC] Cat	66/90	12.1994	11.1997	RFC 58 LS5	A38	B48	1,1	F54-5
	1.8 16V	BP-ZE	103/140	05.1998		RFC 42 LS5	A83		0,9	F54-5
	1.8 i 16V	BP-ZE - BPF1 [DOHC] Cat	96-103/131-140	09.1993	11.1997	RFC 52 LS5	A26	B24	1,1	F54-5
	1.8 16V	BPD	102/139	11.2000		RFC 42 LS5	A83		0,9	F54-5
	1.8 16V	BPD	107/145	11.2000		RFC 42 LS5	A83		0,9	F54-5
MX-6	2.0	FS	85/115	02.1992		RFC 42 LS5	A83		0,9	F54-5
	2.0 i 16V	FS [DOHC] Cat	85/115	07.1991		RFC 58 LS5	A38	B48	1,1	F54-5
	2.0 i V6 24V	KF-ZE [DOHC] Cat	116/160	07.1991	01.1996	RFC 58 LS5	A38	B48	1,1	F54-5
	2.5 24V	KL	121/165	02.1992		RFC 58 LZ5E5	A75		0,9	F54-5
	2.5 i 24V	KL	120/163	08.1994		RFC 58 LZ5E5	A75		0,9	F54-5
	2.5 i 24V 4WS	KL [DOHC] Cat	121-123/165-167	07.1991		RFC 32 LZ5	A117		1,1	
	2.5 i V6 24V	KL-ZE [DOHC] Cat	127-148/172-200	07.1991	01.1996	RFC 58 LS5	A38	B48	1,1	F54-5
	2.5 V6 LS					RFC 32 LZ5	A117		1,1	
PERSONA	1.8	F8 [OHC]	65/88	08.1989	03.1992	RFC 58 LZ5E5	A75		1,1	F54-5
	2.0	FE [OHC]		10.1988	03.1992	RC 52 LS5	A36	B38	1,1	L65-5
PICK-UP B	1.0	PC		01.1969	08.1981	RC 52 LS	A9	B20	0,8	L65
	1.6 Pick-Up B	NA		01.1971	10.1987	RC 62 LS	A6	B17	0,8	L65
	1.8 Pick-Up B	VC		01.1975	10.1987	RC 62 LS	A6	B17	0,8	L65
PORTER	0.5	G23B	24/33	12.1982	11.1989	RC 62 LS	A6	B17	0,8	L65
PREMACY	1.8	FP	74/101	07.1999		RFC 42 LS5	A83		0,9	F54-5
	1.8 i 16V	FP [DOHC]	74-85/100-115	03.1999		RFC 32 LZ5	A117		1,1	
	1.9	FP	84/114	07.1999		RFC 42 LS5	A83		0,9	F54-5
	2.0	FS7E/FS7G	96/131	11.2001		RFC 58 LZ5E5	A75		0,9	F54-5
PROBE	2.2 i 12V	F2 [OHC] Cat	85/115	09.1988	09.1992	RFC 32 LZ5	A117		1,1	
	2.5 i 24V	KL [DOHC] Cat	123/167	09.1992		RFC 32 LZ5	A117		1,1	
PROCEED / MARVIE	2.6i 12V	G6 [SOHC] Cat	90/122	02.1990		RFC 32 LZ5	A117		1,1	
RAZOR	1.3	B3 [SOHC]	51/69	08.1985	06.1994	RC 52 LS	A9	B20	0,8	L65
	1.3 i	B3 [SOHC] Cat	49/67	04.1987	03.1991	RC 52 LS5	A36	B38	1,1	L65-5
	1.3 i 16V	B3 [SOHC] Cat	54/73	02.1989	12.1998	RFC 52 LS5	A26	B24	1,1	F54-5
	1.3 i 16V	B3E	49/67	12.1998		RFC 52 LS5	A26	B24	1,1	F54-5
	1.5	E5 [OHC]	55/75	10.1989	06.1994	RC 52 LS	A9	B20	0,8	L65
	1.5 i	B5	68/92	02.1987	02.1989	RFC 52 LS5	A26	B24	1,1	F54-5
	1.6 i 16V	B6 [DOHC] Cat	80/109	08.1985	03.1989	RFC 58 LS5	A38	B48	1,1	F54-5
	1.8 i 16V	BP-ZE [DOHC] Cat	103/140	06.1994	12.1998	RFC 52 LS5	A26	B24	1,1	F54-5
REVIEW	1.3 i	B3 [SOHC] Cat	49/67	09.1990		RC 52 LS5	A36	B38	1,1	L65-5
	1.5 i	B5	68/92	09.1990		RFC 52 LS5	A26	B24	1,1	F54-5
SENTIA	2.5 i V6 24V	J5-DE [DOHC]	118/160	05.1991	10.1995	RFC 52 LS5	A26	B24	1,1	F54-5
	3.0 i V6 18V	JE-E [SOHC] Cat	113/154	10.1995		RFC 32 LZ5	A117		1,1	
	3.0 i V6 24V	JE-ZE [DOHC] Cat	144/196	05.1991	10.1995	RFC 32 LZ5	A117		1,1	
SPECTRON / J80 / J100	1.5	D5	52/71	07.1990	09.1995	RC 52 LS5	A36	B38	1,1	L65-5
	1.8 i	F8	65/88	06.1983		RFC 58 LS5	A38	B48	1,1	F54-5
	2.0 i	FE [OHC] Cat	66/90	01.1984	09.1995	RC 52 LS5	A36	B38	1,1	L65-5
	2.0 i	FE [OHC]	85/115	01.1984	09.1995	RC 62 LS	A6	B17	0,8	L65
TELLSTAR	1.6 i	B6 Cat	55/75	05.1987	10.1991	RC 52 LS5	A36	B38	1,1	L65-5
	1.8	F8 [OHC]	65/88	05.1987	10.1991	RFC 58 LZ5E5	A75		1,1	F54-5
	1.8 i	F8	65/88	05.1987	10.1991	RC 52 LS	A9	B20	0,8	L65
	1.8 i	F8	65/88	11.1991		RFC 58 LS5	A38	B48	1,1	F54-5
	1.8 i 16V	FP-DE [DOHC]	85/115	08.1994		RFC 52 LS5	A26	B24	1,1	F54-5
	1.8 i V6 24V	K8-ZE [DOHC] Cat	104/141	10.1991	09.1994	RFC 52 LS5	A26	B24	1,1	F54-5
	2.0 i 16V	FE [DOHC] Cat	103/140		10.1991	RFC 58 LS5	A38	B48	1,1	F54-5
	2.0 i 16V	FS-DE [DOHC] Cat	92/125	02.1992	08.1994	RFC 52 LS5	A26	B24	1,1	F54-5
	2.0 i 16V	FE/FE-DE	94/128	08.1992	11.1997	RFC 58 LS5	A38	B48	1,1	F54-5
	2.0 i 16V	FS-ZE Cat		08.1997		RFC 32 LZ5	A117		1,1	
	2.0 i V6 24V	KF-ZE [DOHC] Cat	116/160	10.1991	01.1996	RFC 58 LS5	A38	B48	1,1	F54-5
	2.5 i V6 24V	KL-ZE [DOHC] Cat	127-148/172-200	08.1997		RFC 58 LS5	A38	B48	1,1	F54-5
TRANSPORTER		SR		01.1983		RC 62 LS	A6	B17	0,8	L65
TRIBUTE	2.0, 4WD		91/124	03.2000		RC 62 HJSP	A181	B53	1,3	
	3.0 V6 24V 4WD		145/197	03.2000		RC 72 LJS	A88		0,6	J87
XEDOS 6	1.6 16V	B69	83/113	08.1992	05.1994	RFC 42 LS5	A83		0,9	F54-5
	1.6 16V	B6	79/107	06.1994	04.1996	RFC 42 LS5	A83		0,9	F54-5
	1.6 i 16V	B6 Cat	79-85/107-115	01.1992		RFC 58 LS5	A38	B48	1,1	F54-5
	2.0 i 24V	KF1 [DOHC] Cat	103-105-108/ 140-143-147	01.1992		RFC 58 LS5	A38	B48	1,1	F54-5
XEDOS 9	2.0 i V6 24V	KF [DOHC] Cat	105-107/143-146	09.1993		RFC 58 LS5	A38	B48	1,1	F54-5

(f) Available until end of stock

(a) 30 000 km

(b) 60 000 km

(c) Grey sticker on ignition coil

(d) Green sticker on ignition coil

(e) Hex 21 mm

(f) Hex 16 mm

(g) Recommended for cold weather



EYQUEM



Box 10
Blister 4



F3 → 1

MAZDA									
	2.5 24V	KL	123/167	07.1993	07.2000	RFC 58 LZE5	A75	0,9	F54-5
	2.5 i 24V	KL [DOHC] Cat	123-125/167-170	07.1993		RFC 32 LZ5	A117	1,1	

MERCEDES									
170 (W170)	V	M 136.920	33/45	06.1946	05.1950	C 32	A33	0,6	
	S	M 136.922	38/52	05.1949	10.1956	C 32	A33	0,6	
190 (W201)	190 E 1.8 (201.018)	M 102.919 - M 102.910	77-80/105-109	04.1990	08.1993	C 62 LJS	A19	B2	0,8 J65
	190 2.0 i (201.022)	M 102.921 - M 102.924 Cat	66-77/90-105	10.1982	05.1990	C 62 LJS	A19	B2	0,8 J65
	190 2.0 i (201.023)	M 102.924	75-77/102-105	01.1986	05.1990	C 62 LJS	A19	B2	0,8 J65
	190 2.0 i (201.024)	M 102.962	85/116	02.1985	12.1986	C 62 LJS	A19	B2	0,8 J65
	190 2.0 i (201.024)	M 102.961 - M 102.962	87-90/118-122	10.1982	08.1993	C 62 LJS	A19	B2	0,8 J65
	190 E 2.3 i	M 102.985	97-100/132-136	09.1983	08.1993	C 62 LJS	A19	B2	0,8 J65
	190 E 2.3 i 16V	M 102.983 Cat	125/170	04.1984	12.1987	C 72 LJS	A22		0,8 J87
	190 E 2.3 i 16V	M 102.983	130/177	09.1985	08.1988	C 72 LJS	A22		0,8 J87
	190 E 2.3 i 16V (201.034)	M 102.983	136/185	04.1984	01.1987	C 82 LJS	A52		0,8 J87
	190 E 2.5 i 16V	M 102.991	143/194	09.1988	08.1993	C 62 LJS	A19	B2	0,8 J65
	190 E 2.5 i 16V	M 102.990	150/204	09.1988	08.1993	C 62 LJS	A19	B2	0,8 J65
	190 E Evolution II 2.5	M 102.992	173/235	05.1990	08.1993	C 62 LJS	A19	B2	0,8 J65
	190 E : 2.6 i V6 (201.029)	M 103.942	118-122/160-166	12.1982	08.1993	C 62 LJS	A19	B2	0,8 J65
8 (W114)	230.6 (114.015)	M 180.954	88/120	01.1968	12.1976	RC 62 LS	A6	B17	0,8 L65
	230.6 (114.015)	M 180.954	88/120	01.1968	12.1976	C 82 LS	A40	B6	0,8 L87
	250 (114.010)	M 114.920	85/116	01.1968	08.1972	RC 72 LS	A32	B26	0,8 L87
	250	M 114.920	96/130	07.1968	08.1972	RC 72 LS	A32	B26	0,8 L87
	250 2.8 (114.011)	M 130.923	96/130	06.1972	11.1976	RC 72 LS	A32	B26	0,8 L87
	280 (114.060)	M 110.921	118/160	06.1972	11.1976	RC 72 LS	A32	B26	0,8 L87
	280 E (114.062)	M 110.981	136/185	06.1972	11.1976	RC 72 LS	A32	B26	0,8 L87
8 (W115)	200 (115.015)	M 115.923 - M115.926	63/86	01.1968	01.1977	RC 72 LS	A32	B26	0,8 L87
	200	M 115.923 - M115.926	70/95	01.1968	01.1977	RC 72 LS	A32	B26	0,8 L87
	220 (115.010)	M 115.924	66/90	01.1968	07.1973	RC 72 LS	A32	B26	0,8 L87
	220 (115.010)	M 115.920	77/105	01.1968	07.1973	RC 72 LS	A32	B26	0,8 L87
	230.4 (115.017)	M 115.951	81/110	08.1976	12.1976	RC 72 LS	A32	B26	0,8 L87
Cabriolet (W111)	280 SE (111.025)	M 116.980	147/200	01.1969	12.1971	C 82 LS	A40	B6	0,8 L87
8 Coupé (W114)	250 C (114.021)	M 114.920	96/130	04.1969	06.1972	RC 72 LS	A32	B26	0,8 L87
	250 CE (114.022)	M 114.980	110/150	04.1969	04.1972	C 82 LS	A40	B6	0,8 L87
	250 C 2.8 (114.023)	M 130.923	96/130	06.1972	11.1976	RC 72 LS	A32	B26	0,8 L87
	280 C (114.073)	M 110.921	118/160	06.1972	02.1977	RC 72 LS	A32	B26	0,8 L87
	280 CE (114.072)	M 110.981	136/185	06.1972	01.1977	RC 72 LS	A32	B26	0,8 L87
Class A (W168)	A 140 (168.031, 168.131)	M 166.940	60/82	06.1997	08.2004	RFC 58 LZ3EX	A58	B55	0,9 F54
	A 140 (168.031, 168.131)	M 166.960	60/82	01.2001	08.2004	RFC 58 LZ3EX	A58	B55	0,9
	A 160 (168.033, 168.133)	M 166.960	75/102	06.1997	08.2004	RFC 58 LZ3EX	A58	B55	0,9 F54
	A 190 (168.032, 168.132)	M 166.990	92/125	06.1999	08.2004	RFC 58 LZ3EX	A58	B55	0,9 F54
	A 210 (168.035, 168.135)	M 166.995	103/140	03.2002	08.2004	RFC 58 LZ3EX	A58	B55	0,9 F54
Class A (W169)	NEW A 150 (169.031, 169.331)	M 266.920	70/95	09.2004	06.2012	FC 52 LZWR	A543		0,85
	NEW A 160 (169.031, 169.331)	M 266.920	70/95	04.2009	06.2012	FC 52 LZWR	A543		0,85
	NEW A 170 (169.032, 169.332)	M 266.940	85/116	09.2004	06.2012	FC 52 LZWR	A543		0,85
	NEW A 180 (169.032, 169.332)	M 266.940	85/116	04.2009	06.2012	FC 52 LZWR	A543		0,85
	NEW A 200 (169.033, 169.333)	M 266.960	100/136	09.2004	06.2012	FC 52 LZWR	A543		0,85
Class B (W245)	NEW B 150 (245.231)	M 266.920	70/95	03.2005	11.2011	FC 52 LZWR	A543		0,85
	NEW B 160 (245.231)	M 266.920	70/95	04.2009	11.2011	FC 52 LZWR	A543		0,85
	NEW B 170 (245.232)	M 266.940	85/116	03.2005	11.2011	FC 52 LZWR	A543		0,85
	NEW B 170 NGT (245.233)	M 266.960	85/116	04.2008	11.2011	FC 52 LZWR	A543		0,85
	NEW B 180 (245.232)	M 266.940	85/116	04.2009	11.2011	FC 52 LZWR	A543		0,85
	NEW B 180 NGT (245.233)	M 266.960	85/116	04.2008	11.2011	FC 52 LZWR	A543		0,85
	NEW B 200 (245.233)	M 266.960	100/136	03.2005	11.2011	FC 52 LZWR	A543		0,85
Class C Break (S202)	C 180 T (202.078)	M 111.920	90/122	06.1996	06.1997	FC 42 LS	A15	B14	0,8 F54
	C 180 T (202.078)	M 111.921	90/122	07.1997	09.2000	RFC 58 LZ3EX	A58	B55	0,9 F54
	C 180 T (202.081)	M 111.952	95/129	09.2000	02.2001	RFN 58 LZDP5	A187		1,05
	C 200 T (202.080)	M 111.941- M 111.945	100/136	06.1996	06.1997	FC 42 LS	A15	B14	0,8 F54
	C 200 T (202.080)	M 111.941- M 111.945	100/136	07.1997	03.2001	RFC 58 LZ3EX	A58	B55	0,9 F54
	C 200 T Kompressor (202.082)	M 111.944	141/192	11.1996	03.2000	RFC 58 LZ3EX	A58	B55	0,9 F54
	C 200 T Kompressor (202.087)	M 111.956	120/163	09.2000	02.2001	RFN 58 LZDP5	A187		1,05
	C 230 T (202.083)	M 111.974	110/150	06.1996	05.1997	FC 42 LS	A15	B14	0,8 F54
	C 230 T Kompressor (202.083)	M 111.975	142/193	06.1997	09.2000	RFC 58 LZ3EX	A58	B55	0,9 F54
	C 240 T (202.086)	M 112.910	125/170	06.1997	09.2000	FN 42 LZDPR5	A195		1,05
	C 240 T (202.086)	M 112.915	125/170	09.2000	02.2001	FN 42 LZDPR5	A195		1,05

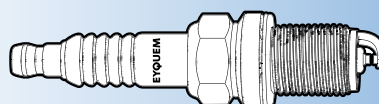

- (1) Available until end of stock
- (a) 30 000 km
- (b) 60 000 km
- (c) Grey sticker on ignition coil
- (d) Green sticker on ignition coil

- (e) Hex 21 mm
- (f) Hex 16 mm
- (g) Recommended for cold weather



KW/HP



Box
10

Blister
4



F3

MERCEDES

	C 280 T (202.089)	M 112.920	145/197	06.1997	02.2001	FN 42 LZDPR5	A195		1,05
	C 43 AMG (202.093)	M 113.944	225/306	06.1997	02.2001	FN 42 LZDPR5	A195		1,05
Class C (S203)	C 180 Kompressor (203.246)	M 271.946	105/143	05.2002	08.2007	RFN 62 HZDP	A504		0,8
	C 200 CGI Kompressor (203.243)	M 271.942	125/170	07.2003	08.2007	RFN 62 HZDP	A504		0,8
	C 200 Kompressor (203.242)	M 271.940	120/163	05.2002	08.2007	RFN 62 HZDP	A504		0,8
	C 230 Kompressor (203.240)	M 271.948	141/192	02.2004	08.2007	RFN 62 HZDP	A504		0,8
	C 240 4-matic Kombi (S203)	M 112.916	125/170	07.2002		FN 42 LZDPR5	A195		1,05
	C 240 Kombi (S203)	M 112.912	125/170	03.2001		FN 42 LZDPR5	A195		1,05
	C 320 4-matic Kombi (S203)	M 112.953	160/218	07.2002		FN 42 LZDPR5	A195		1,05
	C 320 Kombi (S203)	M 112.946	160/218	03.2001		FN 42 LZDPR5	A195		1,05
	C 350 4-matic Kombi (S203)	M 272.970	200/272	01.2005		FN 42 LZDPR5	A195		1,05
	C 350 Kombi (S203)	M 272.960	200/272	01.2005		FN 42 LZDPR5	A195		1,05
Class C (S204)	C 180 Kompressor (204.246)	M 271.952	115/156	08.2007		ZN 68 HSTDPR	A527		0,8
	C 200 Kompressor (204.241)	M 271.950	135/184	08.2007		ZN 68 HSTDPR	A527		0,8
	C 230 (204.252)	M 272.921	150/204	08.2007		ZN 68 HSTDPR	A527		0,8
	C 280 (204.254)	M 272.947	170/231	08.2007		ZN 68 HSTDPR	A527		0,8
Class C (W202)	C 180 1.8 (202.018)	M 111.921	89/121	11.1994	06.1997	FC 42 LS	A15	B14	0,8 F54
	C 180 1.8 (202.018)	M 111.921	89/121	07.1997	05.2000	RFC 58 LZ3EX	A58	B55	0,9 F54
	C 180 1.8 (202.018)	M 111.920 - M 111.921	90/122	03.1993	06.1997	FC 42 LS	A15	B14	0,8 F54
	C 180 1.8 (202.018)	M 111.920 - M 111.921	90/122	07.1997	05.2000	RFC 58 LZ3EX	A58	B55	0,9 F54
	C 200 2.0 (202.020)	M 111.941 - M 111.945	100/136	01.1994	06.1997	FC 42 LS	A15	B14	0,8 F54
	C 200 2.0 (202.020)	M 111.941 - M 111.945	100/136	07.1997	05.2000	RFC 58 LZ3EX	A58	B55	0,9 F54
	C 200 Kompressor (202.025)	M 111.944	132/180	10.1995	05.2000	RFC 58 LZ3EX	A58	B55	0,9 F54
	C 200 Kompressor (202.025)	M 111.944	141/192	11.1996	05.2000	RFC 58 LZ3EX	A58	B55	0,9 F54
	C 220 2.2 (202.022)	M 111.961	110/150	03.1993	09.1996	FC 42 LS	A15	B14	0,8 F54
	C 230 2.3 (202.023)	M 111.974	110/150	06.1996	06.1997	FC 42 LS	A15	B14	0,8 F54
	C 230 Kompressor (202.024)	M 111.975	142/193	10.1995	05.2000	RFC 58 LZ3EX	A58	B55	0,9 F54
	C 240 (202.026)	M 112.906	125/170	06.1997	04.2000	RFN 58 LZDP5	A187		1,05
	C 280 2.8 (202.028)	M 104.941	142/193	05.1993	05.1997	FC 42 LS	A15	B14	0,8 F54
	C 280 2.8 (202.028)	M 112.920	145/197	06.1997	04.2000	FN 42 LZDPR5	A195		1,05
	C 36 3.6 AMG (202.028)	M 104.941 (AMG 3.6)	206/280	01.1994	05.1997	FC 42 LS	A15	B14	0,8 F54
	C 43 AMG (202.033)	M 113.944	225/306	09.1997	05.2000	FN 42 LZDPR5	A195		1,05
Class C (W203)	C 180 (203.035)	M 111.951	95/129	10.2000	05.2002	RFN 58 LZDP5	A187		1,05
	C 180 Kompressor (203.046)	M 271.946	105/143	05.2002	11.2006	RFN 62 HZDP	A504		0,8
		engine n° ->30853899							
	C 180 Kompressor (203.046)	M 271.946	105/143	12.2006	02.2007	ZN 68 HSTDPR	A527		0,8
		engine n° 30853900 ->							
	C 200 Kompressor (203.042)	M 271.940	120/163	05.2002	11.2006	RFN 62 HZDP	A504		0,8
		engine n° ->30853899							
	C 200 Kompressor (203.042)	M 271.940	120/163	12.2006	02.2007	ZN 68 HSTDPR	A527		0,8
		engine n° 30853900 ->							
	C 200 Kompressor (203.045)	M 111.955	120/163	05.2000	06.2002	RFN 58 LZDP5	A187		1,05
	C 200 CGI Kompressor (203.043)	M 271.942	125/170	07.2003	04.2005	RFN 62 HZDP	A504		0,8
		engine n° ->30853899							
	C 200 CGI Kompressor (203.043)	M 271.942	125/170	05.2005	02.2007	ZN 68 HSTDPR	A527		0,8
		engine n° 30853900 ->							
	C 230 Kompressor (203.040)	M 271.948	141/192	02.2004	05.2005	RFN 62 HZDP	A504		0,8
		engine n° ->30853899							
	C 230 Kompressor (203.040)	M 271.948	141/192	06.2005	02.2007	ZN 68 HSTDPR	A527		0,8
		engine n° 30853900 ->							
	C 230 (203.052)	M 272.920	150/204	01.2005	02.2007	ZN 68 HSTDPR	A527		0,8
	C 240 (203.061)	M 112.912	125/170	05.2000	05.2005	FN 42 LZDPR5	A195		1,05
	C 240 4-matic (203.081)	M 112.916	125/170	07.2002	02.2007	FN 42 LZDPR5	A195		1,05
	C 280 (203.054)	M 272.940	170/231	01.2005	02.2007	ZN 68 HSTDPR	A527		0,8
	C 280 4-matic (203.092)	M 272.941	170/231	01.2005	02.2007	ZN 68 HSTDPR	A527		0,8
	C 320 (203.064)	M 112.946	160/218	05.2000	05.2005	FN 42 LZDPR5	A195		1,05
	C 320 4-matic (203.084)	M 112.953	160/218	07.2002	02.2007	FN 42 LZDPR5	A195		1,05
	C 32 AMG Kompressor (203.065)	M 112.961	260/354	02.2001	01.2004	RFN 58 LZDP5	A187		1,05
	C 350 (203.056)	M 272.960	200/272	01.2005	02.2007	ZN 68 HSTDPR	A527		0,8
	C 350 4-matic (203.087)	M 272.970	200/272	01.2005	02.2007	ZN 68 HSTDPR	A527		0,8
Class C (W204)	C 180 CGI (204.031)	M 274.910	115/156	01.2008	01.2014	ZN 68 HSTDPR	A527		0,8
	C 180 Kompressor (204.044, 204.045)	M 271.910	115/156	01.2008	01.2014	ZN 68 HSTDPR	A527		0,8
	C 180 Kompressor (204.046)	M 271.952	115/156	01.2007	01.2014	ZN 68 HSTDPR	A527		0,8
	C 180 CGI (204.049)	M 271.820	115/156	01.2007	01.2014	ZN 68 HSTDPR	A527		0,8
	C 200 Kompressor (204.041)	M 271.950	135/184	01.2007	01.2014	ZN 68 HSTDPR	A527		0,8

(1) Available until end of stock

(a) 30 000 km

(b) 60 000 km

(c) Grey sticker on ignition coil

(d) Green sticker on ignition coil

(e) Hex 21 mm

(f) Hex 16 mm

(g) Recommended for

cold weather



EYQUEM



Box 10
Blister 4



F3-1

MERCEDES

	C 200 CGI (204.048)	M 271.820- M 271.860	135/184	01.2007	01.2014	ZN 68 HSTDPR	A527	0,8
	C 230 (204.052)	M 272.921	150/204	01.2007	01.2014	ZN 68 HSTDPR	A527	0,8
	C 230 4-matic (204.085)	M 272.911	150/204	07.2007	01.2014	ZN 68 HSTDPR	A527	0,8
	C 250 CGI (204.047)	M 271.860	150/204	07.2009	01.2014	ZN 68 HSTDPR	A527	0,8
	C 280 (204.054)	M 272.947	170/231	07.2007	01.2014	ZN 68 HSTDPR	A527	0,8
	C 280 4-matic (204.081)	M 272.948	170/231	07.2007	01.2014	ZN 68 HSTDPR	A527	0,8
	C 300 (204.054)	M 272.947	170/231	07.2009	01.2014	ZN 68 HSTDPR	A527	0,8
	C 300 4-matic (204.081)	M 272.948	170/231	07.2007	01.2014	ZN 68 HSTDPR	A527	0,8
	C 350 (204.056)	M 272.961	200/272	01.2007	01.2014	ZN 68 HSTDPR	A527	0,8
	C 350 4-matic (204.087)	M 272.961	200/272	07.2007	01.2014	ZN 68 HSTDPR	A527	0,8
Class C (W205)	C 180 (205.040)	M 274.910	115/156	03.2014		ZN 68 HSTDPR	A527	0,8
Class C Coupe (C204)	C 180 (204.331)	M 274.910	115/156	01.2013		ZN 68 HSTDPR	A527	0,8
	C 180 (204.349)	M 271.820	115/156	06.2011		ZN 68 HSTDPR	A527	0,8
	C 200 CGI (204.348)	M 271.820	135/184	06.2011		ZN 68 HSTDPR	A527	0,8
	C 250 (204.347)	M 271.860	150/204	06.2011		ZN 68 HSTDPR	A527	0,8
Class C Sportcoupe (CL203)	C 160 Kompressor (203.730)	M 271.921 engine n° ->30853899	90/122	05.2002	11.2006	RFN 62 HZDP	A504	0,8
	C 160 Kompressor (203.730)	M 271.921 engine n° 30853900 ->	90/122	12.2006	05.2008	ZN 68 HSTDPR	A527	0,8
	C 180 Kompressor (203.746)	M 271.946 engine n° ->30853899	105/143	05.2002	11.2006	RFN 62 HZDP	A504	0,8
	C 180 Kompressor (203.746)	M 271.946 engine n° 30853900 ->	105/143	12.2006	05.2008	ZN 68 HSTDPR	A527	0,8
	C 180 (203.735)	M 111.951	95/129	03.2001	05.2002	RFN 58 LZDP5	A187	1,05
	C 200 Kompressor (203.742)	M 271.940 engine n° ->30853899	120/163	05.2002	11.2006	RFN 62 HZDP	A504	0,8
	C 200 Kompressor (203.742)	M 271.940 engine n° 30853900 ->	120/163	12.2006	05.2008	ZN 68 HSTDPR	A527	0,8
	C 200 Kompressor (203.745)	M 111.955	120/163	03.2001	05.2002	RFN 58 LZDP5	A187	1,05
	C 200 CGI Kompressor (203.743)	M 271.942 engine n° ->30853899	125/170	03.2003	04.2005	RFN 62 HZDP	A504	0,8
	C 200 CGI Kompressor (203.743)	M 271.942 engine n° 30853900 ->	125/170	05.2005	05.2008	ZN 68 HSTDPR	A527	0,8
	C 230 (203.752)	M 272.920	150/204	01.2005	05.2008	ZN 68 HSTDPR	A527	0,8
	C 230 Kompressor (203.740)	M 271.948 engine n° ->30853899	141/192	05.2002	05.2005	RFN 62 HZDP	A504	0,8
	C 230 Kompressor (203.740)	M 271.948 engine n° 30853900 ->	141/192	06.2005	05.2008	ZN 68 HSTDPR	A527	0,8
	C 230 Kompressor (203.747)	M 111.981	145/197	03.2001	05.2002	RFN 58 LZDP5	A187	1,05
	C 320 Sportcoupe (203.764)	M 112.946	160/218	09.2002	05.2008	FN 42 LZDPR5	A195	1,05
	C 32 AMG Kompressor (203.765)	M 112.961	260/354	05.2002	05.2008	RFN 58 LZDP5	A187	1,05
	C 350 Sportcoupe (203.756)	M 272.960	200/272	01.2005	05.2008	ZN 68 HSTDPR	A527	0,8
Class CLC (CL203)	CLC 160 (203.731)	M 271.911	95/129	02.2009	06.2011	ZN 68 HSTDPR	A527	0,8
	CLC 180 (203.746)	M 271.946	105/143	05.2008	06.2011	ZN 68 HSTDPR	A527	0,8
	CLC 200 Kompressor (203.741)	M 271.957	135/184	05.2008	06.2011	ZN 68 HSTDPR	A527	0,8
	CLC 230 (203.752)	M 272.920	150/204	05.2008	06.2011	ZN 68 HSTDPR	A527	0,8
	CLC 350 (203.756)	M 272.960	200/272	05.2008	06.2011	ZN 68 HSTDPR	A527	0,8
Class C-T Model (S203)	C 180 Kompressor (203.246)	M 271.946 engine n° ->30853899	105/143	05.2002	11.2006	RFN 62 HZDP	A504	0,8
	C 180 Kompressor (203.246)	M 271.946 engine n° 30853900 ->	105/143	12.2006	08.2007	ZN 68 HSTDPR	A527	0,8
	C 180 (203.235)	M 111.951	95/129	03.2001	05.2002	RFN 58 LZDP5	A187	1,05
	C 200 Kompressor (203.242)	M 271.940 engine n° ->30853899	120/163	05.2002	11.2006	RFN 62 HZDP	A504	0,8
	C 200 Kompressor (203.242)	M 271.940 engine n° 30853900 ->	120/163	12.2006	08.2007	ZN 68 HSTDPR	A527	0,8
	C 200 Kompressor (203.245)	M 111.955	120/163	03.2001	05.2002	RFN 58 LZDP5	A187	1,05
	C 200 CGI Kompressor (203.243)	M 271.942	125/170	07.2003	04.2005	RFN 62 HZDP	A504	0,8
	C 200 CGI Kompressor (203.243)	M 271.942	125/170	05.2005	08.2007	ZN 68 HSTDPR	A527	0,8
	C 230 Kompressor (203.240)	M 271.948	141/192	02.2004	05.2005	RFN 62 HZDP	A504	0,8
	C 230 Kompressor (203.240)	M 271.948	141/192	06.2005	08.2007	ZN 68 HSTDPR	A527	0,8
	C 230 (203.252)	M 272.920	150/204	01.2005	08.2007	ZN 68 HSTDPR	A527	0,8
	C 240 (203.261)	M 112.912	125/170	03.2001	05.2005	FN 42 LZDPR5	A195	1,05
	C 240 4-matic (203.281)	M 112.916	125/170	07.2002	08.2007	FN 42 LZDPR5	A195	1,05
	C 280 (203.254)	M 272.940	170/231	01.2005	08.2007	ZN 68 HSTDPR	A527	0,8



(1) Available until end of stock

- (a) 30 000 km
- (b) 60 000 km
- (c) Grey sticker on ignition coil
- (d) Green sticker on ignition coil

- (e) Hex 21 mm
- (f) Hex 16 mm
- (g) Recommended for cold weather



KW/HP

Box
10Blister
4

F3D1

MERCEDES

	C 280 4-matic (203.292)	M 272.941	170/231	01.2005	08.2007	ZN 68 HSTDPR	A527		0,8		
	C 320 (203.264)	M 112.946	160/218	03.2001	05.2005	FN 42 LZDPR5	A195		1,05		
	C 320 4-matic (203.284)	M 112.953	160/218	07.2002	08.2007	FN 42 LZDPR5	A195		1,05		
	C 350 (203.256)	M 272.960	200/272	01.2005	08.2007	ZN 68 HSTDPR	A527		0,8		
	C 350 4-matic (203.287)	M 272.970	200/272	01.2005	08.2007	ZN 68 HSTDPR	A527		0,8		
	C 32 AMG Kompressor (203.265)	M 112.961	260/354	03.2001	01.2004	RFN 58 LZDP5	A187		1,05		
	C 55 AMG (203.276)	M 133.988	270/367	02.2004	08.2007	RFN 58 LZDP5	A187		1,05		
Class C-T Model (S204)	C 180 (204.231)	M 274.910	115/156	02.2012	08.2014	ZN 68 HSTDPR	A527		0,8		
	C 180 Kompressor (204.245)	M 271.910	115/156	01.2008	08.2014	ZN 68 HSTDPR	A527		0,8		
	C 180 Kompressor (204.246)	M 271.952	115/156	08.2007	08.2014	ZN 68 HSTDPR	A527		0,8		
	C 180 CGI (204.249)	M 271.820	115/156	11.2009	08.2014	ZN 68 HSTDPR	A527		0,8		
	C 200 Kompressor (204.241)	M 271.950	135/184	08.2007	08.2014	ZN 68 HSTDPR	A527		0,8		
	C 200 CGI (204.248)	M 271.820- M 271.860	135/184	08.2007	08.2014	ZN 68 HSTDPR	A527		0,8		
	C 230 (204.252)	M 272.921	150/204	08.2007	08.2014	ZN 68 HSTDPR	A527		0,8		
	C 250 CGI (204.247)	M 271.860	150/204	07.2009	08.2014	ZN 68 HSTDPR	A527		0,8		
	C 280 (204.254)	M 272.947	170/231	08.2007	08.2014	ZN 68 HSTDPR	A527		0,8		
	C 300 (204.054)	M 272.947	170/231	08.2007	08.2014	ZN 68 HSTDPR	A527		0,8		
	C 350 (204.256)	M 272.961	200/272	08.2007	08.2014	ZN 68 HSTDPR	A527		0,8		
Class C-T Model (S205)	C 180 (205.240)	M 274.910	115/156	09.2014		ZN 68 HSTDPR	A527		0,8		
Class E (A124)	E 200 : 2.0 Cabriolet (A124)	M 111.940	100/136	06.1993	03.1998	FC 42 LS	A15	B14	0,8	F54	
	E 220 : 2.2 Cabriolet (A124)	M 111.960	110/150	06.1993	03.1998	FC 42 LS	A15	B14	0,8	F54	
	E 320 : 3.2 Cabriolet (A124)	M 104.992/M 104.995	162/220	06.1993	03.1998	FC 42 LS	A15	B14	0,8	F54	
	E 36 AMG : 3.6 Cabriolet (A124)	M 104.992 (AMG 3.6)	200/272	05.1994	03.1998	FC 42 LS	A15	B14	0,8	F54	
Class E (A207)	E 500 (207.472)	M 273.966	285/388	01.2010		ZN 68 HSTDPR	A527		0,8		
Class E (C124)	E 200 : 2.0 Coupe (C124)	M 111.940	100/136	06.1993	06.1997	FC 42 LS	A15	B14	0,8	F54	
	E 220 : 2.2 Coupe (C124)	M 111.960	110/150	06.1993	06.1997	FC 42 LS	A15	B14	0,8	F54	
	E 320 : 3.2 Coupe (C124)	M 104.992	162/220	06.1993	06.1997	FC 42 LS	A15	B14	0,8	F54	
	E 36 AMG : 3.6 Coupe (C124)	M 104.992 (AMG 3.6)	200/272	05.1994	06.1997	FC 42 LS	A15	B14	0,8	F54	
Class E (C207)	E 500 (207.372)	M 273.966	285/388	01.2009		ZN 68 HSTDPR	A527		0,8		
Class E (S124)	E 200 T : 2.0 Kombi (S124)	M 111.940	100/136	06.1993	06.1996	FC 42 LS	A15	B14	0,8	F54	
	E 220 T : 2.2 Kombi (S124)	M 111.960	110/150	06.1993	06.1996	FC 42 LS	A15	B14	0,8	F54	
	E 280 T : 2.8 Kombi (S124)	M 104.942	142/193	06.1993	06.1996	FC 42 LS	A15	B14	0,8	F54	
	E 280 T : 2.8 Kombi (S124)	M 104.942	145/197	06.1993	06.1996	FC 42 LS	A15	B14	0,8	F54	
	E 320 T : 3.2 Kombi (S124)	M 104.992	162/220	06.1993	06.1996	FC 42 LS	A15	B14	0,8	F54	
	E 36 T AMG : 3.6 Kombi (S124)	M 104.992 (AMG 3.6)	200/272	05.1994	06.1996	FC 42 LS	A15	B14	0,8	F54	
Class E Break (S210)	E 200 T (210.235)	M 111.942	100/136	06.1996	06.1997	FC 42 LS	A15	B14	0,8	F54	
	E 200 T (210.235)	M 111.942	100/136	07.1997	08.2000	RFC 58 LZ3EX	A58	B55	0,9	F54	
	E 200 T Kompressor (210.248)	M 111.957	120/163	08.2000	03.2003	RFN 58 LZDP5	A187		1,1		
	E 200 T Kompressor (210.245)	M 111.947	137/186	06.1997	03.2003	RFC 58 LZ3EX	A58	B55	1,0	F54	
	E 230 T (210.237)	M 111.970	110/150	06.1996	06.1997	FC 42 LS	A15	B14	0,8	F54	
	E 240 T (210.261)	M 112.911	125/170	09.1997	03.2003	FN 42 LZDPR5	A195		1,05		
	E 240 T (210.262)	M 112.914	125/170	08.2000	01.2003	FN 42 LZDPR5	A195		1,05		
	E 280 T (210.263)	M 112.921	150/204	12.1996	01.2003	FN 42 LZDPR5	A195		1,05		
	E 280 T 4-matic (210.281)	M 112.921	150/204	03.1997	01.2003	FN 42 LZDPR5	A195		1,05		
	E 320 T (210.265)	M 112.921	165/224	03.1997	01.2003	FN 42 LZDPR5	A195		1,05		
	E 320 T 4-matic (210.282)	M 112.941	165/224	06.1997	02.2003	FN 42 LZDPR5	A195		1,05		
	E 420 T (210.272)	M 119.985	205/279	06.1996	06.1997	FC 42 LS	A15	B14	0,8	F54	
	E 430 T (210.270)	M 113.940	205/279	09.1997	01.2003	FN 42 LZDPR5	A195		1,05		
	E 430 T 4-matic (210.283)	M 113.940	205/279	05.1999	01.2003	FN 42 LZDPR5	A195		1,05		
	E 55 T AMG (210.274)	M 113.980	260/354	03.1998	01.2003	FN 42 LZDPR5	A195		1,05		
	E 55 T AMG 4-matic (210.283)	M 113.980	260/354	02.2002	03.2003	FN 42 LZDPR5	A195		1,05		
	Class E (S211)	E 200 Kompressor (211.241)	M 271.956	135/184	04.2006	07.2009	RFN 62 HZDP	A504		0,8	
		E 200 T Kompressor (211.242)	M 271.941	120/163	03.2003	07.2009	RFN 62 HZDP	A504		0,8	
		E 320 T 4-matic Kombi (S211)	M 112.954	165/225	07.2003		FN 42 LZDPR5	A195		1,05	
E 320 T Kombi (S211)		M 112.949	165/225	03.2003		FN 42 LZDPR5	A195		1,05		
E 500 T 4-matic Kombi (S211)		M 113.969	225/306	10.2003		FN 42 LZDPR5	A195		1,05		
E 500 T Kombi (S211)		M 113.967	225/306	10.2003		FN 42 LZDPR5	A195		1,05		
E 55 T AMG Kompressor (211.276)		M 113.990	350 / 476	07.2003	07.2009	RFN 62 HZDP	A504		0,8		
Class E (S212)	E 500 (212.272)	M 273.971	285/388	11.2009		ZN 68 HSTDPR	A527		0,8		
Class E (W124)	E 200 (124.019)	M 111.940	100/136	06.1993	06.1995	FC 42 LS	A15	B14	0,8	F54	
	E 220 (124.022)	M 111.960	110/150	06.1993	06.1995	FC 42 LS	A15	B14	0,8	F54	
	E 280 (124.029)	M 104.942	142/193	06.1993	06.1995	FC 42 LS	A15	B14	0,8	F54	
	E 280 (124.028)	M 104.942	145/197	06.1993	06.1995	FC 42 LS	A15	B14	0,8	F54	
	E 300 4-matic (124.230)	M 103.985	132/180	06.1993	06.1995	C 62 LJS	A19	B2	0,8	J65	
	E 320 (124.032)	M 104.992	162/220	06.1993	06.1995	FC 42 LS	A15	B14	0,8	F54	

(1) Available until end of stock

(a) 30 000 km

(b) 60 000 km

(c) Grey sticker on ignition coil

(d) Green sticker on ignition coil

(e) Hex 21 mm

(f) Hex 16 mm

(g) Recommended for

cold weather

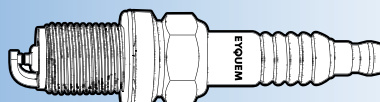

EYQUEM

121



Box 10
Blister 4



F3 → 1

MERCEDES

	E 420 (124.034)	M 119.975	205/279	06.1993	06.1995	FC 42 LS	A15	B14	0,8	F54
	E 500 (124.036)	M 119.974	235/320	06.1993	06.1995	FC 42 LS	A15	B14	0,8	F54
	E 60 AMG (124.036)	M 119.974 (AMG 6.0)	280/381	05.1994	06.1995	FC 42 LS	A15	B14	0,8	F54
Class E Break (S124)	E 200 T (124.079)	M 111.940	100/136	06.1993	06.1996	FC 42 LS	A15	B14	0,8	F54
	E 220 T (124.082)	M 111.960	110/150	06.1993	06.1996	FC 42 LS	A15	B14	0,8	F54
	E 280 T (124.088)	M 104.942	142/193	06.1993	06.1996	FC 42 LS	A15	B14	0,8	F54
	E 280 T (124.088)	M 104.942	145/197	06.1993	06.1996	FC 42 LS	A15	B14	0,8	F54
	E 300 T 4-matic (124.290)	M 103.985	132/180	06.1993	06.1996	C 62 LJS	A19	B2	0,8	J65
	E 300 TE-24 AMG (124.091)	M 104.980	162/220	06.1993	06.1996	FC 42 LS	A15	B14	0,8	F54
	E 320 T (124.092)	M 104.992	162/220	06.1993	06.1996	FC 42 LS	A15	B14	0,8	F54
	E 36 T AMG (124.092)	M 104.992 (AMG 3.6)	200/272	05.1994	06.1996	FC 42 LS	A15	B14	0,8	F54
Class E Cabriolet (A124)	200 (124.160)	M 111.940	100/136	06.1993	03.1998	FC 42 LS	A15	B14	0,8	F54
	220 (124.062)	M 111.960	110/150	06.1993	03.1998	FC 42 LS	A15	B14	0,8	F54
	300 CE 24 (124.061)	M 104.980	162/220	04.1992	06.1993	FC 42 LS	A15	B14	0,8	F54
	320 (124.066)	M 104.992	162/220	06.1993	03.1998	FC 42 LS	A15	B14	0,8	F54
	300 CE (124.061)	M 104.980	162/220	04.1992	09.1993	FC 42 LS	A15	B14	0,8	F54
	E 36 AMG (124.052)	M 104.992 (AMG 3.6)	200/272	05.1994	03.1998	FC 42 LS	A15	B14	0,8	F54
Class E Cabriolet (A207)	E 200 CGI (207.448)	M 271.820- M 271.860	135/184	01.2010		ZN 68 HSTDPR	A527		0,8	
	E 250 CGI (207.447)	M 271.860	150/204	01.2010		ZN 68 HSTDPR	A527		0,8	
	E 500 (207.472)	M 273.966	285/388	01.2010		ZN 68 HSTDPR	A527		0,8	
Class E Coupé (C124)	200	M 111.940	100/136	06.1993	06.1997	FC 42 LS	A15	B14	0,8	F54
	220 CE (124.042)	M 111.960	110/150	10.1992	06.1997	FC 42 LS	A15	B14	0,8	F54
	230 CE (124.043)	M 102.982	97/132	03.1987	12.1992	C 62 LJS	A19	B2	0,8	J65
	230 CE CAT (124.043)	M 102.982	97/132	06.1989	12.1992	C 52 LJS	A23		0,8	J65
	230 CE (124.043)	M 102.982	100/136	03.1987	12.1992	C 62 LJS	A19	B2	0,8	J65
	300 CE (124.050)	M 103.983	132/180	03.1987	05.1993	C 52 LJS	A23		0,8	J65
	300 CE	M 103.983	138/188	03.1987	12.1989	C 52 LJS	A23		0,8	J65
	300 CE-24 (124.051)	M 104.980	162/220	09.1989	12.1992	FC 42 LS	A15	B14	0,8	F54
	320 CE (124.052)	M 104.992	162/220	10.1992	06.1997	FC 42 LS	A15	B14	0,8	F54
	E 36 AMG (124.052)	M 104.992 (AMG 3.6)	195/265	06.1993	04.1995	FC 42 LS	A15	B14	0,8	F54
	E 36 AMG (124.052)	M 104.992 (AMG 3.6)	200/272	05.1994	06.1997	FC 42 LS	A15	B14	0,8	F54
Class E Coupé (C207)	E 200 CGI (207.348)	M 271.820- M 271.860	135/184	01.2010		ZN 68 HSTDPR	A527		0,8	
	E 250 CGI (207.347)	M 271.860	150/204	01.2009		ZN 68 HSTDPR	A527		0,8	
	E 500 (207.372)	M 273.966	285/388	01.2009		ZN 68 HSTDPR	A527		0,8	
Class E Kombi Break (S124)	200 T (124.080)	M 102.922 Cat	77-80/105-109	09.1985	05.1990	C 52 LJS	A23		0,8	J65
	200 T (124.080)	M 102.922	77/105	01.1986	05.1990	C 62 LJS	A19	B2	0,8	J65
	200 T (124.080)	M 102.922	80/109	09.1985	08.1989	C 62 LJS	A19	B2	0,8	J65
	200 TE (124.081)	M 102.963	87/118	09.1988	08.1992	C 62 LJS	A19	B2	0,8	J65
	200 TE	M 102.962	90/122	09.1988	12.1989	C 62 LJS	A19	B2	0,8	J65
	200 TE (124.079)	M 111.940	100/136	05.1986	06.1993	FC 42 LS	A15	B14	0,8	F54
	220 TE (124.082)	M 111.960	110/150	10.1992	05.1993	FC 42 LS	A15	B14	0,8	F54
	230 TE (124.083)	M 102.982	97/132	09.1985	08.1992	C 62 LJS	A19	B2	0,8	J65
	230 TE (124.083)	M 102.982 Cat	97/132	06.1989	08.1992	C 62 LJS	A19	B2	0,8	J65
	230 TE (124.083)	M 102.982	100/136	09.1985	08.1992	C 62 LJS	A19	B2	0,8	J65
	260 TE FGST	M 103.940	118/160	09.1989	08.1992	C 52 LJS	A23		0,8	J65
	260 TE FGST	M 103.940	122/166	09.1985	12.1989	C 52 LJS	A23		0,8	J65
	280 TE (124.088)	M 104.942	145/197	10.1992	06.1993	FC 42 LS	A15	B14	0,8	F54
	300 TE (124.090)	M 103.943	132/180	01.1986	08.1992	C 52 LJS	A23		0,8	J65
	300 4-matic (124.290)	M 103.985	132/180	09.1986	06.1993	C 52 LJS	A23		0,8	J65
	300 TE- TE 4-matic (124.090)	M 103.983	138/188	01.1986	12.1989	C 52 LJS	A23		0,8	J65
	300 TE 24 (124.091)	M 104.980	162/220	09.1989	08.1992	FC 42 LS	A15	B14	0,8	F54
	300 TE 24 (124.092)	M 104.992	162/220	10.1992	06.1993	FC 42 LS	A15	B14	0,8	F54
Class E (W210)	E 200 (210.035)	M 111.942	100/136	06.1995	06.1997	FC 42 LS	A15	B14	0,8	F54
	E 200 (210.035)	M 111.942	100/136	07.1997	08.2000	RFC 58 LZ3EX	A58	B55	0,9	F54
	E 200 Kompressor (210.048)	M 111.957	120/163	08.2000	03.2002	RFN 58 LZDP5	A187		1,1	
	E 200 (210.045)	M 111.947	137/186	06.1997	03.2002	RFC 58 LZ3EX	A58	B55	1,0	F54
	E 230 (210.037)	M 111.970	110/150	06.1995	06.1997	FC 42 LS	A15	B14	0,8	F54
	E 240 (210.061)	M 112.911	125/170	06.1997	04.2000	FN 42 LZDPR5	A195		1,05	
	E 240 (210.062)	M 112.914	125/170	08.2000	03.2002	FN 42 LZDPR5	A195		1,05	
	E 280 (210.053)	M 104.945	142/193	01.1996	06.1997	FC 42 LS	A15	B14	0,8	F54
	E 280 (210.063)	M 104.945	150/204	12.1996	03.2002	FN 42 LZDPR5	A195		1,05	
	E 280 4-matic (210.081)	M 112.921	150/204	03.1997	03.2002	FN 42 LZDPR5	A195		1,05	
	E 320 (210.055)	M 104.992	162/220	06.1995	06.1997	FC 42 LS	A15	B14	0,8	F54
	E 320 (210.065)	M 112.941	165/224	06.1997	03.2002	FN 42 LZDPR5	A195		1,05	

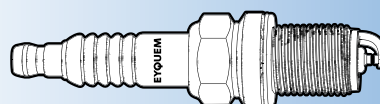

(1) Available until end of stock

- (a) 30 000 km
- (b) 60 000 km
- (c) Grey sticker on ignition coil
- (d) Green sticker on ignition coil

- (e) Hex 21 mm
- (f) Hex 16 mm
- (g) Recommended for cold weather



KW/HP

Box
10 Blister
4

F3-1

MERCEDES

	E 320 4-matic (210.082)	M 112.941	165/224	09.1997	03.2002	FN 42 LZDPR5	A195		1,05	
	E 420 (210.072)	M 119.985	205/279	01.1996	06.1997	FC 42 LS	A15	B14	0,8	F54
	E 430 (210.070)	M 119.985	205/279	09.1997	03.2002	FN 42 LZDPR5	A195		1,05	
	E 430 4-matic (210.083)	M 119.985	205/279	05.1999	03.2002	FN 42 LZDPR5	A195		1,05	
	E 50 AMG (210.072)	M 119.985 (AMG 5.0)	255/347	02.1996	08.1997	FC 42 LS	A15	B14	0,8	F54
	E 55 AMG (210.074)	M 112.980	260/354	08.1997	03.2002	FN 42 LZDPR5	A195		1,05	
	E 55 AMG 4-matic (210.074)	M 112.980	260/354	03.2001	03.2002	FN 42 LZDPR5	A195		1,05	
Class E (W211)	E 200 Kompressor (211.042)	M 271.941	120/163	11.2002	11.2006	RFN 62 HZDP	A504		0,8	
		Engine n°->30853899								
	E 200 Kompressor (211.042)	M 271.941	120/163	12.2006	12.2008	ZN 68 HSTDPR	A527		0,8	
		Engine n° 30853900->								
	E 200 NGT (211.041)	M 271.941	120/163	03.2004	11.2006	RFN 62 HZDP	A504		0,8	
		Engine n°->30853899								
	E 200 NGT (211.041)	M 271.941	120/163	12.2006	12.2008	ZN 68 HSTDPR	A527		0,8	
		Engine n° 30853900->								
	E 200 CGI	M 271.946	125/170	11.2002	12.2008	RFN 62 HZDP	A504		0,8	
	E 200 CGI	M 271.946	125/170	11.2002	12.2008	RFN 62 HZDP	A504		0,8	
	E 200 Kompressor (211.041)	M 271.956	135/184	04.2006	11.2006	RFN 62 HZDP	A504		0,8	
		Engine n°->30853899								
	E 200 Kompressor (211.041)	M 271.956	135/184	12.2006	12.2008	ZN 68 HSTDPR	A527		0,8	
		Engine n° 30853900->								
	E 230 (211.052)	M 272.922	150/204	09.2007	12.2008	ZN 68 HSTDPR	A527		0,8	
	E 240 (211.061)	M 112.913 - M 112.917	130/177	03.2002	12.2008	FN 42 LZDPR5	A195		1,05	
	E 240 4-matic (211.080)	M 112.917	130/177	03.2003	12.2008	FN 42 LZDPR5	A195		1,05	
	E 280 (211.054)	M 272.943	170/231	03.2005	12.2008	ZN 68 HSTDPR	A527		0,8	
	E 280 4-matic (211.092)	M 272.943	170/231	01.2006	12.2008	ZN 68 HSTDPR	A527		0,8	
	E 320 (211.065)	M 112.949	165/225	03.2002	12.2008	FN 42 LZDPR5	A195		1,05	
	E 320 4-matic (211.082)	M 112.954	165/225	03.2003	12.2008	FN 42 LZDPR5	A195		1,05	
	E 350 (211.056)	M 272.964	200/272	03.2005	12.2008	ZN 68 HSTDPR	A527		0,8	
	E 350 4-matic (211.087)	M 272.972	200/272	03.2005	12.2008	ZN 68 HSTDPR	A527		0,8	
	E 500 (211.070)	M 113.967	225/306	03.2002	12.2008	FN 42 LZDPR5	A195		1,05	
	E 500 4-matic (211.083)	M 113.969	225/306	10.2003	12.2008	FN 42 LZDPR5	A195		1,05	
	E 500 (211.072)	M 273.960	285/388	04.2006	12.2008	ZN 68 HSTDPR	A527		0,8	
	E 500 4-matic (211.090)	M 273.962	285/388	04.2006	12.2008	ZN 68 HSTDPR	A527		0,8	
	E 55 AMG Kompressor (211.076)	M 113.990	350/476	10.2002	12.2008	RFN 62 HZDP	A504		0,8	
Class E (W212)	E 200 NGT (212.041)	M 271.958	120/163	03.2011		ZN 68 HSTDPR	A527		0,8	
		Engine n°->30853899								
	E 200 CGI (212.048, 212.148)	M 271.820- M 271.860	135/184	08.2009		ZN 68 HSTDPR	A527		0,8	
	E 250 CGI (212.047, 212.147)	M 271.860	150/204	01.2009		ZN 68 HSTDPR	A527		0,8	
	E 300 (212.054)	M 272.952	170/231	01.2009		ZN 68 HSTDPR	A527		0,8	
	E 350 (212.056)	M 272.980	200/272	01.2009		ZN 68 HSTDPR	A527		0,8	
	E 350 4-matic (212.087)	M 272.977	200/272	01.2009	08.2011	ZN 68 HSTDPR	A527		0,8	
	E 500 (212.072)	M 273.971	285/388	01.2009		ZN 68 HSTDPR	A527		0,8	
	E 500 4-matic (212.090)	M 273.970	285/388	01.2009		ZN 68 HSTDPR	A527		0,8	
Class E-T Break (S211)	E 200 T Kompressor (111.242)	M 271.941	120/163	03.2003	11.2006	RFN 62 HZDP	A504		0,8	
		Engine n°->30853899								
	E 200 T Kompressor (111.242)	M 271.941	120/163	12.2006	07.2009	ZN 68 HSTDPR	A527		0,8	
		Engine n° 30853900->								
	E 200 Kompressor (111.241)	M 271.956	135/184	04.2006	11.2006	RFN 62 HZDP	A504		0,8	
		Engine n°->30853899								
	E 200 Kompressor (111.241)	M 271.956	135/184	12.2006	07.2009	ZN 68 HSTDPR	A527		0,8	
		Engine n° 30853900->								
	E 230 T (211.252)	M 272.922	150/204	05.2007	07.2009	ZN 68 HSTDPR	A527		0,8	
	E 240 T (211.261)	M 112.913	130/177	03.2003	07.2009	FN 42 LZDPR5	A195		1,05	
	E 240 T 4-matic (211.280)	M 112.917	130/177	07.2003	07.2009	FN 42 LZDPR5	A195		1,05	
	E 280 T (211.254)	M 272.943	170/231	03.2005	07.2009	ZN 68 HSTDPR	A527		0,8	
	E 280 T 4-matic (211.292)	M 272.943	170/231	03.2005	07.2009	ZN 68 HSTDPR	A527		0,8	
	E 320 T (211.265)	M 112.949	165/224	03.2003	07.2009	FN 42 LZDPR5	A195		1,05	
	E 320 T 4-matic (211.282)	M 112.954	165/224	07.2003	07.2009	FN 42 LZDPR5	A195		1,05	
	E 350 T (211.256)	M 272.964	200/272	03.2005	07.2009	ZN 68 HSTDPR	A527		0,8	
	E 350 T 4-matic (211.287)	M 272.972	200/272	03.2005	07.2009	ZN 68 HSTDPR	A527		0,8	
	E 500 T (211.270)	M 113.967	225/306	10.2003	07.2009	FN 42 LZDPR5	A195		1,05	
	E 500 T 4-matic (211.283)	M 113.969	225/306	10.2003	07.2009	FN 42 LZDPR5	A195		1,05	
	E 500 T (211.272)	M 273.960	285/388	04.2006	07.2009	ZN 68 HSTDPR	A527		0,8	
	E 500 T 4-matic (211.290)	M 273.962	285/388	04.2006	07.2009	ZN 68 HSTDPR	A527		0,8	
	E 55 AMG Kompressor (211.276)	M 113.990	350/476	07.2003	07.2009	RFN 62 HZDP	A504		0,8	

(1) Available until end of stock

(a) 30 000 km

(b) 60 000 km

(c) Grey sticker on ignition coil

(d) Green sticker on ignition coil

(e) Hex 21 mm

(f) Hex 16 mm

(g) Recommended for

cold weather

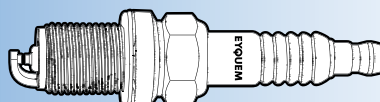

EYQUEM

**kW/HP****Box
10** **Blister
4****F3****MERCEDES**

Class E-T Break (S212)	E 200 CGI (212.248)	M 271.860	135/184	11.2009			ZN 68 HSTDPR	A527		0,8	
	E 250 CGI (212.247)	M 271.860	150/204	11.2009			ZN 68 HSTDPR	A527		0,8	
	E 300 (212.254)	M 272.952	170/231	11.2009			ZN 68 HSTDPR	A527		0,8	
	E 350 (212.256)	M 272.980	200/272	08.2009			ZN 68 HSTDPR	A527		0,8	
	E 350 4-matic (212.287)	M 272.977	200/272	11.2009			ZN 68 HSTDPR	A527		0,8	
	E 500 (212.272)	M 273.971	285/388	11.2009			ZN 68 HSTDPR	A527		0,8	
Class G (W460)	230 G (460,2)	M 115.973	66-75/90-102	03.1979	03.1982		C 72 LS (1)	A30		0,8	L87
	230 G (460,2)	M 115.973	75/102	02.1980	07.1987		C 72 LS (1)	A30		0,8	L87
	230 GE (460,2)	M 102.981	92/125	04.1982	08.1985		C 62 LJS	A19	B2	0,8	J65
	230 GE (460,2)	M 102.987 Cat	90-92/122-125	09.1985	08.1992		C 52 LJS	A23		0,8	J65
	280 GE (460,2)	M 110.994	110-115/150-156	11.1979	08.1989		C 62 LS	A4	B5	0,8	L65
	280 GE (460)	M 102.964		05.1986	03.1992		C 52 LJS	A23		0,8	J65
Class G (W461)	230 GE (461.238, 461.239)	M 102.979	90/122	04.1992	06.1996		C 52 LJS	A23		0,8	J65
	230 GE (W461)	M 102.996 - M 102.997	92/125	06.1993	07.2000		C 62 LJS	A19	B2	0,8	J65
Class G (W463)	200 GE (W463)	M 102.965	87/118	01.1990	07.1993		C 62 LJS	A19	B2	0,8	J65
	230 GE (463.224, 463.225)	M 102.289	93/126	06.1990	06.1993		C 62 LJS	A19	B2	0,8	J65
	230 GE (W463)	M 102.989	92-95/125-129	09.1989	07.1993		C 62 LJS	A19	B2	0,8	J65
	300 GE (463.227, 463.228)	M 103.987	126-128/171-174	09.1989	10.1994		C 52 LJS	A23		0,8	J65
	G 320 (463.230, 463.231)	M 104.996	155/211	08.1993	06.1997		FC 42 LS	A15	B14	0,8	F54
	G 320 (463.232-233-244-245)	M 112.245	158/215	12.1997			FN 42 LZDPR5	A195		1,05	
	G 36 AMG (463.230)	M 104.996 (AMG 3.6)	200/272	01.1995	06.1997		FC 42 LS	A15	B14	0,8	F54
	G 500 E (463.228)	M 117.965	177/241	09.1993	10.1994		C 62 LS	A4	B5	0,8	L65
	500 GE (463)	M 117.965	195/265	03.1993	07.1993		C 62 LS	A4	B5	0,8	L65
	G 500 (463.247, 463.248-249-240)	M 113.962	218/296	01.2000			FN 42 LZDPR5	A195		1,05	
	G 500 (463.202)	M 273.963	285/388	12.2009			ZN 68 HSTDPR	A527		0,8	
	G 55 AMG (463.243, 463.246)	M 113.982	260/354	01.2000			FN 42 LZDPR5	A195		1,05	
	G 55 AMG (463.270, 463.271)	M 113.993	350/476	06.2004			RFN 62 HZDP	A504		0,8	
	G 55 AMG (463.270, 463.271)	M 113.993	368/500	08.2006			RFN 62 HZDP	A504		0,8	
	G 55 AMG (463.270, 463.271)	M 113.993	373/507	08.2008			RFN 62 HZDP	A504		0,8	
Class G Cabrio (W463)	230 GE (463.204)	M 102.289	93/126	06.1990	06.1993		C 62 LJS	A19	B2	0,8	J65
	300 GE (463.207)	M 103.987	125/170	09.1989	10.1994		C 52 LJS	A23		0,8	J65
	320 GE (463.208)	M 104.996	155/211	09.1994	06.1997		FC 42 LS	A15	B14	0,8	F54
	G 320 (463.209)	M 112.245	158/215	12.1997			FN 42 LZDPR5	A195		1,05	
	G 500 (463)	M 113.962	218/296	01.2000			FN 42 LZDPR5	A195		1,05	
	G 500	M 273.963	285/388	12.2009			ZN 68 HSTDPR	A527		0,8	
Class GL (X164)	GL 450 4-matic (164.871)	M 273.923	250/340	09.2006			ZN 68 HSTDPR	A527		0,8	
	GL 500 4-matic (164.886)	M 273.963	285/388	09.2006			ZN 68 HSTDPR	A527		0,8	
Class GLK (X204)	280 4-matic (204.981)	M 272.948	170/231	06.2008	06.2009		ZN 68 HSTDPR	A527		0,8	
	300 4-matic (204.981)	M 272.948	170/231	07.2009	04.2011		ZN 68 HSTDPR	A527		0,8	
	350 (204.956)	M 272.991	200/272	04.2009	06.2015		ZN 68 HSTDPR	A527		0,8	
	350 4-matic (204.987)	M 272.971	200/272	06.2008	04.2011		ZN 68 HSTDPR	A527		0,8	
	ML 230 (163.136)	M 111.977	110/150	11.1998	06.2005		RFC 58 LZ3EX	A58	B55	0,9	F54
Class M (W163)	ML 320 (163.154)	M 112.942	160/218	02.1998	08.2002		FN 42 LZDPR5	A195		1,05	
	ML 350 4-matic	M 112.970	173/235	02.2003	06.2005		FN 42 LZDPR5	A195		1,05	
	ML 350 (163.157)	M 112.970	180/245	08.2002	06.2005		FN 42 LZDPR5	A195		1,05	
	ML 430 (163.172)	M 113.942	200/272	02.1998	06.2005		FN 42 LZDPR5	A195		1,05	
	ML 500 (163.175)	M 113.964 - M 113.965	215/292	09.2001	06.2005		FN 42 LZDPR5	A195		1,05	
	ML 55 AMG (163.174)	M 113.981	255/347	02.2000	06.2005		FN 42 LZDPR5	A195		1,05	
	ML 350 4-matic (164.186)	M 272.967	200/272	07.2005	12.2011		ZN 68 HSTDPR	A527		0,8	
	ML 500 4-matic (164.175)	M 113.964	225/306	07.2005	12.2011		FN 42 LZDPR5	A195		1,05	
Class M (W164)	ML 500 4-matic (164.172)	M 273.963	285/388	12.2007	12.2011		ZN 68 HSTDPR	A527		0,8	
	R 280 (251.054, 251.154)	M 272.945	170/231	01.2007			ZN 68 HSTDPR	A527		0,8	
	R 280 4-matic (251.062)	M 272.945	170/231	05.2007			ZN 68 HSTDPR	A527		0,8	
Class R (W251, V251)	R 300 (251.054, 251.154)	M 272.945	170/231	07.2009			ZN 68 HSTDPR	A527		0,8	
	R 350 (251.056, 251.156)	M 272.967	200/272	01.2007			ZN 68 HSTDPR	A527		0,8	
	R 350 4-matic (251.065, 251.165)	M 272.967	200/272	01.2006			ZN 68 HSTDPR	A527	0,8		
	R 500 4-matic (251.075, 251.175)	M 113.971	225/306	01.2006			FN 42 LZDPR5	A195		1,05	
	R 500 4-matic (251.072, 251.172)	M 273.963	285/388	01.2007			ZN 68 HSTDPR	A527		0,8	
	200 TE Kombi 2.0 (S124)	M 111.940	100/136	10.1992	06.1993		FC 42 LS	A15	B14	0,8	F54
	220 TE Kombi 2.2 (S124)	M 111.960	110/150	10.1992	05.1993		FC 42 LS	A15	B14	0,8	F54
	300 : 3.0 TE [S124] Kombi	M 104.980	162/220	09.1989	08.1992		FC 42 LS	A15	B14	0,8	F54
	Class S (W108, W109)	250 S (108.012)	M 108.920	96/130	01.1966	12.1969		FC 42 LS	A15	B14	0,8
250 SE (108.014)		M 129.980	110/150	01.1966	12.1967		C 82 LS	A40	B6	0,8	L87
280 S (108.016)		M 130.920	103/140	10.1967	07.1972		C 82 LS	A40	B6	0,8	L87
280 SE, SEL (108.018, 108.019)		M 130.980	118/160	01.1968	08.1972		RC 72 LS	A32	B26	0,7	L87

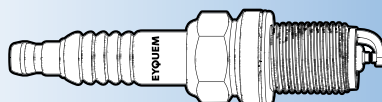

(1) Available until end of stock

(a) 30 000 km

(b) 60 000 km

(c) Grey sticker on ignition coil

(d) Green sticker on ignition coil

(e) Hex 21 mm

(f) Hex 16 mm

(g) Recommended for cold weather



KW/HP



Box 10
Blister 4



F3-1

MERCEDES

	300 SEL (109.016)	M 130.981	118/160	01.1968	08.1972	RC 72 LS	A32	B26	0,7	L87	
	280 SE, SEL 3.5 (108.058)	M 116.981	147/200	01.1970	07.1972	RC 82 LS	A78		0,8	L87	
	300 SEL 6.3 (109.018)	M 100.981	184/250	03.1968	08.1972	RC 62 LS	A6	B17	0,8	L65	
Class S (W116)	280 S (116.020)	M 110.922	115/156	08.1972	12.1975	C 62 LS	A4	B5	0,8	L65	
	280 S (116.020)	M 110.922	115/156	01.1976	07.1980	C 52 LS	A1	B1	0,8	L65	
	280 S (116.020)	M 110.922	118/160	08.1972	12.1975	C 62 LS	A4	B5	0,8	L65	
	280 S (116.020)	M 110.922	118/160	01.1976	07.1980	C 52 LS	A1	B1	0,8	L65	
	280 SE, SEL (116.024)	M 110.985	130/177	08.1972	07.1976	C 62 LS	A4	B5	0,8	L65	
	280 SE, SEL (116.024)	M 110.985	130/177	08.1976	07.1980	C 52 LS	A1	B1	0,8	L65	
	280 SE, SEL (116.024)	M 110.983	136/185	08.1972	07.1976	C 62 LS	A4	B5	0,8	L65	
	280 SE, SEL (116.024)	M 110.983	136/185	08.1976	07.1980	C 52 LS	A1	B1	0,8	L65	
	350 SE, SEL (116.028, 116.029)	M 116.985	143-152/194-207	03.1976	03.1980	C 62 LS	A4	B5	0,8	L65	
	350 SE, SEL (116.028, 116.029)	M 116.983	147/200	08.1972	02.1976	C 62 LS	A4	B5	0,8	L65	
	350 SE, SEL (116.028, 116.029)	M 116.985	151/205	03.1976	03.1980	C 62 LS	A4	B5	0,8	L65	
	450 SE	M 117.983	143/194	08.1972	12.1976	RC 72 LS	A32	B26	0,7	L87	
	450 SE, SEL (116.033)	M 117.986 - M 117.983	160-167/218-227	12.1975	04.1980	C 52 LS	A1	B1	0,8	L65	
	450 SE, SEL (116.032)	M 117.986 - M 117.983	165/224	01.1973	11.1975	C 62 LS	A4	B5	0,8	L65	
450 SE, SEL (116.032)	M 117.986 - M 117.983	165/224	12.1975	04.1980	C 52 LS	A1	B1	0,8	L65		
450 SEL 6.9 (116.036)	M 100.985	210-212/286-288	07.1975	03.1980	C 62 LS	A4	B5	0,8	L65		
	(high compression)										
	450 SEL 6.9 (116.036)	M 100.985	210-212/286-288	07.1975	03.1980	C 52 LS	A1	B1	0,8	L65	
	(low compression)										
Class S (W126)	260 SE (126.020)	M 103.941	118/160	09.1985	06.1991	C 52 LJS	A23		0,8	J65	
	260 SE (126.020)	M 103.941	122/166	09.1985	06.1991	C 52 LJS	A23		0,8	J65	
	280 S (126.021)	M 110.924 - M 110.926	115/156	12.1979	07.1985	C 62 LS	A4	B5	0,8	L65	
		(high compression)									
	280 S (126.021)	M 110.924 - M 110.926	115/156	12.1979	07.1985	C 52 LS	A1	B1	0,8	L65	
		(low compression)									
	280 SE, SEL (126.022, 126.023)	M 110.987 - M 110.989	136/185	10.1979	07.1985	C 62 LS	A4	B5	0,8	L65	
		(high compression)									
	280 SE, SEL (126.022, 126.023)	M 110.987 - M 110.989	136/185	10.1979	07.1985	C 52 LS	A1	B1	0,8	L65	
		(low compression)									
	300 SE, SEL (126.024, 126.025)	M 103.981	132-138/180-188	09.1985	02.1987	C 62 LJS	A19	B2	0,8	J65	
	300 SE, SEL (126.024, 126.025)	M 103.981	132-138/180-188	03.1987	06.1991	C 52 LJS	A23		0,8	J65	
	3.8	M 116.961	160/218	08.1980	08.1984	C 62 LS	A4	B5	0,8	L65	
	380 SE, SEL (126.032)	M 116.963	150/204	10.1980	08.1985	C 62 LS	A4	B5	0,8	L65~	
		(high compression)									
	380 SE, SEL (126.032)	M 116.963	150/204	10.1980	08.1985	C 52 LS	A1	B1	0,8	L65	
		(high compression)									
	380 SE, SEL (126.032)	M 116.961	160/218	09.1980	10.1981	C 62 LS	A4	B5	0,8	L65	
	420 SE, SEL (126.034, 126.035)	M 116.965	150/204	09.1985	06.1991	C 62 LS	A4	B5	0,8	L65	
		(high compression)									
	420 SE, SEL (126.034, 126.035)	M 116.965	150/204	09.1985	06.1991	C 52 LS	A1	B1	0,8	L65	
		(low compression)									
	420 SE, SEL (126.034)	M 116.965	160/218	10.1985	12.1987	C 62 LS	A4	B5	0,8	L65	
		(high compression)									
420 SE, SEL (126.034)	M 116.965	160/218	10.1985	12.1987	C 52 LS	A1	B1	0,8	L65		
	(low compression)										
420 SE, SEL	M 116.965	165/224	10.1985	06.1991	C 62 LS	A4	B5	0,8	L65		
	(high compression)										
420 SE, SEL	M 116.965	165/224	10.1985	06.1991	C 52 LS	A1	B1	0,8	L65		
	(low compression)										
420 SE, SEL	M 116.965	170/231	10.1985	12.1987	C 62 LS	A4	B5	0,8	L65		
	(high compression)										
420 SE, SEL	M 116.965	170/231	10.1985	12.1987	C 52 LS	A1	B1	0,8	L65		
	(low compression)										
500 SE, SEL (126.036)	M 116.965	164/223	12.1979	08.1985	C 62 LS	A4	B5	0,8	L65		
	(high compression)										
500 SE, SEL (126.036)	M 116.965	164/223	12.1979	08.1985	C 52 LS	A1	B1	0,8	L65		
	(low compression)										
500 SE, SEL (126.036)	M 117.961-117.963	170-177-180/ 231-241-245	12.1979	08.1985	C 62 LS	A4	B5	0,8	L65		
	(high compression)										
500 SE, SEL (126.036)	M 117.961-117.963	170-177-180/ 231-241-245	12.1979	08.1985	C 52 LS	A1	B1	0,8	L65		
	(low compression)										

(1) Available until end of stock

(a) 30 000 km

(b) 60 000 km

(c) Grey sticker on ignition coil

(d) Green sticker on ignition coil

(e) Hex 21 mm

(f) Hex 16 mm

(g) Recommended for

cold weather



EYQUEM



Box 10
Blister 4



F3

MERCEDES

	500 SE, SEL CAT	M 117.965 (high compression)	185/252	09.1987	06.1991	C 62 LS	A4	B5	0,8	L65
	500 SE, SEL CAT	M 117.965 (low compression)	185/252	09.1987	06.1991	C 52 LS	A1	B1	0,8	L65
	500 SE, SEL	M 117.965 (high compression)	195/265	09.1987	06.1991	C 62 LS	A4	B5	0,8	L65
	500 SE, SEL	M 117.965 (low compression)	195/265	09.1987	06.1991	C 52 LS	A1	B1	0,8	L65
	560 SE, SEL (126.038, 126.039)	M 117.968 Cat (high compression)	178/242	09.1987	06.1991	C 62 LS	A4	B5	0,8	L65
	560 SE, SEL (126.038, 126.039)	M 117.968 Cat (low compression)	178/242	09.1987	06.1991	C 52 LS	A1	B1	0,8	L65
	560 SE, SEL (126.038)	M 117.968 (high compression)	200/272	10.1985	06.1991	C 62 LS	A4	B5	0,8	L65
	560 SE, SEL (126.038)	M 117.968 (low compression)	200/272	10.1985	06.1991	C 52 LS	A1	B1	0,8	L65
	560 SE, SEL	M 117.968 (high compression)	205/279	09.1987	06.1991	C 62 LS	A4	B5	0,8	L65
	560 SE, SEL	M 117.968 (low compression)	205/279	09.1987	06.1991	C 52 LS	A1	B1	0,8	L65
	560 SE, SEL	M 117.968 (high compression)	220/300	10.1985	06.1991	C 62 LS	A4	B5	0,8	L65
	560 SE, SEL	M 117.968 (low compression)	220/300	10.1985	06.1991	C 52 LS	A1	B1	0,8	L65
Class S (W140)	S 280 (140.028)	M 104.944	142/193	02.1993	10.1998	FC 42 LS	A15	B14	0,8	F54
	300 SE 2.8 (140.028)	M 104.944	145/197	01.1993	10.1998	FC 42 LS	A15	B14	0,8	F54
	300 SE, SEL/320 (140.032, 140.033)	M 104.990- M 104.994	170/231	03.1991	10.1998	FC 42 LS	A15	B14	0,8	F54
	S 420 (140.042)	M 119.971	205/279	03.1993	06.1997	FC 42 LS	A15	B14	0,8	F54
	400 SE, SEL/S420 (140.042, 140.043)	M 119.971- M 119.981 Engine n°->011673	210/286	02.1991	05.1993	RFC 42 LS	A25		0,8	F54
	400 SE, SEL/S420 (140.042, 140.043)	M 119.971- M 119.981 Engine n° 011674 ->	210/286	06.1993	09.1998	FN 42 LZDPR5	A195		1,05	
	S 500 (140.050, 140.051)	M 119.970	235/320	07.1993	06.1997	RFC 42 LS	A25		0,8	F54
	S 500 SE, SEL (140.050, 140.051)	M 119.970	240/326	07.1993	06.1997	RFC 42 LS	A25		0,8	F54
	S 600 (140.056, 140.057)	M 120.980	290/394	07.1993	06.1997	RFC 42 LS	A25		0,8	F54
	S 600 SE, SEL (140.056, 140.057)	M 120.980 - M 120.982	300/408	04.1991	12.1992	FC 42 LS	A15	B14	0,8	F54
Class S (W220)	S 280 (220.063, 200.163)	M 112.922	150/204	01.1999	08.2005	FN 42 LZDPR5	A195		1,05	
	S 320 (220.065, 22.165)	M 112.944	165/224	02.2002	08.2005	FN 42 LZDPR5	A195		1,05	
	S 350 (220.067, 222.167)	M 112.972	180/245	09.2002	08.2005	FN 42 LZDPR5	A195		1,05	
	S 350 4-matic (220.087, 222.187)	M 112.972	180/245	06.2003	08.2005	FN 42 LZDPR5	A195		1,05	
	S 430 (220.070, 220.170)	M 113.941	205/279	02.2002	08.2005	FN 42 LZDPR5	A195		1,05	
	S 430 4-matic (220.083, 220.183)	M 113.948	205/279	09.2002	08.2005	FN 42 LZDPR5	A195		1,05	
	S 430 4-matic (220.083, 220.183)	M 113.948	205/279	09.2002	08.2005	FN 42 LZDPR5	A195		1,05	
	S 500 (220.075, 220.175)	M 113.960	225/306	02.2002	08.2005	FN 42 LZDPR5	A195		1,05	
	S 500 4-matic (220.084, 220.184)	M 113.966	225/306	09.2002	08.2005	FN 42 LZDPR5	A195		1,05	
	S 600 (220.878, 220.178)	M 137.970	270/367	01.2000	08.2005	RFN 58 LZDP5	A187		1,1	
	S 55 AMG (220.073, 220.173)	M 113.986	265/360	02.2002	08.2005	FN 42 LZDPR5	A195		1,05	
	S 55 AMG Kompressor (220.074, 220.174)	M 113.991	368/500	06.2002	08.2005	RFN 62 HZDP	A504		0,8	
	Class S (W221)	S 280 (221.054)	M 272.946	170/231	08.2006	12.2013	ZN 68 HSTDPR	A527		0,8
S 300 (221.054)		M 272.946	170/231	08.2006	12.2013	ZN 68 HSTDPR	A527		0,8	
S 350 (221.056, 221.156)		M 272.965	200/272	10.2005	12.2013	ZN 68 HSTDPR	A527		0,8	
S 350 4-matic (221.087, 221.187)		M 272.965	200/272	02.2008	12.2013	ZN 68 HSTDPR	A527		0,8	
S 400 Hybrid (221.095, 221.195)		M 272.974	205/279	01.2009	12.2013	ZN 68 HSTDPR	A527		0,8	
S 450 (221.070, 221.170)		M273.922	250/340	12.2005	12.2013	ZN 68 HSTDPR	A527		0,8	
S 450 4-matic (221.084, 221.184)		M273.924	250/340	12.2005	12.2013	ZN 68 HSTDPR	A527		0,8	
S 500 (221.071, 221.171)		M273.961	285/388	10.2005	12.2013	ZN 68 HSTDPR	A527		0,8	
S 500 4-matic (221.086, 221.186)		M273.961	285/388	10.2005	12.2013	ZN 68 HSTDPR	A527		0,8	
Class S Coupé (C126)	380 SEC (126.043)	M 116.963 (high compression)	150/204	10.1980	07.1985	C 62 LS	A4	B5	0,8	L65
	380 SEC (126.043)	M 116.963 (low compression)	150/204	10.1980	07.1985	C 52 LS	A1	B1	0,8	L65
	380 SEC (126.043)	M 116.961 (high compression)	160/218	08.1980	12.1981	C 62 LS	A4	B5	0,8	L65

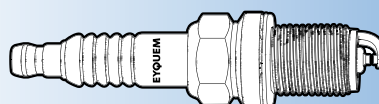

(1) Available until end of stock

- (a) 30 000 km
- (b) 60 000 km
- (c) Grey sticker on ignition coil
- (d) Green sticker on ignition coil

- (e) Hex 21 mm
- (f) Hex 16 mm
- (g) Recommended for cold weather



KW/HP



Box
10

Blister
4



F3-1

MERCEDES

	380 SEC (126.043)	M 116.961 (low compression)	160/218	08.1980	12.1981	C 52 LS	A1	B1	0,8	L65
	420 SEC (126.046)	M 116.965 (high compression)	150-170/204-231	10.1985	06.1991	C 62 LS	A4	B5	0,8	L65
	420 SEC (126.046)	M 116.965 (low compression)	150-170/204-231	10.1985	06.1991	C 52 LS	A1	B1	0,8	L65
	420 SEC (126.046)	M 116.965 (high compression)	160/218	10.1985	12.1987	C 62 LS	A4	B5	0,8	L65
	420 SEC (126.046)	M 116.965 (low compression)	160/218	10.1985	12.1987	C 52 LS	A1	B1	0,8	L65
	420 SEC (126.046)	M 116.965 (high compression)	165/224	10.1985	06.1991	C 62 LS	A4	B5	0,8	L65
	420 SEC (126.046)	M 116.965 (low compression)	165/224	10.1985	06.1991	C 52 LS	A1	B1	0,8	L65
	500 SEC (126.044)	M 117.965 (high compression)	164/223	10.1985	06.1991	C 62 LS	A4	B5	0,8	L65
	500 SEC (126.044)	M 117.965 (low compression)	164/223	10.1985	06.1991	C 52 LS	A1	B1	0,8	L65
	500 SEC (126.044)	M 117.963 (high compression)	170-177-180/ 231-241-245	10.1985	06.1991	C 62 LS	A4	B5	0,8	L65
	500 SEC (126.044)	M 117.963 (low compression)	170-177-180/ 231-241-245	10.1985	06.1991	C 52 LS	A1	B1	0,8	L65
	500 SEC (126.044)	M 117.965 (high compression)	185/252	08.1987	06.1991	C 62 LS	A4	B5	0,8	L65
	500 SEC (126.044)	M 117.965 (low compression)	185/252	08.1987	06.1991	C 52 LS	A1	B1	0,8	L65
	500 SEC CAT	M 117.965 (high compression)	185/252	06.1989	06.1991	C 62 LS	A4	B5	0,8	L65
	500 SEC CAT	M 117.965 (low compression)	185/252	06.1989	06.1991	C 52 LS	A1	B1	0,8	L65
	500 SEC (126.044)	M 117.965 (high compression)	195/265	09.1985	06.1991	C 62 LS	A4	B5	0,8	L65
	500 SEC (126.044)	M 117.965 (low compression)	195/265	09.1985	06.1991	C 52 LS	A1	B1	0,8	L65
	560 SEC (126.045)	M 117.968 (high compression)	178-200/242-272	10.1985	06.1991	C 62 LS	A4	B5	0,8	L65
	560 SEC (126.045)	M 117.968 (low compression)	178-200/242-272	10.1985	06.1991	C 52 LS	A1	B1	0,8	L65
	560 SEC (126.045)	M 117.968 (high compression)	205-220/279-300	10.1985	06.1991	C 62 LS	A4	B5	0,8	L65
	560 SEC (126.045)	M 117.968 (low compression)	205-220/279-300	10.1985	06.1991	C 52 LS	A1	B1	0,8	L65
Class S Coupé (C140)	SEC/CL 420 (140.063)	M 119.971 Engine n°->011673	205/279	10.1994	06.1997	RFC 42 LS	A25		0,8	F54
	SEC/CL 420 (140.063)	M 119.981 Engine n° 011674 ->	210/286	07.1997	02.1999	FN 42 LZDPR5	A195		1,05	
	SEC/CL 500 (140.070)	M 119.970-119.980	235/320	06.1993	06.1997	RFC 42 LS	A25		0,8	F54
	SEC/CL 600 (140.076)	M 120.980	290/394	09.1992	05.1996	RFC 42 LS	A25		0,8	F54
	SEC/CL 600 (140.076)	M 120.982 Engine n° 008360->	290/394	06.1996	02.1999	FN 42 LZDPR5	A195		1,05	
Class S Coupé (C215)	CL 500 Coupe (215.375)	M 113.960	225/306	09.1999	03.2006	FN 42 LZDPR5	A195		1,05	
	CL 55 AMG Coupe (215.373)	M 113.986	265/360	02.2002	03.2006	FN 42 LZDPR5	A195		1,05	
	CL 55 AMG Kompressor (215.374)	M 113.991	368/500	06.2002	03.2006	RFN 62 HZDP	A504		0,8	
Class S Coupé (C216)	CL 500 (216.371)	M 273.961	285/388	06.2006	12.2013	ZN 68 HSTDPR	A527		0,8	
	CL 500 4-matic (216.386)	M273.968	285/388	02.2008	12.2013	ZN 68 HSTDPR	A527		0,8	
Class V (638/2)	V 200 (638.214, 638.294)	M 111.948 - M111.950	95-100/129-136	04.1996	07.2003	RFC 42 LZ2E	A5	B30	1,0	F54
	V 230 (638.234, 638.294)	M 111.978	105/143	04.1996	07.2003	RFC 42 LZ2E	A5	B30	1,0	F54
	V 280 (638.244, 638.294)	M 104.900	128/174	08.1997	07.2003	RFC 42 LZ4E	A154		1,6	
	V 280 (638.244, 638.294) GPL	M 104.900	128/174	04.1996	07.2003	RFC 52 LZ4E	A159		1,6	
CLK (C208)	200 (208.335)	M 111.945 engine n°->052061	100/136	06.1997	06.2002	RFC 42 LS	A25		0,8	F54
	200 (208.335)	M 111.945 engine n° 052062 ->	100/136	06.1997	06.2002	RFC 58 LZ3EX	A58	B55	0,9	F54
	200 Kompressor (208.344)	M 111.956	120/163	06.1997	04.2002	RFN 58 LZDP5	A187		1,1	
	200 Kompressor (208.345)	M 111.944	141/192	06.1997	02.2000	RFC 58 LZ3EX	A58	B55	0,9	F54

(1) Available until end of stock

(a) 30 000 km

(b) 60 000 km

(c) Grey sticker on ignition coil

(d) Green sticker on ignition coil

(e) Hex 21 mm

(f) Hex 16 mm

(g) Recommended for

cold weather



EYQUEM



Box
10

Blister
4



F3

MERCEDES

	230 Kompressor (208.348)	M 111.982	145/197	06.2000	04.2002	RFN 58 LZDP5	A187		1,1	
	320 (208.365)	M 112.940	160/218	06.1997	06.2002	FN 42 LZDPR5	A195		1,05	
	430 (208.370)	M 113.943	205/279	07.1998	04.2002	FN 42 LZDPR5	A195		1,05	
	55 AMG (208.374)	M 113.981- M 113.984	255/347	08.1999	06.2002	FN 42 LZDPR5	A195		1,05	
CLK (C209)	200 Kompressor (209.342)	M 271.940	120/163	09.2002	11.2006	RFN 62 HZDP	A504		0,8	
		engine n°->30853899								
	200 Kompressor (209.342)	M 271.940	120/163	12.2006	05.2009	ZN 68 HSTDPR	A527		0,8	
		engine n° 30853900 ->								
	200 CGI (209.343)	M 271.942	125/170	07.2003	04.2005	RFN 62 HZDP	A504		0,8	
	200 CGI (209.343)	M 271.942	125/170	05.2005	05.2009	ZN 68 HSTDPR	A527		0,8	
		engine n° 30853900 ->								
	200 Kompressor (209.341)	M 271.955	135/184	10.2006	11.2006	RFN 62 HZDP	A504		0,8	
		engine n°->30853899								
	200 Kompressor (209.341)	M 271.955	135/184	12.2006	05.2009	ZN 68 HSTDPR	A527		0,8	
		engine n° 30853900 ->								
	240 (209.361)	M 112.912	125/170	06.2002	05.2009	FN 42 LZDPR5	A195		1,05	
	280 (209.354)	M 272.940	170/231	01.2005	05.2009	ZN 68 HSTDPR	A527		0,8	
	320 (209.365)	M 112.955	160/218	06.2002	05.2009	FN 42 LZDPR5	A195		1,05	
	350 (209.356)	M 272.960	200/272	01.2005	05.2009	ZN 68 HSTDPR	A527		0,8	
	500 (209.375)	M 113.968	225/306	06.2002	05.2009	FN 42 LZDPR5	A195		1,05	
	500 (209.372)	M 273.965	285/388	06.2006	05.2009	ZN 68 HSTDPR	A527		0,8	
	55 AMG (209.376)	M 113.987	270/367	09.2002	08.2006	RFN 58 LZDP5	A187		1,1	
CLK Cabriolet (A208)	200 (208.435)	M 111.945	100/136	03.1998	03.2002	RFC 42 LS	A25		0,8	F54
		engine n°->052061								
	200 (208.435)	M 111.945	100/136	03.1998	03.2002	RFC 58 LZ3EX	A58	B55	0,9	F54
		engine n° 052062 ->								
	200 Kompressor (208.444)	M 111.956	120/163	06.2000	03.2002	RFN 58 LZDP5	A187		1,1	
	200 Kompressor (208.445)	M 111.944	141/192	03.1998	06.2000	RFC 58 LZ3EX	A58	B55	0,9	F54
	230 Kompressor (208.447)	M 111.975	142/193	03.1998	06.2000	RFC 58 LZ3EX	A58	B55	0,9	F54
	230 Kompressor (208.448)	M 111.982	145/197	06.2000	03.2002	RFN 58 LZDP5	A187		1,1	
	320 (208.465)	M 112.940	160/218	03.1998	03.2002	FN 42 LZDPR5	A195		1,05	
	430 (208.470)	M 113.943	205/279	09.1998	03.2002	FN 42 LZDPR5	A195		1,05	
	55 AMG (208.474)	M 113.981- M 113.984	255/347	01.2000	03.2002	FN 42 LZDPR5	A195		1,05	
CLK Cabriolet (A209)	200 Kompressor (209.442)	M 271.940	120/163	02.2003	11.2006	RFN 62 HZDP	A504		0,8	
		engine n°->30853899								
	200 Kompressor (209.442)	M 271.940	120/163	12.2006	03.2010	ZN 68 HSTDPR	A527		0,8	
		engine n° 30853900 ->								
	200 Kompressor (209.441)	M 271.955	135/184	10.2006	08.2007	RFN 62 HZDP	A504		0,8	
		engine ->30099998								
	200 Kompressor (209.441)	M 271.955	135/184	08.2007	03.2010	ZN 68 HSTDPR	A527		0,8	
		engine n° 30099999 ->								
	200 CGI (209.443)	M 271.942	125/170	07.2003	05.2005	RFN 62 HZDP	A504		0,8	
		engine n°->30853899								
	200 CGI (209.443)	M 271.942	125/170	05.2005	03.2010	ZN 68 HSTDPR	A527		0,8	
		engine n° 30853900 ->								
	240 Cabriolet (A209)	M 112.912	125/170	02.2003	03.2010	FN 42 LZDPR5	A195		1,05	
	280 (209.454)	M 272.940	170/231	01.2005	03.2010	ZN 68 HSTDPR	A527		0,8	
	320 Cabriolet (209.465)	M 112.955	160/218	02.2003	03.2010	FN 42 LZDPR5	A195		1,05	
	350 (209.456)	M 272.960	200/272	01.2005	03.2010	ZN 68 HSTDPR	A527		0,8	
	500 (209.475)	M 113.968	225/306	02.2003	03.2010	FN 42 LZDPR5	A195		1,05	
	500 (209.472)	M 273.967	285/388	06.2006	03.2010	ZN 68 HSTDPR	A527		0,8	
	55 AMG (209.476)	M 113.987	270/367	02.2003	08.2006	RFN 58 LZDP5	A187		1,1	
CLS (C219)	280 (219.354)	M 272.943	170/231	07.2008	12.2010	ZN 68 HSTDPR	A527		0,8	
	300 (219.354)	M 272.943	170/231	04.2009	12.2010	ZN 68 HSTDPR	A527		0,8	
	350 (219.356)	M 272.964	200/272	10.2004	12.2010	ZN 68 HSTDPR	A527		0,8	
	500 (219.375)	M 113.967	225/306	10.2004	12.2010	FN 42 LZDPR5	A195		1,05	
	500 (219.372)	M 273.960	285/388	04.2006	12.2010	ZN 68 HSTDPR	A527		0,8	
	55 AMG (219.376)	M 113.990	350/476	01.2005	12.2010	RFN 62 HZDP	A504		0,8	
Coupé (W111)	220 SEB (111.021)	M 127.984	88/120	01.1961	12.1965	C 82 LS	A40	B6	0,8	L87
	250 SE (111.021)	M 129.980 - M129.981	110/150	01.1965	12.1967	C 82 LS	A40	B6	0,8	L87
	280 SE (111.024)	M 130.980 - M 130.984	118/160	01.1967	12.1971	RC 82 LS	A78		0,8	L87
	280 SE 3.5 (111.026)	M 116.980	147/200	01.1969	12.1971	RC 82 LS	A78		0,8	L87
GULLWING (W198)	300 SL (198.040)	M 198.980	143/195	09.1954	09.1957	RC 82 L	A94		0,7	
	300 SL (198.040)	M 198.980	158/215	09.1954	05.1957	RC 82 L	A94		0,7	
HECKFLOSSE (W110)	190 C	M 121.924	59/80	04.1961	08.1965	RC 72 LS	A32	B26	0,8	L87

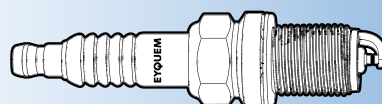

(1) Available until end of stock

- (a) 30 000 km
- (b) 60 000 km
- (c) Grey sticker on ignition coil
- (d) Green sticker on ignition coil

- (e) Hex 21 mm
- (f) Hex 16 mm
- (g) Recommended for cold weather



Box 10
Blister 4



F3→1

MERCEDES

	200	M 121.940	61/83	07.1965	02.1968	RC 62 LS	A6	B17	0,8	L65
	200	M 115.926	70/95	07.1965	02.1968	RC 72 LS	A32	B26	0,8	L87
	230	M 180.945 - M 180.949	77/105	07.1965	02.1968	RC 72 LS	A32	B26	0,8	L87
	230	M 180.950	88/120	06.1966	12.1967	C 62 LS	A4	B5	0,8	L65
HECKFLOSSE (W111, W112)	220 B (111.010)	M 180.940	70/95	08.1959	08.1965	RC 72 LS	A32	B26	0,7	L87
	220 SB (111.012)	M 180.941	81/110	08.1959	08.1965	RC 72 LS	A32	B26	0,7	L87
	220 SEB (111.014)	M 127.982	88/120	08.1959	08.1965	C 82 LS	A40	B6	0,8	L87
	230 S (111.010)	M 180.947 - M 180.950	88/120	07.1965	01.1968	RC 82 LS	A78		0,8	L87
	300 SE (112.014, 112.015)	M 189.984 - M 189.986	118/160	02.1961	02.1964	RC 82 LS	A78		0,8	L87
	300 SE (112.021, 112.023)	M 189.985 - M 189.987	125/170	02.1964	07.1965	RC 82 LS	A78		0,8	L87
L, LF, LM	L 207, L 307 : 2.0	Austin A70	51/69	03.1973	07.1977	C 62 LS	A4	B5	0,8	L65
	L 409 : 2.3	M 115.952	66/90	01.1975	08.1982	C 62 LS	A4	B5	0,8	L65
	L 410 : 2.3	M 102.943	70/95	08.1982	12.1988	C 52 LJS	A23		0,8	J65
	LF 409 G : 2.3	M 115.970	66/90	01.1975	08.1982	C 62 LS	A4	B5	0,8	L65
	LK 409 : 2.3	M 115.952	66/90	01.1975	08.1982	C 62 LS	A4	B5	0,8	L65
	LM 409 : 2.3	M 115...	60-66/82-90	01.1975		C 62 LS	A4	B5	0,8	L65
Model 100	600 : 6.3 SE, SEL	M 100.980 - M 100.982	162-184/220-250	09.1964	05.1981	C 62 LS	A4	B5	0,8	L65
Model 123 (W123)	200	M 115.938	62-69/84-94	02.1976	08.1980	C 52 LS	A1	B1	0,8	L65
		(low compression)								
	200	M 115.938 - M 115.939	62-69/84-94	02.1976	08.1980	C 62 LS	A4	B5	0,8	L65
	200	M 102.920 - M 102.939	74-80/100-109	06.1980	11.1985	C 62 LJS	A19	B2	0,8	J65
	200	M 102.920 - M 102.939	74-80/100-109	11.1980	11.1985	C 52 LJS	A23		0,8	J65
		(low compression)								
	230 (123.023)	M 115.954	80/109	02.1976	03.1981	C 52 LS	A1	B1	0,8	L65
	230 E (123.223)	M 102.980	100/136	04.1980	12.1985	C 62 LJS	A19	B2	0,8	J65
	250 (123.026)	M 123.921	95/129	02.1976	10.1979	RC 72 LS	A32	B26	0,8	L87
	250 (123.026)	M 123.921	103/140	10.1979	07.1985	RC 72 LS	A32	B26	0,8	L87
	280 (123.030)	M 110.923	115/156	02.1976	08.1981	C 52 LS	A1	B1	0,8	L65
	280 E, TE (123.033)	M 110.984 - M 110.988	130-136/177-185	02.1976	11.1985	C 62 LS	A4	B5	0,8	L65
Model 123 Break (S123)	200 T (123.280)	M 102.939	74/101	11.1980	11.1985	C 62 LJS	A19	B2	0,8	J65
	200 T	M 102.920	80/109	11.1980	11.1985	C 62 LJS	A19	B2	0,8	J65
	230 T (123.083)	M 115.954	80/109	09.1977	03.1980	C 52 LS	A1	B1	0,8	L65
	230 TE (123.283)	M 102.980	110/136	04.1980	11.1985	C 62 LJS	A19	B2	0,8	J65
	250 T (123.086)	M 123.921	95/129	05.1978	10.1979	RC 72 LS	A32	B26	0,8	L87
	250 T (123.086)	M 123.921	103/140	05.1978	08.1982	RC 72 LS	A32	B26	0,8	L87
	280 TE (123.093)	M 110.988	136/185	09.1977	11.1985	C 52 LS	A1	B1	0,8	L65
Model 123 Coupé (C123)	230 C (123.043)	M 115.954	80/109	05.1977	04.1980	C 52 LS	A1	B1	0,8	L65
	230 CE (123.243)	M 102.980	100/136	04.1980	12.1985	C 62 LJS	A19	B2	0,8	J65
	280 C (123.050)	M 110.923	115/156	03.1977	03.1980	C 62 LS	A4	B5	0,8	L65
	280 CE	M 110.988	130/177	09.1977	08.1979	C 52 LS	A1	B1	0,8	L65
		low compression								
	280 CE	M 110.988	130/177	09.1977	08.1979	C 62 LS	A4	B5	0,8	L65
	280 CE	M 110.988	136/185	03.1977	11.1985	C 52 LS	A1	B1	0,8	L65
		low compression								
	280 CE	M 110.988	136/185	03.1977	11.1985	C 62 LS	A4	B5	0,8	L65
Model 124 (W124)	200 (124.020)	M 102.922 Cat	75-77-80/ 102-105-109	12.1984	05.1990	C 52 LJS	A23		0,8	J65
	200 E (124.021)	M 102.963	87/118	09.1988	08.1992	C 62 LJS	A19	B2	0,8	J65
	200 E (124.021)	M 102.963	90/122	09.1989	06.1993	C 62 LJS	A19	B2	0,8	J65
	200 E (124.019)	M 111.940	100/136	09.1992	06.1993	FC 42 LS	A15	B14	0,8	F54
	220 E (124.022)	M 111.960	110/150	10.1992	06.1993	FC 42 LS	A15	B14	0,8	F54
	230 E (124.023)	M 102.982	97/132	06.1989	06.1993	C 62 LJS	A19	B2	0,8	J65
	230 E (124.023)	M 102.982 Cat	90-100/122-136	12.1984	08.1992	C 52 LJS	A23		0,8	J65
	230 E (124.023)	M 102.982	90-100/122-136	09.1992	06.1993	C 62 LJS	A19	B2	0,8	J65
	260 E (124.026)	M 103.940 Cat	118-122/160-166	09.1985	08.1992	C 52 LJS	A23		0,8	J65
	260 E 4-matic (124.226)	M 103.943	118-122/160-166	09.1986	08.1992	C 52 LJS	A23		0,8	J65
	280 E (124.028)	M 104.942	145/197	09.1992	06.1993	FC 42 LS	A15	B14	0,8	F54
	300 E (124.030)	M 103.983	132-138/180-188	09.1985	06.1993	C 52 LJS	A23		0,8	J65
	300 E 4-matic (124.230)	M 103.985	132-138/180-188	09.1986	06.1993	C 52 LJS	A23		0,8	J65
	300 E	M 103.980	138/188	01.1985	08.1985	C 62 LJS	A19	B2	0,8	J65
	300 E	M 103.983	138/188	06.1985	06.1992	C 52 LJS	A23		0,8	J65
	300 E 4-matic	M 103.983	138/188	09.1986	02.1992	C 52 LJS	A23		0,8	J65

(f) Available until end of stock

(a) 30 000 km

(b) 60 000 km

(c) Grey sticker on ignition coil

(d) Green sticker on ignition coil

(e) Hex 21 mm

(f) Hex 16 mm

(g) Recommended for cold weather



EYQUEM



Box 10
Blister 4



F3 → 1

MERCEDES

	300 E 24 (124.031)	M 104.980	162/220	09.1988	08.1992	FC 42 LS	A15	B14	0,8	F54
	320 E (124.032)	M 104.992	162/220	10.1992	06.1993	FC 42 LS	A15	B14	0,8	F54
	400 E (124.034)	M 119.975	205-210/279-286	10.1992	06.1993	FC 42 LS	A15	B14	0,8	F54
	500 E (124.036)	M 119.974	235-240/320-326	01.1991	06.1993	FC 42 LS	A15	B14	0,8	F54
	500 E AMG 6.0 (124.036)	M 119.974 (AMG 6.0)	275/374	01.1992	06.1993	FC 42 LS	A15	B14	0,8	F54
Série O	O 309 : 2.3	M 102.943	70/95	08.1982	02.1989	C 52 LJS	A23		0,8	J65
	O 309 B : 2.3	M 115.928	55/75	08.1972	12.1974	C 62 LS	A4	B5	0,8	L65
	O 309 B : 2.3	M 115.952	66/90	01.1975	08.1982	C 62 LS	A4	B5	0,8	L65
PAGODE	230 SL (113.042)	M 127.981	110/150	01.1963	01.1967	C 82 LS	A40	B6	0,7	L87
	250 SL (113.043)	M 129.982	110/150	01.1966	01.1968	C 82 LS	A40	B6	0,7	L87
	280 SL (113.044)	M 130.983	125/170	01.1968	03.1971	C 82 LS	A40	B6	0,7	L87
PONTON (W120)	180	M 136.925	48/65	07.1953	12.1962	C 32	A33		0,6	
PONTON (W121)	190 b	M 121.920	59/80	06.1959	12.1961	C 62 LS	A4	B5	0,8	L65
PONTON (W128)	220 SE	M 127.980	88/120	01.1958	08.1959	RC 72 LS	A32	B26	0,8	L87
PONTON (W180)	220 (180.010)	M 180.921	63/86	01.1954	12.1956	C 42 S	A12	B7	0,8	N43
	220 S (180.010)	M 180.924	78/106	01.1956	12.1959	C 42 S	A12	B7	0,8	N43
PULLMANN (W100)	600	M 100.980	184/250	09.1964	01.1979	RC 52 LS	A9	B20	0,8	L65
SL (R198)	300 SL (198.040)	M 198.980	158/215	05.1957	02.1963	C 82 LS	A40	B6	0,7	L87
SL (W121)	190 SL (121.042, 121.040)	M 121.921	77/105	01.1955	02.1963	RC 72 LS	A32	B26	0,8	L87
SL Coupé (C107)	280 SLC (107.022)	M 110.982 - M 110.986 (high compression)	130-136/177-185	06.1976	07.1985	C 62 LS	A4	B5	0,8	L65
	280 SLC (107.022)	M 110.982 - M 110.986 (low compression)	130-136/177-185	06.1976	07.1985	C 52 LS	A1	B1	0,8	L65
	350 SLC (107.023)	M 116.982 - M 116.984 (high compression)	143/195	03.1976	02.1980	C 62 LS	A4	B5	0,8	L65
	350 SLC (107.023)	M 116.982 - M 116.984 (low compression)	143/195	03.1976	02.1980	C 52 LS	A1	B1	0,8	L65
	350 SLC (107.023)	M 116.982 - M 116.984	147/200	01.1972	02.1976	C 62 LS	A4	B5	0,8	L65
	380 SLC (107.025)	M 116.960	160/218	07.1980	08.1981	C 62 LS	A4	B5	0,8	L65
	380 SLC (107.025)	M 116.960	160/218	07.1980	08.1981	C 52 LS	A1	B1	0,8	L65
	450 SLC (107.024)	M 117.982 - M117.985	160/218	09.1975	07.1979	RC 62 LS	A6	B17	0,8	L65
	450 SLC (107.024)	M 117.982	165/225	01.1973	11.1975	RC 72 LS	A32	B26	0,8	L87
	450 SLC (107.024)	M 117.985	165/225	01.1973	11.1975	RC 62 LS	A6	B17	0,8	L65
	450 SLC 5.0 (107.026)	M 117.960	177/241	06.1978	02.1980	RC 62 LS	A6	B17	0,8	L65
	450 SLC 5.0 (107.026)	M 117.960	177/241	06.1978	02.1980	C 52 LS	A1	B1	0,8	L65
SL Cabriolet (R107)	280 SL (107.042)	M 110.982 - M 110.986 - M 110.990	130-136/177-185	06.1976	07.1985	C 62 LS	A4	B5	0,8	L65
	300 SL (107.041)	M 103.982	132-138/180-188	09.1985	08.1989	C 52 LJS	A23		0,8	J65
	350 SL (107.043)	M 116.982 - M 116.984	143/195	03.1976	02.1980	C 62 LS	A4	B5	0,8	L65
	380 SL (107.045)	M 116.960 - M 116.962	150-160/204-218	07.1980	08.1985	C 62 LS	A4	B5	0,8	L65
	420 SL (107.047)	M 116.964	150-160/204-218	01.1986	08.1989	C 62 LS	A4	B5	0,8	L65
	450 SL (107.044)	M 117.982 - M117.985	160-165/218-224	09.1975	10.1980	RC 62 LS	A6	B17	0,8	L65
	500 SL (107.046)	M 117.964	164-180/223-245	01.1986	08.1989	C 62 LS	A4	B5	0,8	L65
	500 SL (107.046)	M 117.962	170-180/231-245	05.1980	12.1985	C 62 LS	A4	B5	0,8	L65
	500 SL (107.046)	M 117.960	117/241	05.1980	12.1981	C 62 LS	A4	B5	0,8	L65
	500 SL (107.046)	M 117.960 - M117.964	180/245	01.1986	08.1989	C 62 LS	A4	B5	0,8	L65
SL Cabriolet (R129)	280 (129.058)	M 104.943	142/193	08.1993	05.1997	FC 42 LS	A15	B14	0,8	F54
	280 (129.058)	M 104.943	142/193	06.1997	10.2001	RFC 58 LZ3EX	A58	B55	0,9	F54
	280 (129.059)	M 112.923	150/204	05.1998	08.2001	FN 42 LZDPR5	A195		1,05	
	300 SL (129.60)	M 103.984	140/190	03.1989	08.1993	C 52 LJS	A23		0,8	J65
	300 SL-24 (129.061)	M 104.981	170/231	03.1989	07.1993	FC 42 LS	A15	B14	0,8	F54
	320 SL (129.064)	M 112.943	165/224	06.1998	08.2001	FN 42 LZDPR5	A195		1,05	
	320 SL (129.063)	M 104.991	170/231	09.1993	06.1997	FC 42 LS	A15	B14	0,8	F54
	320 SL (129.063)	M 104.991	170/231	07.1997	05.1998	RFC 58 LZ3EX	A58	B55	0,9	F54
	500 (129.068)	M 113.961	225/306	05.1998	10.2001	FN 42 LZDPR5	A195		1,05	
	500 (129.067)	M 119.972	235/320	09.1992	08.1995	RFC 42 LS	A25		0,8	F54
	500 SL (129.066)	M 119.960	240/326	09.1989	08.1992	FC 52 LS	A2	B9	0,8	F54
	55 AMG (129.066)	M 113.985	260/354	03.2000	10.2001	FN 42 LZDPR5	A195		1,05	
	60 AMG (129.067)	M 122.981	280/381	05.1997	06.1998	FN 42 LZDPR5	A195		1,05	
	600 SL (129.073)	M 120.981	290/394	07.1992	06.1993	FC 42 LS	A15	B14	0,8	F54
SL Cabriolet (R230)	280 (230.454)	M 272.949	170/231	03.2008	01.2012	ZN 68 HSTDPR	A527		0,8	

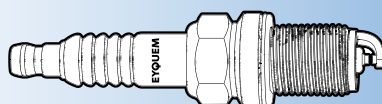

(1) Available until end of stock

- (a) 30 000 km
- (b) 60 000 km
- (c) Grey sticker on ignition coil
- (d) Green sticker on ignition coil

- (e) Hex 21 mm
- (f) Hex 16 mm
- (g) Recommended for cold weather



KW/HP



Box
10

Blister
4



F3-1

MERCEDES

	300 (230.454)	M 272.949	170/231	04.2009	01.2012	ZN 68 HSTDPR	A527		0,8	
	350 (230.456)	M 272.966	200/272	03.2006	01.2012	ZN 68 HSTDPR	A527		0,8	
	350 (230.458)	M 272.968	232/316	04.2008	01.2012	ZN 68 HSTDPR	A527		0,8	
	350 (230.467)	M 112.973	180/245	03.2003	01.2012	FN 42 LZDPR5	A195		1,05	
	500 (230.475)	M 113.963	225/306	10.2001	01.2012	FN 42 LZDPR5	A195		1,05	
	500 (230.488)	M 273.965	285/388	03.2006	01.2012	ZN 68 HSTDPR	A527		0,8	
	55 AMG (230.474)	M 113.992	350/476	10.2001	06.2002	RFN 62 HZDP	A504		0,8	
	55 AMG Kompressor (230.474)	M 113.992	368/500	06.2002	01.2012	RFN 62 HZDP	A504		0,8	
	55 AMG (230.472)	M 113.995	380/517	03.2006	01.2012	RFN 62 HZDP	A504		0,8	
SLK (R170)	200 (170.435)	M 111.946	100/136	08.1996	06.1997	FC 42 LS	A15	B14	0,8	F54
	200 (170.435)	M 111.946	100/136	07.1997	03.2000	RFC 58 LZ3EX	A58	B55	0,9	F54
	200 Kompressor (170.444)	M 111.958	120/163	03.2000	03.2004	RFN 58 LZDP5	A187		1,1	
	200 Kompressor (170.445)	M 111.943	141/192	10.1996	02.2000	RFC 58 LZ3EX	A58	B55	0,9	F54
	230 Kompressor (170.447)	M 111.973	142/193	08.1996	02.2000	RFC 58 LZ3EX	A58	B55	0,9	F54
	230 Kompressor (170.449)	M 111.983	145/197	03.2000	03.2004	RFN 58 LZDP5	A187		1,1	
	320 (170.465)	M 112.947	160/218	03.2000	03.2004	FN 42 LZDPR5	A195		1,05	
	32 AMG Kompressor (170.466)	M 112.960	260/354	03.2001	04.2004	RFN 58 LZDP5	A187		1,1	
SLK (R171)	200 Kompressor (171.442)	M 271.944	120/163	03.2004	11.2006	RFN 62 HZDP	A504		0,8	
		Engine n°-> 30853899								
	200 Kompressor (171.442)	M 271.944	120/163	12.2006	02.2011	ZN 68 HSTDPR	A527		0,8	
		Engine n° 30853900 ->								
	200 Kompressor (171.445)	M 271.954	135/184	01.2008	02.2011	ZN 68 HSTDPR	A527		0,8	
	280 (171.454)	M 272.942	170/231	01.2005	02.2011	ZN 68 HSTDPR	A527		0,8	
	300 (171.454)	M 272.942	170/231	04.2009	02.2011	ZN 68 HSTDPR	A527		0,8	
	350 (171.456)	M 272.963	200/272	06.2004	02.2011	ZN 68 HSTDPR	A527		0,8	
	350 (171.458)	M 272.969	224/305	01.2008	02.2011	ZN 68 HSTDPR	A527		0,8	
	55 AMG (171.473)	M 113.989	265/360	06.2004	11.2010	RFN 58 LZDP5	A187		1,1	
SLK (R172)	200 (172.448)	M 272.860 - M 272.861	135/184	02.2011		ZN 68 HSTDPR	A527		0,8	
	250 (172.447)	M 271.860 - M 271.861	150/204	02.2011		ZN 68 HSTDPR	A527		0,8	
SLR (R199)	5.4 (199.376)	M 155.980	460/626	04.2004		RFN 62 HZDP	A504		0,8	
	5.4 722 Edition	M 155.980	478/650	10.2006		RFN 62 HZDP	A504		0,8	
SLR ROADSTER (R199)	5.4	M 155.980	460/626	04.2007		RFN 62 HZDP	A504		0,8	
	5.4	M 155.980	478/650	10.2006		RFN 62 HZDP	A504		0,8	
SPRINTER 2t Bus (901, 902)	214 : 2.3 i	M 111.979	105/143	02.1995		FC 42 LS	A15	B14	0,8	F54
SPRINTER 2t camionnette (901, 902)	214	M 111.979	105/143	02.1995		FC 42 LS	A15	B14	0,8	F54
	214	M 111.984	105/143	02.1995	05.2006	RFC 42 LZ2E	A5	B30	1,0	F54
SPRINTER 2t camion/plate-forme (901, 902)	214 (902.011, 012, 611, 612)	M 111.979	105/143	02.1995		FC 42 LS	A15	B14	0,8	F54
	214 (902.011, 012, 611, 612)	M 111.984	105/143	02.1995	05.2006	RFC 42 LZ2E	A5	B30	1,0	F54
SPRINTER 3t Bus (903)	314 (903.071, 072, 073, 671,...)	M 111.979	105/143	02.1995		FC 42 LS	A15	B14	0,8	F54
	314 (903.071, 072, 073, 671,...)	M 111.984	105/143	02.1995	05.2006	RFC 42 LZ2E	A5	B30	1,0	F54
SPRINTER 3t Bus (906)	216 (906.713)	M 271.951	115/156	09.2008		ZN 68 HSTDPR	A527		0,8	
	324 (906.713)	M 272.979	190/258	06.2006	12.2013	ZN 68 HSTDPR	A527		0,8	
SPRINTER 3,5t Bus (906)	316 (906.733, 906.735)	M 271.951	115/156	09.2008		ZN 68 HSTDPR	A527		0,8	
	316 NGT (906.733, 906.735)	M 271.951	115/156	09.2008		ZN 68 HSTDPR	A527		0,8	
	316 LGT (906.733, 906.735)	M 271.951	115/156	09.2008		ZN 68 HSTDPR	A527		0,8	
	324 (906.733, 906.735)	M 272.979	190/258	06.2006	12.2013	ZN 68 HSTDPR	A527		0,8	
SPRINTER 3t camionnette (903)	314	M 111.979	105/143	02.1995		FC 42 LS	A15	B14	0,8	F54
	314	M 111.984	105/143	02.1995	05.2006	RFC 42 LZ2E	A5	B30	1,0	F54
SPRINTER 3t camionnette (906)	216 (906.613)	M 271.951	115/156	09.2008		ZN 68 HSTDPR	A527		0,8	
	224 (906.613)	M 272.979	190/258	06.2006		ZN 68 HSTDPR	A527		0,8	
SPRINTER 3,5t camionnette (906)	316 (906.633, 906.635)	M 271.951	115/156	09.2008		ZN 68 HSTDPR	A527		0,8	
	316 NGT (906.633, 906.635)	M 271.951	115/156	09.2008		ZN 68 HSTDPR	A527		0,8	
	316 LGT (906.633, 906.635)	M 271.951	115/156	09.2008		ZN 68 HSTDPR	A527		0,8	
	324 (906.633, 906.635, 637)	M 272.979	190/258	06.2006	12.2013	ZN 68 HSTDPR	A527		0,8	
SPRINTER 3t camion plate-forme (903)	314 (903.011, 012, 013, 022,...)	M 111.984	105/143	02.1995	05.2006	RFC 42 LZ2E	A5	B30	1,0	F54
SPRINTER 3t camion plate-forme (906)	216 (906.113, 906.213)	M 271.951	115/156	09.2008	05.2016	ZN 68 HSTDPR	A527		0,8	

(f) Available until end of stock

(a) 30 000 km

(b) 60 000 km

(c) Grey sticker on ignition coil

(d) Green sticker on ignition coil

(e) Hex 21 mm

(f) Hex 16 mm

(g) Recommended for cold weather

(g) Recommended for cold weather

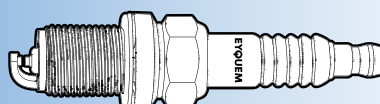

EYQUEM



Box
10

Blister
4



F3

MERCEDES

	224 (906.113, 906.213)	M 272.979	190/258	06.2006	12.2013	ZN 68 HSTDPR	A527		0,8	
SPRINTER 3,5t camion plate-forme (906)	316 (906.133, 135, 233, 235)	M 271.951	115/156	09.2008		ZN 68 HSTDPR	A527		0,8	
	316 NGT (906.133, 135, 233, 235)	M 271.951	115/156	09.2008		ZN 68 HSTDPR	A527		0,8	
	316 LGT (906.133, 135, 233, 235)	M 271.951	115/156	09.2008		ZN 68 HSTDPR	A527		0,8	
	324 (906.133, 135, 233, 235)	M 272.979	190/258	06.2006	12.2013	ZN 68 HSTDPR	A527		0,8	
SPRINTER 4t camionnette (904)	414 (904.062, 063, 662, 663)	M 111.979	105/143	02.1995		FC 42 LS	A15	B14	0,8	F54
	414	M 111.984	105/143	02.1996		RFC 42 LZ2E	A5	B30	1,0	F54
SPRINTER 4t camion/ plate-forme (904)	414 (904.012, 013, 612, 613)	M 111.979	105/143	02.1996		FC 42 LS	A15	B14	0,8	F54
	414 (904.012, 013, 612, 613)	M 111.984	105/143	02.1996		RFC 42 LZ2E	A5	B30	1,0	F54
SPRINTER 4,6t camionnette (906)	424(906.653, 655, 657)	M 272.979	190/258	06.2006	12.2013	ZN 68 HSTDPR	A527		0,8	
SPRINTER 4,6t camion plate-forme (906)	426 (906.153, 155, 253, 255)	M 272.979	190/258	06.2006	12.2013	ZN 68 HSTDPR	A527		0,8	
SPRINTER 5t camionnette (906)	524(906.653, 906.655, 906.657)	M 272.979	190/258	06.2006	12.2013	ZN 68 HSTDPR	A527		0,8	
SPRINTER 5t camion plate-forme (906)	516 (906.153, 906.155, 906.253, 255)	M 271.951	115/156	09.2008		ZN 68 HSTDPR	A527		0,8	
	516 NGT (906.153, 906.155, 905.253, 255)	M 271.951	115/156	09.2008		ZN 68 HSTDPR	A527		0,8	
	524 (906.153, 906.155, 906.253, 255)	M 272.979	190/258	06.2006	12.2013	ZN 68 HSTDPR	A527		0,8	
T1 Autobus (601) 2t	208 : 2.3	M 115.955 - M 115.972	62-63/84-86	05.1977	12.1982	C 62 LS	A4	B5	0,8	L65
	210 : 2.3	M 102.942 - M 102.945	70-77/95-115	07.1982	06.1995	C 52 LJS	A23		0,8	J65
T1 Camionnette (601, 611) 2t	210 : 2.3	M 102.942 - M 102.945	70-77/95-115	08.1982	06.1995	C 52 LJS	A23		0,8	J65
T1 Camion/ plateforme (601) 2t	210 : 2.3	M 102.942	70/95	04.1977	10.1989	C 52 LJS	A23		0,8	J65
	210 : 2.3	M 115.955 - M 115.972	62-63/84-86	04.1977	10.1989	C 62 LS	A4	B5	0,8	L65
T1 Utilitaire 3t	308 : 2.3	M 115.955 - M 115.972	62-63/84-86	05.1977	08.1982	C 62 LS	A4	B5	0,8	L65
	308 : 2.3	M 102.942 - M 102.945	70/95			C 52 LJS	A23		0,8	J65
	309 : 2.3	M 102...		08.1992		C 52 LJS	A23		0,8	J65
	310 : 2.3	M 115.972	63/86	05.1977	08.1982	C 62 LS	A4	B5	0,8	L65
	310 : 2.3	M 102.942 - M 102.945	70-77/95-115	08.1982	06.1995	C 52 LJS	A23		0,8	J65
T1 Camion/ plate-forme 4t	410 (611.017, 611.018)	M 102.942	70/95	08.1982	06.1995	C 52 LJS	A23		0,8	J65
	410 (611.017, 611.018)	M 102.942	77/105	08.1982	06.1995	C 52 LJS	A23		0,8	J65
T1 Camionnette 4t	410 (611.067, 611.068)	M 102.902 - M 102.942 - M 102.945	70-77/95-105	08.1982	12.1994	C 52 LJS	A23		0,8	J65
T2/LN1 Camionnette/ break	510 (667.061, 667.062)	M 102.946	70-77/95-105	04.1986	12.1994	C 52 LJS	A23		0,8	J65
T2/LN1 Camion/ plate-forme	510 (667.001, 667.002)	M 102.946	70-77/95-105	04.1986	12.1994	C 52 LJS	A23		0,8	J65
T2/LN1 Camion plate-forme	L 408 G (309.000, 001,002, 003, 011)	M 115.921	55/75	08.1972	12.1974	C 82 LS	A40	B6	0,8	L87
	L 408 G (309.000, 001,002, 003, 011)	M 115.928	55/75	08.1972	12.1974	C 62 LS	A4	B5	0,8	L65
	L 408 G (309.000, 001,002, 003, 011)	M 115.921	63/85	08.1972	12.1974	C 82 LS	A40	B6	0,8	L87
	L 408 G (309.000, 001,002, 003, 011)	M 115.928	63/85	08.1972	12.1974	C 62 LS	A4	B5	0,8	L65
	L 409 (309.000, 001,002, 003)	M 115.952	66/90	01.1975	08.1982	C 62 LS	A4	B5	0,8	L65
	L 410 (309.000, 309.002)	M 102.943	70/95	08.1982	12.1988	C 52 LJS	A23		0,8	J65
T2/L Camion basculant	LK 408 G (309.040, 309.041)	M 115.921	63/85	01.1968	12.1974	C 82 LS	A40	B6	0,8	L87
	LK 408 G, LK 409 (309.040, 041, 044)	M 115.952	66/90	01.1975	08.1982	C 62 LS	A4	B5	0,8	L65
	LK 408 G, LK 409 (309.041, 309.044)	M 102.943	70/95	08.1982	09.1983	C 52 LJS	A23		0,8	J65
T2/L Camionnette/ break	L 408 G (309.012, 013, 014, 015,...)	M 115.11	55/75	01.1968	12.1972	C 62 LS	A4	B5	0,8	L65
	L 408 G (309.012, 013, 014, 015,...)	M 115.1	63/85	01.1968	12.1972	C 62 LS	A4	B5	0,8	L65
	L 408 G (309.012, 013, 014, 015,...)	M 115.921	55-63/75-85	08.1972	12.1974	C 82 LS	A40	B6	0,8	L87
	L 408 G (309.012, 013, 014, 015,...)	M 115.928	55-63/75-85	08.1972	12.1974	C 62 LS	A4	B5	0,8	L65
	L 409 (309.012, 013, 014, 015,...)	M 115.952	66/90	01.1975	08.1982	C 62 LS	A4	B5	0,8	L65
	L 410 (309.012, 013, 014, 015,...)	M 102.943	70/95	08.1982	12.1988	C 52 LJS	A23		0,8	J65
VANEO (414)	1.6 i (414.700)	M 166.961 Cat	60/82	02.2002	07.2005	RFC 58 LZ3EX	A58	B55	0,9	F54
	1.6 i (414.700)	M 166.961 Cat	75/102	02.2002	07.2005	RFC 58 LZ3EX	A58	B55	0,9	F54
	1.9 i (414.700)	M 166.991	92/125	02.2002	07.2005	RFC 58 LZ3EX	A58	B55	0,9	F54

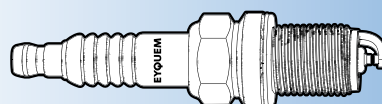

- (1) Available until end of stock
 (a) 30 000 km
 (b) 60 000 km
 (c) Grey sticker on ignition coil
 (d) Green sticker on ignition coil

- (e) Hex 21 mm
 (f) Hex 16 mm
 (g) Recommended for cold weather



Box
10

Blister
4



F3-1

MERCEDES

VIANO (W639)	3.2	M 112.951	140/190	09.2003		FN 42 LZDPR5	A195		1,05	
	3.2	M 112.951	160/218	09.2003		FN 42 LZDPR5	A195		1,05	
	3.5	M 272.979	190/258	09.2007		ZN 68 HSTDPR	A527		0,8	
	3.7	M 112.976	170/231	06.2004		FN 42 LZDPR5	A195		1,05	
VITO Bus (638)	113 2.0 (638.114, 638.194)	M 111.948	95-100/129-136	11.1995	07.2003	RFC 42 LZ2E	A5	B30	1,0	F54
	114 2.3 (638.134, 638.194)	M 111.978	105/143	11.1995	07.2003	RFC 42 LZ2E	A5	B30	1,0	F54
VITO camionnette (638)	113 2.0 (638.014, 638.094)	M 111.948	95/129	03.1997	07.2003	RFC 42 LZ2E	A5	B30	1,0	F54
	114 2.3 (638.034, 638.094)	M 111.978	105/143	03.1997	07.2003	RFC 42 LZ2E	A5	B30	1,0	F54
VITO / MIXTO camionnette (W639)	119	M 112.951	140/190	09.2003		FN 42 LZDPR5	A195		1,05	
	122	M 112.951	160/218	09.2003		FN 42 LZDPR5	A195		1,05	
	123 (639.603)	M 112.976	170/231	06.2004	07.2008	FN 42 LZDPR5	A195		1,05	
	126	M 272.978	190/258	09.2007		ZN 68 HSTDPR	A527		0,8	
VITO Bus (W639)	119	M 112.951	140/190	09.2003		FN 42 LZDPR5	A195		1,05	
	122	M 112.951	160/218	09.2003		FN 42 LZDPR5	A195		1,05	
	123	M 112.976	170/231	06.2004		FN 42 LZDPR5	A195		1,05	
	126	M 272.978	190/258	09.2007		ZN 68 HSTDPR	A527		0,8	

MERCURY

CAPRI	1.6 i Turbo			09.1990		RFC 42 LS	A25		0,8	F54
LYNX	1.6 i Turbo	(8)				RC 52 LJS	A62	B27	0,7	J65

MG

TF	115	16 K4F	85/115	03.2002		RFN 58 LZDP5	A187		1,1	
	120	18 K4F	88/120	03.2002		RFN 58 LZDP5	A187		1,1	
	135	18 K4F	100/136	03.2002		RFN 58 LZDP5	A187		1,1	
	160	18 K4K	118/160	03.2002		RFN 58 LZDP5	A187		1,1	
ZR	105	14 K4F	76/103	06.2001		RFN 58 LZDP5	A187		1,1	
	105	14 K4F	76/103	06.2001		RFC 52 LS5	A26	B24	0,9	F54-5
	120	18 K4F	86/117	06.2001		RFN 58 LZDP5	A187		1,1	
	160	18 K4K	118/160	06.2001		RFN 58 LZDP5	A187		1,1	
	120	18 K4F	86/117	07.2001		RFN 58 LZDP5	A187		1,1	
	180	25 K4F	130/177	07.2001		RFN 58 LZDP5	A187		1,1	
ZS Hatchback	120	18 K4F	86/117	07.2001		RFN 58 LZDP5	A187		1,1	
	180	25 K4F	130/177	07.2001		RFN 58 LZDP5	A187		1,1	
ZT	1.8 16V	18 K4F	88/120	01.2003		RFN 58 LZDP5	A187		1,1	
	1.8 T 16V		118/160	01.2003		RFN 58 LZDP5	A187		1,1	
	160	25 K4F	118/160	06.2001		RFN 58 LZDP5	A187		1,1	
	180	25 K4F	130/177	01.2003		RFN 58 LZDP5	A187		1,1	
	190	25 K4F	140/190	06.2001		RFN 58 LZDP5	A187		1,1	
ZT- T	1.8 16V	18 K4F	88/120	01.2003		RFN 58 LZDP5	A187		1,1	
	1.8 T 16V		118/160	01.2003		RFN 58 LZDP5	A187		1,1	
	160	25 K4F	118/160	10.2001		RFN 58 LZDP5	A187		1,1	
	190	25 K4F	140/190	10.2001		RFN 58 LZDP5	A187		1,1	
MGF	1,8 i VVC	18 K4K	118/160	10.2001	03.2002	RFN 58 LZDP5	A187		1,1	
	1.6	16 K4F	82/112	02.2000	03.2002	RFN 58 LZDP5	A187		1,1	
	1.8 i 16V	18 K4F	88/120	03.1995	03.2002	RFN 58 LZDP5	A187		1,1	
	1.8 i VVC	18 K4K	107/145	03.1995	03.2002	RFN 58 LZDP5	A187		1,1	
MGR V8	3.9		140/190	09.1992	12.1995	RC 62 LS	A6	B17	0,8	L65

MG-ROVER

MAESTRO	1.6	R Series TC				RC 72 LS	A32	B26	0,8	L87
	1.6	S Series TC				RFC 58 LS	A18		0,8	F54
	2.0 i	O Series				RC 72 LS	A32	B26	0,8	L87
	2.0 Turbo T	O Series Turbo				RC 72 LS	A32	B26	0,8	L87
METRO	1.3	A Series				RC 62 LS	A6	B17	0,8	L65
	1.3 Turbo T	A Series				RC 72 LS	A32	B26	0,8	L87
MGB	1.8 GT, Sport	B Series TC		01.1961	12.1981	RC 62 LS	A6	B17	0,8	L65
	3.5 V8 GT			01.1974	12.1976	C 32 S	A8	B3	0,8	N43
MIDGET	1.3 i MK II	A Series TC				RC 62 LS	A6	B17	0,8	L65
	1500 : 1.5	Triumph TC				RC 32 LS	A49	B19	0,8	L3
MONTEGO	2.0 i	O Series				RC 72 LS	A32	B26	0,8	L87
	2.0 Turbo	O Series Turbo				RC 72 LS	A32	B26	0,8	L87

(1) Available until end of stock

(a) 30 000 km

(b) 60 000 km

(c) Grey sticker on ignition coil

(d) Green sticker on ignition coil

(e) Hex 21 mm

(f) Hex 16 mm

(g) Recommended for cold weather



EYQUEM



Box 10
Blister 4



F3 → 1

MINI									
MINI (F55)	NEW	Cooper	B38 A15 A	100/136	12.2013		RXN 72HSIPFSO	A550	0,75
	NEW	Cooper S	B48 A20 A / B46 A20 A	141/192	12.2013		RXN 72HSIPFSO	A550	0,75
	NEW	One	B38 A12 A	75/102	03.2014		RXN 72HSIPFSO	A550	0,75
	NEW	One First	B38 A12 A	55/75	10.2015		RXN 72HSIPFSO	A550	0,75
MINI (F56)	NEW	Cooper	B38 A15 A	100/136	12.2013		RXN 72HSIPFSO	A550	0,75
	NEW	Cooper	B36 A15 A	100/136	04.2013	10.2015	RXN 72HSIPFSO	A550	0,75
	NEW	Cooper S	B48 A20 A	141/192	04.2013	10.2015	RXN 72HSIPFSO	A550	0,75
	NEW	Cooper S	B46 A20 A	141/192	12.2013		RXN 72HSIPFSO	A550	0,75
	NEW	John Cooper Works	B48 A20 B	170/231	03.2015		RXN 72HSIPFSO	A550	0,75
	NEW	One	B38 A12 A	75/102	03.2014	11.2017	RXN 72HSIPFSO	A550	0,75
MINI (R50-R53)	NEW	One First	B38 A12 A	55/75	11.2013	10.2015	RXN 72HSIPFSO	A550	0,75
		One	W10B16A	66/90	06.2001	09.2006	RFC 58 LZP4	A193	1,5
		One	W10B16A	85/115	06.2001	09.2006	RFC 58 LZP4	A193	1,5
		Cooper S	W11B16A	120/163	03.2002	09.2006	RFC 58 LZP4	A193	1,5
		Cooper S	W11B16A	125/170	07.2004	09.2006	RFC 58 LZP4	A193	1,5
		Cooper Works	W11B16A	155/211	11.2003	09.2006	RFC 58 LZP4	A193	1,5
MINI (R56)		Cooper	N12B16A	88/120	10.2006		RXN 62 HSEP	A514	1.0
		One	N12B14A	70/95	03.2007	09.2009	RXC 62 HSEDP	A189	0,9
		One	N12B14A	70/95	10.2009		RXN 62 HSEP	A514	1.0
		One	N12B14A	55/75	03.2009		RXC 62 HSEDP	A189	0,9
		One	N12B14A	55/75	03.2010		RXN 62 HSEP	A514	1.0
		One	N16B16A	72/98	03.2010		RXN 62 HSEP	A514	1.0
		Cooper	N16B16A	85/115	03.2010		RXN 62 HSEP	A514	1.0
		Cooper	N12B16A	88/120	10.2006	09.2009	RXC 62 HSEDP	A189	0,9
		Cooper	N12B16A	88/120	10.2009		RXN 62 HSEP	A514	1.0
		Cooper	N16B16A	90/122	03.2010		RXN 62 HSEP	A514	1.0
		CooperS	N18B16A	120/163	03.2010		RXN 62 HSDP	A525	0,7
		CooperS	N18B16A	135/184	11.2011		RXN 62 HSDP	A525	0,7
		CooperS	N18B16A	147/200	01.2012		RXN 62 HSDP	A525	0,7
	MINI Cabriolet (F57)	NEW	Cooper	B38 A15 A	100/136	11.2015		RXN 72HSIPFSO	A550
NEW		Cooper S	B48 A20 A	141/192	03.2015		RXN 72HSIPFSO	A550	0,75
NEW		John Cooper Works	B48 A20 B	170/231	03.2016		RXN 72HSIPFSO	A550	0,75
NEW		One	B38 A12 A	75/102	03.2016	10.2017	RXN 72HSIPFSO	A550	0,75
MINI Cabriolet (R57)		Cooper	N12B16A	88/120	03.2009	09.2009	RXC 62 HSEDP	A189	1.0
		Cooper	N12B16A	88/120	10.2009		RXN 62 HSEP	A514	1.0
		Cooper	N16B16A	90/122	03.2010		RXN 62 HSEP	A514	1.0
		One	N16B16A	72/98	03.2010		RXN 62 HSEP	A514	1.0
		CooperS	N14B16A	128/174	11.2011		RXN 62 HSDP	A525	0,7
		CooperS	N18B16A	135/184	11.2011		RXN 62 HSDP	A525	0,7
		CooperS	N18B16A	147/200	03.2010		RXN 62 HSDP	A525	0,7
MINI CLUBMAN (F54)	NEW	Cooper	B38 A15 A / B36 A15 A	100/136	07.2015		RXN 72HSIPFSO	A550	0,75
	NEW	Cooper S	B48 A20 A / B46 A20 A	141/192	07.2015		RXN 72HSIPFSO	A550	0,75
	NEW	Cooper S ALL4	B48 A20 A	141/192	01.2016		RXN 72HSIPFSO	A550	0,75
	NEW	John Cooper Works	B48 A20 B	170/231	11.2015		RXN 72HSIPFSO	A550	0,75
MINI CLUBMAN (R55)	NEW	One	B38 A15 A	75/102	11.2015		RXN 72HSIPFSO	A550	0,75
		Cooper	N12B16A	88/120	10.2007		RXN 62 HSEP	A514	1.0
		Cooper		90/122	03.2010		RXN 62 HSEP	A514	1.0
		One		72/98	03.2010		RXN 62 HSEP	A514	1.0
		One	N12B14A	70/95	03.2009	02.2010	RXN 62 HSEP	A514	1.0
MINI COUNTRYMAN (F60)	NEW	Cooper	B38 A15 A / B36 A15 A	100/136	10.2016		RXN 72HSIPFSO	A550	0,75
	NEW	Cooper ALL4	B38 A15 A	100/136	10.2016		RXN 72HSIPFSO	A550	0,75
	NEW	Cooper S	B48 A20 A / B46 A20 A	141/192	10.2016		RXN 72HSIPFSO	A550	0,75
	NEW	Cooper S ALL4	B48 A20 A / B46 A20 A	141/192	10.2016		RXN 72HSIPFSO	A550	0,75
	NEW	Cooper SE ALL4	B38 A15 A	165/224	01.2017		RXN 72HSIPFSO	A550	0,75
	NEW	John Cooper Works ALL4	B48 A20 B	170/231	01.2017		RXN 72HSIPFSO	A550	0,75
MINI COUNTRYMAN (R60)		One	N16B16A	72/98	06.2010		RXN 62 HSEP	A514	1.0
		Cooper	N16B16A	90/122	06.2010		RXN 62 HSEP	A514	1.0
		CooperS - CooperS ALL4	N18B16A	135/184	06.2010		RXN 62 HSDP	A525	0,7
MINI Coupe (R58)		Cooper	N16B16A	90/122	09.2011		RXN 62 HSEP	A514	1.0
		CooperS	N18B16A	135/184	09.2011		RXN 62 HSDP	A525	0,7
		CooperS	N18B16A	147/200	09.2011		RXN 62 HSDP	A525	0,7

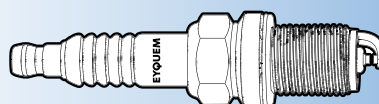

- (1) Available until end of stock
- (a) 30 000 km
- (b) 60 000 km
- (c) Grey sticker on ignition coil
- (d) Green sticker on ignition coil

- (e) Hex 21 mm
- (f) Hex 16 mm
- (g) Recommended for cold weather



Box
10 Blister
4



F3→1

MINI

MINI Roadster (R59)	Cooper	N16B16A	90/122	02.2012	RXN 62 HSEP	A514	1.0	
	CooperS	N18B16A	135/184	02.2012	RXN 62 HSDP	A525	0.7	
	CooperS	N18B16A	147/200	02.2012	RXN 62 HSDP	A525	0.7	

MITSUBISHI

3000 GT	3.0 24V 4x4	6 G 72	210/286	06.1992	RFN 58 LZDP5	A187	1,1	
A81P, A81V, A82V, A82O					RC 62 LS	A6	B17	0,8 L65
AIR TREK	2.0 i 16V	4G63 [DOHC] Cat	106/144	06.2001	RC 72 LS	A32	B26	0,8 L87
CANTER	2.0 i 16V	4G63 [SOHC] Cat	74/101	09.1996	RC 62 LS	A6	B17	0,8 L65
	2.4	4G53		12.1980	C 52 LS	A1	B1	0,8 L65
	2.4 FC-35B	4G53			C 62 LS	A4	B5	0,8 L65
	2.6 FC-35B	4G54	73-76/99-103	01.1980	RC 62 LS	A6	B17	0,8 L65
	55 : 2.6	4G54	76/103	01.1982	RC 62 LS	A6	B17	0,8 L65
CARISMA	1.6 i 16V	4G92 [SOHC] Cat	66/90	05.1995	RFC 58 LS5	A38	B48	1,1 F54-5
	1.8 16V GDI	4G93	92/125	09.1997	02.1989	RFC 42 LS5	A83	0,9 F54-5
	1.8 GDI		90/122	10.2000		RFC 42 LS5	A83	0,9 F54-5
	1.8 i	4G93 [SOHC] Cat	85/115	05.1995		RFC 58 LS5	A38	B48 1,1 F54-5
	1.8 i 16V	4G93 [DOHC] Cat	103/140	05.1995		RFC 52 LS5	A26	B24 1,1 F54-5
	1.8 i 16V Elegance	4G93 GDI	92/125	09.1997		RFC 52 LS5	A26	B24 1,1 F54-5
CELESTE	1.4			12.1981	RC 52 LS	A9	B20	0,8 L65
	1.6 GSR, ST	4G32 1 carburator			RC 52 LS	A9	B20	0,8 L65
	1.6 GSR, ST	4G32 2 carburator			RC 62 LS	A6	B17	1,0 L65
	2.0	4G52		05.1980	C 62 LS	A4	B5	0,8 L65
CHALLENGER	2.4 i 16V	4G64 [SOHC] Cat	97/132	07.1996	RFC 52 LS5	A26	B24	1,1 F54-5
	3.0 i 24V	6G 72 [DOHC]	151/205	07.1996	08.1998	RFC 52 LS5	A26	B24 1,1 F54-5
CHARIOT GRANDIS	1.8 i	G37B	62/84	06.1984	05.1991	RC 62 LS5	A24	1,1 L65-5
	2.0	G63B	75/102	06.1984	05.1991	RC 62 LS5	A24	1,1 L65-5
	2.0 i	4G63 [SOHC] Cat	80/109	05.1991	10.1997	RC 62 LS5	A24	1,1 L65-5
	2.0 i 16V	4G63 [DOHC] Cat	106/144	05.1991	10.1997	RC 72 LS	A32	B26 0,8 L87
	2.4 i 16V	4G64 [SOHC] Cat	97/132	05.1993	10.1997	RFC 52 LS5	A26	B24 1,1 F54-5
COLT	1.1	3A91	55/75	10.2004		RFC 58 HZEDP5	A191	1,1
	1.2	4G11	40/54	07.1980	04.1984	RC 52 LS	A9	B20 0,8 L65
	1.2	4G16	40-44/54-60	11.1983	04.1989	RC 62 LS	A6	B17 0,8 L65
	1.2 GL	G11B	41/56	09.1979	06.1980	C 52 LS	A1	B1 0,8 L65
	1.3	G13B Cat	49/67	06.1986	04.1988	RC 62 LS5	A24	1,1 L65-5
	1.3	4G13	49-55/67-75	04.1988	08.1990	RC 52 LS5	A36	B38 1,1 L65-5
	1.3		51/69	04.1988	05.1992	RC 62 LS	A6	B17 0,8 L65
	1.3	4A90	70/95	06.2004		RFC 58 HZEDP5	A191	1,1
	1.3 12V	4 G 13 (BJ90-92, 12V)	55/75	04.1988	08.1990	RC 62 LS	A6	B17 0,8 L65
	1.3 GL	4 G 13	44/60	04.1988	12.1990	RC 62 LS	A6	B17 0,8 L65
	1.3 i 12V	4G13 [SOHC] Cat	55/75	12.1991		RC 52 LS5	A36	B38 1,1 L65-5
	1.4	4G12	52/71	07.1980	10.1983	C 52 LS	A1	B1 0,8 L65
	1.4 GLX, GT	G33B		09.1979	06.1980	C 52 LS	A1	B1 0,8 L65
	1.4 Turbo	4G12 T	77/105	06.1980	12.1983	RC 72 LS	A32	B26 0,8 L87
	1.5	4G15	55/75	11.1983	04.1989	RC 62 LS	A6	B17 0,8 L65
	1.5	G15B Cat	51/69	01.1984	04.1988	RC 62 LS5	A24	1,1 L65-5
	1.5	G31B	61/83	01.1984	04.1989	RC 62 LS	A6	B17 0,8 L65
	1.5	4A91	80/109	06.2004		RFC 58 HZEDP5	A191	1,1
	1.5 i	4G15	55/75	04.1988	05.1992	RC 62 LS5	A24	1,1 L65-5
	1.5 i	4G15 Cat	62-66/84-90	04.1988	05.1992	RC 62 LS5	A24	1,1 L65-5
	1.5 i 16V	4G15 [DOHC] Cat	81/110	03.1996		RC 62 LS5	A24	1,1 L65-5
	1.6 i 16V	4G61 [DOHC] Cat	91-100-118/ 124-136-160	04.1988	05.1990	RC 62 LS	A6	B17 0,8 L65
	1.6 i 16V	4G92 [SOHC] Cat	66/90	07.1995		RFC 58 LS5	A38	B48 1,1 F54-5
	1.6 i 16V 4x4	4G92 [DOHC] Cat	83/113	12.1991	05.1996	RFC 52 LS5	A26	B24 1,1 F54-5
	1.6 i Turbo	4G32 T/C	92/125	09.1983	06.1988	RC 72 LS	A32	B26 0,8 L87
	1.6 i Turbo	G32B T Cat	77/105	07.1986	04.1988	RC 82 LS	A78	0,8 L87
	1.6 Turbo Eci	4 G 32 T/C	92/125	02.1984	04.1988	C 62 LS	A4	B5 0,8 L65
	1.8 GTi 16V KAT	4G67	100/136	06.1990	05.1992	RC 72 LS	A32	B26 0,8 L87
	1.8 i 16V	4G67 [DOHC] Cat	100/136	09.1989	05.1992	RC 62 LS5	A24	1,1 L65-5
	1.8 i 16V	4G93 [DOHC] Cat	103/140	12.1991	05.1996	RFC 52 LS5	A26	B24 1,1 F54-5
	1.8 i 16V Turbo	4G93 T [DOHC] Cat	151/205	03.1996	06.2010	RFC 58 LS	A18	0,8 F54
COLT VI (Z3A-Z2A)	NEW 1.1	3A91	55/75	10.2004	06.2010	RFN 58 HZ5	A534	1.15
	NEW 1.3	4A90	70/95	06.2004	06.2010	RFN 58 HZ5	A534	1.15

(1) Available until end of stock

(a) 30 000 km

(b) 60 000 km

(c) Grey sticker on ignition coil

(d) Green sticker on ignition coil

(e) Hex 21 mm

(f) Hex 16 mm

(g) Recommended for cold weather



EYQUEM



Box
10

Blister
4



F3-1

MITSUBISHI

Model	Engine	Power (kW/HP)	Year 1	Year 2	Box	Blister	Other			
NEW	1.3 LPG	4A90	70/95	06.2004	06.2010	RFC 58 HZEDP5	A191	1,1		
	1.5	4A91	80/109	06.2004	06.2010	RFC 58 HZEDP5	A191	1,1		
COLT CZC Cabrio (RG)	1.5	4A91	80/109	05.2006	07.2008	RFC 58 HZEDP5	A191	1,1		
CORDIA	1.6 Turbo	4G32 T	55-84/75-114	09.1982	08.1988	RC 62 LS	A6	B17	0,8	L65
	1.8	4G37	66/90	09.1986	08.1988	C 62 LS	A4	B5	1,0	L65
	1.8 i Turbo	4G62 T	100/136	09.1984	08.1988	RC 72 L	A114		0,8	
	1.8 i Turbo	G62B	100/136	10.1986		RC 72 LS5	A116		1,0	L87
DEBONAIR	2.6	4G54	89/121	01.1977	12.1986	RC 62 LS	A6	B17	0,8	L65
DEBONAIR V	2.0 i V6	6G 71	92/125	07.1986	09.1992	RC 52 LS5	A36	B38	1,1	L65-5
	3.0 i 24V	6G 72 [DOHC]	151/205	10.1989	09.1992	RFC 52 LS5	A26	B24	1,1	F54-5
	3.0 i V6	6G 72 [SOHC]	111/151	09.1988		C 52 LS	A1	B1	1,1	L65
	3.0 i V6	6G 72 [SOHC]	111/151	09.1988		RC 52 LS5	A36	B38	1,1	L65-5
DELICA	1.4	G33B	10.1982	05.1994		C 52 LS	A1	B1	0,8	L65
	1.6	G32B	48/65	10.1980	05.1994	RC 62 LS5	A24		1,1	L65-5
	1.6 i 16V	4G92 [DOHC] Cat	83/113	05.1994		RFC 52 LS5	A26	B24	1,1	F54-5
	2.0	G63B	75/102	12.1983		RC 62 LS5	A24		1,1	L65-5
	2.0	FEE		09.1999		RFC 52 LS5	A26	B24	1,1	F54-5
	2.0 i	4G63 [SOHC] Cat	80/109	05.1994		RC 62 LS5	A24		1,1	L65-5
	2.4 i	4G64 [SOHC] Cat	82/112	08.1989	05.1994	RC 62 LS5	A24		1,1	L65-5
	2.4 i 16V	4G64 [SOHC] Cat	97/132	05.1994		RFC 52 LS5	A26	B24	1,1	F54-5
	3.0 i 24V	6G 72 [DOHC]	151/205	05.1994		RFC 52 LS5	A26	B24	1,1	F54-5
DIAMANTE	2.0 i V6	6G 71	92/125	05.1990	09.1992	RC 52 LS5	A36	B38	1,1	L65-5
	3.0 i 24V	6G 72 [DOHC]	151/205	01.1990		RFC 52 LS5	A26	B24	1,1	F54-5
	3.0 i V6	6G 72 [SOHC]	104/141	01.1990		RC 52 LS5	A36	B38	1,1	L65-5
ECLIPSE	2.0 i 16V	4G63 [SOHC] Cat	100/136	02.1990	06.1995	RC 62 LS	A6	B17	0,8	L65
	2.0 i 16V	4G63 [DOHC] Cat	106/144	02.1990	06.1995	RC 72 LS	A32	B26	0,8	L87
	2.0 i 16V 4x4	4G63 [DOHC] Cat	104-107/141-146	04.1991	10.1995	RC 62 LS5	A24		1,1	L65-5
	2.0 i 16V 4x4	4G63 [DOHC] Cat	110/150	04.1991	10.1995	RC 72 LS	A32	B26	0,8	L87
	2400 GS 16V		105/143	09.1998		RFC 42 LS5	A83		0,9	F54-5
EMERAUDE	1.8 i 16V	4G93 [SOHC] Cat	92/125	11.1992	08.1996	RFC 52 LS5	A26	B24	1,1	F54-5
	1.8 i 16V	4G93 [DOHC] Cat	103/140	10.1994	08.1996	RFC 52 LS5	A26	B24	1,1	F54-5
EXPO	1.8 i	4G93 [SOHC] Cat	85/115	01.1994		RFC 52 LS5	A26	B24	1,1	F54-5
	2.4 i	4G64 [SOHC] Cat	82/112	01.1994		RFC 52 LS5	A26	B24	1,1	F54-5
FORTE	1.6	G32B	48/65	12.1982		RC 62 LS5	A24		1,1	L65-5
	2.0	G63B	75/102	12.1982		RC 62 LS5	A24		1,1	L65-5
FTO	1.8 i 16V	4G93 [SOHC] Cat	92/125	10.1994		RFC 52 LS5	A26	B24	1,1	F54-5
GALANT	1.6	4G32	55/75	06.1984	10.1987	RC 62 LS	A6	B17	1,0	L65
	1.6 MCA	4G32		01.1974	04.1980	C 62 LS	A4	B5	1,0	L65
	1.7 GS	4G35		01.1973	04.1980	C 52 LS	A1	B1	0,8	L65
	1.8 5 SL	4G51		05.1976	04.1980	C 62 LS	A4	B5	1,0	L65
	2.0	4G63 [SOHC]	75/102	05.1980	05.1984	RC 62 LS	A6	B17	1,0	L65
	2.0	4G63 [SOHC]	75-81/102-110	05.1980	05.1984	RC 82 LS	A78		0,8	L87
	2.0	G63B Cat	66/90	06.1986	11.1987	RC 62 LS5	A24		1,1	L65-5
	2.0 (EA)		100/136	09.1996	09.2000	RFN 58 LZDP5	A187		1,1	
	2.0 GL, GLS, GLX	4G52		01.1973	04.1980	RC 62 LS5	A24		1,1	L65-5
	2.0 GLSI	4G63	101/137	11.1992	08.1996	RFC 52 LS5	A26	B24	0,9	F54-5
	2.0 GLSI 4x4	4G63	101/137	11.1992	08.1996	RFC 52 LS5	A26	B24	0,9	F54-5
	2.0 GTI 16V, 4x4 (E3_A)	4G63	110/150	09.1991	10.1992	RFN 58 LZDP5	A187		1,1	
	2.0 i Turbo	4G63 T	107-110/146-150	06.1984	11.1987	RC 72 L	A114		0,8	
2.0 Station Wagon	4G63	98/133	09.2000	09.2002	RFC 52 LS5	A26	B24	0,9	F54-5	
2.0 V6-24 (E5_A, E7_A, E8_A)	6A12 MPI 24V	110/150	11.1992	08.1996	RFN 58 LZDP5	A187		1,1		
2.4 i	G64B Cat	82/112	07.1985	02.1988	RC 62 LS5	A24		1,1	L65-5	
2.5 V6 24V (EA)	6A13	118-120	09.1996		RFN 58 LZDP5	A187		1,1		
2.5 V6-24 4x4 (E5_A, E7_A, E8_A)	6G73	125/170	11.1992	08.1996	RFN 58 LZDP5	A187		1,1		
GALANT - ASPIRE - ETERNA - CAVA	1.6	4G32	55/75	10.1987	10.1992	RC 62 LS5	A24		1,1	L65-5
	1.8 Hatchback	4G37	66/90	11.1987	10.1992	RC 62 LS5	A24		1,1	L65-5
	1.8 i	4G37 Cat	66/90	10.1989	10.1992	RC 62 LS5	A24		1,1	L65-5
	1.8 i	4G93 [SOHC] Cat	85-93/115-126	11.1992	05.1996	RFC 58 LS5	A38	B48	1,1	F54-5
	1.8 i 16V	4G67 [DOHC] Cat	100/136	04.1989	05.1992	RC 62 LS5	A24		1,1	L65-5
	1.8 i 16V	4G93 [DOHC] Cat	103/140	10.1994	08.1996	RFC 52 LS5	A26	B24	1,1	F54-5
	1.8 i 16V	4G93 GDI	92/125	08.1998	05.2000	RFC 52 LS5	A26	B24	1,1	F54-5
	1.8 i Hatchback	4G37 Cat	62/84	11.1987	05.1990	RC 62 LS5	A24		1,1	L65-5
	2.0 i	4G63 [SOHC]	82/112	11.1987	10.1992	RC 72 LS	A32	B26	1,0	L87
	2.0 i 16V	4G63 [SOHC] Cat	100/136	10.1996		RC 62 LS5	A24		1,1	L65-5
	2.0 i 16V, 4WD, Hatchback	4G63 [DOHC] Cat	106/144	11.1987	10.1992	RC 72 LS	A32	B26	1,0	L87

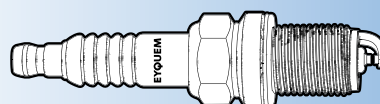

(1) Available until end of stock

- (a) 30 000 km
- (b) 60 000 km
- (c) Grey sticker on ignition coil
- (d) Green sticker on ignition coil

- (e) Hex 21 mm
- (f) Hex 16 mm
- (g) Recommended for cold weather



kW/HP



Box
10

Blister
4



F3-1

MITSUBISHI

	2.0 i 16V 4WD	4G63 [SOHC] Cat	101/137	11.1992	05.1996	RC 62 LS	A6	B17	0,8	L65
	2.0 i 4WD, 4WS, Hatchback	4G63 [SOHC] Cat	80/109	06.1990	10.1992	RC 62 LS5	A24		1,1	L65-5
	2.4 i	4G64 [DOHC] Cat	82/112	01.1994		RC 62 LS5	A24		1,1	L65-5
	2.4 i	4G64 [SOHC] Cat	82/112	01.1994		RFC 58 LS5	A38	B48	1,1	F54-5
	2.5 i 24V 4WD	4G73 [DOHC] Cat	125/170	11.1992	05.1996	RFC 58 LS5	A38	B48	1,1	F54-5
	3.0 i 24V	6G 72 [SOHC] Cat	111/150		10.1992	RC 62 LS5	A24		1,1	L65-5
GALANT - ETERNA SIGMA	1.6 GL, GS, SL	4G32		05.1976	04.1980	C 62 LS	A4	B5	1,0	L65
	1.8 5 GL, SL	G51B		08.1977	04.1980	RC 62 LS5	A24		1,1	L65-5
	1.8 i	G37B	66/90	09.1983	05.1989	RC 62 LS5	A24		1,1	L65-5
	1.8 i	G62B	70/95	02.1988	05.1990	RC 62 LS5	A24		1,1	L65-5
	2.0	G63B Cat	62/84	09.1983		RC 62 LS5	A24		1,1	L65-5
	2.0	G63B	75/102	09.1983	11.1990	RC 62 LS5	A24		1,1	L65-5
	2.0 GL, GLX, GSL	G52B		08.1977	04.1980	RC 62 LS5	A24		1,1	L65-5
	2.0 GLX	4G52		05.1976	04.1980	C 62 LS	A4	B5	1,0	L65
	2.0 GSR	4G52		05.1976	04.1980	RC 62 LS5	A24		1,1	L65-5
	2.0 i V6	6G 71	92/125	10.1986	11.1990	RC 52 LS5	A36	B38	1,1	L65-5
	3.0 V6	6G 72		10.1986	11.1990	RC 52 LS5	A36	B38	1,1	L65-5
GALANT VI	2.5 V6 24V (EA5A)	6A13	120/163	09.1996	09.2000	RFC 62 LSDP5	A507		1,1	
	2.5 V6 24V (EA5A)	6A13	118/160	09.2000	10.2004	RFC 62 LSDP5	A507		1,1	
GALANT VI Station Wagon	2.5 V6 24V (EA5W)	6A13	120/163	09.1996	09.2000	RFC 62 LSDP5	A507		1,1	
	2.5 V6 24V (EA5W)	6A13	118/160	09.2000	10.2003	RFC 62 LSDP5	A507		1,1	
GALLOPER	3.0 i V6	G6AT	104/141	01.1998		RC 52 LS5	A36	B38	1,1	L65-5
GTO	3.0 i 24V	6G 72 [DOHC]	165/224	10.1990		RFC 52 LS5	A26	B24	1,1	F54-5
	3.0 i V6 24V Tu	6G 72 Twin [DOHC]	206-210/280-286	10.1990		RFC 58 LS5	A38	B48	1,1	F54-5
JEEP	2.0	4G52	75/102	01.1975	08.1989	C 62 LS	A4	B5	0,8	L65
	2.6	4G53	89/121	01.1982	08.1989	C 62 LS	A4	B5	0,8	L65
JUPITER	T33, T41					RC 62 LS	A6	B17	0,8	L65
L 200	1.6	4G32		11.1986	03.1995	RC 62 LS5	A24		1,1	L65-5
	2.0 4WD	4G63 [SOHC]		11.1986	05.1995	RC 62 LS	A6	B17	0,8	L65
	2.4 i	4G64 [SOHC] Cat	82/112	06.1990	11.1997	RC 62 LS5	A24		1,1	L65-5
	2.6 i 4WD	4G54 B Cat	76/103	11.1989	05.1995	RC 62 LS5	A24		1,1	L65-5
	3.0 i V6 4WD	6G 72 [SOHC] Cat	110/150	06.1990	05.1991	RC 52 LS5	A36	B38	1,1	L65-5
L 300	1.4	4G33		01.1994		C 62 LS	A4	B5	0,8	L65
	1.6	4G32	48-51/65-69	05.1980		RC 62 LS5	A24		1,1	L65-5
	1.6 4x4	G32B	48/65	06.1986	10.1986	RC 62 LS5	A24		1,1	L65-5
	1.8 4x4	4G62	72/98	04.1983	12.1985	RC 52 LS	A9	B20	0,8	L65
	1.8 4x4	4G62	60/82	08.1984	02.1987	RC 62 LS	A6	B17	0,8	L65
	2.0	4G63	66/90	11.1986	11.1988	RC 62 LS5	A24		1,1	L65-5
	2.0 16V	4G63 [SOHC] Cat	65/88	06.1994		RFC 58 LS5	A38	B48	1,1	F54-5
	2.0 4x4	4G63 [SOHC]	65-66/88-90	11.1986	06.1994	RC 62 LS	A6	B17	0,8	L65
	2.0 i 16V	4G63 [SOHC] Cat	85/115	06.1994		RC 62 LS	A6	B17	0,8	L65
	2.4 i 4x4	G64B Cat	80/109	11.1986	10.1988	RC 62 LS5	A24		1,1	L65-5
	2.4 i 4x4	4G64 [SOHC] Cat	82/112	11.1986		RC 62 LS5	A24		1,1	L65-5
L 400	2.0 i 16V	4G63 [DOHC] Cat	106/144			RFC 52 LS5	A26	B24	1,1	F54-5
	2.4 i	4G64 [SOHC] Cat	82/112	01.1995		RFC 52 LS5	A26	B24	1,1	F54-5
LANCER	1.2	4G11	41/56	08.1979	10.1983	RC 62 LS	A6	B17	0,8	L65
	1.2	4G16	40/54	11.1983	08.1984	RC 52 LS	A9	B20	0,8	L65
	1.2	4G16	40/54	09.1984	04.1988	RC 62 LS	A6	B17	0,8	L65
	1.2 E, EL, SL	4G42		01.1973	07.1979	C 52 LS	A1	B1	0,8	L65
	1.2 GL	4G36		01.1976	07.1979	C 52 LS	A1	B1	0,8	L65
	1.3	4G13 Cat	49-55/67-75	04.1988	07.1995	C 62 LS	A4	B5	1,0	L65
	1.3	4G13 Cat	45/61	04.1988	07.1995	RC 52 LS5	A36	B38	1,1	L65-5
	1.3	4G13	49-55/67-75	04.1988	10.1991	RC 62 LS5	A24		1,1	L65-5
	1.3, Fiore	G13B		02.1985	06.1992	RC 62 LS5	A24		1,1	L65-5
	1.3 i 12V	G13B	49/67	01.1983	09.1992	RC 62 LS5	A24		1,1	L65-5
	1.3 i 12V	4G13 [SOHC] Cat	55/75	05.1992		RC 52 LS5	A36	B38	1,1	L65-5
	1.3 i 12V GLi	4G13 [SOHC] Cat	55/75	09.1992	05.1996	RC 52 LS5	A36	B38	1,1	L65-5
	1.3 i 12V GLi, GLX	4G13 [SOHC] Cat	55/75	10.1995		RC 62 LS5	A24		1,1	L65-5
	1.4	4G12	50/68	08.1979	10.1983	RC 52 LS	A9	B20	0,8	L65
	1.4 GL	G12B	41/56	01.1979	12.1983	RC 62 LS	A6	B17	0,8	L65
	1.4 GL	G12B	50/68	01.1979	12.1983	RC 52 LS	A9	B20	0,8	L65
	1.4 GL, SL, GLX	4G33		01.1973	03.1979	C 52 LS	A1	B1	0,8	L65
	1.5	G15B Cat	51/69	11.1983	08.1990	RC 62 LS	A6	B17	0,8	L65
	1.5 12V	4G15	67/91	06.1992		RC 52 LS5	A36	B38	1,1	L65-5
	1.5 12V Station Wagon, Fiore	G15B Cat	51/69	06.1985	05.1992	RC 62 LS5	A24		1,1	L65-5

(1) Available until end of stock

(a) 30 000 km

(b) 60 000 km

(c) Grey sticker on ignition coil

(d) Green sticker on ignition coil

(e) Hex 21 mm

(f) Hex 16 mm

(g) Recommended for cold weather



EYQUEM



Box 10
Blister 4



F3 → 1

MITSUBISHI

	1.5 i	G15B	51/69	06.1985	04.1988	RC 62 LS5	A24		1,1	L65-5
	1.5 i	4G15 Cat	62-66/84-90	04.1988	10.1991	RC 62 LS	A6	B17	0,8	L65
	1.5 i Hatchback	4G15 Cat	62-66/84-90	05.1989	10.1991	RC 62 LS	A6	B17	0,8	L65
	1.6	4G32	62/84	08.1979	08.1984	RC 62 LS	A6	B17	0,8	L65
	1.6		66/90	02.1994		RFC 42 LS5	A83		0,9	F54-5
	1.6 16V		66/90	12.1995		RFC 42 LS5	A83		0,9	F54-5
	1.6 GL, GSL, GSR	4G32		11.1976	07.1979	C 62 LS	A4	B5	1,0	L65
	1.6 i 16V	4G92 [SOHC] Cat	66/90	11.1995		RC 62 LS5	A24		1,1	L65-5
	1.6 i 16V Hatchback	4G61 [DOHC] Cat	91-100/124-136	04.1988	09.1992	RC 62 LS	A6	B17	0,8	L65
	1.6 i 16V Hatchback, 4WD	4G92 [DOHC] Cat	83/113	05.1992		RFC 52 LS5	A26	B24	1,1	F54-5
	1.8 i 16V	4G67 [DOHC] Cat	100/136	11.1989	05.1992	RC 62 LS	A6	B17	0,8	L65
	1.8 i 16V	4G93 [DOHC] Cat	100-103/136-140	05.1992	11.1995	RFC 52 LS5	A26	B24	1,1	F54-5
	1.8 i 16V	4G93 [SOHC] Cat	92/125	06.1992	10.1996	RFC 52 LS5	A26	B24	1,1	F54-5
	1.8 i 16V Hatchback	4G93 [DOHC] Cat	103/140	06.1992	10.1995	RFC 52 LS5	A26	B24	1,1	F54-5
	1.8 i Hatchback 4WD	4G37 Cat	61-69-71/83-94-97	05.1989	05.1992	RC 62 LS5	A24		1,1	L65-5
	1.8 i Station Wagon 4WD	G37B	61-62/83-84	06.1986	09.1989	RC 62 LS5	A24		1,1	L65-5
	1.8 i Station Wagon 4WD	G37B	62/84	06.1986	09.1989	RC 62 LS	A6	B17	0,8	L65
	1.8 i Station Wagon 4WD	4G37 Cat	66/90	11.1986	05.1992	RC 62 LS	A6	B17	0,8	L65
	2.0 i 16V	4G63 [DOHC] Cat	106/144	10.1991	01.1994	RC 72 LS	A32	B26	0,8	L87
LANCER A	1.3	4G13	60/82	09.2003		RFC 58 LS5	A38	B48	1,1	F54-5
	1.6	4G18	72/98	09.2003		RFC 58 LS5	A38	B48	1,1	F54-5
LANCER SEDEIA / CEDIA	1.8 i 16V	4G93 GDI	92/125	05.2000		RFC 52 LS5	A26	B24	1,1	F54-5
LEGNUM	1.8 i 16V	4G93 GDI	92/125	08.1996	05.2000	RFC 52 LS5	A26	B24	1,1	F54-5
LIBERO	1.3 i 16V	4G13 Cat	64/87	05.1992		RFC 52 LS5	A26	B24	1,1	F54-5
	1.6 i 16V	4G92 [DOHC] Cat	83/113	10.1996		RFC 52 LS5	A26	B24	1,1	F54-5
	1.8 i 16V	4G93 [SOHC] Cat	92/125	05.1992		RFC 52 LS5	A26	B24	1,1	F54-5
	1.8 i 16V	4G93 [DOHC] Cat	103/140	01.1994		RFC 52 LS5	A26	B24	1,1	F54-5
MAGNA	2.4 i 16V, Wagon	4G64 [SOHC] Cat	105/143	01.1996		RFC 52 LS5	A26	B24	1,1	F54-5
	2.6	4G54	76/103	08.1988		RC 62 LS	A6	B17	0,8	L65
	3.0 i 24V, Wagon	6G 72 [SOHC] Cat	140/190	01.1996		RC 62 LS5	A24		1,1	L65-5
MINICA	660	3G 83 [SOHC]	30/41	01.1989	09.1993	RC 52 LS5	A36	B38	1,1	L65-5
	500 : 0.5	G23B	24-28/33-38	10.1984	12.1988	RC 62 LS	A6	B17	0,8	L65
	550 : 0.55 5	3G 81 [SOHC]	34/46	01.1989	09.1990	RC 62 LS	A6	B17	0,8	L65
MINICAB BRAVO	0.55	3G 81 [SOHC]	34/46	08.1987	02.1990	RC 62 LS	A6	B17	0,8	L65
MIRAGE	1.2	G11B				RC 62 LS	A6	B17	0,8	L65
	1.3	G13B Cat		09.1983	10.1992	RC 62 LS5	A24		1,1	L65-5
	1.3 i 16V	4G13 Cat	64/87	10.1987	10.1995	RFC 52 LS5	A26	B24	1,1	F54-5
	1.4	G12B				RC 62 LS	A6	B17	0,8	L65
	1.4 Turbo	4G12 T	77/105			RC 62 LS5	A24		1,1	L65-5
	1.5	G15B Cat	51/69	09.1983	05.1992	RC 62 LS5	A24		1,1	L65-5
	1.5	G15B	50/68			RC 62 LS	A6	B17	0,8	L65
	1.5 i	4G15 Cat	62/84	10.1987	10.1991	RC 62 LS5	A24		1,1	L65-5
	1.6 i 16V	4G61 [DOHC] Cat	91/124	10.1987	10.1991	RC 62 LS	A6	B17	0,8	L65
	1.6 i 16V	4G92 [DOHC] Cat	83/113	10.1991	10.1995	RFC 52 LS5	A26	B24	1,1	F54-5
	1.6 Turbo	G32B T				RC 72 LS	A32	B26	0,8	L87
	1.8 i	G37B	62/84	09.1986	10.1990	RC 62 LS5	A24		1,1	L65-5
	1.8 i	4G93 [SOHC] Cat	85/115	10.1995		RFC 52 LS5	A26	B24	1,1	F54-5
MIRAGE DINGO	1.3 i 16V	4G13 Cat	64/87	01.2000		RFC 52 LS5	A26	B24	1,1	F54-5
	1.8 i 16V	4G93 GDI	92/125	02.2000		RFC 52 LS5	A26	B24	1,1	F54-5
MONTERO	3.0 V6	6G 72				RC 52 LS5	A36	B38	1,1	L65-5
PAJERO	1.8 i 16V	4G93 GDI	92/125	06.1998		RFC 52 LS5	A26	B24	1,1	F54-5
	2.0	G63B	75/102			RC 62 LS	A6	B17	1,0	L65
	2.4 i	4G64 [SOHC] Cat	82/112	12.1990	09.1999	RC 62 LS5	A24		1,1	L65-5
	2.4 i 16V	4G64 [SOHC] Cat	107/145	09.1997		RC 62 LS5	A24		1,1	L65-5
	2.6	4G54	76/103	12.1982	08.1984	RC 62 LS	A6	B17	1,0	L65
	2.6	G54B Cat	79/107	12.1982	05.1986	RC 62 LS	A6	B17	1,0	L65
	2.6	4G54	76/103	09.1984	11.1990	RC 52 LS	A9	B20	0,8	L65
	2.6	G54B Cat	79/107	06.1986	11.1990	RC 62 LS5	A24		1,1	L65-5
	3.0 i 24V 12V	6G72 [SOHC] Cat	136/185	09.1997		RC 52 LS5	A36	B38	1,1	L65-5
	3.0 i V6	6G72 [SOHC]	104/141	11.1988	11.1990	RC 52 LS5	A36	B38	1,1	L65-5
	3.0 i V6	6G72 [SOHC] Cat	110/150	12.1990	09.1999	RC 52 LS5	A36	B38	1,1	L65-5
	3.0 V6 SPORT (K90)	6G72	130/177	06.1997	04.2000	RFN 58 LZDP5	A187		1,1	
	3.5 V6 24V (V2_W, V4_W)	-	153/208	06.1994	04.2000	RFN 58 LZDP5	A187		1,1	
PAJERO SPORT	3.0 V6 (K96W)	6G72	130/177	11.1998		RFN 58 LZDP5	A187		1,1	
	3.0 V6 (K96W)	6G72	125/170	06.2000		RFN 58 LZDP5	A187		1,1	

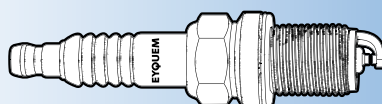

(1) Available until end of stock

- (a) 30 000 km
- (b) 60 000 km
- (c) Grey sticker on ignition coil
- (d) Green sticker on ignition coil

- (e) Hex 21 mm
- (f) Hex 16 mm
- (g) Recommended for cold weather



Box
10 Blister
4



F3-D1

mitsubishi

ROSA	2.4	4G53	62/84			C 62 LS	A4	B5	0,8	L65
RVR	1.8 i 16V	4G93 [DOHC] Cat	103/140	07.1991	11.1997	RFC 52 LS5	A26	B24	1,1	F54-5
	1.8 i 16V	4G93 GDI	92/125		11.1997	RFC 52 LS5	A26	B24	1,1	F54-5
	2.0 i 16V	4G63 [DOHC] Cat	106/144	07.1991	11.1997	RC 72 LS	A32	B26	0,8	L87
SAPPORO	1.6	4G32		03.1981	11.1984	RC 62 LS5	A24		1,1	L65-5
	1.6 GL, SL	4G32			02.1981	C 62 LS	A4	B5	1,0	L65
	2.0	4G63 [SOHC]		03.1981	11.1984	RC 62 LS	A6	B17	0,8	L65
	2.0	4G63 [SOHC]	69/94	03.1981	11.1984	RC 72 LS	A32	B26	0,8	L87
	2.0 GL, GLS, GSR	4G52		11.1976	05.1980	C 62 LS	A4	B5	1,0	L65
	2.0 GSR	4G63 GS		03.1981	11.1984	RC 72 LS	A32	B26	0,8	L87
	2.4 i	4G64 [SOHC]	91-95/124-129	06.1987	08.1988	RC 62 LS5	A24		1,1	L65-5
	2.4 i	4G64 [SOHC] Cat	91-95/124-129	09.1988		RC 72 LS5	A116		1,0	L87
SHOGUN	2.6	4G54	76/103	12.1982	08.1990	RC 62 LS	A6	B17	0,8	L65
SIGMA	2.0 i V6	6G71	92/125	10.1990		RC 52 LS5	A36	B38	1,1	L65-5
	3.0 V6	6G72	130/177	12.1990	07.1996	RC 62 LS5	A24		0,9	L65-5
	3.0 V6 (F16A)	6G72	151/205	12.1990	07.1996	RFN 58 LZDP5	A187		1,1	
SIGMA Station Wagon	3.0 (V6)	6G72 SOHC	125/170	01.1994	07.1996	RFN 58 LZDP5	A187		1,1	
SIGMA WAGON	3.0 (V6)	6G72 SOHC	125/170	01.1993	12.1993	RC 62 LS5	A24		0,9	L65-5
	3.0 i V6	6G72 [SOHC] Cat	125-130/170-177	01.1993		RC 32 LS5	A110		1,1	
SPACE GEAR	2.0 16V	4 G 63	85/115	05.1995		RFC 42 LS5	A83		0,9	F54-5
	2.0 16V	4 G 63	83/113	08.1996		RFC 42 LS5	A83		0,9	F54-5
	2.0 i 16V	4G69		01.1997		RFC 52 LS5	A26	B24	1,1	F54-5
	2.0 i 16V Van	4G63 [SOHC] Cat	83-85/113-115	12.1994		RFC 52 LS5	A26	B24	1,1	F54-5
	2.4 i	4G64	97/132	05.1995		RFC 42 LS5	A83		0,9	F54-5
	2.4 i 16V 4WD, Van 4WD	4G64 [SOHC] Cat	94-97/128-132	12.1994		RFC 52 LS5	A26	B24	1,1	F54-5
	2.4 i 4x4	4G64	97/132	05.1995		RFC 42 LS5	A83		0,9	F54-5
	SPACE RUNNER	1.8 i 16V GLXi	4G93 [SOHC] Cat	92/125	06.1991	05.1992	RFC 58 LS	A18		1,1
	1.8 i GLi, GLXi, GLXi 4x4	4G93 [SOHC] Cat	85-90/115-122	06.1991		RFC 58 LS5	A38	B48	1,1	F54-5
	2.0		100/136	08.1999		RFC 52 LS5	A26	B24	0,9	F54-5
	2.0 16V	4 G 63	98/133	06.1997	08.1999	RFC 52 LS5	A26	B24	0,9	F54-5
	2.0 i 16V	4G63 [SOHC] Cat	100/136	01.1999		RC 62 LS	A6	B17	0,8	L65
SPACE STAR	1.3 16V	4 G 13 (16 V)	63/86	06.1998		RFC 42 LS5	A83		0,9	F54-5
	1.3 16V		61/83	12.1998		RFC 42 LS5	A83		0,9	F54-5
	1.3 16V		60/82	09.2000		RFC 42 LS5	A83		0,9	F54-5
	1.3 i 16V	4G13 Cat	64/87	06.1998		RFC 52 LS5	A26	B24	1,1	F54-5
	1.8 GDI	4G93	90/122	06.1998	08.2002	RFC 42 LS5	A83		0,9	F54-5
SPACE WAGON	1.6	4G32 B	58/79	01.1984		RC 62 LS	A6	B17	0,8	L65
	1.8	4G37	66/90	10.1983	04.1991	RC 62 LS	A6	B17	0,8	L65
	1.8 i	4G93 [SOHC] Cat	85-88/115-120	05.1991	05.1992	RFC 58 LS	A18		1,1	F54
	1.8 i 16V 4WD	4G93 [SOHC] Cat	90/122	05.1991	05.1992	RFC 52 LS5	A26	B24	1,1	F54-5
	1.8 i Turbo	4G62 T ECI	100/136	01.1984	09.1985	RC 72 LS	A32	B26	0,8	L87
	2.0 4WD	G63B Cat	62/84	03.1985	04.1991	RC 62 LS5	A24		1,1	L65-5
	2.0 4WD	G63B	75/102	03.1985	04.1991	RC 62 LS5	A24		1,1	L65-5
	2.0 4WD	4G63 [SOHC]	69/94	06.1988	04.1991	RC 72 LS	A32	B26	0,8	L87
	2.0 4x4	4G63	75/102	06.1988	04.1991	RC 72 LS5	A116		0,9	L87
	2.0 GLXi	4G63	74/101	06.1988	04.1991	RC 72 LS5	A116		0,9	L87
	2.0 GLXi	4 G 63	98/133	10.1992	10.1998	RFC 52 LS5	A26	B24	1,1	F54-5
	2.0 GLXi 4x4	4G63	74/101	06.1988	04.1991	RC 72 LS5	A116		0,9	L87
	2.0 GLXi 4x4	4 G 63	98/133	10.1992	10.1998	RFC 52 LS5	A26	B24	1,1	F54-5
	2.0 i 16V 4WD	4G63 [SOHC] Cat	98/133	06.1992		RC 62 LS	A6	B17	0,8	L65
2.4 i 16V	4G64 [SOHC] Cat	97/132	06.1992		RFC 52 LS5	A26	B24	1,1	F54-5	
STARION	2.0 i Turbo Turbo Intercooler	4G63 T	110-125-127-132/ 150-170-173-	03.1982	05.1988	RC 72 L	A114		0,8	
	2.6 i Turbo Intercooler	G54B Cat	108-114/147-155	06.1986	05.1990	RC 62 LS5	A24		1,1	L65-5
TREDIA	1.4	4G33		09.1982	08.1988	RC 62 LS	A6	B17	0,8	L65
	1.4	4G12	50/68	12.1982	08.1984	RC 52 LS	A9	B20	0,8	L65
	1.4	G21B	52/71	09.1982	08.1988	RC 62 LS	A6	B17	0,8	L65
	1.5	4G15	55/75	09.1984	10.1985	RC 62 LS	A6	B17	0,8	L65
	1.6	4G32	55/75	10.1982	08.1984	RC 62 LS5	A24		1,1	L65-5
	1.6 Turbo	4G32 T	84-88/114-120	10.1982	08.1984	RC 62 LS	A6	B17	0,8	L65
	1.8 4WD	4G37	66-77/90-105	09.1984	09.1987	RC 62 LS5	A24		1,1	L65-5
	1.8 i Turbo	4G62 T ECI	100/136	09.1984	09.1985	RC 72 L	A114		0,8	
	2.0 4WD	G63B	75/102	09.1986		RC 62 LS5	A24		1,1	L65-5
VERADA	3.0 i V6	6G 72 [SOHC]	120/163	01.1991		RC 32 LS5	A110		1,1	

(1) Available until end of stock

(a) 30 000 km

(b) 60 000 km

(c) Grey sticker on ignition coil

(d) Green sticker on ignition coil

(e) Hex 21 mm

(f) Hex 16 mm

(g) Recommended for

cold weather



EYQUEM



Box 10
Blister 4



F3 → 1

MORGAN

4x4	1.6 1600	[DOHC]				C 72 LS (1)	A30		0,8	L87
	1.6 1600	[OHV]				RC 72 LS	A32	B26	0,8	L87
	1.6 1600	[OHC]				RFC 62 LS	A48		0,8	F86
PLUS EIGHT	3.5 i V8					RC 62 LS	A6	B17	0,8	L65
	3.5 V8			01.1969	12.1977	RC 62 LS	A6	B17	0,8	L65
	3.9 i V8					RC 62 LS	A6	B17	0,8	L65
	2.0	132 C 3000				RC 72 LS	A32	B26	0,8	L87
PLUS FOUR	2.0 i 16V	M16 i - T16 i [DOHC]	100-103/136-140			RFC 52 LS	A3	B16	0,8	F54

MOSKVITCH

2140	1.5			11.1974	12.1989	C 72 LS (1)	A30		0,7	L87
21412	1.5		51/69	05.1989		C 62 LS	A4	B5	0,9	L65
2141 - ALEKO	1.5		48/65	12.1986		RC 72 LS	A32	B26	0,7	L87
	1.5		52-54/71-73	12.1986		C 62 LS	A4	B5	0,7	L65
	1.6		52/71	12.1986		C 62 LS	A4	B5	0,7	L65
	1.6		56-59/76-80	12.1986		RC 62 LS	A6	B17	0,7	L65
	1.8		70/95	12.1986		RC 72 LS	A32	B26	0,7	L87
412, 427, 434					12.1976	C 62 LS	A4	B5	0,8	L65
ALEKO	2.0	F3R-...	83/113	01.1996		RC 52 LS	A9	B20	0,9	L65
ISH - 2126	1.5			09.1987		C 62 LS	A4	B5	0,7	L65
ZAZ 12 V4						C 42 S	A12	B7	0,8	N43

MURAT

124	Tous modèles (all models)					RC 62 LS	A6	B17	0,8	L65
131	Tous modèles (all models)					RC 62 LS	A6	B17	0,8	L65

NISSAN

100 NX	1.6 16V	GA16DS [DOHC] Cat	66-70/90-95	10.1990	10.1992	RFC 52 LS5	A26	B24	1,1	F54-5
	1.6 i 16V	GA16DE [DOHC] Cat	75-81/102-110	10.1992		RFC 52 LS	A3	B16	0,9	F54
	2.0 GTI	SR20DE	105/143	03.1991	10.1994	RFC 58 LZ	A50		0,9	F54
	2.0 i 16V	SR20DE [DOHC] Cat	105/143	10.1990		RFC 52 LS5	A26	B24	1,1	F54-5
180 B	1.6 Coupé	L16				RC 62 LS	A6	B17	0,9	L65
	1.8 16V			01.1988		RFC 58 LS5	A38	B48	1,1	F54-5
	1.8 Coupé	L18			12.1982	RC 62 LS	A6	B17	0,9	L65
	1.8 Turbo Coupé	L18T			12.1982	RC 62 LS	A6	B17	0,9	L65
180 SX	1.8 i 16V Turbo	CA18DET [DOHC]	124/169	04.1989	01.1991	RFC 58 LS5	A38	B48	1,1	F54-5
	2.0 i 16V	SR20DE [DOHC] Cat	105/143	08.1996		RFC 52 LS5	A26	B24	1,1	F54-5
200 SX	1.8 i 16V Turbo	CA18DT Cat [DOHC]	124/169	09.1988		RFC 52 LZDP5	A149		1,1	
	1.8 i 16V Turbo	CA18DT [DOHC]	124/169	09.1988		RFC 62 LS5	A42		1,1	F54-5
	1.8 i 16V Turbo	CA18DET [DOHC]	129/175	09.1988		RFC 58 LS5	A38	B48	1,1	F54-5
200 SX (S13)	1.8 Turbo	CA18DET	124/169	07.1988	11.1993	RFC 62 LSDP5	A507		1,1	
240 C, K, KGT	240 KGT : 2.4 Coupé	L24	83/113			RC 62 LS	A6	B17	0,9	L65
	260 Z : 2.6 Coupé	L26			12.1982	RC 62 LS	A6	B17	0,9	L65
280 ZX,ZXT	280 ZX : 2.8 i	L28E	114/155	10.1978	08.1984	RC 62 LS5	A24		1,1	L65-5
	280 ZX : 2.8 i Turbo Turbo	L28ET	147/200	09.1982	08.1984	RC 62 LS5	A24		1,1	L65-5
300 ZX	3.0 i	VG30	122/166	01.1984		RFC 58 LS5	A38	B48	1,1	F54-5
	3.0 Turbo		168/228	04.1984	10.1990	RFC 42 LS5	A83		0,9	F54-5
	3.0 Turbo	VG30ET	149/203	05.1987	10.1990	RFC 42 LS5	A83		0,9	F54-5
	3.0 Turbo Coupé	VG30T		02.1984		RFC 58 LS5	A38	B48	1,1	F54-5
	3.0 Twin Turbo	VG30DETT	208/283	05.1990	09.1995	RFN 58 LZDP5	A187		1,1	
	3.0 Twin Turbo	VG30DETT	197/268	05.1990	09.1995	RFN 58 LZDP5	A187		1,1	
350 Z	3.5	VQ35DE	206/280	10.2003		RFN 42 HZDP5	A184		0,9	
	3.5	VQ35DE	221/301	04.2006		RFN 42 HZDP5	A184		0,9	
350 Z Roadster	3.5	VQ35DE	206/280	03.2005		RFN 42 HZDP5	A184		0,9	
	3.5	VQ35DE	221/301	04.2006		RFN 42 HZDP5	A184		0,9	
AD / MAX	1.3	E13	44/60	05.1988	10.1990	RC 52 LS5	A36	B38	1,1	L65-5
	1.3	GA13DS		10.1990	05.1999	RFC 52 LS5	A26	B24	1,1	F54-5
	1.3 i 16V	GA13DE [DOHC] Cat	63/86	06.1995	05.1999	RFC 52 LS5	A26	B24	1,1	F54-5
	1.5	E15	63/86	05.1988	10.1990	RC 52 LS5	A36	B38	1,1	L65-5
	1.5 i 16V	GA15DE [DOHC] Cat	77/105	06.1995	05.1999	RFC 52 LS5	A26	B24	1,1	F54-5
	1.5 i 16V	QG15DE	66/90	05.1999		RFC 52 LS5	A26	B24	1,1	F54-5
	1.8 i 16V	QG18DE	84/114	05.1999		RFC 52 LS5	A26	B24	1,1	F54-5
ALMERA	1.4 i 16V Eco, Eco Pack, GX, LX, Papillon, S, SLX	GA14DE [DOHC] Cat	55-64/75-87	07.1995		RFC 52 LS	A3	B16	0,9	F54
	1.5	QG15DE	66/90	07.2000		RFC 42 LS5	A83		0,9	F54-5

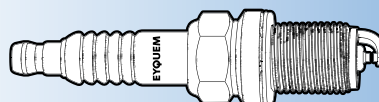

(1) Available until end of stock

- (a) 30 000 km
- (b) 60 000 km
- (c) Grey sticker on ignition coil
- (d) Green sticker on ignition coil

- (e) Hex 21 mm
- (f) Hex 16 mm
- (g) Recommended for cold weather



Box
10 Blister
4



F3

NISSAN

	1.5		72/98	10.2002		RFN 52 HZ	A157	B50	0,9	
	1.5 i 16V	QG15DE	66/90	02.2000		RFC 52 LS5	A26	B24	1,1	F54-5
	1.6 i 16V GX, SLX, SR, SR Deluxe	GA16DE [DOHC] Cat	66-72/90-98	09.1995		RFC 52 LS	A3	B16	0,9	F54
	1.8	QG18DE	84/114	07.2000		RFC 42 LS5	A83		0,9	F54-5
	1.8		85/115	10.2002		RFN 52 HZ	A157	B50	0,9	
	1.8 i 16V	QG18DE	84/114	02.2000	09.2002	RFC 52 LS5	A26	B24	1,1	F54-5
	2.0 GTi	SR20DE	105/143	07.1996	03.2000	RFC 58 LZ5	A101		0,9	F54-5
	2.0 i 16V GTi	SR20DE [DOHC] Cat	104/141	03.1996		RFC 52 LS5	A26	B24	1,1	F54-5
ALMERA II (N16)	NEW 1.5	QG15DE	72/98	10.2002		RFN 52 HZ5	A545		1,05	
	NEW 1.8	QG18DE	84/114	10.2002		RFN 52 HZ5	A545		1,05	
	NEW 1.8	QG18DE	85/116	10.2002		RFN 52 HZ5	A545		1,05	
ALMERA II Hatchback (N16)	NEW 1.5	QG15DE	72/98	10.2002		RFN 52 HZ5	A545		1,05	
	NEW 1.8	QG18DE	84/114	01.2000		RFN 52 HZ5	A545		1,05	
	NEW 1.8	QG18DE	85/116	10.2002		RFN 52 HZ5	A545		1,05	
ALMERA TINO	1.8	QG18DE	84/114	08.2000	02.2003	RFC 42 LS5	A83		0,9	F54-5
	1.8 i 16V	QG18DE	84/114	12.1998		RFC 52 LS5	A26	B24	1,1	F54-5
	2.0	SR20DE	100/136	08.2000		RFC 58 LZ5	A101		0,9	F54-5
	2.0 i 16V	SR20DE [DOHC] Cat	99-104/135-140	12.1998		RFC 52 LS5	A26	B24	1,1	F54-5
ALMERA TINO (V10)	NEW 1.8	QG18DE	84/114	01.2003		RFN 52 HZ5	A545		1,05	
	NEW 1.8	QG18DE	85/116	12.2002		RFN 52 HZ5	A545		1,05	
ATLAS	1.6	Z16	62/84	02.1982	01.1992	RC 62 LS	A6	B17	0,9	L65
	2.0	Z20	66/90	11.1986	06.1990	RC 52 LS5	A36	B38	1,1	L65-5
	2.0	NA20S		01.1992	06.1999	RC 52 LS5	A36	B38	1,1	L65-5
	2.0 i	KA 20 DE		06.1999		RFC 52 LS5	A26	B24	1,1	F54-5
AUSTER	1.6	CA16S	62/84	05.1985	02.1990	RFC 52 LS5	A26	B24	1,1	F54-5
	1.8 i	CA18i	67/91	05.1985	02.1990	RFC 52 LS5	A26	B24	1,1	F54-5
	1.8 i 16V	CA18DE	99/135	01.1985	02.1990	RFC 62 LS5	A42		1,1	F54-5
AVENIR / SALUT	1.6 16V	GA16DS [DOHC] Cat	66/90	05.1990	06.1999	RFC 52 LS5	A26	B24	1,1	F54-5
	1.8 i 16V	SR18DE [DOHC] Cat	103/140	01.1993	08.1995	RFC 52 LS5	A26	B24	1,1	F54-5
	1.8 i 16V	QG18DE	84/114	08.1998		RFC 52 LS5	A26	B24	1,1	F54-5
	2.0 i 16V	SR20DE [DOHC] Cat	105/143	11.1994	08.1998	RFC 52 LS5	A26	B24	1,1	F54-5
BASSARA	3.0 i V6 24V	VQ 30 DE Cat	142-147/193-200	11.1999		RFC 52 LZDP5	A149		1,1	
BLUEBIRD	1.6	CA16S	62/84	11.1983	12.1990	RFC 52 LS	A3	B16	1,1	F54
	1.6	CA16NS		01.1994		FC 52 LS	A2	B9	0,9	F54
	1.6 16V	GA16DS [DOHC] Cat	66/90	03.1991	01.1996	RFC 52 LS5	A26	B24	1,1	F54-5
	1.6 Station Wagon	L16	66-70/90-95	01.1980	05.1984	RC 52 LS	A9	B20	0,9	L65
	1.8	CA18S	74/101	11.1983	08.1989	FC 52 LS	A2	B9	0,9	F54
	1.8	CA18S	66-74/90-100	11.1983	08.1989	RC 62 LS	A6	B17	1,0	L65
	1.8 Coupé	L18S	65-77/88-105	01.1980	05.1984	RC 52 LS	A9	B20	0,9	L65
	1.8 i	CA18i	67/91	05.1988	09.1991	RFC 52 LS5	A26	B24	1,1	F54-5
	1.8 i 16V	CA18D	95/129	02.1989	12.1990	RFC 52 LZDP	A152		0,9	
	1.8 i 16V (RLT72)	CA18D	95/129	02.1989	12.1990	RFC 62 LSDP5	A507		1,1	
	1.8 i 16V	SR18DE [DOHC] Cat	103/140	09.1991	01.1996	RFC 52 LS5	A26	B24	1,1	F54-5
	1.8 i 16V	QG18DE	84/114	09.1998		RFC 52 LS5	A26	B24	1,1	F54-5
	1.8 i 16V Hatchback	CA18DE	99/135	11.1987	09.1991	RFC 62 LS5	A42		1,1	F54-5
	1.8 i 16V Hatchback	CA18D [DOHC] Cat	95/129	02.1989		RFC 62 LS5	A42		1,1	F54-5
	1.8 i 16V Turbo	CA18DET [DOHC]	124/169	09.1987	10.1989	RFC 58 LS5	A38	B48	1,1	F54-5
	1.8 i Turbo	CA18ET	100/136	11.1983	05.1990	RFC 62 LS5	A42		1,1	F54-5
	1.8 i Turbo	CA18T	88-99/120-135	12.1985		RFC 58 LS5	A38	B48	1,1	F54-5
	1.8 Station Wagon	L18S	65-77/88-105	01.1980	05.1984	RC 52 LS	A9	B20	0,9	L65
	1.8 Turbo Coupé	L18T	66-77/90-105	01.1980	05.1984	RC 62 LS	A6	B17	1,0	L65
	2.0, Hatchback	CA20S	75-77-81/102-105-110	11.1983		RFC 58 LS	A18		1,1	F54
	2.0 i	CA20E	77/105	04.1984	01.1988	RFC 42 LS5	A83		0,9	F54-5
	2.0 i	CA20E	77/105	12.1985	12.1990	RFC 42 LS5	A83		0,9	F54-5
	2.0 i, Break	L20B	81/110	01.1980	05.1984	RC 62 LS5	A24		1,1	L65-5
	2.0 i, Hatchback	CA20E Cat	77-85/105-115	01.1986		RFC 58 LS5	A38	B48	1,1	F54-5
	2.0 i 16V	SR20DE [DOHC] Cat	105/143	03.1991	01.1996	RFC 52 LS5	A26	B24	1,1	F54-5
	2.0 i 16V OZ	SR20DE [DOHC] Cat	105/143	05.1991	04.1992	RFC 52 LS5	A26	B24	1,1	F54-5
	2.0 i Coupé	LZ20E	81/110	01.1982	05.1984	RC 52 LS5	A36	B38	1,1	L65-5
	2.0 i Station Wagon	CA20E	77/105	04.1984	12.1990	RFC 42 LS5	A83		0,9	F54-5
BLUEBIRD SYLPHY	1.5 i 16V	QG15DE	66/90	08.2000		RFC 52 LS5	A26	B24	1,1	F54-5
	1.8 i 16V	QG18DE	84/114	08.2000		RFC 52 LS5	A26	B24	1,1	F54-5
CABSTAR	1.6	Z16	62/84	10.1986		C 52 LS	A1	B1	0,9	L65

(f) Available until end of stock

(a) 30 000 km

(b) 60 000 km

(c) Grey sticker on ignition coil

(d) Green sticker on ignition coil

(e) Hex 21 mm

(f) Hex 16 mm

(g) Recommended for cold weather



EYQUEM



Box
10

Blister
4



F3 → 1

NISSAN										
	2.0	Z20	66/90	03.1985		C 52 LS	A1	B1	0,9	L65
	2.0	NA20S	74/101	03.1985		RC 52 LS	A9	B20	1,0	L65
	2.0	Z20S	74/101	03.1985		RC 52 LS5	A36	B38	1,1	L65-5
	2.2	Z22	79/107	10.1986		C 62 LS	A4	B5	0,9	L65
	2.4	Z24	97/132	01.1987		C 62 LS	A4	B5	0,9	L65
	2.8	L28	97/132	10.1986		C 62 LS	A4	B5	0,9	L65
CARAVAN	2.0	Z20	66/90	09.1986	08.1995	RC 52 LS5	A36	B38	1,1	L65-5
	2.0	NA20S		08.1990	06.1999	RC 52 LS5	A36	B38	1,1	L65-5
	2.0 i	KA 20 DE		06.1999		RFC 52 LS5	A26	B24	1,1	F54-5
	3.0 i	VG30E	118/160	10.1988	09.1990	RFC 58 LS5	A38	B48	1,1	F54-5
	3.0 i	VG30E Cat	109/148	09.1990		RFC 58 LS5	A38	B48	1,1	F54-5
CEDRIC	2.0	CA20	81/110	01.1983		RC 62 LS5	A24		1,1	L65-5
	2.0	CA20S	77/105	06.1985	11.1995	RC 62 LS5	A24		1,1	L65-5
	2.0 200C	L20	71/97	03.1971	06.1979	RC 52 LS	A9	B20	0,8	L65
	2.0 i	VG20E	92/125	07.1987	06.1995	RFC 52 LS5	A26	B24	1,1	F54-5
	2.0 i 200C	L20E		03.1971	06.1979	RC 52 LS	A9	B20	0,8	L65
	2.0 i V6 24V Tu	VG20DET	136/185	06.1988	06.1991	RFC 58 LS5	A38	B48	1,1	F54-5
	2.4	L24	81/110	07.1979	06.1987	RC 62 LS5	A24		1,1	L65-5
	2.5 i V6 24V	VQ 25 DE Cat	140/190	06.1997	06.1999	RFC 52 LZDP5	A149		1,1	
	2.8 Break, Coupé	L28	92/125	07.1979	06.1987	RC 62 LS	A6	B17	0,9	L65
	3.0 i	VG30E	118/160	07.1987		RFC 58 LS5	A38	B48	1,1	F54-5
	3.0 i	VG30E Cat	109/148	06.1991	06.1995	RFC 58 LS5	A38	B48	1,1	F54-5
	3.0 i	VG30DE	136/185	06.1991	06.1995	RFC 52 LS5	A26	B24	1,1	F54-5
	3.0 i	VG30S		01.1993		RFC 58 LS5	A38	B48	1,1	F54-5
	3.0 i Turbo	VG30ET	144/196	07.1987	06.1991	RFC 58 LS5	A38	B48	1,1	F54-5
	3.0 i V6 24V	VQ 30 DE Cat	142-147/193-200	06.1995	06.1999	RFC 52 LZDP5	A149		1,1	
CEFIRO	2.0 i	RB20E	92/125	09.1988	08.1994	RFC 52 LS5	A26	B24	1,1	F54-5
	2.0 i 24V	RB20DE	114/155	09.1988	08.1994	RFC 52 LZDP5	A149		1,1	
	2.0 i 24V Turbo	RB20DET	151/205	09.1988	08.1994	RFC 58 LS5	A38	B48	1,1	F54-5
	2.0 i V6 24V	VQ 20 DE Cat	103/140	08.1994	12.1998	RFC 52 LZDP5	A149		1,1	
	2.5 i V6 24V	VQ 25 DE Cat	140/190	08.1994	12.1998	RFC 52 LZDP5	A149		1,1	
	3.0 i V6 24V	VQ 30 DE Cat	142-147/193-200	08.1994		RFC 52 LZDP5	A149		1,1	
CHERRY	1.0	E10	37/50	05.1982	05.1986	RC 52 LS	A9	B20	0,8	L65
	100 A : 1.0, Fil	A10		11.1979	02.1982	RC 52 LS	A9	B20	0,8	L65
	120 A : 1.2, Coupé, Fil Coupé, GL, GT	A12		10.1978	02.1982	RC 52 LS	A9	B20	0,8	L65
	1.3	E13	44-55/60-75	05.1982	05.1986	RC 52 LS	A9	B20	0,8	L65
	1.4	A14S	59/80	10.1979	04.1982	RC 52 LS	A9	B20	0,8	L65
	1.5	E15	51-63/69-86	05.1982	05.1986	RC 52 LS5	A36	B38	1,1	L65-5
	1.5 i Turbo Turbo Coupé	E15T	77-85/105-115	07.1983	05.1986	RC 62 LS	A6	B17	0,9	L65
	1.6	E16 Cat	51/69	06.1985	05.1986	RC 62 LS5	A24		1,1	L65-5
CIMA	3.0 i	VG30DE	136/185	01.1988	08.1991	RFC 52 LS5	A26	B24	1,1	F54-5
CREW	2.0 i	RB20E Cat	96/131	01.1994		RFC 52 LS5	A26	B24	1,1	F54-5
CUBE	1.3 i 16V	CG13DE [DOHC] Cat	55/75	02.1998	11.2001	RFC 52 LS5	A26	B24	1,1	F54-5
	1.6 16V (Z12)	HR16DE	81/110	03.2010		RWC 58 HSE5DP	A528		1,15	
ELGRAND	3.3 i V6	VG33E Cat	110/150	05.1997		RFC 52 LS5	A26	B24	1,1	F54-5
EXPERT	1.8 i 16V	QG18DE	84/114	06.1999		RFC 52 LS5	A26	B24	1,1	F54-5
FAIRLADY	2.6	L26		08.1973	08.1978	RC 62 LS	A6	B17	0,8	L65
FAIRLADY Z	2.0 i 24V Turbo	RB20DET	151/205	10.1985	07.1989	RFC 58 LS5	A38	B48	1,1	F54-5
	3.0 i	VG30DE	136/185	10.1986	07.1989	RFC 52 LS5	A26	B24	1,1	F54-5
	3.0 i Turbo	VG30ET	149/203	09.1983	07.1989	RFC 58 LS5	A38	B48	1,1	F54-5
FIGARO	1.0 i Turbo	MA10ET	62/84	02.1991	04.1992	RC 62 LS5	A24		1,1	L65-5
GLORIA	2.0	CA20S	77/105	06.1985	11.1995	RC 62 LS5	A24		1,1	L65-5
	2.0 i	VG20E	92/125	01.1996	06.1999	RFC 52 LS5	A26	B24	1,1	F54-5
	2.0 i V6 24V Tu	VG20DET	136/185	06.1988	06.1991	RFC 58 LS5	A38	B48	1,1	F54-5
	2.5 i V6 24V	VQ 25 DE Cat	140/190	06.1997	06.1999	RFC 52 LZDP5	A149		1,1	
	3.0 i	VG30E	118/160	06.1983	06.1991	RFC 58 LS5	A38	B48	1,1	F54-5
	3.0 i	VG30E Cat	109/148	06.1991	06.1995	RFC 58 LS5	A38	B48	1,1	F54-5
	3.0 i	VG30DE	136/185	06.1991	06.1995	RFC 52 LS5	A26	B24	1,1	F54-5
	3.0 i Turbo	VG30ET	144/196	07.1987	06.1991	RFC 58 LS5	A38	B48	1,1	F54-5
	3.0 i V6 24V	VQ 30 DE Cat	142-147/193-200	06.1995	06.1999	RFC 52 LZDP5	A149		1,1	
INFINITY	2.0 i 16V	SR20DE [DOHC] Cat	110/150	01.1994		RFC 58 LS	A18		1,1	F54
JUKE (F15)	NEW 1.2 DIG-T	HR12DDT	85/115	05.2014		RWN 42 HSIPS	A542		0,75	
	1.6	HR16DE	69/94	01.2013		RWC 58 HSE5DP	A528		1,15	
	1.6	HR16DE	86/117	06.2010		RWC 58 HSE5DP	A528		1,15	
KING CAB	2.0	Z20	64/87	01.1987		RC 62 LS	A6	B17	1,0	L65

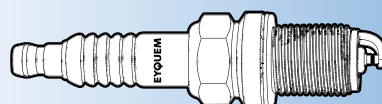

- (1) Available until end of stock
 (a) 30 000 km
 (b) 60 000 km
 (c) Grey sticker on ignition coil
 (d) Green sticker on ignition coil

- (e) Hex 21 mm
 (f) Hex 16 mm
 (g) Recommended for cold weather



KW/HP



Box
10

Blister
4



F3-D1

NISSAN

	2.4	Z24	74/101	01.1987		RC 62 LS	A6	B17	1,0	L65
KUBISTAR	1.2 16V	D4F712	55/75	04.2006		RWC 52 HSK	A197	B58	0,9	
LAUREL	1.8	CA18S	72/98	05.1988	08.1993	RFC 52 LS5	A26	B24	1,1	F54-5
	1.8 i	CA18i	67/91	01.1989	01.1993	RFC 52 LS5	A26	B24	1,1	F54-5
	2.0	L20A	71-95/97-129	01.1981		RC 52 LS	A9	B20	0,8	L65
	2.0	L20B	85/115	01.1981		RC 62 LS	A6	B17	0,9	L65
	2.0	CA20S	77/105	01.1985		RFC 58 LS5	A38	B48	1,1	F54-5
	2.0 i	RB20E	92/125	01.1981	08.1993	RFC 52 LS5	A26	B24	1,1	F54-5
	2.0 i 24V	RB20DE	114/155	01.1989	01.1993	RFC 52 LZDP5	A149		1,1	
	2.0 i 24V Turbo	RB20DET	151/205	10.1986	01.1993	RFC 58 LS5	A38	B48	1,1	F54-5
	2.0 i Turbo	VG20ET	114/155	10.1984	01.1989	RFC 58 LS5	A38	B48	1,1	F54-5
	2.4 Coupé	L24	83-88/113-120			RC 62 LS	A6	B17	0,9	L65
	2.4 Hardtop	L24S	81-94/110-128	01.1985		RC 62 LS	A6	B17	0,9	L65
	2.4 i	L24E	94/128	01.1981		RC 62 LS5	A24		1,1	L65-5
	2.4 i E	L24E	93/126	01.1985		RC 52 LS5	A36	B38	1,1	L65-5
	3.0 Hardtop	VG30S	122/166	01.1985		RFC 58 LS5	A38	B48	1,1	F54-5
	3.0 i E	VG30E Cat	112/152	03.1986		RFC 58 LS5	A38	B48	1,1	F54-5
LEOPARD	1.8	Z18	77/105	08.1984	03.1986	RC 52 LS5	A36	B38	1,1	L65-5
	2.0 i	L20E	92/125	01.1981	03.1986	RC 52 LS5	A36	B38	1,1	L65-5
	2.0 i	VG20E	85/115	08.1988	06.1992	RFC 52 LS5	A26	B24	1,1	F54-5
	2.0 i Turbo	L20ET	106/144	01.1981	03.1986	RC 52 LS5	A36	B38	1,1	L65-5
	2.0 i Turbo	VG20ET	114/155	01.1985		RFC 58 LS5	A38	B48	1,1	F54-5
	3.0 i Turbo	VG30ET	169/230	08.1984	03.1986	RFC 58 LS5	A38	B48	1,1	F54-5
	3.0 i Ultima	VG30DE	136/185	04.1986		RFC 52 LS5	A26	B24	1,1	F54-5
LEOPARDO	2.0 i	VG20E	85/115	01.1997	06.1999	RFC 52 LS5	A26	B24	1,1	F54-5
	2.0 i 24V Turbo	RB20DET	151/205	08.1988	06.1992	RFC 58 LS5	A38	B48	1,1	F54-5
	2.5 i V6 24V	VQ 25 DE Cat	140/190	10.1997	06.1999	RFC 52 LZDP5	A149		1,1	
	3.0 i	VG30DE	136/185	02.1986	06.1992	RFC 52 LS5	A26	B24	1,1	F54-5
	3.0 i	VG30E Cat	109/148	03.1996	12.1997	RFC 58 LS5	A38	B48	1,1	F54-5
	3.0 i V6 24V	VQ 30 DE Cat	142-147/193-200	03.1996	06.1999	RFC 52 LZDP5	A149		1,1	
LYBERTA	1.6	CA16S	66/90	07.1986		RFC 58 LS5	A38	B48	1,1	F54-5
	1.8 i Turbo	CA18ET	100/136	07.1986		RFC 58 LS5	A38	B48	1,1	F54-5
	2.0	CA20S	77/105	07.1986		RC 62 LS5	A24		1,1	L65-5
	2.0 i	CA20E Cat	74-77/100-105	07.1986		RFC 58 LS5	A38	B48	1,1	F54-5
M 10	2.0 i 4WD	CA20E Cat	74/101	03.1985		RFC 58 LS5	A38	B48	1,1	F54-5
MAXIMA	3.0 i	VG30E	125/170	08.1991		RFC 58 LS5	A38	B48	1,1	F54-5
	3.0 i	VG30DE	136/185	08.1991	08.1994	RFC 52 LS5	A26	B24	1,1	F54-5
	3.0 i GL, SLX	VG30E Cat	125-128/170-174	10.1988	08.1991	RFC 58 LS5	A38	B48	1,1	F54-5
MAXIMA QX	2.0	VQ20DE	103/140	02.1995	08.2000	RFN 58 LZDP5	A187		1,1	
	2.0	VQ20DE	103/140	02.1995	08.2000	RFC 62 LSDP5	A507		1,1	
	2.0 i V6 24V	VQ 20 DE Cat	103/140	10.1994		RFC 52 LZDP5	A149		1,1	
	2.0 V6 24V	VQ20DE	103/140	03.2000		RFN 58 LZDP5	A187		1,1	
	2.0 V6 24V	VQ20DE	103/140	03.2000		RFC 62 LSDP5	A507		1,1	
	2.5 i V6 24V	VQ 25 DE Cat	140/190	10.1994		RFC 52 LZDP5	A149		1,1	
	2.5 V6 24V	VQ25DE	140/190	02.1995	08.2000	RFC 62 LSDP5	A507		1,1	
	2.5 V6 24V	VQ25DE	154/209	03.2000		RFC 62 LSDP5	A507		1,1	
	3.0	VQ30DE	142/193	01.1995	08.2000	RFN 58 LZDP5	A187		1,1	
	3.0	VQ30DE	142/193	01.1995	08.2000	RFC 62 LSDP5	A507		1,1	
	3.0 i V6 24V	VQ 30 DE Cat	142-147/193-200	10.1994		RFC 52 LZDP5	A149		1,1	
	3.0 V6 24V	VQ30DE	147/200	03.2000		RFN 58 LZDP5	A187		1,1	
	3.0 V6 24V	VQ30DE	147/200	03.2000		RFC 62 LSDP5	A507		1,1	
MAXIMA Station Wagon	2.0 QX	VQ20DE	103/140	10.1997		RFC 62 LSDP5	A507		1,1	
	2.5 V6 24V	VQ25DE	140/190	10.1997		RFC 62 LSDP5	A507		1,1	
	3.0 QX	VQ30DE	142/193	10.1997		RFC 62 LSDP5	A507		1,1	
MICRA / MARCH	1.0 DX, GL, GLX, GS, GSX	MA10S	40/54	12.1982	07.1992	RC 32 LS5	A110		1,1	
	1.0 i 16V	CG10DE	40/54	08.1992	09.2000	RFC 42 LS5	A83		0,9	F54-5
	1.0 i 16V	CG10DE	44/60	09.2000	02.2003	RFC 42 LS5	A83		0,9	F54-5
	1.0 i 16V L, LX, Cypia, Lagoon, Stars Cup	CG10DE [DOHC] Cat	40/54	08.1992		RFC 52 LS5	A26	B24	1,1	F54-5
	1.0 i Turbo	MA10ET	62/84	03.1985		RC 62 LS5	A24		1,1	L65-5
	1.0 L, LX, SGL	MA10S	37-40/50-54	12.1982	07.1992	RC 52 LS	A9	B20	1,0	L65
	1.0 L, LX, SGL	MA10S Cat	37-40/50-54	12.1982	07.1992	RC 52 LS5	A36	B38	1,1	L65-5
	1.2 16V		48/65	01.2003		RFN 52 HZ	A157	B50	0,9	
	1.2 16V		59/80	01.2003		RFN 52 HZ	A157	B50	0,9	
	1.2 GS, GSX, LX, SLX, Super S	MA12S Cat	40-42/54-57	01.1986	07.1992	RC 52 LS5	A36	B38	1,1	L65-5

(f) Available until end of stock

(a) 30 000 km

(b) 60 000 km

(c) Grey sticker on ignition coil

(d) Green sticker on ignition coil

(e) Hex 21 mm

(f) Hex 16 mm

(g) Recommended for cold weather



EYQUEM



Box 10
Blister 4



F3-1

NISSAN											
		1.2 GS, GSX, LX, SLX, Super S	MA12S	44/60	07.1986	11.1988	RC 52 LS5	A36	B38	1,1	L65-5
		1.2 GS, GSX, LX, SLX, Super S	MA12S	44/60	12.1988	07.1992	RC 52 LS	A9	B20	1,0	L65
		1.3 i 16V	CG13DE	55/75	08.1992	09.2000	RFC 42 LS5	A83		0,9	F54-5
		1.3 i 16V LX, Plaza, SLX, Super S, Stars Cup, Tivoli	CG13DE [DOHC] Cat	55/75	08.1992	11.2001	RFC 52 LS5	A26	B24	1,1	F54-5
		1.4 16V		65/88	01.2003		RFN 52 HZ	A157	B50	0,9	
		1.4 i 16V	CGA3DE	60/82	09.2000	02.2003	RFC 42 LS5	A83		0,9	F54-5
MICRA C+C	NEW	1.4 16V	CR14DE	65/88	08.2005		RFN 42 HZP5	A512		1,1	
		1.6 160 SR	HR 16 DE	81/110	08.2005		RWC 58 HSE5DP	A528		1,15	
MICRA III	NEW	1.0 16V	CG10DE	48/65	01.2003		RFN 42 HZP5	A512		1,1	
	NEW	1.2 16V	CR12DE/CG12DE	59/80	01.2003		RFN 42 HZP5	A512		1,1	
	NEW	1.2 16V	CR12DE/CG12DE	48/65	01.2003		RFN 42 HZP5	A512		1,1	
	NEW	1.4 16V	CR14DE	65/88	01.2003		RFN 42 HZP5	A512		1,1	
		1.6 160 SR	HR 16 DE	81/110	05.2005	06.2010	RWC 58 HSE5DP	A528		1,15	
MICRA IV		1.2	HR 12DE	59/80	05.2010		RWC 58 HSE5DP	A528		1,15	
		1.2 DIG	HR12 DDR	72/98	04.2011		RWC 58 HSE5DP	A528		1,15	
MICRA V (K14)	NEW	1.0	BR10DE- B4D 410	52/71	12.2016		RWC 42 HSEW	A555		0,9	
	NEW	1.0	BR10DE- B4D 410	54/73	12.2016		RWC 42 HSEW	A555		0,9	
MURANO		3.5 4x4	VQ35DE	173/235	03.2005		RFN 42 HZDP5	A184		0,9	
		3.5 4x4	VQ35DE	188/256	10.2008		RFN 42 HZDP5	A184		0,9	
NOTE	NEW	1.4	CR14DE	65/88	03.2006		RFN 42 HZP5	A512		1,1	
		1.6	HR 16 DE	81/110	03.2006		RWC 58 HSE5DP	A528		1,15	
NOTE (E12)		1.2	HR12DE	59/80	06.2013		RWC 58 HSE5DP	A528		1,15	
		1.2 DIG-S	HR12DE	72/98	06.2013		RWC 58 HSE5DP	A528		1,15	
NV 200		1.6	HR 16 DE	81/110	02.2010		RWC 58 HSE5DP	A528		1,15	
NV 200 EVALIA		1.6	HR 16 DE	81/110	07.2010		RWC 58 HSE5DP	A528		1,15	
PAO		1.0	MA10S	37/50	01.1989	02.1991	RC 32 LS5	A110		1,1	
PATHFINDER		2.0	Z20S				RC 62 LS	A6	B17	1,0	L65
		2.4	Z24S				RC 62 LS	A6	B17	1,0	L65
		2.4 i	Z24i	74/101			RC 52 LS	A9	B20	0,9	L65
		3.0 i	VG30i				RFC 52 LS5	A26	B24	1,1	F54-5
		3.0 i	VG30E Cat	109/148	01.1992		RFC 58 LZ	A50		0,8	F54
		3.3 i V6	VG33		01.1998		RFC 52 LS5	A26	B24	1,1	F54-5
		3.3 V6 4WD	VG33E	125/170	09.1997		RFC 42 LS5	A83		0,9	F54-5
		3.3 V6 4WD	VG33E	110/150	03.1998	10.2000	RFC 42 LS5	A83		0,9	F54-5
		3.5 V6 4WD	VQ35	162/220	11.2000	12.2004	RFN 42 HZDP5	A184		0,9	
PATROL		2.8	L28	88-99/120-135	07.1980	08.1989	RC 62 LS	A6	B17	0,9	L65
		3.0	RB30S		04.1989		RFC 52 LS	A3	B16	0,9	F54
		4.0	P40	101-110/137-150	11.1979	08.1988	RC 52 LS	A9	B20	0,9	L65
PATROL GR		4.2 GR	TB42S	125/170	08.1987		RC 52 LS	A9	B20	0,9	L65
		4.2 i GR	TB42E Cat	118-121/160-165	10.1991		RC 52 LS	A9	B20	0,9	L65
		4.2 i GR	RB42S		01.1993	12.1994	RC 52 LS	A9	B20	0,9	L65
PICK UP		1.2	A12		01.1974	12.1978	RC 52 LS	A9	B20	0,8	L65
		1.3	J13		01.1972	12.1978	RC 62 LS	A6	B17	0,8	L65
		1.5	J15		01.1979	12.1982	RC 62 LS	A6	B17	0,8	L65
		1.5	A15S [OHV]		01.1983		RC 52 LS	A9	B20	0,8	L65
		1.6	J16		08.1979	09.1985	RC 52 LS	A9	B20	0,8	L65
		1.6	Z16	62/84	09.1985	09.1989	RC 62 LS	A6	B17	0,8	L65
		1.8 4WD	L18	59/80	08.1979	08.1989	RC 52 LS	A9	B20	0,8	L65
		2.0	Z20S	64-66/87-90	09.1985	09.1989	RC 62 LS	A6	B17	0,8	L65
		2.0	Z20	64-66/87-90	09.1985		RC 52 LS5	A36	B38	1,1	L65-5
		2.0	NA20S		09.1989		RC 52 LS5	A36	B38	1,1	L65-5
		2.0 i	KA 20 DE		06.1999		RFC 52 LS5	A26	B24	1,1	F54-5
		2.2 4WD	Z22	71/97	04.1983	08.1989	C 62 LS	A4	B5	0,9	L65
		2.4	Z24	74/101	09.1985	04.1992	C 62 LS	A4	B5	0,9	L65
		2.4 i 12V (D21)	KA24E	91/124	04.1992	02.1998	RFC 58 LZP5	A186		1,1	
		2.4 i 12V 4WD (D21)	KA24E	93/126	04.1992	02.1998	RFC 58 LZP5	A186		1,1	
		2.4 i 4WD	Z24i Cat	74-76/100-103	08.1988	04.1992	RC 62 LS	A6	B17	0,8	L65
		2.4 i 4WD (D22)	KA24DE	98/133	03.2002		RFC 58 LZP5	A186		1,1	
		2.4 i,4WD (D22)	KA24E	88/120	02.1998		RFC 58 LZP5	A186		1,1	
		3.0 i	VG30E Cat	109/148	09.1990		RFC 58 LZ	A50		1,1	F54
PINTARA		2.0 i	CA20E [SOHC] Cat	78/106	01.1985	04.1992	RFC 42 LS5	A83		1,1	F54-5
PIXO		1.0	K10B	50/68	06.2009		RZC 62 LSDP5K	A518		1,1	
PRAIRIE		1.5 GL, SGL	E15S	51-52/69-71	09.1982	09.1988	RC 52 LS5	A36	B38	1,1	L65-5
		1.8	CA18S	66-74/90-100	02.1985	09.1988	RC 62 LS	A6	B17	1,0	L65

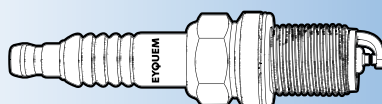

(1) Available until end of stock

- (a) 30 000 km
- (b) 60 000 km
- (c) Grey sticker on ignition coil
- (d) Green sticker on ignition coil

- (e) Hex 21 mm
- (f) Hex 16 mm
- (g) Recommended for cold weather



kW/HP



Box
10

Blister
4



F3-D1

NISSAN

	2.0 4WD	CA20S	67-68/91-92		09.1988	RC 62 LS	A6	B17	1,0	L65
	2.0 i 4WD	CA20E Cat	72/98	01.1986	09.1988	RFC 58 LS5	A38	B48	1,1	F54-5
	2.0 i, 4x4	CA20E	72/98	10.1988	12.1992	RFC 42 LS5	A83		0,9	F54-5
PRAIRIE / LIBERTY	2.0 i 16V	SR20DE [DOHC] Cat	105/143	08.1995	11.1998	RFC 52 LS5	A26	B24	1,1	F54-5
	2.0 i 16V	SR20DE [DOHC] Cat	107/145	08.1995	11.1998	RFC 58 LS	A18		1,1	F54
	2.0 i 4WD	CA20E Cat	98/133	01.1993		RFC 58 LS5	A38	B48	1,1	F54-5
	2.0 Pro, SLX, 4WD	CA20S	67-68/91-92	10.1988	08.1990	RC 62 LS	A6	B17	1,0	L65
PRAIRIE PRO	2.4 i, 4x4 (M11)	KA24E	98/133	04.1992	07.1994	RFC 58 LZ F5	A186		1,1	
PRESAGE	3.0 i V6 24V	VQ 30 DE Cat	142-147/193-200	06.1998		RFC 52 LZ DP5	A149		1,1	
PRESEA	1.5 i 16V	GA15DE [DOHC] Cat	77/105	01.1995		RFC 52 LS5	A26	B24	1,1	F54-5
	1.8 i 16V	SR18DE [DOHC] Cat	103/140	06.1992	01.1995	RFC 52 LS5	A26	B24	1,1	F54-5
PRESIDENT	2.0 i 16V	SR20DE [DOHC] Cat	105/143	06.1990	01.1995	RFC 52 LS5	A26	B24	1,1	F54-5
	4.4	Y44	147/200	10.1973	08.1989	RC 32 LS5	A110		1,1	
PRIMERA	4.4	Y44S		01.1993		C 32 LS	A31		0,9	L3
	1.6	GA16DE/GA16DS	66/90	06.1990	01.1996	RFN 52 LZ	A27		0,9	F54
	1.6	QG16DE	78/106	03.2002		RFN 52 HZ	A157	B50	0,9	
	1.6 16V	GA16DE	66/90	09.1996	05.1999	RFN 52 LZ	A27		0,9	F54
	1.6 16V	GA16DE	73/99	09.1996	10.2000	RFN 52 LZ	A27		0,9	F54
	1.6 16V	QG16DE	78/106	09.2000	12.2001	RFC 42 LS5	A83		0,9	F54-5
	1.6 16V Break, Wagon	GA16DS [DOHC] Cat	66-70/90-95	07.1990	04.1993	RFC 52 LS5	A26	B24	1,1	F54-5
	1.6 16V L, LS, LSX, LX, SLX	GA16DS [DOHC] Cat	66-70/90-95	06.1990		RFC 52 LS5	A26	B24	1,1	F54-5
	1.6 16V LX, SLX	GA16DS [DOHC] Cat	66/90	01.1993		RFC 58 LZ	A50		1,1	F54
	1.6 i 16V LX, SLX	GA16DE [DOHC] Cat	66-73-75/90-99-102	04.1993		RFC 52 LS	A3	B16	0,9	F54
	1.6 i Traveller	GA16DE/GA16DS	66/90	06.1993	03.1998	RFN 52 LZ	A27		0,9	F54
	1.8	QG18DE	85/115	03.2002		RFN 52 HZ	A157	B50	0,9	
	1.8 16V	QG18DE	84/114	08.1999		RFC 42 LS5	A83		0,9	F54-5
	1.8 i 16V	SR18DE [DOHC] Cat	103/140	09.1992	09.1995	RFC 52 LS5	A26	B24	1,1	F54-5
	1.8 i 16V	QG18DE	84/114	09.1998		RFC 52 LS5	A26	B24	1,1	F54-5
	1.8 Traveller		85/115	03.2002		RFN 52 HZ	A157	B50	0,9	
	2.0	QR20DE	103/140	03.2002		RFN 52 HZ	A157	B50	0,9	
	2.0 16V	SR20DI (SPI)	85/115	06.1990	01.1996	RFC 58 LZK (a)	A11	B29	0,9	F54
	2.0 16V	SR20DI (SPI)	85/115	09.1996		RFC 58 LZK (a)	A11	B29	0,9	F54
	2.0 16V 4x4	SR20DI (SPI)	85/115	04.1991	06.1996	RFC 58 LZK (a)	A11	B29	0,9	F54
	2.0 i	SR20DE	92/125	01.1995	06.1996	RFC 58 LZK (a)	A11	B29	0,9	F54
	2.0 i 16V	SR20DE EGI [DOHC] Cat	85/115	10.1991	11.1996	RFC 58 LZ	A50		0,9	F54
	2.0 i 16V	SR20DE [DOHC] Cat	85/115	02.1997		RFC 52 LS5	A26	B24	1,1	F54-5
	2.0 i 16V Break, Traveller, Wagon	SR20DI SPI [DOHC] Cat	85-112/115-152	06.1990		RFC 52 LS	A3	B16	0,9	F54
	2.0 i 16V GT, Hatchback	SR20DE [DOHC] Cat	110/150	06.1996		RFC 52 LS5	A26	B24	1,1	F54-5
	2.0 i 16V GT, Hatchback	SR20DEH [DOHC] Cat	110/150	06.1996		RFC 58 LZ	A50		0,9	F54
	2.0 i 16V GT, SGX, ZX, 4WD	SR20DE EGI [DOHC] Cat	85-112/115-152	06.1990	09.1995	RFC 58 LZ	A50		0,9	F54
	2.0 i 16V Hatchback	SR20DE [DOHC] Cat	85-92-96/115-125-131	09.1994		RFC 52 LS5	A26	B24	1,1	F54-5
	2.0 i 16V Hatchback	SR20DEL [DOHC] Cat	85-96/115-131	06.1996		RFC 58 LZ	A50		0,9	F54
	2.0 i Traveller	SR20DI (SPI)	85/115	07.1990	03.1998	RFC 58 LZK (a)	A11	B29	0,9	F54
	2.0 Traveller		103/140	03.2002		RFN 52 HZ	A157	B50	0,9	
PRIMERA (P12)	NEW 1.6	QG16DE	78/106	03.2002		RFN 52 HZ5	A545		1,05	
	NEW 1.8	QG18DE	85/115	03.2002		RFN 52 HZ5	A545		1,05	
PRIMERA Hatchback (P12)	NEW 2.0	QR20DE	103/140	03.2002		RFN 52 HZ5	A545		1,05	
	NEW 1.6	QG16DE	78/106	07.2002		RFN 52 HZ5	A545		1,05	
PRIMERA Break (WP12)	NEW 1.8	QG18DE	85/115	07.2002		RFN 52 HZ5	A545		1,05	
	NEW 2.0	QR20DE	103/140	07.2002		RFN 52 HZ5	A545		1,05	
PRIMERA Break (WP12)	NEW 1.6 Visia	QG16DE	80/109	01.2002		RFN 52 HZ5	A545		1,05	
	NEW 1.8	QG18DE	85/115	03.2002		RFN 52 HZ5	A545		1,05	
PULSAR	NEW 2.0	QR20DE	103/140	03.2002		RFN 52 HZ5	A545		1,05	
	1.0	E10	37-44/50-60	04.1982		RC 52 LS	A9	B20	0,8	L65
	1.3	E13	44-55/60-75	01.1980		RC 52 LS5	A36	B38	1,1	L65-5
	1.3	E13S	50/68	01.1980	08.1990	RC 52 LS5	A36	B38	1,1	L65-5
	1.3	GA13DS		08.1990	01.1995	RFC 52 LS5	A26	B24	1,1	F54-5
	1.4	GA14S	63/86	10.1988		RFC 58 LS	A18		0,9	F54
	1.5	E15	54-63/86	04.1982		RC 52 LS	A9	B20	0,8	L65
	1.5 i 16V	GA15DE [DOHC] Cat	77/105	01.1995		RFC 52 LS5	A26	B24	1,1	F54-5
	1.5 i Turbo	E15T	85/115	04.1982	05.1986	RC 62 LS	A6	B17	0,9	L65
	1.6	E16	62/84	04.1982		RC 62 LS	A6	B17	0,9	L65
	1.6	GA16S		10.1988		RFC 58 LS	A18		0,9	F54

(f) Available until end of stock

(a) 30 000 km

(b) 60 000 km

(c) Grey sticker on ignition coil

(d) Green sticker on ignition coil

(e) Hex 21 mm

(f) Hex 16 mm

(g) Recommended for cold weather



EYQUEM



Box 10
Blister 4



F3 → 1

NISSAN										
	1.6 4WD	E16S	62/84	06.1986		RC 62 LS	A6	B17	0,9	L65
	1.6 i 16V	CA16D [DOHC] Cat	81/110	02.1987	10.1988	RFC 58 LS5	A38	B48	1,1	F54-5
	1.6 i 16V	GA16DE [DOHC] Cat	86-88/117-120	08.1990	01.1995	RFC 52 LS5	A26	B24	1,1	F54-5
	1.6 i 4WD	E16I Cat	54-62/73-84	06.1986		RC 62 LS5	A24		1,1	L65-5
	1.8 i 16V	SR18DE [DOHC] Cat	103/140	08.1990	01.1995	RFC 52 LS5	A26	B24	1,1	F54-5
	1.8 i 16V 2WD	SR18DE [DOHC] Cat	103/140	01.1995		RFC 52 LS5	A26	B24	1,1	F54-5
	1.8 i 16V 4WD	SR18DE [DOHC] Cat	103/140	05.1996		RFC 52 LS5	A26	B24	1,1	F54-5
	1.8 i 16V Twin Cam	CA18D [DOHC] Cat	92/125	10.1988		RFC 62 LS5	A42		1,1	F54-5
	2.0 i 16V	SR20DE [DOHC] Cat	104-105/141-143	10.1991		RFC 58 LZ5	A101		1,1	F54-5
PULSAR (C13)	NEW 1.2 DIG-T	HR12DDT	85/115	10.2014		RWN 42 HSIPS	A542		0,75	
QASHQAI	1.6	HR 16 DE	86/117	11.2010		RWC 58 HSE5DP	A528		1,15	
	1.6	HR 16 DE	84/114	02.2007		RWC 58 HSE5DP	A528		1,15	
	2.0	MR 20 DE	104/141	11.2010		RWC 58 HSE5DP	A528		1,15	
	2.0	MR 20 DE	103/140	02.2007		RWC 58 HSE5DP	A528		1,15	
QASHQAI II (J11, J11)	NEW 1.2 DIG-T	HR12DDT	85/115	11.2013		RWN 42 HSIPS	A542		0,75	
RASHEEN	1.5 i 16V	GA15DE [DOHC] Cat	77/105	12.1994		RFC 52 LS5	A26	B24	1,1	F54-5
	1.8 i 16V	SR18DE [DOHC] Cat	103/140	01.1997		RFC 52 LS5	A26	B24	1,1	F54-5
	2.0 i 16V	SR20DE [DOHC] Cat	105/143	04.1998		RFC 52 LS5	A26	B24	1,1	F54-5
RNESSA	2.0 i 16V	SR20DE [DOHC] Cat	105/143	10.1997		RFC 52 LS5	A26	B24	1,1	F54-5
S CARGO	1.5	E15S	54/73	01.1989	12.1990	RC 52 LS5	A36	B38	1,1	L65-5
SAFARI	4.2	TB42S	125/170	09.1988	03.1998	RC 52 LS	A9	B20	0,9	L65
	4.2 i	TB42E Cat	118/160	11.1991	03.1998	RC 52 LS	A9	B20	0,9	L65
SANTANA	1.8 i	JN [SOHC]	67/91	01.1984		C 62 LS3X	A13	B15	0,8	L65
	2.0 i		77-92/105-125	01.1984		C 62 LS	A4	B5	0,7	L65
	2.0 i 20V	JZ [DOHC]	103-118/140-160	02.1987		FC 62 LS3X	A57		0,9	F86
SERENA	1.6 16V	GA16DE	71/97	02.1993		RFN 52 LZ	A27		0,9	F54
	2.0 16V	SR20DE	93/126	11.1992		RFC 58 LZK (a)	A11	B29	0,9	F54
SILVIA	1.8 i 16V Coupé	CA18DE	99/135	05.1988	01.1991	RFC 58 LS5	A38	B48	1,1	F54-5
	1.8 i 16V Turbo Coupé	CA18DET [DOHC]	124/169	02.1986	01.1991	RFC 58 LS5	A38	B48	1,1	F54-5
	1.8 i Turbo	CA18ET	90-100/122-136	10.1983	01.1989	RFC 58 LS5	A38	B48	1,1	F54-5
	2.0 i 16V	SR20DE [DOHC] Cat	105/143	01.1991	10.1993	RFC 52 LS5	A26	B24	1,1	F54-5
	2.0 i 16V Coupé	FJ20E	107-111/146-151	10.1983		RC 62 LS5	A24		1,1	L65-5
	2.0 i Turbo	CA20E	90-107/122-146	10.1983		RFC 58 LS5	A38	B48	1,1	F54-5
SKYLINE	1.8	L18		10.1977	08.1985	C 52 LS	A1	B1	0,9	L65
	1.8	CA18S	74/101	09.1985	11.1989	RC 52 LS	A9	B20	1,0	L65
	1.8	CA18S	74/101	11.1989	07.1993	RFC 52 LS5	A26	B24	1,1	F54-5
	1.8 i	CA18i	67/91	05.1989	07.1993	RFC 52 LS5	A26	B24	1,1	F54-5
	2.0	CA20S	72/98	09.1985	04.1989	RFC 58 LS	A18		1,1	F54
	2.0 i	RB20E	96/131	09.1985	08.1993	RFC 52 LS5	A26	B24	1,1	F54-5
	2.0 i 24V	RB20DE	114/155	08.1987	11.1989	RFC 52 LZDP5	A149		1,1	
	2.0 i 24V Turbo	RB20DET	151/205	05.1989	08.1993	RFC 58 LS5	A38	B48	1,1	F54-5
	2.0 i Turbo	RB20ET	125/170	09.1985	08.1987	RFC 58 LS5	A38	B48	1,1	F54-5
	2.4 Coupé	L24	83/113	09.1984	08.1985	RC 62 LS	A6	B17	0,9	L65
	2.4 i Coupé	L24E		10.1977	08.1985	RC 62 LS5	A24		1,1	L65-5
	2.8 6 cyl.	L28S				RC 62 LS	A6	B17	0,9	L65
STAGEA	2.0 i 24V	RB20DE	114/155	08.1997		RFC 52 LZDP5	A149		1,1	
STANZA	1.6	CA16S	60/82	08.1981	03.1986	RC 62 LS	A6	B17	1,0	L65
	1.6	CA16S	62/84	01.1986	02.1990	RFC 52 LS5	A26	B24	1,1	F54-5
	1.8 Coupé	CA18S	65-66/88-90	08.1981	03.1986	RC 62 LS	A6	B17	1,0	L65
	1.8 i	CA18i	67/91	05.1985	02.1990	RFC 52 LS5	A26	B24	1,1	F54-5
	1.8 i 16V	CA18DE	99/135	01.1985	02.1990	RFC 62 LS5	A42		1,1	F54-5
	2.0 Hatchback	CA20S	77/105	12.1985		RC 62 LS5	A24		1,1	L65-5
	2.0 i	CA20E Cat	77/105	06.1986		RFC 58 LS5	A38	B48	1,1	F54-5
SUNNY	1.0	E10S	37/50	01.1982		RC 52 LS	A9	B20	0,9	L65
	1.2 120Y, Coupé	A12	40-52/54-71	01.1970	02.1982	RC 52 LS	A9	B20	0,9	L65
	1.2 Truck	A12S	40-52/54-71	10.1989	03.1994	RC 52 LS	A9	B20	0,9	L65
	1.3	A13	55/75	01.1970	02.1982	RC 52 LS	A9	B20	0,9	L65
	1.3	E13S	44-49-55/60-67-75	03.1982	01.1990	RC 52 LS5	A36	B38	1,1	L65-5
	1.3	GA13DS		01.1990	01.1994	RFC 52 LS5	A26	B24	1,1	F54-5
	1.3 i 16V, Coupé	GA13DE [DOHC] Cat	63/86	01.1994	10.1998	RFC 52 LS5	A26	B24	1,1	F54-5
	1.4	GA14S	55-61-63/75-83-86	10.1988	08.1991	RFC 58 LS	A18		0,9	F54
	1.4 140Y Coupé, Traveller	A14	48-49/65-67	01.1970	02.1982	RC 52 LS	A9	B20	0,9	L65
	1.4 16V LX, SLX	GA14DS [DOHC] Cat	58-63/79-86	10.1990		RFC 52 LS	A3	B16	0,9	F54
	1.4 i 16V Hatchback	GA14DE [DOHC] Cat	55-60-64/75-82-87	10.1992		RFC 52 LS	A3	B16	0,9	F54

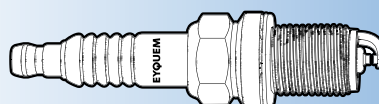

- (1) Available until end of stock
- (a) 30 000 km
- (b) 60 000 km
- (c) Grey sticker on ignition coil
- (d) Green sticker on ignition coil

- (e) Hex 21 mm
- (f) Hex 16 mm
- (g) Recommended for cold weather



KW/HP



Box
10

Blister
4



F3-1

NISSAN

	1.5	E15S	51-52-55-63/ 69-71-75-86	03.1982		RC 52 LS	A9	B20	0,9	L65
	1.5,Coupé	E15S	52/71	06.1986	10.1988	RC 52 LS5	A36	B38	1,1	L65-5
	1.5 i	A15	56-68/76-92	01.1970	02.1982	RC 52 LS	A9	B20	0,9	L65
	1.5 i 16V	GA15DE [DOHC] Cat	77/105	06.1995	05.1996	RFC 52 LS5	A26	B24	1,1	F54-5
	1.5 i 16V	QG15DE	66/90	10.1998		RFC 52 LS5	A26	B24	1,1	F54-5
	1.6 12V Coupe, 4x4	GA16S	62-66/84-90	10.1988		RFC 58 LS	A18		0,9	F54
	1.6 16V	GA16DS [DOHC] Cat	66/90	01.1991		RFC 52 LS5	A26	B24	1,1	F54-5
	1.6 16V Hatchback, 4x4	GA16DS [DOHC] Cat	70/95	10.1990		RFC 62 LS	A48		1,0	F86
	1.6 4WD, SLX	E16S	62/84	01.1986	08.1989	RC 62 LS	A6	B17	0,9	L65
	1.6 Combi	E16 Cat	51/69	03.1985		RC 52 LS5	A36	B38	1,1	L65-5
	1.6 i	SR16DE	67/91	01.1994		RFC 52 LS	A3	B16	0,9	F54
	1.6 i 12V 4WD	GA16i [OHC] Cat	66/90	10.1988		RFC 58 LS5	A38	B48	1,1	F54-5
	1.6 i 16V	CA16D [DOHC]	81-88/110-120	02.1987	12.1988	RFC 58 LS5	A38	B48	1,1	F54-5
	1.6 i 16V	GA16DE [DOHC] Cat	66/90	01.1990	01.1994	RFC 58 LS	A18		0,9	F54
	1.6 i 16V, Coupé	GA16DE [DOHC] Cat	88/120	01.1994	10.1998	RFC 58 LS5	A38	B48	1,1	F54-5
	1.6 i 16V 4WD	GA16DE [DOHC] Cat	66-75-81/90-102-110	10.1992		RFC 58 LS	A18		0,9	F54
	1.6 i 16V 4WD, Hatchback	GA16DE [DOHC] Cat	75-81/102-110	10.1992		RFC 58 LS	A18		0,9	F54
	1.6 i Coupé, 4WD	E16i Cat	54/73	01.1986		RC 62 LS5	A24		1,1	L65-5
	1.6 i Coupé, 4WD	E16i	62/84	01.1986		RC 52 LS5	A36	B38	1,1	L65-5
	1.6 GTI 16V	CA16D	81/110	02.1987	10.1988	RFN 58 LZDP5	A187		1,1	
	1.8 i	GA18DE		01.1995		RFC 58 LS5	A38	B48	1,1	F54-5
	1.8 i 16V	CA18D [DOHC] Cat	92-95/125-129	10.1988		RFC 58 LS5	A38	B48	1,1	F54-5
	1.8 i 16V	SR18DE [DOHC] Cat	103/140	10.1990	12.1995	RFC 52 LS5	A26	B24	1,1	F54-5
	1.8 i 16V, Coupé	SR18DE [DOHC] Cat	103/140	01.1994		RFC 52 LS5	A26	B24	1,1	F54-5
	1.8 GTI 16V	CA18D	92/125	01.1989	08.1990	RFN 58 LZDP5	A187		1,1	
	2.0 i	GA20DE	105/143	01.1993		RFC 58 LZ	A50		0,9	F54
	2.0 i 16V	SR20DE [DOHC] Cat	105/143	10.1990		RFC 52 LS5	A26	B24	1,1	F54-5
	2.0 i 16V	SR20DE	105/143	10.1990	05.1995	RFC 58 LZ	A50		0,9	F54
TERRANO	2.4 4WD (R20)	KA24E	85/115	05.1996	01.2002	RFC 58 LZFP5	A186		1,1	
	2.4 4WD (R20)	KA24E	87/118	05.1996		RFC 58 LZFP5	A186		1,1	
	2.4 i 12V 4WD (R20)	KA24E	91/124	02.1993	06.1996	RFC 58 LZFP5	A186		1,1	
TERRANO / REGULUS	2.4 i	Z24i	76/103	08.1987	07.1992	RC 52 LS	A9	B20	0,9	L65
	3.0 i	VG30i	95/129	08.1986	10.1989	RFC 52 LS5	A26	B24	1,1	F54-5
	3.0 i	VG30E Cat	109/148	11.1989	09.1995	RFC 58 LZ	A50		0,9	F54
	3.3 i V6	VG33E Cat	110-125/150-170	09.1995		RFC 52 LS5	A26	B24	1,1	F54-5
TIIDA	1.6	HR 16 DE	81/110	09.2007		RWC 58 HSE5DP	A528		1,15	
	1.8	HR 18 DE	93/126	09.2007		RWC 58 HSE5DP	A528		1,15	
TIIDA A	1.6	HR 16 DE	81/110	09.2007		RWC 58 HSE5DP	A528		1,15	
	1.8	HR 18 DE	93/126	09.2007		RWC 58 HSE5DP	A528		1,15	
URVAN	1.8	Z18	77/105	04.1982		RC 52 LS	A9	B20	1,0	L65
	2.0	H20	55/75	07.1980		RC 62 LS	A6	B17	0,8	L65
	2.0	Z20	64-66/87-90	07.1980		RC 52 LS5	A36	B38	1,1	L65-5
	2.0	Z20S	64-66/87-90	02.1987	07.1994	RC 52 LS	A9	B20	1,0	L65
	2.0	NA20S		01.1995		RC 52 LS5	A36	B38	1,1	L65-5
	2.4	Z24S	74/101	11.1986		RC 62 LS	A6	B17	0,8	L65
	2.4	Z24	74/101	09.1989		RC 62 LS5	A24		1,1	L65-5
	2.4 i	Z24i Cat	74-76/100-103	05.1989		RC 62 LS	A6	B17	0,8	L65
VANETTE (LARGO, CARGO, VAN)	1.2	A12		10.1978	06.1981	C 52 LS	A1	B1	0,8	L65
	1.2 Truck	A12S	40/54	11.1988	03.1994	RC 52 LS	A9	B20	0,9	L65
	1.2 Van	A12		10.1986	03.1994	RC 52 LS	A9	B20	0,9	L65
	1.4	A14		11.1980	05.1981	C 52 LS	A1	B1	0,8	L65
	1.5 Truck	A15S [OHV]	51/69	11.1988	03.1994	RC 52 LS5	A36	B38	1,1	L65-5
	1.5 Van	A15S [OHV]		05.1986	03.1994	RC 52 LS5	A36	B38	1,1	L65-5
	1.5 Van, Coach	A15 [OHV]	51/69	09.1985	04.1994	RC 52 LS5	A36	B38	1,1	L65-5
	1.6 i 16V Cargo	GA16DE [DOHC] Cat	71-72/97-98	07.1992		RFC 58 LS	A18		0,9	F54
	1.8 i Turbo Coach	CA18ET	99/135	05.1986	04.1993	RFC 58 LS5	A38	B48	1,1	F54-5
	2.0	Z20S	64/87	09.1986	08.1990	RC 52 LS5	A36	B38	1,1	L65-5
	2.0 Coach	CA20	81/110	09.1985	06.1991	RC 62 LS5	A24		1,1	L65-5
	2.0 Coach	CA20S	77/105	05.1986	04.1993	RC 62 LS5	A24		1,1	L65-5
	2.0 i	SR20E		01.1993		RFC 52 LS	A3	B16	0,8	F54
	2.0 Truck	NA20S		08.1990	03.1994	RC 52 LS5	A36	B38	1,1	L65-5
	2.4	Z203				RC 62 LS	A6	B17	0,8	L65
	2.4 i	Z24i	74-77/100-105	08.1986		RC 62 LS5	A24		1,1	L65-5

(f) Available until end of stock

(a) 30 000 km

(b) 60 000 km

(c) Grey sticker on ignition coil

(d) Green sticker on ignition coil

(e) Hex 21 mm

(f) Hex 16 mm

(g) Recommended for

cold weather



EYQUEM



Box
10

Blister
4



F3

NISSAN										
	2.4 i	Z24i Cat	74-77/100-105	09.1986		RC 52 LS	A9	B20	0,9	L65
VANETTE (SERENA)	1.6 16V	GA16DS [DOHC] Cat	66/90	06.1991	05.1194	RFC 52 LS5	A26	B24	1,1	F54-5
	1.6 i 16V	GA16DE [DOHC] Cat	71/97	05.1994		RFC 52 LS	A3	B16	0,9	F54
	2.0 i 16V	SR20DE [DOHC] Cat	92-93/125-126	06.1991	06.1999	RFC 52 LS5	A26	B24	1,1	F54-5
VIOLET	2.0 i 16V SLX	SR20DE [DOHC] Cat	93/126	06.1999		RFC 52 LS5	A26	B24	1,1	F54-5
	1.4 140J	A14		05.1977	10.1981	RC 52 LS	A9	B20	0,8	L65
	1.6 160J	L16S		01.1971	10.1981	RC 52 LS	A9	B20	0,8	L65
WINGROAD	1.6 160J SSS	L16T				RC 62 LS	A6	B17	0,8	L65
	1.5 i 16V	GA15DE [DOHC] Cat	77/105	05.1996	05.1999	RFC 52 LS5	A26	B24	1,1	F54-5
	1.5 i 16V	QG15DE	66/90	05.1999		RFC 52 LS5	A26	B24	1,1	F54-5
X-TRAIL (T30)	1.8 i 16V	SR18DE [DOHC] Cat	103/140	05.1996	05.1999	RFC 52 LS5	A26	B24	1,1	F54-5
	1.8 i 16V	QG18DE	84/114	05.1999		RFC 52 LS5	A26	B24	1,1	F54-5
	2.0	QR20DE	103/140	07.2001	01.2013	RFN 52 HZ5	A545		1,05	
X-TRAIL	2.0 4x4	QR20DE	103/140	07.2001	01.2013	RFN 52 HZ5	A545		1,05	
	2.5 4x4	QR25DE	121/165	09.2002	01.2013	RFN 52 HZ5	A545		1,05	
	2.0	MR 20 DE	103/140	06.2008		RWC 58 HSE5DP	A528		1,15	
	2.0	MR 20 DE	104/141	06.2007		RWC 58 HSE5DP	A528		1,15	
	2.0 FWD	MR 20 DE	104/141	06.2008		RWC 58 HSE5DP	A528		1,15	

OLCIT										
AXEL	1.1 11, R, RS, 12 TRS					C 72 LJS	A22		0,6	J87
SPECIAL						C 72 LJS	A22		0,6	J87

OLDSMOBILE										
ACHIEVA	2.3 i			01.1993		RFC 42 LS	A25		0,8	F54

OPEL										
ADAM	NEW 1.2	A 12 XEL/B 12 XEL	51/69	10.2012		RFN 42 LZG	A532		0,9	
	NEW 1.4	A 14 XEL	64/87	10.2012		RFN 42 LZG	A532		0,9	
	NEW 1.4	A 14 XER	74/101	10.2012		RFN 42 LZG	A532		0,9	
ADMIRAL A	2.6 S	26 S	74/101	04.1964	09.1965	RC 42 S	A69	B23	0,7	N43
	2.8 S	28 H - S	95-107/129-145	03.1969	01.1978	RC 42 S	A69	B23	0,7	N43
ADMIRAL B	2.8 S	28 S	95/129	03.1975	01.1978	RC 42 S	A69	B23	0,7	N43
	2.8 S	28 S	97/132	03.1969	07.1975	C 62 S	A55		0,7	
	2.8	28 H	103-107/140-146	03.1975	07.1976	RC 42 S	A69	B23	0,7	N43
AGILA A (H00)	2.8 E	28 E	118-121/160-165	07.1971	07.1976	RC 42 S	A69	B23	0,7	N43
	1.0 12V	Z 10 XE Ecotec [DOHC]	43/58	09.2000	12.2007	RFC 42 LZ2E	A5	B30	1,0	F54
	NEW 1.0	Z 10 XEP	44/60	08.2003	12.2007	RFN 42 LZG	A532		0,9	
AGILA B (H08)	1.2 16V	Z 12 XE Ecotec [DOHC]	55/75	09.2000	12.2007	RFC 42 LZ2E	A5	B30	1,0	F54
	NEW 1.2 16v Twin Sport	Z 12 XEP	59/80	07.2004	12.2007	RFN 42 LZG	A532		0,9	
	1.0	K10B	48/65	04.2008		RZC 62 LSDP5K	A518		1,1	
ANTARA	1.0 LPG	K10B	48/65	01.2010		RZC 72 LS	A508		0,9	
	1.0	K10B	50/68	07.2011		RZC 62 LSDP5K	A518		1,1	
	1.2	K12B	63/86	04.2008		RZC 62 LSDP5K	A518		1,1	
	1.2 LPG	K12B	63/86	04.2008		RZC 72 LS	A508		0,9	
	1.2	K12B	69/94	11.2010		RZC 62 LSDP5K	A518		1,1	
	2.4	Z 24 XED	104/141	05.2006		RFC 42 LZ2E	A5	B30	1,0	F54
ASCONA	2.4 LPG	Z 24 XE	103/140	09.2008		RFC 42 LZ2E	A5	B30	1,0	F54
	2.4 4x4	Z 24 XE	103/140	01.2007		RFC 42 LZ2E	A5	B30	1,0	F54
	2.4 LPG 4x4	Z 24 XE	103/140	10.2008		RFC 42 LZ2E	A5	B30	1,0	F54
ASCONA	1.2 S	12 N - S	40-44/54-60	04.1972	02.1979	RC 42 S	A69	B23	0,7	N43
	1.3 S	13 N - S [OHC]	44-55/60-75	03.1979	08.1981	RC 62 LS	A6	B17	0,7	L65
	1.6	16 N [OHC]	44/60	09.1975	08.1981	RC 42 S	A69	B23	0,7	N43
	1.6	16 N [OHC]	51-55/69-75	09.1975	08.1981	RC 62 LS	A6	B17	0,7	L65
	1.6 i	C 16 LZ [OHC I]	55/75	09.1986	08.1987	RC 62 LS5	A24		1,1	L65-5
	1.6 i	C 16 NZ - E 16 NZ [OHC]	55/75	09.1987	08.1988	RC 62 LS	A6	B17	0,7	L65
	1.6 i KAT	C 16 NZ	55/75	09.1986	08.1988	RC 52 LS	A9	B20	0,8	L65
	1.6 S	16 S [OHC]	55/75	09.1975	08.1981	RC 42 S	A69	B23	0,7	N43
	1.6 S	16 SH - 16 SV [OHC]	60-66/82-90	09.1981	08.1988	RC 62 LS	A6	B17	0,7	L65
	1.8 i	18 E - 18 SE [OHC]	74-85/100-115	09.1982	08.1988	RC 62 LS	A6	B17	0,7	L65
	1.8 i, E	C 18 NE [OHC]	74-85/100-115	09.1982	08.1988	RC 62 LS	A6	B17	0,7	L65
	1.8 i E	18 E [OHC]	74-85/100-115	09.1982	08.1986	RC 62 LS	A6	B17	0,7	L65
	1.8 S	E 18 NV [OHC II]	62/84	09.1987	08.1988	RC 62 LS	A6	B17	0,7	L65
1.9 S	19 N - S	55-66/75-90	03.1971	08.1981	RC 42 S	A69	B23	0,7	N43	
2.0 E, S	20 N - S	66-74/90-100	08.1977	08.1981	RC 42 S	A69	B23	0,7	N43	

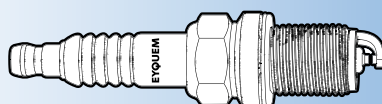

(1) Available until end of stock
 (a) 30 000 km
 (b) 60 000 km
 (c) Grey sticker on ignition coil
 (d) Green sticker on ignition coil

(e) Hex 21 mm
 (f) Hex 16 mm
 (g) Recommended for cold weather



Box
10

Blister
4



F3-1

OPEL

	2.0 i	20 NE [OHC]	85/115	09.1986	08.1988	RC 52 LS	A9	B20	0,8	L65
	2.0 i	20 SEH [OHC II]	95/129	03.1987	08.1988	RC 62 LS	A6	B17	0,7	L65
	2.0 i E, S	20 E	81/110	08.1977	08.1981	RC 42 S	A69	B23	0,7	N43
	400 : 2.0 16V E		103-106/140-144	08.1979	08.1981	C 72 LJS	A22		0,7	J87
ASTRA F (53, 54, 58, 59)	1.4 i	C 14 NZ [OHC]	44/60	09.1991	07.1995	RC 52 LS (e)	A9	B20	0,7	L65
	1.4	X 14 NZ [OHC I]	44/60	09.1991	07.1995	RC 52 LS (e)	A9	B20	0,7	L65
	1.4 i	C 14 NZ [OHC]	44/60	08.1995	01.1998	RFC 42 LZ2E (f)	A5	B30	1,0	F54
	1.4	X 14 NZ [OHC I]	44/60	08.1995	01.1998	RFC 42 LZ2E (f)	A5	B30	1,0	F54
	1.4	14 NV [OHC]	55/75	09.1991	09.1993	RFC 42 LZ2E (f)	A5	B30	1,0	F54
	1.4 Si	14 - C14 SE [OHC]	60/82	03.1992	07.1995	RC 52 LS (e)	A9	B20	0,7	L65
	1.4 Si	14 - C14 SE [OHC]	60/82	08.1995	03.1996	RFC 42 LZ2E (f)	A5	B30	1,0	F54
	1.4	14 SE	60/82	09.1992	01.1998	RFC 42 LZ2E (f)	A5	B30	1,0	F54
	1.4 i 16V	X 14 XE [DOHC]	66/90	02.1996	01.1998	RFC 42 LZ2E	A5	B30	1,0	F54
	1.6 i	X 16 SZ [OHC]	52/71	05.1993	12.1994	RC 52 LS (e)	A9	B20	0,7	L65
	1.6 i	X 16 SZ [OHC]	52/71	01.1995	07.1996	RFC 42 LZ2E (f)	A5	B30	1,0	F54
	1.6 i	C 16 NZ [OHC]	55/75	03.1992	07.1995	RC 52 LS (e)	A9	B20	0,7	L65
	1.6 i	C 16 NZ [OHC]	55/75	08.1995	01.1998	RFC 42 LZ2E (f)	A5	B30	1,0	F54
	1.6 i	16 NZR/ 16 LZ2 [OHC]	55/75	09.1995	01.1998	RFC 42 LZ2E	A5	B30	1,0	F54
	1.6 Si	C 16 SE [OHC]	74/100	03.1992	12.1994	RC 52 LS (e)	A9	B20	0,7	L65
	1.6 i 16V	X 16 XEL	74/100	08.1994	01.1998	RFC 42 LZ2E (f)	A5	B30	1,0	F54
	1.8 i, caravan	C 18 NZ	66/90	09.1991	01.1998	RC 52 LS	A9	B20	0,7	L65
	1.8 i, caravan	C 18 NZ	66/90	09.1991	01.1998	RFC 42 LZ2E (f)	A5	B30	1,0	F54
	1.8 i 16V	C 18 XEL/ X 18 XE [DOHC]	85-92/115-125	09.1994	01.1998	RFC 42 LZ2E	A5	B30	1,0	F54
	1.8 i 16V	C 18 XE	92/125	06.1993	08.1994	RFC 42 LZ2E	A5	B30	1,0	F54
	2.0 i, Caravan	C 20 NE	85/115	03.1992	07.1995	RC 52 LS	A9	B20	0,7	L65
	2.0 i, Caravan	C 20 NE	85/115	08.1995	09.1998	RFC 42 LZ2E	A5	B30	1,0	F54
	2.0 i 16V	X 20 XEV [DOHC]	100/136	01.1995	01.1998	RFC 42 LZ2E	A5	B30	1,0	F54
	2.0 i 16V GSi	C 20 XE	110/150	09.1991	01.1998	RFC 58 LZ2E	A10	B31	0,9	F54
	2.0 i 16V GSi	engine n°->14002934								
	2.0 i 16V GSi	C 20 XE	110/150	09.1991	01.1998	RFC 42 LZ2E	A5	B30	1,0	F54
	2.0 i 16V GSi	engine n° 14002935 ->								
ASTRA F (56, 57)	1.4 i	X 14 NZ [OHC I]	44/60	09.1991	07.1995	RC 52 LS (e)	A9	B20	0,7	L65
	1.4 i	C 14 NZ [OHC]	44/60	08.1995	01.1998	RFC 42 LZ2E (f)	A5	B30	1,0	F54
	1.4	14 NV [OHC]	55/75	09.1991	09.1993	RFC 42 LZ2E (f)	A5	B30	1,0	F54
	1.4 Si	C 14 SE	60/82	09.1992	09.1998	RC 52 LS (e)	A9	B20	0,7	L65
	1.4 Si	C 14 SE	60/82	09.1992	09.1998	RFC 42 LZ2E (f)	A5	B30	1,0	F54
	1.4	14 SE	60/82	09.1992	09.1998	RFC 42 LZ2E (f)	A5	B30	1,0	F54
	1.4 i 16V	X 14 XE	66/90	02.1996	09.1998	RFC 42 LZ2E	A5	B30	1,0	F54
	1.6 i	X 16 SZ	52/71	05.1993	12.1994	RC 52 LS (e)	A9	B20	0,7	L65
	1.6 i	X 16 SZ	52/71	01.1995	07.1996	RFC 42 LZ2E (f)	A5	B30	1,0	F54
	1.6	16 NZR/ 16 LZ2 [OHC]	55/75	09.1995	09.1998	RFC 42 LZ2E	A5	B30	1,0	F54
	1.6 Si	C 16 SE [OHC]	74/100	03.1992	12.1994	RC 52 LS (e)	A9	B20	0,7	L65
	1.6 i 16V	X 16 XEL	74/100	08.1994	09.1998	RFC 42 LZ2E (f)	A5	B30	1,0	F54
	1.8 i	C 18 NZ	66/90	09.1991	09.1998	RC 52 LS	A9	B20	0,7	L65
	1.8 i	C 18 NZ	66/90	09.1991	09.1998	RFC 42 LZ2E (f)	A5	B30	1,0	F54
	1.8 i 16V	18 SE	82/112	09.1995	09.1996	RFC 42 LZ2E (f)	A5	B30	1,0	F54
	1.8 i 16V	18 SEL	85/116	09.1995	08.1997	RFC 42 LZ2E (f)	A5	B30	1,0	F54
	1.8 i 16V	C 18 XEL/ X 18 XE [DOHC]	85/116	11.1994	09.1998	RFC 42 LZ2E (f)	A5	B30	1,0	F54
	1.8 i 16V	C 18 XE	92/125	06.1993	10.1994	RFC 42 LZ2E (f)	A5	B30	1,0	F54
	2.0 i	C 20 NE	85/115	03.1992	07.1995	RC 52 LS	A9	B20	0,7	L65
	2.0 i	C 20 NE	85/115	08.1995	09.1998	RFC 42 LZ2E	A5	B30	1,0	F54
	2.0 i	X 20 XEV	100/136	02.1995	09.1998	RFC 42 LZ2E	A5	B30	1,0	F54
ASTRA F Break (51, 52)	1.4 i	C 14 NZ [OHC]	44/60	09.1991	07.1995	RC 52 LS (e)	A9	B20	0,7	L65
	1.4 i	C 14 NZ [OHC]	44/60	08.1995	01.1998	RFC 42 LZ2E (f)	A5	B30	1,0	F54
	1.4	14 NV [OHC]	55/75	09.1991	09.1993	RFC 42 LZ2E (f)	A5	B30	1,0	F54
	1.4 Si	C 14 SE	60/82	09.1992	01.1998	RC 52 LS (e)	A9	B20	0,7	L65
	1.4 Si	C 14 SE	60/82	09.1992	01.1998	RFC 42 LZ2E (f)	A5	B30	1,0	F54
	1.4	14 SE	60/82	09.1992	01.1998	RFC 42 LZ2E (f)	A5	B30	1,0	F54
	1.4 i 16V	X 14 XE	66/90	02.1996	01.1998	RFC 42 LZ2E	A5	B30	1,0	F54
	1.6 i	X 16 SZ	52/71	05.1993	12.1994	RC 52 LS (e)	A9	B20	0,7	L65
	1.6 i	X 16 SZ	52/71	01.1995	07.1996	RFC 42 LZ2E (f)	A5	B30	1,0	F54
	1.6 i	C 16 NZ/X 16 SZR	55/75	09.1991	07.1995	RC 52 LS (e)	A9	B20	0,7	L65
	1.6 i	C 16 NZ/X 16 SZR	55/75	08.1995	01.1998	RFC 42 LZ2E (f)	A5	B30	1,0	F54
	1.6	16 NZR/ 16 LZ2 [OHC]	55/75	09.1995	01.1998	RFC 42 LZ2E	A5	B30	1,0	F54
	1.6 Si	C 16 SE [OHC]	74/100	03.1992	12.1994	RC 52 LS (e)	A9	B20	0,7	L65

(f) Available until end of stock

(a) 30 000 km

(b) 60 000 km

(c) Grey sticker on ignition coil

(d) Green sticker on ignition coil

(e) Hex 21 mm

(f) Hex 16 mm

(g) Recommended for cold weather



EYQUEM



Box
10

Blister
4



F3-1

OPEL										
	1.6 i 16V	X 16 XEL	74/100	08.1994	01.1998	RFC 42 LZ2E (f)	A5	B30	1,0	F54
	1.8 i	C 18 NZ	66/90	09.1991	07.1995	RC 52 LS	A9	B20	0,7	L65
	1.8 i	C 18 NZ	66/90	08.1995	01.1998	RFC 42 LZ2E (f)	A5	B30	1,0	F54
	1.8 i 16V	C 18 XEL/ X 18 XE [DOHC]	85/116	07.1994	01.1998	RFC 42 LZ2E (f)	A5	B30	1,0	F54
	1.8 i 16V	C 18 XE	92/125	06.1993	01.1998	RFC 42 LZ2E (f)	A5	B30	1,0	F54
	2.0 i	C 20 NE	85/115	09.1991	07.1994	RC 52 LS	A9	B20	0,7	L65
	2.0 i	X 20 XEV	100/136	02.1995	01.1998	RFC 42 LZ2E	A5	B30	1,0	F54
	2.0 i	C 20 XE	110/150	03.1993	01.1998	RFC 42 LZ2E	A5	B30	1,0	F54
ASTRA F Cabriolet (53_B)	1.4 Si	C 14 SE	60/82	03.1993	07.1995	RC 52 LS (e)	A9	B20	0,7	L65
	1.4 Si	C 14 SE	60/82	08.1995	03.2001	RFC 42 LZ2E (f)	A5	B30	1,0	F54
	1.4 i 16V	X 14 XE	66/90	01.1996	03.2001	RFC 42 LZ2E	A5	B30	1,0	F54
	1.6 i	X 16 SZ	52/71	03.1993	12.1994	RC 52 LS (e)	A9	B20	0,7	L65
	1.6 i	X 16 SZ	52/71	01.1995	08.1996	RFC 42 LZ2E (f)	A5	B30	1,0	F54
	1.6 i	X 16 SZR	55/75	01.1996	03.2001	RFC 42 LZ2E	A5	B30	1,0	F54
	1.8 i 16V	C 18 XEL/ X 18 XE [DOHC]	85/116	11.1994	03.2001	RFC 42 LZ2E (f)	A5	B30	1,0	F54
	2.0 i	C 20 NE	85/115	03.1993	10.1994	RC 52 LS	A9	B20	0,7	L65
ASTRA F Camionnette (55_)	1.4 i	C 14 NZ [OHC]	44/60	10.1991	07.1995	RC 52 LS (e)	A9	B20	0,7	L65
	1.4 i	C 14 NZ [OHC]	44/60	08.1995	01.1998	RFC 42 LZ2E (f)	A5	B30	1,0	F54
	1.6 i	C 16 NZ	55/75	10.1991	04.1993	RC 52 LS (e)	A9	B20	0,7	L65
	1.6 i	C 16 NZ	55/75	10.1991	04.1993	RFC 42 LZ2E (f)	A5	B30	1,0	F54
	1.6 i	X 16 SZ	52/71	02.1993	12.1994	RC 52 LS (e)	A9	B20	0,7	L65
	1.6 i	X 16 SZ	52/71	01.1995	07.1996	RFC 42 LZ2E (f)	A5	B30	1,0	F54
	1.6 i 16V	X 16 XEL	74/100	08.1994	01.1998	RFC 42 LZ2E (f)	A5	B30	1,0	F54
ASTRA F Classic 3/5 portes	1.4 i	X 14 NZ	44/60	01.1998	08.2002	RFC 42 LZ2E (f)	A5	B30	1,0	F54
	1.6 i	X 16 SZR	55/75	01.1998	08.2002	RFC 42 LZ2E (f)	A5	B30	1,0	F54
	1.6 i 16V	X 16 XEL	74/100	01.1998	08.2002	RFC 42 LZ2E (f)	A5	B30	1,0	F54
ASTRA F Classic A	1.4 i	X 14 NZ	44/60	01.1998	08.2002	RFC 42 LZ2E (f)	A5	B30	1,0	F54
	1.6 i	X 16 SZR	55/75	01.1998	08.2002	RFC 42 LZ2E (f)	A5	B30	1,0	F54
	1.6 i 16V	X 16 XEL	74/100	01.1998	08.2002	RFC 42 LZ2E (f)	A5	B30	1,0	F54
ASTRA F Classic Break	1.4 i	X 14 NZ	44/60	01.1998	01.2005	RFC 42 LZ2E (f)	A5	B30	1,0	F54
	1.6 i	X 16 SZR	55/75	01.1998	01.2005	RFC 42 LZ2E (f)	A5	B30	1,0	F54
	1.6 i 16V	X 16 XEL	74/100	01.1998	01.2005	RFC 42 LZ2E (f)	A5	B30	1,0	F54
ASTRA G 3/5 portes (F48_F08)	1.2 i 16V	X 12 XE [DOHC]	48/65	02.1998	09.2000	RFC 42 LZ2E	A5	B30	1,0	F54
	1.2 i 16V	Z 12 XE Ecotec [DOHC]	55/75	08.2000	01.2005	RFC 42 LZ2E	A5	B30	1,0	F54
	1.4	Z 14 XEP	66/90	09.2007	12.2009	RFC 52 LZE	A102		0,8	
	1.4 16V	Z 14 XE / X14 XE	66/90	02.1998	01.2005	RFC 42 LZ2E	A5	B30	1,0	F54
	1.6	X 16 SZR	55/75	02.1998	09.2000	RFC 42 LZ2E	A5	B30	1,0	F54
	1.6	Z 16 SE	62/84	09.2000	01.2005	RFC 42 LZ2E	A5	B30	1,0	F54
NEW	1.6 16v	X 16 XEL/Z 16 XE n°chassis 42000001->	74/101	02.1998	01.2005	RFN 42 LZG	A532		0,9	
	1.6 16v	X 16 XEL/Z 16 XE n°chassis ->42000000	74/101	02.1998	01.2005	RFC 42 LZ2E	A5	B30	1,0	F54
	1.6	Z 16 XEP	76/103	12.2002	08.2003	RFC 42 LZ4E	A154		1,6	
	1.6 LPG	Z 16 XEP	76/103	12.2002	08.2003	RFC 52 LZ4E	A159		1,6	
NEW	1.6	Z 16 XEP	76/103	09.2003	12.2009	RFN 42 LZG	A532		0,9	
	1.8 16V	X 18 XE1	85/116	02.1998	09.2000	RFC 42 LZ2E	A5	B30	1,0	F54
	1.8 16V	Z 18 XE	92/125	09.2000	01.2005	RFC 42 LZ2E	A5	B30	1,0	F54
	2.0 16V	X 20 XEV	100/136	02.1998	01.2005	RFC 42 LZ2E	A5	B30	1,0	F54
	2.0 i 16V OPC	X 20 XER [DOHC] Cat	118/160	11.1999	09.2002	RFC 42 LZ2E	A5	B30	1,0	F54
	2.0 OPC	Z 20 LET	141/192	09.2002	01.2004	RFC 42 LZ2E	A5	B30	1,0	F54
	2.0 OPC	Z 20 LET	147/200	11.2002	01.2004	RFC 42 LZ2E	A5	B30	1,0	F54
	2.2 i 16V	Z 22 SE Ecotec	108/147	06.2000	01.2005	RC 42 HJS3E5	A179		1,1	
ASTRA G A (F69_)	1.2 16V	X 12 XE	48/65	09.1998	09.2000	RFC 42 LZ2E	A5	B30	1,0	F54
	1.2 16V	Z 12 XE	55/75	09.2000	01.2005	RFC 42 LZ2E	A5	B30	1,0	F54
NEW	1.4	Z 14 XEP	66/90	09.2007	12.2009	RFN 42 LZG	A532		0,9	
	1.4 16V	Z 14 XE/ X 14 XE	66/90	09.1998	01.2005	RFC 42 LZ2E	A5	B30	1,0	F54
	1.6	X 16 SZR	55/75	09.1998	09.2000	RFC 42 LZ2E	A5	B30	1,0	F54
	1.6	Z 16 SE	62/84	09.2000	01.2005	RFC 42 LZ2E	A5	B30	1,0	F54
	1.6 16V	X 16 XEL/ Z 16 XE engine n°->42000000	74/101	02.1998	01.2005	RFC 42 LZ2E	A5	B30	1,0	F54

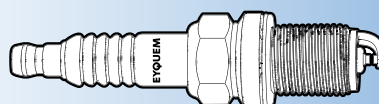

(1) Available until end of stock
 (a) 30 000 km
 (b) 60 000 km
 (c) Grey sticker on ignition coil
 (d) Green sticker on ignition coil

(e) Hex 21 mm
 (f) Hex 16 mm
 (g) Recommended for cold weather



KW/HP



Box
10

Blister
4



F3-1

OPEL

	NEW 1.6 16V	X 16 XEL/ Z 16 XE engine n°42000001->	74/101	02.1998	01.2005	RFN 42 LZG	A532		0,9		
	1.6	Z 16 XEP	76/103	12.2002	08.2003	RFC 42 LZ4E	A154		1,6		
	1.6 LPG	Z 16 XEP	76/103	12.2002	08.2003	RFC 52 LZ4E	A159		1,6		
	NEW 1.6	Z 16 XEP	76/103	09.2003	12.2009	RFN 42 LZG	A532		0,9		
	1.8 16V	X 18 XE1	85/116	09.1998	09.2000	RFC 42 LZ2E	A5	B30	1,0	F54	
	1.8 16V	Z 18 XE	92/125	06.2000	01.2005	RFC 42 LZ2E	A5	B30	1,0	F54	
	2.0 16V	X 20 XEV	100/136	09.1998	01.2005	RFC 42 LZ2E	A5	B30	1,0	F54	
	2.2 i 16V	Z 22 SE Ecotec	108/147	03.2001	01.2005	RC 42 HJS3E5	A179		1,1		
ASTRA G Break (F35_)	1.2 16V	X 12 XE	48/65	02.1998	09.2000	RFC 42 LZ2E	A5	B30	1,0	F54	
	1.2 16V	Z 12 XE	55/75	09.2000	07.2004	RFC 42 LZ2E	A5	B30	1,0	F54	
	NEW 1.4	Z 14 XEP	66/90	10.2004	12.2009	RFN 42 LZG	A532		0,9		
	1.4 16V	Z 14 XE/ X 14 XE	66/90	06.1998	07.2004	RFC 42 LZ2E	A5	B30	1,0	F54	
	1.6	X 16 SZR	55/75	02.1998	09.2000	RFC 42 LZ2E	A5	B30	1,0	F54	
	1.6	Z 16 SE	62/84	09.2000	07.2004	RFC 42 LZ2E	A5	B30	1,0	F54	
	1.6 16V	X 16 XEL/ Z 16 XE engine n°->42000000	74/101	02.1998	07.2004	RFC 42 LZ2E	A5	B30	1,0	F54	
	NEW 1.6 16V	X 16 XEL/ Z 16 XE engine n°42000001->	74/101	02.1998	07.2004	RFN 42 LZG	A532		0,9		
	1.6	Z 16 XEP	76/103	12.2002	08.2003	RFC 42 LZ4E	A154		1,6		
	1.6 LPG	Z 16 XEP	76/103	12.2002	08.2003	RFC 52 LZ4E	A159		1,6		
	NEW 1.6	Z 16 XEP	76/103	09.2003	07.2009	RFN 42 LZG	A532		0,9		
	1.8 16V	X 18 XE1	85/116	02.1998	09.2000	RFC 42 LZ2E	A5	B30	1,0	F54	
	1.8 16V	Z 18 XE	92/125	09.2000	07.2004	RFC 42 LZ2E	A5	B30	1,0	F54	
	2.0 16V	X 20 XEV	100/136	02.1998	07.2004	RFC 42 LZ2E	A5	B30	1,0	F54	
	2.0 OPC	Z 20 LET	141/192	09.2002	07.2004	RFC 42 LZ2E	A5	B30	1,0	F54	
	2.0 OPC	Z 20 LET	147/200	11.2002	07.2004	RFC 42 LZ2E	A5	B30	1,0	F54	
	2.2 i 16V	Z 22 SE Ecotec	108/147	03.2001	07.2004	RC 42 HJS3E5	A179		1,1		
ASTRA G Coupe (F07_)	1.6 16V	Z 16 XE engine n°->42000000	74/101	03.2000	05.2005	RFC 42 LZ2E	A5	B30	1,0	F54	
	NEW 1.6 16V	Z 16 XE engine n°42000001->	74/101	03.2000	05.2005	RFN 42 LZG	A532		0,9		
	1.6	Z 16 XEP	76/103	03.2000	08.2003	RFC 42 LZ4E	A154		1,6		
	1.6 LPG	Z 16 XEP	76/103	03.2000	08.2003	RFC 52 LZ4E	A159		1,6		
	NEW 1.6	Z 16 XEP	76/103	09.2003	05.2005	RFN 42 LZG	A532		0,9		
	1.8 16V	X 18 XE1	85/116	03.2000	10.2000	RFC 42 LZ2E	A5	B30	1,0	F54	
	1.8 16V	Z 18 XE	92/125	09.2000	05.2005	RFC 42 LZ2E	A5	B30	1,0	F54	
	2.0 16V Turbo	Z 20 LET	140/190	09.2000	08.2001	RFC 42 LZ2E	A5	B30	1,0	F54	
	2.0 16V Turbo	Z 20 LET	141/192	08.2001	05.2005	RFC 42 LZ2E	A5	B30	1,0	F54	
	2.0 16V Turbo	Z 20 LET	147/200	11.2002	01.2004	RFC 42 LZ2E	A5	B30	1,0	F54	
	2.2 i 16V	Z 22 SE Ecotec	108/147	09.2000	05.2005	RC 42 HJS3E5	A179		1,1		
ASTRA G Cabriolet (F67_)	1.6 16V	Z 16 XE engine n°->42000000	74/101	03.2001	10.2005	RFC 42 LZ2E	A5	B30	1,0	F54	
	NEW 1.6 16V	Z 16 XE engine n°42000001->	74/101	03.2001	10.2005	RFN 42 LZG	A532		0,9		
	1.6	Z 16 XEP	76/103	01.2003	08.2003	RFC 42 LZ4E	A154		1,6		
	1.6 LPG	Z 16 XEP	76/103	01.2003	08.2003	RFC 52 LZ4E	A159		1,6		
	NEW 1.6	Z 16 XEP	76/103	09.2003	10.2005	RFN 42 LZG	A532		0,9		
	1.8 16V	Z 18 XE	92/125	03.2001	10.2005	RFC 42 LZ2E	A5	B30	1,0	F54	
	2.0 OPC	Z 20 LET	141/192	03.2002	10.2005	RFC 42 LZ2E	A5	B30	1,0	F54	
	2.0 16V Turbo	Z 20 LET	147/200	11.2002	01.2004	RFC 42 LZ2E	A5	B30	1,0	F54	
	2.2 i 16V	Z 22 SE Ecotec	108/147	03.2001	10.2005	RC 42 HJS3E5	A179		1,1		
ASTRA G Camionnette (F70_)	1.6	X 16 SZR	55/75	01.1999	09.2000	RFC 42 LZ2E	A5	B30	1,0	F54	
	1.6	Z 16 SE	62/84	09.2000	04.2005	RFC 42 LZ2E	A5	B30	1,0	F54	
ASTRA H (L48)	NEW 1.2	Z 12 XEP	59/80	08.2005		RFN 42 LZG	A532		0,9		
ASTRA H (L48_)	NEW 1.4	Z 14 XEL	55/75	04.2004	10.2004	RFN 42 LZG	A532		0,9		
ASTRA H (L48)	NEW 1.4	Z 14 XEP	66/90	03.2004	10.2010	RFN 42 LZG	A532		0,9		
	NEW 1.6	Z 16 XE1 / Z 16 XEP	77/105	03.2004	10.2010	RFN 42 LZG	A532		0,9		
	NEW 1.6	A 16 XER / Z 16 XER	85/115	12.2006		RFN 42 LZG	A532		0,9		
	NEW 1.8	Z 18 XE	92/125	03.2004	10.2010	RFN 42 LZG	A532		0,9		
	NEW 1.8	A 18 XER / Z 18 XER	103/140	01.2006	10.2010	RFN 42 LZG	A532		0,9		
	2.0 Turbo	Z 20 LEL	125/170	03.2004		RFC 52 LZ2E	A102		0,75		
	2.0 Turbo	Z 20 LER	147/200	09.2004		RFC 52 LZ2E	A102		0,75		
	2.0 Turbo	Z 20 LEH	177/241	03.2005		RFC 62 LSDP5	A507		1,1		

(f) Available until end of stock

(a) 30 000 km

(b) 60 000 km

(c) Grey sticker on ignition coil

(d) Green sticker on ignition coil

(e) Hex 21 mm

(f) Hex 16 mm

(g) Recommended for cold weather



EYQUEM



Box
10

Blister
4



F3→1

OPEL									
ASTRA H Break (L35)	NEW 1.4	Z 14 XEL	55/75	08.2004	10.2010	RFN 42 LZG	A532		0,9
	NEW 1.4	Z 14 XEP	66/90	08.2004	10.2010	RFN 42 LZG	A532		0,9
	NEW 1.6	Z 16 XEP	77/105	08.2004	10.2010	RFN 42 LZG	A532		0,9
	NEW 1.6	Z 16 XER	85/115	12.2006	05.2014	RFN 42 LZG	A532		0,9
	NEW 1.8	Z 18 XE	92/125	08.2004	10.2010	RFN 42 LZG	A532		0,9
	NEW 1.8	A 18 XER / Z 18 XER	103/140	08.2005	10.2010	RFN 42 LZG	A532		0,9
	2.0 Turbo	Z 20 LEL	125/170	03.2004		RFC 52 LZE	A102		0,75
	2.0 Turbo	Z 20 LER	147/200	09.2004		RFC 52 LZE	A102		0,75
ASTRA H GTC (L08)	NEW 1.2	Z 12 XEP	59/80	08.2005		RFN 42 LZG	A532		0,9
	NEW 1.4	Z 14 XEL	55/75	03.2005	10.2010	RFN 42 LZG	A532		0,9
	NEW 1.4	Z 14 XEP	66/90	03.2005	10.2010	RFN 42 LZG	A532		0,9
	NEW 1.6	Z 16 XEP / Z 16 XE1	77/105	03.2005	10.2010	RFN 42 LZG	A532		0,9
	NEW 1.6	Z 16 XER	85/116	12.2006	10.2010	RFN 42 LZG	A532		0,9
	NEW 1.8	Z 18 XE	92/125	03.2005	10.2010	RFN 42 LZG	A532		0,9
	NEW 1.8	Z 18 XER	103/140	01.2006	10.2010	RFN 42 LZG	A532		0,9
	2.0 Turbo	Z 20 LEL	125/170	03.2004		RFC 52 LZE	A102		0,75
	2.0 Turbo	Z 20 LER	147/200	09.2004		RFC 52 LZE	A102		0,75
	2.0 Turbo	Z 20 LEH	177/241	08.2005		RFC 62 LSDP5	A507		1.1
ASTRA H TwinTop (L67)	NEW 1.6	Z 16 XE1 / Z 16 XEP	77/105	09.2005	10.2010	RFN 42 LZG	A532		0,9
	NEW 1.6	Z 16 XER	85/115	12.2006	10.2010	RFN 42 LZG	A532		0,9
	NEW 1.8	Z 18 XE	92/125	09.2005	10.2010	RFN 42 LZG	A532		0,9
	NEW 1.8	A 18 XER / Z 18 XER	103/140	09.2005	10.2010	RFN 42 LZG	A532		0,9
	2.0 Turbo	Z 20 LEL	125/170	09.2005		RFC 52 LZE	A102		0,75
	2.0 Turbo	Z 20 LER	147/200	09.2005		RFC 52 LZE	A102		0,75
ASTRA J	NEW 1.4	A 14 XEL	64/87	12.2009		RFN 42 LZG	A532		0,9
	NEW 1.4	A 14 XER	74/101	12.2009		RFN 42 LZG	A532		0,9
	NEW 1.6	A 16 XER	85/115	12.2009		RFN 42 LZG	A532		0,9
ASTRA J A	NEW 1.4	A 14 XER	74/101	06.2012		RFN 42 LZG	A532		0,9
	NEW 1.6	A 16 XER	85/115	06.2012		RFN 42 LZG	A532		0,9
ASTRA J GTC	NEW 1.4	A 14 XER	74/101	10.2011		RFN 42 LZG	A532		0,9
	NEW 1.8	A 18 XER	103/140	10.2011		RFN 42 LZG	A532		0,9
		chassis->92999999, 95...,98...,9B...,9G..							
ASTRA J Sports Tourer	NEW 1.4	A 14 XER	74/101	10.2010		RFN 42 LZG	A532		0,9
	NEW 1.6	A 16 XER	85/115	10.2010		RFN 42 LZG	A532		0,9
BEDFORD - BLITZ	2.0 CF	20 N	56/76	08.1984	07.1987	RC 42 S	A69	B23	0,7 N43
BLITZ	1.9T			01.1967	01.1975	RC 62 S	A95		0,7
	2.1T			01.1967	01.1975	RC 62 S	A95		0,7
CALIBRA A (85_)	2.0 i 4x4, GT	C 20 NE [OHC]	85/115	06.1990	07.1995	RC 52 LS (e)	A9	B20	0,7 L65
	2.0 i 4x4, GT	C 20 NE [OHC]	85/115	08.1995	07.1997	RFC 42 LZ2E (f)	A5	B30	1,0 F54
	2.0 i 16V, 4x4	X 20 XEV	100/136	02.1994	07.1997	RFC 42 LZ2E	A5	B30	1,0 F54
	2.0 i 16V, 4x4	20 - C20 XE [DOHC]	110/150	06.1990	08.1992	RFC 58 LZ2E	A10	B31	0,9 F54
	2.0 i 16V, 4x4	20 - C20 XE [DOHC]	110/150	09.1992	02.1994	RFC 42 LZ2E	A5	B30	1,0 F54
	2.0 i Turbo 4x4	C 20 LET [DOHC]	150/204	03.1992	08.1995	RFC 58 LZ2E	A75		1,1 F54-5
	2.5 i V6	C 25 XE [DOHC]	125/170	04.1993	04.1997	RFC 42 LZ2E	A5	B30	1,0 F54
	2.5 i V6 24V	X 25 XE [DOHC]	125/170	04.1993	04.1997	RFC 42 LZ2E	A5	B30	1,0 F54
CAMPO (TF)	2.3, 4x4 (TFR16/TFS16)	4 ZD1	69/94	09.1991	08.1994	RC 62 LS	A6	B17	0,7 L65
	2.3, 4x4 (TFR16/TFS16)	4 ZD1 / 23 P	72/98	08.1994	09.1996	RC 62 LS	A6	B17	0,7 L65
COMBO	1.3 N	13 N	44/60	01.1986	12.1989	RC 62 LS	A6	B17	0,8 L65
	1.3 S	13 S	55/75	01.1986	08.1987	RC 62 LS	A6	B17	0,8 L65
	1.6	16 SV	60/82	09.1986	12.1991	RC 62 LS	A6	B17	0,8 L65
	1.6 i	C 16 NZ	55/75	08.1991	07.1994	RC 52 LS	A9	B20	0,7 L65
COMBO (71_)	1.2 i	X 12 SZ - C 12 NZ [OHC]	33/45	03.1994	10.2001	RC 52 LS	A9	B20	0,7 L65
	1.2 i	X 12 SZ - C 12 NZ [OHC]	33/45	03.1994	10.2001	RFC 42 LZ2E	A5	B30	1,0 F54
	1.4 i	C 14 NZ [OHC]	44/60	07.1994	10.2001	RC 52 LS (e)	A9	B20	0,7 L65
	1.4 i	C 14 NZ / X14 SZ	44/60	07.1994	10.2001	RFC 42 LZ2E (f)	A5	B30	1,0 F54
	1.4 i Si	C 14 SE [OHC]	60/82	07.1994	10.2001	RC 52 LS (e)	A9	B20	0,7 L65
	1.4 i Si	C 14 SE [OHC]	60/82	07.1994	10.2001	RFC 42 LZ2E (f)	A5	B30	1,0 F54
COMBO Tour	NEW 1.4	Z 14 XEP	66/90	10.2004		RFN 42 LZG	A532		0,9
	1.6	Z 16 SE	64/87	10.2001	08.2004	RFC 42 LZ2E (f)	A5	B30	1,0 F54
	1.6 16V	Z 16 YNG	69/94	06.2006		FN 58 LZDPR	A198		0,75

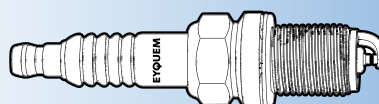

- (1) Available until end of stock
- (a) 30 000 km
- (b) 60 000 km
- (c) Grey sticker on ignition coil
- (d) Green sticker on ignition coil

- (e) Hex 21 mm
- (f) Hex 16 mm
- (g) Recommended for cold weather



Box
10

Blister
4



F3→1

OPEL

COMBO Tour (X12)	1.4	A 14 FP	70/95	02.2012		RZC 58 LS	A190		0,9	
COMBO	NEW 1.4	Z 14 XEP	66/90	08.2005		RFN 42 LZG	A532		0,9	
Camionnette/Break										
	1.6	Z 16 SE	64/87	10.2001	08.2004	RFC 42 LZ2E (f)	A5	B30	1,0	F54
COMBO Camionnette/ Break (X12)	1.4	A 14 FP	70/95	02.2012		RZC 58 LS	A190		0,9	
COMMODORE A	2.5 E, S	25 S	85/115	08.1967	08.1969	RC 42 S	A69	B23	0,7	N43
	2.5	25 SV	88/120	09.1969	01.1972	RC 42 S	A69	B23	0,7	N43
	2.5 i E, S	25 H	96/131	08.1967	01.1972	RC 42 S	A69	B23	0,7	N43
	2.5 GS/E	25 E	110/150	08.1969	01.1972	RC 42 S	A69	B23	0,7	N43
	2.8 GS	28 HL	107/146	05.1970	01.1971	RC 42 S	A69	B23	0,7	N43
COMMODORE B	2.5	25 S	85/115	01.1972	07.1978	RC 42 S	A69	B23	0,7	N43
	2.5 GS	25 H	96/131	01.1972	08.1975	RC 42 S	A69	B23	0,7	N43
	2.8 GS	28 HC	103/140	03.1975	07.1978	RC 42 S	A69	B23	0,7	N43
	2.8 GS	28 HC	104/141	01.1972	07.1978	RC 42 S	A69	B23	0,7	N43
	2.8 GS/E	28 HC	114/151	03.1975	07.1978	RC 42 S	A69	B23	0,7	N43
	2.8 GS/E	28 E / 28EC	118/160	07.1972	02.1975	RC 42 S	A69	B23	0,7	N43
COMMODORE C (14_, 19_)	2.5 S	25 S	85/115	08.1978	12.1982	RC 42 S	A69	B23	0,7	N43
	2.5 E	25 E	96/130	05.1981	12.1982	RC 42 S	A69	B23	0,7	N43
CORSA A (93_, 94_, 95_, 98_, 99_)	1.0 Calypso 2, City, Liberty, S, Steffi, Van, Viva	10 S [OHV]	33/45	09.1982	03.1993	RC 42 S	A69	B23	0,7	N43
	1.2	12 NC / E 12 GV [OHV]	33/45	09.1982	08.1990	RC 42 S	A69	B23	0,7	N43
	1.2 i Affaires, City, Joy, Steffi, Viva, Viva Plus	C 12 NZ [OHC]	33/45	09.1990	03.1993	RC 52 LS	A9	B20	0,7	L65
	1.2 GL, Liberty, Van, Viva	12 NV [OHC]	38/52	09.1986	03.1993	RC 62 LS	A6	B17	0,7	L65
	1.2 S	S 12 ST [OHC]	40/54	09.1984	03.1993	RC 62 LS	A6	B17	0,7	L65
	1.2 S	12 S	44/60	09.1982	08.1990	RC 62 LS	A6	B17	0,7	L65
	1.2 S	A 12 ST [OHC]	37-40/50-54	09.1986	03.1993	RC 62 LS	A6	B17	0,7	L65
	1.2 S, Calypso 2, GL, Steffi, Viva	12 S - 12 ST [OHC]	37-40/50-54	09.1982	03.1993	RC 62 LS	A6	B17	0,7	L65
	1.3	13 NB [OHC]	44/60	09.1985	10.1989	RC 62 LS	A6	B17	0,7	L65
	1.3 i	C 13 N [OHC]	44/60	09.1986	09.1990	RC 62 LS	A6	B17	0,7	L65
	1.3 Sprint R	13 E [OHC]	61/83	04.1985	03.1993	RC 62 LS	A6	B17	0,7	L65
	1.3 GL, GT, S, Viva	13 S - 13 SB [OHC]	51/70	09.1982	10.1989	RC 62 LS	A6	B17	0,7	L65
	1.4 i	C 14 NZ	44/60	01.1990	03.1993	RC 62 LS	A6	B17	0,7	L65
	1.4 GL, GT, Sprint, Viva	14 NV [OHC]	53/72	01.1990	03.1993	RC 52 LS (e)	A9	B20	0,7	L65
	1.4 GL, GT, Sprint, Viva	14 NV [OHC]	53/72	01.1990	03.1993	RFC 42 LZ2E (f)	A5	B30	1,0	F54
	1.4 GL, GT, Sprint, Viva	E 14 LV [OHC I]			03.1993	RC 62 LS	A6	B17	0,7	L65
	1.4 i	C 14 SE [OHC]	60/82	01.1991	03.1993	RC 52 LS (e)	A9	B20	0,7	L65
	1.4 i	C 14 SE [OHC]	60/82	01.1991	03.1993	RFC 42 LZ2E (f)	A5	B30	1,0	F54
	1.6 GSI	C 16 NZ - E 16 NZ [OHC]	55/75	04.1989	12.1989	RC 52 LS	A9	B20	0,7	L65
	1.6 GSI	C 16 NZ - E 16 NZ [OHC]	55/75	01.1990	09.1992	RFC 42 LZ2E (f)	A5	B30	1,0	F54
	1.6 GSI	C 16 SEI	72/98	09.1989	03.1993	RC 62 LS	A6	B17	0,7	L65
	1.6 GSI	C 16 SEI	72/98	09.1989	03.1993	RFC 42 LZ2E (f)	A5	B30	1,0	F54
	1.6 GSI	E 16 SE [OHC I]	74/101	05.1988	03.1993	RC 62 LS	A6	B17	0,7	L65
	1.6 GSI	C 16 SE [OHC]	74/101	05.1988	03.1993	RFC 42 LZ2E	A5	B30	1,0	F54
CORSA A Camionnette	1.0	10 S	33/45	02.1986	04.1989	RC 42 S	A69	B23	0,7	N43
	1.2	12 NC / E 12 GV	33/45	02.1986	04.1989	RC 42 S	A69	B23	0,7	N43
	1.2 S	12 ST	40/54	02.1986	04.1989	RC 62 LS	A6	B17	0,7	L65
	1.2	12 S	44/60	02.1986	07.1990	RC 62 LS	A6	B17	0,7	L65
	1.3	13 NB	44/60	02.1986	04.1989	RC 62 LS	A6	B17	0,7	L65
	1.3	13 SB	51/69	02.1986	04.1989	RC 62 LS	A6	B17	0,7	L65
CORSA A TR (91_, 92_, 96_, 97_)	1.0	10 S	33/45	09.1982	09.1992	RC 42 S	A69	B23	0,7	N43
	1.2 N	12 NC / E 12 GV [OHV]	33/45	01.1985	10.1987	RC 42 S	A69	B23	0,7	N43
	1.2 i	C 12 NZ	33/45	09.1990	03.1993	RC 52 LS	A9	B20	0,7	L65
	1.2 S	12 ST	40/55	09.1982	03.1993	RC 62 LS	A6	B17	0,7	L65
	1.2 S	12 S	43/58	09.1982	10.1987	RC 62 LS	A6	B17	0,7	L65
	1.3	13 NB / C 13 N	44/60	09.1985	10.1987	RC 62 LS	A6	B17	0,7	L65
	1.3 S	13 SB	51/70	09.1982	10.1987	RC 62 LS	A6	B17	0,7	L65
	1.4 i	C 14 NZ	44/60	10.1989	12.1989	RC 52 LS	A9	B20	0,7	L65
	1.4 i	C 14 NZ	44/60	01.1990	03.1993	RFC 42 LZ2E	A5	B30	1,0	F54
	1.4 S	14 NV	53/72	09.1989	03.1993	RC 52 LS	A9	B20	0,7	L65
	1.4 S	14 NV	53/72	09.1989	03.1993	RFC 42 LZ2E	A5	B30	1,0	F54

(f) Available until end of stock

(a) 30 000 km

(b) 60 000 km

(c) Grey sticker on ignition coil

(d) Green sticker on ignition coil

(e) Hex 21 mm

(f) Hex 16 mm

(g) Recommended for

cold weather

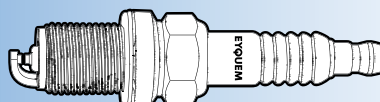

EYQUEM



Box
10

Blister
4



F3 → 1

OPEL										
CORSA B (73_, 78_, 79_) 1.0 i 12V	X 10 XE	40/54	11.1996	09.2000	RFC 42 LZ2E	A5	B30	1,0	F54	
1.2 i City	X 12 SZ - 12 NZ - C12 NZ [OHC]	33/45	03.1993	09.2000	RC 52 LS (e)	A9	B20	0,7	L65	
1.2 i City	X 12 SZ - 12 NZ - C12 NZ [OHC]	33/45	03.1993	09.2000	RFC 42 LZ2E (f)	A5	B30	1,0	F54	
1.2 i 16V	X 12 XE [DOHC]	48/65	09.1997	09.2000	RFC 42 LZ2E	A5	B30	1,0	F54	
1.4 i	X 14 SZ [OHC]	40-44/54-60	04.1996	09.2000	RFC 42 LZ2E	A5	B30	1,0	F54	
1.4 i	C 14 NZ [OHC]	44/60	01.1990	03.1996	RC 52 LS (e)	A9	B20	0,7	L65	
1.4 i	C 14 NZ [OHC]	44/60	01.1990	03.1996	RFC 42 LZ2E (f)	A5	B30	1,0	F54	
1.4 Si	C 14 SE	60/82	03.1993	09.2000	RC 52 LS (e)	A9	B20	0,7	L65	
1.4 Si	C 14 SE	60/82	03.1993	09.2000	RFC 42 LZ2E (f)	A5	B30	1,0	F54	
1.4 i 16V	C 14 SEL	63/86	08.1997	09.2000	RFC 42 LZ2E (f)	A5	B30	1,0	F54	
1.4 i 16V	X 14 XE	66-67/90-91	09.1994	09.2000	RFC 42 LZ2E	A5	B30	1,0	F54	
1.6 i 16V	X 16 XE [DOHC]	78/106	09.1994	09.2000	RFC 42 LZ2E	A5	B30	1,0	F54	
1.6 i	C 16 XE [DOHC]	80/109	03.1993	09.2000	RFC 42 LZ2E	A5	B30	1,0	F54	
CORSA B camionnette (73_) 1.4 i	C 14 NZ / X14 SZ	44/60	08.1999	09.2000	RFC 42 LZ2E	A5	B30	1,0	F54	
CORSA C (F08, F68) 1.0	Z 10 XE Ecotec [DOHC]	43/58	09.2000	06.2003	RFC 42 LZ2E	A5	B30	1,0	F54	
NEW 1.0	Z 10 XEP	44/60	06.2003	12.2009	RFN 42 LZG	A532		0,9		
1.2 i 16V	Z 12 XE Ecotec	55/75	09.2000	12.2009	RFC 42 LZ2E	A5	B30	1,0	F54	
NEW 1.2 Twinport	Z 12 XEP	59/80	07.2004	12.2009	RFN 42 LZG	A532		0,9		
NEW 1.4 Twinport	Z 14 XEP	66/90	06.2003	12.2009	RFN 42 LZG	A532		0,9		
1.4	Z 14 XE	66/90	09.2000	12.2009	RFC 42 LZ2E	A5	B30	1,0	F54	
GSI, Sport	Z 18 XE [DOHC]	92/125	09.2000	12.2009	RFC 42 LZ2E	A5	B30	1,0	F54	
CORSA C NEW 1.2 16V	Z 12 XE	55/75	09.2000		RFC 42 LZ2E	A5	B30	1,0	F54	
Camionnette (F08, W5L) NEW 1.2	Z 12 XEP	59/80	07.2005		RFN 42 LZG	A532		0,9		
NEW 1.4	Z 14 XEP	66/90	08.2003		RFN 42 LZG	A532		0,9		
CORSA D (S07) NEW 1.0	Z 10 XEP	44/60	07.2006		RFN 42 LZG	A532		0,9		
NEW 1.0	A 10 XEP	48/65	01.2010		RFN 42 LZG	A532		0,9		
NEW 1.2	A 12 XEL	51/69	06.2010		RFN 42 LZG	A532		0,9		
NEW 1.2	Z 12 XEP	59/80	07.2006		RFN 42 LZG	A532		0,9		
NEW 1.2	A 12 XER	63/86	06.2010		RFN 42 LZG	A532		0,9		
NEW 1.4	A 14 XEL	64/87	07.2006		RFN 42 LZG	A532		0,9		
NEW 1.4	Z 14 XEP	66/90	07.2006		RFN 42 LZG	A532		0,9		
1.4 LPG	Z 14 XEP	66/90	07.2006		RFC 58 LZ2E5	A75		0,7		
NEW 1.4	A 14 XEL	64/87	09.2009		RFN 42 LZG	A532		0,9		
NEW 1.4	A 14 XER	74/100	06.2010		RFN 42 LZG	A532		0,9		
CORSA D Van (S07) NEW 1.0	A 10 XEP	44/60	07.2006		RFN 42 LZG	A532		0,9		
NEW 1.0	A 10 XEP	48/65	01.2010		RFN 42 LZG	A532		0,9		
NEW 1.2	A 12 XEL	51/69	06.2010		RFN 42 LZG	A532		0,9		
NEW 1.2	Z 12 XEP	59/80	07.2009		RFN 42 LZG	A532		0,9		
NEW 1.2	A 12 XER	63/86	06.2010		RFN 42 LZG	A532		0,9		
CORSA E (X15) NEW 1.2	B 12 XEL	51/69	10.2014		RFN 42 LZG	A532		0,9		
NEW 1.4	B 14 XEJ	55/75	10.2014		RFN 42 LZG	A532		0,9		
NEW 1.4	B 14 XEL	66/90	10.2014		RFN 42 LZG	A532		0,9		
CORSA E Van (X15) NEW 1.2	B 12 XEL	51/69	01.2015		RFN 42 LZG	A532		0,9		
NEW 1.4	B 14 XEJ	55/75	10.2014		RFN 42 LZG	A532		0,9		
NEW 1.4	B 14 XEL	66/90	10.2014		RFN 42 LZG	A532		0,9		
DIPLOMAT B 2.8, E	28 H	103/140	03.1969	01.1978	RC 42 S	A69	B23	0,7	N43	
2.8 i, E	28 E	121/165	03.1969	02.1975	RC 42 S	A69	B23	0,7	N43	
FRONTERA A Sport (5_SUD2) 2.0 i	C 20 NE [OHC]	85/115	09.1991	08.1995	RC 52 LS (e)	A9	B20	0,7	L65	
2.0 i	X 20 SE [OHC]	85/115	02.1995	10.1998	RFC 42 LZ2E	A5	B30	1,0	F54	
2.0 i	C 20 NE [OHC]	85/115	03.1992	08.1995	RFC 42 LZ2E	A5	B30	1,0	F54	
FRONTERA (5_MWL4) 2.2 i	X 22 XE	100/136	03.1995	10.1998	RFC 42 LZ2E	A5	B30	1,0	F54	
2.4 i	C 24 NE	92/125	09.1991	02.1995	RC 42 S	A69	B23	0,7	N43	
FRONTERA B (6B) 2.2 i 16V	X 22 XE [DOHC]	100/136	10.1997		RFC 42 LZ2E	A5	B30	1,0	F54	
2.2 i	Y 22 SE	100/136	10.1998		RFN 58 LZDP5	A187		1,1		
3.2 i	Y 32 NE/6 VD1	151/205	10.1998		RFN 58 LZDP5	A187		1,1		
GT 1.1	11 SR	44/60	09.1968	12.1970	RC 42 S	A69	B23	0,7	N43	
1.9	19 S	66/90	09.1968	08.1973	RC 42 S	A69	B23	0,7	N43	



(1) Available until end of stock
 (a) 30 000 km
 (b) 60 000 km
 (c) Grey sticker on ignition coil
 (d) Green sticker on ignition coil

(e) Hex 21 mm
 (f) Hex 16 mm
 (g) Recommended for cold weather



Box
10

Blister
4



F3→1

OPEL

INSIGNIA A (G09)	NEW 1.6	A 16 XER	85/115	07.2008		RFN 42 LZG	A532	0,9		
	NEW 1.8	A 18 XER	103/140	07.2008		RFN 42 LZG	A532	0,9		
	2.8 V6 Turbo 4x4	A 28 NET	191/260	07.2008		RFC 58 HZEDP5	A191	1,05		
	2.8 V6 Turbo OPC 4x4	A 28 NER	239/325	07.2009		RFC 58 HZEDP5	A191	1,05		
INSIGNIA A A trois volume (G09)	NEW 1.6	A 16 XER	85/116	07.2008		RFN 42 LZG	A532	0,9		
	NEW 1.8	A 18 XER	103/140	07.2008		RFN 42 LZG	A532	0,9		
	2.8 V6 Turbo 4x4	A 28 NET	191/260	07.2008		RFC 58 HZEDP5	A191	1,05		
	2.8 V6 Turbo OPC 4x4	A 28 NER	239/325	07.2009		RFC 58 HZEDP5	A191	1,05		
INSIGNIA A Sport Tourer (G09)	NEW 1.6	A 16 XER	85/115	07.2008	06.2012	RFN 42 LZG	A532	0,9		
	NEW 1.8	A 18 XER	103/140	07.2008	06.2013	RFN 42 LZG	A532	0,9		
	2.8 V6 Turbo 4x4	A 28 NET	191/260	10.2008	06.2013	RFC 58 HZEDP5	A191	1,05		
	2.8 V6 Turbo OPC 4x4	A 28 NER	239/325	07.2009	06.2015	RFC 58 HZEDP5	A191	1,05		
KADETT B	1.1	11 N	33/45	09.1965	07.1971	RC 42 S	A69	B23	0,7 N43	
	1.1	11 N	37/50	07.1971	08.1973	RC 42 S	A69	B23	0,7 N43	
	1.1 S	11 S	40/55	09.1965	07.1971	RC 42 S	A69	B23	0,7 N43	
	1.1 SR	11 SR	44/60	11.1966	07.1971	RC 42 S	A69	B23	0,7 N43	
	1.2 S	12 S	44/60	08.1971	08.1973	RC 42 S	A69	B23	0,7 N43	
	1.7	17 S	55/75	08.1967	08.1971	RC 42 S	A69	B23	0,7 N43	
	KADETT B Break	1.1	11 N	33/45	09.1965	07.1971	RC 42 S	A69	B23	0,7 N43
KADETT B Break	1.1	11 N	37/50	08.1971	08.1973	RC 42 S	A69	B23	0,7 N43	
	1.1 S	11 S	40/55	09.1965	07.1971	RC 42 S	A69	B23	0,7 N43	
	1.2 S	12 S	44/60	08.1971	08.1973	RC 42 S	A69	B23	0,7 N43	
	KADETT B Coupé	1.1	11 N	33/45	09.1965	07.1971	RC 42 S	A69	B23	0,7 N43
		1.1	11 N	37/50	08.1971	08.1973	RC 42 S	A69	B23	0,7 N43
		1.1 S	11 S	40/55	09.1965	07.1971	RC 42 S	A69	B23	0,7 N43
		1.1 SR	11 SR	44/60	11.1966	07.1971	RC 42 S	A69	B23	0,7 N43
KADETT C - C Break	1.2	12 S	44/60	08.1971	08.1973	RC 42 S	A69	B23	0,7 N43	
	1.5	15 NT	47/64	08.1971	07.1973	C 32	A33		0,6	
	1.9	19 S	66/90	08.1967	08.1973	RC 42 S	A69	B23	0,7 N43	
	KADETT C - C Break	1.0	10 N	29/40	01.1974	07.1979	RC 42 S	A69	B23	0,7 N43
		1.2	12 N	38/52	08.1973	04.1977	RC 42 S	A69	B23	0,7 N43
		1.2	12 N	40/54	08.1973	07.1979	RC 42 S	A69	B23	0,7 N43
		1.2 S	12 S	44/60	08.1973	07.1979	RC 42 S	A69	B23	0,7 N43
KADETT C City	1.6 S	16 S	55/75	05.1977	07.1979	RC 42 S	A69	B23	0,7 N43	
	KADETT C City	1.0	10 N	29/40	05.1975	07.1979	RC 42 S	A69	B23	0,7 N43
		1.2	12 N	38/52	05.1975	04.1977	RC 42 S	A69	B23	0,7 N43
		1.2	12 N	40/54	07.1976	07.1979	RC 42 S	A69	B23	0,7 N43
		1.2 S	12 S	44/60	08.1973	07.1979	RC 42 S	A69	B23	0,7 N43
	KADETT C Coupé	1.6 S	16 S	55/75	05.1977	07.1979	RC 42 S	A69	B23	0,7 N43
		KADETT C Coupé	1.0	10 N	29/40	01.1974	07.1979	RC 42 S	A69	B23
1.2			12 N	38/52	08.1973	04.1977	RC 42 S	A69	B23	0,7 N43
1.2			12 N	40/54	08.1973	07.1979	RC 42 S	A69	B23	0,7 N43
1.2 S			12 S	44/60	08.1973	07.1979	RC 42 S	A69	B23	0,7 N43
KADETT D (31_34_41_44)		1.6 S	16 S	55/75	05.1977	07.1979	RC 42 S	A69	B23	0,7 N43
		1.9 GT/E	19 E	77/105	09.1975	07.1977	RC 42 S	A69	B23	0,7 N43
	2.0 E Rallye	20 E	81/110	08.1977	07.1979	RC 42 S	A69	B23	0,7 N43	
	2.0 GT/E	20 EH	85/115	08.1977	07.1979	RC 42 S	A69	B23	0,7 N43	
	KADETT D (31_34_41_44)	1.0	10 N	30/41	09.1979	07.1982	RC 42 S	A69	B23	0,7 N43
		1.2	12 N	39/53	08.1979	07.1982	RC 42 S	A69	B23	0,7 N43
		1.2	12 ST	40/55	08.1982	08.1984	RC 62 LS	A6	B17	0,7 L65
1.2		12 S	44/60	08.1979	08.1984	RC 42 S	A69	B23	0,7 N43	
KADETT D (32_37_39_42)	1.3 N	13 N	44/60	08.1979	08.1984	RC 62 LS	A6	B17	0,7 L65	
	1.3 S	13 S	55/75	08.1979	08.1984	RC 62 LS	A6	B17	0,7 L65	
	1.6 S	16 SH	66/90	09.1981	08.1984	RC 62 LS	A6	B17	0,7 L65	
	1.8 GT/E	18 E	85/115	02.1983	08.1984	RC 62 LS	A6	B17	0,7 L65	
	KADETT D (32_37_39_42)	1.0	10 N	30/41	09.1979	08.1982	RC 42 S	A69	B23	0,7 N43
		1.0	10 S	33/45	09.1979	08.1984	RC 42 S	A69	B23	0,7 N43
		1.2 S	12 S	44/60	08.1979	07.1982	RC 42 S	A69	B23	0,7 N43
1.3 N		C 13 N	44/60	08.1979	08.1984	RC 62 LS	A6	B17	0,7 L65	
1.3 S	13 S	55/75	08.1979	08.1984	RC 62 LS	A6	B17	0,7 L65		

- (f) Available until end of stock
 (a) 30 000 km
 (b) 60 000 km
 (c) Grey sticker on ignition coil
 (d) Green sticker on ignition coil

- (e) Hex 21 mm
 (f) Hex 16 mm
 (g) Recommended for cold weather

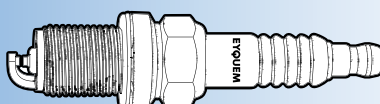

EYQUEM



Box
10

Blister
4



F3 → 1

OPEL										
KADETT D Break (35_36_45_46)	1.2	12 N	39/53	08.1979	07.1982	RC 42 S	A69	B23	0,7	N43
	1.2 S	12 S	44/60	08.1979	08.1984	RC 42 S	A69	B23	0,7	N43
	1.3 N	13 N	44/60	08.1979	08.1984	RC 62 LS	A6	B17	0,7	L65
	1.3 S	13 S	55/75	08.1979	08.1984	RC 62 LS	A6	B17	0,7	L65
	1.6 S	16 SH	66/90	09.1981	08.1984	RC 62 LS	A6	B17	0,7	L65
KADETT E (33_34_43_44)	1.2	12 SC	40/55	09.1984	07.1986	RC 42 S	A69	B23	0,7	N43
	1.3	13 N - 13 NB [OHC]	44/60	09.1984	08.1991	RC 62 LS	A6	B17	0,7	L65
	1.3 i Cat	C 13 N	44/60	09.1985	08.1991	RC 62 LS	A6	B17	0,7	L65
	1.3 S	13 S - 13 SC [OHC]	55/75	09.1984	08.1987	RC 62 LS	A6	B17	0,7	L65
	1.4 i	C 14 NZ	44/60	01.1990	08.1991	RC 52 LS (e)	A9	B20	0,7	L65
	1.4 i	C 14 NZ	44/60	01.1990	08.1991	RFC 42 LZ2E (f)	A5	B30	1,0	F54
	1.4 S	14 NV	55/75	01.1990	08.1991	RC 52 LS (e)	A9	B20	0,7	L65
	1.4 S	14 NV	55/75	01.1990	08.1991	RFC 42 LZ2E (f)	A5	B30	1,0	F54
	1.4 S	C 14 SE	60/82	09.1989	08.1991	RC 52 LS (e)	A9	B20	0,7	L65
	1.4 S	C 14 SE	60/82	09.1989	08.1991	RFC 42 LZ2E (f)	A5	B30	1,0	F54
	1.6 i	E 16 NZ	55/75	09.1986	08.1991	RC 52 LS (e)	A9	B20	0,7	L65
	1.6 i	E 16 NZ	55/75	09.1986	08.1991	RFC 42 LZ2E (f)	A5	B30	1,0	F54
	1.6 i	C 16 NZ [OHC]	55/75	09.1986	08.1991	RC 62 LS	A6	B17	0,7	L65
	1.6 i	C 16 LZ [OHC I]	55/75	09.1986	08.1991	RC 62 LS5	A24		1,1	L65-5
	1.6 S	16 SV	60/82	09.1986	08.1991	RC 62 LS	A6	B17	0,7	L65
	1.6 S	16 SH	66/90	09.1984	08.1986	RC 62 LS	A6	B17	0,7	L65
	1.8	E 18 NV / S 18 NV [OHC II]	62/84	09.1987	08.1991	RC 62 LS	A6	B17	0,7	L65
	1.8 i	C 18 NT	66/90	06.1985	08.1991	RC 62 LS	A6	B17	0,7	L65
	1.8 i	C 18 NZ [OHC II]	66/90	09.1990	08.1991	RC 52 LS (e)	A9	B20	0,7	L65
	1.8 i	C 18 NZ [OHC II]	66/90	09.1990	08.1991	RFC 42 LZ2E (f)	A5	B30	1,0	F54
	1.8 E	C 18 NE [OHC]	74/100	10.1985	08.1986	RC 62 LS	A6	B17	0,7	L65
	1.8 GSI	18 E	85/115	09.1984	08.1986	RC 62 LS	A6	B17	0,7	L65
	2.0 GSI	20 NE [OHC]	85/115	09.1986	08.1991	RC 52 LS (e)	A9	B20	0,7	L65
	2.0 GSI	20 NE [OHC]	85/115	09.1986	08.1991	RFC 42 LZ2E (f)	A5	B30	1,0	F54
	2.0 GSI	C 20 NE	85/115	09.1986	08.1991	RC 52 LS (e)	A9	B20	0,7	L65
	2.0 GSI	C 20 NE	85/115	09.1986	08.1991	RFC 42 LZ2E (f)	A5	B30	1,0	F54
	2.0 GSI	C 20 SEH	95/129	09.1986	08.1991	RC 62 LS	A6	B17	0,7	L65
	2.0 GSI 16V	20 XEJ	110/150	03.1988	08.1991	RFC 58 LZ2E	A10	B31	0,9	F54
	2.0 GSI 16V	C 20 XE	110/150	03.1988	08.1991	RFC 58 LZ2E	A10	B31	0,9	F54
	2.0 GSI 16V	20 XE	115/156	12.1987	08.1991	RFC 58 LZ2E	A10	B31	0,9	F54
KADETT E (39_49_)	1.2	12 SC	40/55	09.1984	07.1986	RC 42 S	A69	B23	0,7	N43
	1.3 N	13 N / 13 NB	44/60	09.1984	08.1989	RC 62 LS	A6	B17	0,7	L65
	1.3 i Cat	C 13 N	44/60	09.1985	08.1991	RC 62 LS	A6	B17	0,7	L65
	1.3 S	13 S	55/75	09.1984	08.1987	RC 62 LS	A6	B17	0,7	L65
	1.4 i	C 14 NZ	44/60	01.1990	08.1991	RC 52 LS (e)	A9	B20	0,7	L65
	1.4 i	C 14 NZ	44/60	01.1990	08.1991	RFC 42 LZ2E (f)	A5	B30	1,0	F54
	1.4 S	14 NV	55/75	01.1990	08.1991	RC 52 LS (e)	A9	B20	0,7	L65
	1.4 S	14 NV	55/75	01.1990	08.1991	RFC 42 LZ2E (f)	A5	B30	1,0	F54
	1.6 i	E 16 NZ	55/75	09.1986	08.1991	RC 62 LS	A6	B17	0,7	L65
	1.6 i Cat	C 16 NZ [OHC]	55/75	09.1986	08.1991	RC 62 LS	A6	B17	0,7	L65
	1.6 i Cat	C 16 LZ [OHC I]	55/75	09.1986	08.1991	RC 62 LS5	A24		1,1	L65-5
	1.6 S	16 SV	60/82	09.1986	08.1991	RC 62 LS	A6	B17	0,7	L65
	1.6 S	16 SH	66/90	09.1984	08.1986	RC 62 LS	A6	B17	0,7	L65
	1.8 S	E 18 NV	62/84	09.1987	08.1991	RC 62 LS	A6	B17	0,7	L65
	1.8 i	C 18 NZ [OHC II]	66/90	09.1990	08.1991	RC 52 LS (e)	A9	B20	0,7	L65
	1.8 i	C 18 NZ [OHC II]	66/90	09.1990	08.1991	RFC 42 LZ2E (f)	A5	B30	1,0	F54
	1.8 i	C 18 NE [OHC]	74/100	10.1985	08.1986	RC 62 LS	A6	B17	0,7	L65
	1.8	18 E	84/114	09.1987	08.1990	RC 62 LS	A6	B17	0,7	L65
	1.8 i	18 E / 18 SE	85/115	09.1984	08.1986	RC 62 LS	A6	B17	0,7	L65
	2.0 i	20 SE / 20 NE	85/115	03.1987	08.1991	RC 52 LS (e)	A9	B20	0,7	L65
	2.0 i	20 SE / 20 NE	85/115	03.1987	08.1991	RFC 42 LZ2E (f)	A5	B30	1,0	F54
	2.0 i Cat	C 20 NE	85/115	03.1987	08.1991	RC 52 LS (e)	A9	B20	0,7	L65
	2.0 i Cat	C 20 NE	85/115	03.1987	08.1991	RFC 42 LZ2E (f)	A5	B30	1,0	F54
KADETT E Break (35_36_45_46_)	1.2	12 SC	40/55	09.1984	07.1986	RC 42 S	A69	B23	0,7	N43
	1.3 N	13 N	44/60	09.1984	08.1991	RC 62 LS	A6	B17	0,7	L65
	1.3 i Cat	C 13 N	44/60	09.1985	08.1991	RC 62 LS	A6	B17	0,7	L65
	1.3 S	13 S	55/75	09.1984	08.1987	RC 62 LS	A6	B17	0,7	L65

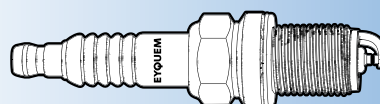

(1) Available until end of stock

- (a) 30 000 km
- (b) 60 000 km
- (c) Grey sticker on ignition coil
- (d) Green sticker on ignition coil

- (e) Hex 21 mm
- (f) Hex 16 mm
- (g) Recommended for cold weather



Box
10

Blister
4



F3-D1

OPEL

	1.4 i	C 14 NZ	44/60	01.1990	08.1991	RC 52 LS (e)	A9	B20	0,7	L65
	1.4 i	C 14 NZ	44/60	01.1990	08.1991	RFC 42 LZ2E (f)	A5	B30	1,0	F54
	1.4 S	14 NV	55/75	01.1990	08.1991	RC 52 LS (e)	A9	B20	0,7	L65
	1.4 S	14 NV	55/75	01.1990	08.1991	RFC 42 LZ2E (f)	A5	B30	1,0	F54
	1.6 i	E 16 NZ	55/75	09.1986	08.1991	RC 52 LS (e)	A9	B20	0,7	L65
	1.6 i	E 16 NZ	55/75	09.1986	08.1991	RFC 42 LZ2E (f)	A5	B30	1,0	F54
	1.6 i Cat	C 16 NZ [OHC]	55/75	09.1986	08.1991	RC 62 LS	A6	B17	0,7	L65
	1.6 i Cat	C 16 LZ [OHC I]	55/75	09.1986	08.1991	RC 62 LS5	A24		1,1	L65-5
	1.6 S	16 SV	60/82	09.1986	08.1991	RC 62 LS	A6	B17	0,7	L65
	1.6 S	16 SH	66/90	09.1984	08.1986	RC 62 LS	A6	B17	0,7	L65
	1.8 S	E 18 NV	62/84	09.1987	08.1991	RC 62 LS	A6	B17	0,7	L65
	1.8 i	C 18 NZ	66/90	10.1985	08.1991	RC 52 LS (e)	A9	B20	0,7	L65
	1.8 i	C 18 NZ	66/90	10.1985	08.1991	RFC 42 LZ2E (f)	A5	B30	1,0	F54
	1.8 E	C 18 NE	74/100	10.1985	09.1986	RC 62 LS	A6	B17	0,7	L65
	1.8	18 SE	82/112	12.1988	08.1991	RC 62 LS	A6	B17	0,7	L65
	1.8 i	18 E	85/115	09.1984	08.1986	RC 62 LS	A6	B17	0,7	L65
	2.0 i	20 NE	85/115	03.1987	08.1991	RC 52 LS (e)	A9	B20	0,7	L65
	2.0 i	20 NE	85/115	03.1987	08.1991	RFC 42 LZ2E (f)	A5	B30	1,0	F54
	2.0 i	C 20 NE	85/115	03.1987	08.1991	RC 52 LS (e)	A9	B20	0,7	L65
	2.0 i	C 20 NE	85/115	03.1987	08.1991	RFC 42 LZ2E (f)	A5	B30	1,0	F54
KADETT E Cabriolet (43B_)	1.3 S	13 S	55/75	03.1987	02.1993	RC 62 LS	A6	B17	0,7	L65
	1.4 i	C 14 NZ	44/60	01.1990	08.1991	RC 52 LS (e)	A9	B20	0,7	L65
	1.4 i	C 14 NZ	44/60	01.1990	08.1991	RFC 42 LZ2E (f)	A5	B30	1,0	F54
	1.4 S	14 NV	55/75	08.1990	02.1993	RC 52 LS (e)	A9	B20	0,7	L65
	1.4 S	14 NV	55/75	08.1990	02.1993	RFC 42 LZ2E (f)	A5	B30	1,0	F54
	1.6 i	E 16 NZ	55/75	10.1986	02.1993	RC 52 LS (e)	A9	B20	0,7	L65
	1.6 i	E 16 NZ	55/75	10.1986	02.1993	RFC 42 LZ2E (f)	A5	B30	1,0	F54
	1.6 i Cat	C 16 NZ [OHC]	55/75	10.1987	02.1993	RC 62 LS	A6	B17	0,7	L65
	1.6 i Cat	C 16 LZ [OHC I]	55/75	10.1987	02.1993	RC 62 LS5	A24		1,1	L65-5
	1.6 S	16 SV	60/82	07.1989	02.1993	RC 62 LS	A6	B17	0,7	L65
	2.0 i	C 20 NE	85/115	10.1986	02.1993	RC 52 LS (e)	A9	B20	0,7	L65
	2.0 i	C 20 NE	85/115	10.1986	02.1993	RFC 42 LZ2E (f)	A5	B30	1,0	F54
	2.0 i Cat	C 20 NE	85/115	10.1986	02.1993	RC 52 LS (e)	A9	B20	0,7	L65
	2.0 i Cat	C 20 NE	85/115	10.1986	02.1993	RFC 42 LZ2E (f)	A5	B30	1,0	F54
KADETT E Camionnette (37_47_)	1.2	12 SC	40/55	09.1984	07.1986	RC 42 S	A69	B23	0,7	N43
	1.3 N	13 N - 13 NB [OHC]	44/60	09.1984	07.1989	RC 62 LS	A6	B17	0,7	L65
	1.4 i	C 14 NZ	44/60	01.1990	08.1991	RC 52 LS (e)	A9	B20	0,7	L65
	1.4 i	C 14 NZ	44/60	01.1990	08.1991	RFC 42 LZ2E (f)	A5	B30	1,0	F54
	1.6 i	C 16 NZ	55/75	08.1989	09.1993	RC 62 LS	A6	B17	0,7	L65
	1.6 i	C 16 LZ	55/75	08.1989	09.1993	RC 62 LS5	A24		1,1	L65-5
	1.8 i	C 18 NT	66/90	08.1984	09.1992	RC 52 LS (e)	A9	B20	0,7	L65
	1.8 i	C 18 NT	66/90	08.1984	09.1992	RFC 42 LZ2E (f)	A5	B30	1,0	F54
KADETT E Camionnette (38_48_)	1.3 N	13 N	44/60	01.1986	12.1989	RC 62 LS	A6	B17	0,7	L65
	1.3 S	13 S	55/75	01.1986	12.1989	RC 62 LS	A6	B17	0,7	L65
	1.4 i	C 14 NZ	44/60	01.1991	07.1994	RC 52 LS (e)	A9	B20	0,7	L65
	1.4 i	C 14 NZ	44/60	01.1991	07.1994	RFC 42 LZ2E (f)	A5	B30	1,0	F54
	1.4 S	14 NV	55/75	07.1989	08.1991	RC 52 LS (e)	A9	B20	0,7	L65
	1.4 S	14 NV	55/75	07.1989	08.1991	RFC 42 LZ2E (f)	A5	B30	1,0	F54
	1.6 i	C 16 NZ	55/75	08.1991	07.1994	RC 52 LS (e)	A9	B20	0,7	L65
	1.6 i	C 16 NZ	55/75	08.1991	07.1994	RFC 42 LZ2E (f)	A5	B30	1,0	F54
	1.6	16 SV	60/82	09.1986	12.1991	RC 62 LS	A6	B17	0,7	L65
	1.6	16 SH	66/90	09.1986	06.1993	RC 62 LS	A6	B17	0,7	L65
MANTA	1.2 S	12 N - S	41-44/55-60	04.1972	02.1979	RC 42 S	A69	B23	0,7	N43
	1.3 S	13 N - S [OHC]	44-55/60-75	03.1979	08.1986	RC 62 LS	A6	B17	0,7	L65
	1.6 S	16 N [OHC]	44/60	09.1975	12.1980	RC 42 S	A69	B23	0,7	N43
	1.6 S	16 S [OHC]	55/75	09.1975	12.1980	RC 62 LS	A6	B17	0,7	L65
	1.8 S	18 S [OHC]	66/90	07.1982	08.1987	RC 62 LS	A6	B17	0,7	L65
	1.9 GT, GTe	19 N - S - E	55-77/75-105	09.1970	12.1980	RC 42 S	A69	B23	0,7	N43
	2.0 i S, E, GTE, GSi	20 E	77-81/105-110	08.1977	08.1988	RC 42 S	A69	B23	0,7	N43
	2.0 S	20 N - S	66-74/90-100	08.1977	08.1988	RC 42 S	A69	B23	0,7	N43
	400 : 2.4 ie	24 E	106/144	05.1982	07.1989	C 72 LJS	A22		0,7	J87
MERIVA A (X03) NEW	1.4 16v Twinport	Z 14 XEP	66/90	07.2004	05.2010	RFN 42 LZG	A532		0,9	

(f) Available until end of stock

(a) 30 000 km

(b) 60 000 km

(c) Grey sticker on ignition coil

(d) Green sticker on ignition coil

(e) Hex 21 mm

(f) Hex 16 mm

(g) Recommended for cold weather



EYQUEM



Box 10
Blister 4



F3 → 1

OPEL											
	NEW	1.4 16v Twinport LPG	Z 14 XEP	66/90	07.2004	05.2010	RFN 42 LZG	A532		0,9	
		1.6	Z 16 SE	64/87	05.2003	05.2010	RFC 42 LZ2E	A5	B30	1,0	F54
	NEW	1.6	Z 16 XEP	77/105	01.2006	05.2010	RFN 42 LZG	A532		0,9	
		1.6 i 16V	Z 16 XE - Z 16 SE [DOHC] Cat	74/101	05.2003	01.2006	RFC 42 LZ2E	A5	B30	1,0	F54
		1.8 i 16V	Z 18 XE [DOHC]	92/125	05.2003	05.2010	RFC 42 LZ2E	A5	B30	1,0	F54
MERIVA B (S10)	NEW	1.4	A 14 XER / B 14 XER	74/101	06.2010		RFN 42 LZG	A532		0,9	
MIDI		2.0 i	Cat	61/83	02.1986		RC 62 LS	A6	B17	0,8	L65
MOKKA / MOKKA X (J13)	NEW	1.6	A 16 XER	85/116	06.2012		RFN 42 LZG	A532			
MONTEREY		3.2 i V6 24V	6 VD 1	130/177	04.1992	12.1997	RFC 58 LS5	A38	B48	1,1	F54-5
MONTEREY B		3.5 V6 24V	6 VE1	158/215	07.1998	08.1999	FN 42 LZDPR5	A195		1,05	
MONZA A (22_)		2.0 i	20 E	81/110	03.1983	10.1984	RC 42 S	A69	B23	0,7	N43
		2.2 i	22 E	85/115	11.1984	08.1986	RC 42 S	A69	B23	0,7	N43
		2.5 i	H 25 E	100/136	05.1981	08.1986	RC 42 S	A69	B23	0,7	N43
		2.5 E	25 E	103/140	06.1984	08.1986	RC 42 S	A69	B23	0,7	N43
		2.8	28 H	103/140	02.1978	04.1981	RC 42 S	A69	B23	0,7	N43
		3.0	30 S	110/150	04.1978	07.1982	RC 42 S	A69	B23	0,7	N43
		3.0 GSE	C 30 LE	115/156	09.1985	08.1986	RC 42 S	A69	B23	0,7	N43
		3.0 GSE	30 E	132/180	02.1978	08.1986	RC 42 S	A69	B23	0,7	N43
OLYMPIA A		1.0	11 SR	44/60	08.1967	08.1971	C 62 S	A55		0,7	
		1.7	17 S	55/75	08.1967	08.1971	C 62 S	A55		0,7	
OMEGA		1.8	S 18 NV - E 18 NVR [OHC II]	60-65/82-88	09.1986	03.1994	RC 62 LS	A6	B17	0,7	L65
		1.8 i GL, LS	18 SEH [OHC II]	85/115	09.1986	03.1994	RC 62 LS	A6	B17	0,7	L65
		1.8 LS, S	18 SV [OHC, OHC II]	66/90	09.1986	03.1994	RC 62 LS	A6	B17	0,7	L65
		2.0 i	X 20 SE [OHC]	85/115	01.1994		RFC 42 LZ2E	A5	B30	1,0	F54
		2.0 i 16V CD, GL	X 20 XEV [DOHC]	100/136	01.1994		RFC 42 LZ2E	A5	B30	1,0	F54
		2.0 i CD, Century, GL, GLT	C 20 NE - 20 NE [OHC]	74-85/100-115	09.1986	03.1994	RC 52 LS	A9	B20	0,8	L65
		2.0 i CD, GL, GLS, Riviera	20 SE [OHC]	90/122	09.1986	03.1994	RC 62 LS	A6	B17	0,7	L65
		2.4 i CD, GL, GLS	C 24 NE	92/125	09.1988	03.1994	RC 42 S	A69	B23	0,7	N43
		2.5 i V6 24V CD	X 25 XE [DOHC]	125/170	01.1994		RFC 42 LZ2E	A5	B30	1,0	F54
		2.6 i V6 CD, GLS	C 26 NE	110/150	09.1990	03.1994	RC 42 S	A69	B23	0,7	N43
		2.6 V6, Caravan	Y 26 SE	132/180	09.2000	07.2003	RFC 42 LZ4E	A154		1,6	
		3.0 24V, Caravan	C 30 SE	150/204	09.1989	03.1994	RFC 58 LZK (a)	A11	B29	0,8	F54
		3.0 24V Evolution, Caravan	C 30 XEI	169/230	03.1991	07.1992	RFC 58 LZK (a)	A11	B29	0,8	F54
		3.0 24V, Caravan	C 30 SEJ	147/200	09.1989	03.1994	RFC 58 LZK (a)	A11	B29	0,8	F54
		3.0 i V6 24V	X 30 XE [DOHC]	155-169/211-230	01.1994		RFC 42 LZ2E	A5	B30	1,0	F54
		3.2 V6, Caravan	Y 32 SE	160/218	02.2001	07.2003	RFC 42 LZ4E	A154		1,6	
		3.6 Lotus	C 36 GET [DOHC]	265-281/360-382	09.1990	03.1994	FC 58 LS	A14		0,8	F54
		3000 : 3.0 24V	C 30 SEJ [DOHC]	147-150/200-204	09.1989	03.1994	RFC 58 LZ2E	A10	B31	0,9	F54
		3000 : 3.0 i 24V	C 30 SE [DOHC]	147-150/200-204	09.1989	03.1994	RFC 58 LZ2E	A10	B31	0,9	F54
		3000 : 3.0 i Sport, Caravan	C 30 NE	115-130/156-177	03.1987	03.1994	RC 42 S	A69	B23	0,7	N43
		3000 : 3.0 i V6 Sport, Caravan	C 30 LE	115-130/156-177	03.1987	03.1994	RC 42 S	A69	B23	0,7	N43
REKORD		1.7	17 L - 17 N	44-49/60-66	01.1972	08.1977	RC 42 S	A69	B23	0,7	N43
		1.7	17 S [OHC]	61/83	01.1972	02.1975	RC 62 LS	A6	B17	0,7	L65
		1.8 i	C 18 NV [OHC]	74/101	05.1985	08.1986	RC 62 LS	A6	B17	0,7	L65
		1.8 S	18N [OHC]	55/75	11.1982	08.1986	RC 62 LS	A6	B17	0,7	L65
		1.8 S	S 18 S [OHC]	59/80	03.1984	08.1986	RC 62 LS	A6	B17	0,7	L65
		1.9	19 N - SH	52-71/71-97	01.1972	08.1977	RC 42 S	A69	B23	0,7	N43
		2.0 i	20 E	81/110	09.1977	08.1986	RC 42 S	A69	B23	0,7	N43
		2.0 S	20 N - S	66-74/90-100	09.1977	08.1986	RC 42 S	A69	B23	0,7	N43
		2.2 i	22 E	85/115	11.1984	08.1986	RC 42 S	A69	B23	0,7	N43
SENATOR		2.0 i	20 E	81-85/110-115	03.1983	10.1984	RC 42 S	A69	B23	0,7	N43
		2.2 i	22 E	85/115	11.1984	08.1987	RC 42 S	A69	B23	0,7	N43
		2.5 i	25 E - 25 NE	100-103/136-140	05.1981	12.1989	RC 42 S	A69	B23	0,7	N43
		2.6 i V6	C 26 NE	110/150	09.1990	09.1993	RC 42 S	A69	B23	0,7	N43
		2.8	28 H	103/140	08.1979	04.1981	RC 42 S	A69	B23	0,7	N43
		3.0	30 S	110/150	08.1979	07.1982	RC 42 S	A69	B23	0,7	N43
		3.0 24V	C 30 SE	150/204	09.1989	09.1993	RFC 58 LZK (a)	A11	B29	0,8	F54
		3.0 i 24V CD	C 30 SE [DOHC]	150/204	09.1989	09.1993	RFC 58 LZ2E	A10	B31	0,9	F54
		3.0 i CD	30 NE - 30 E - C 30 NE	115-131/156-180	08.1979	09.1993	RC 42 S	A69	B23	0,7	N43
		3.0 i V6 CD	C 30 LE	115/156	08.1979	09.1993	RC 42 S	A69	B23	0,7	N43
		3.0 i V6 CD	S 30 E	132/180	01.1983	08.1987	RC 42 S	A69	B23	0,7	N43
		3.6 i	C 36 NE Irmscher	145-147/197-200	08.1989	09.1993	RFC 58 LZ2E	A10	B31	0,9	F54
		4.0 i	C 40 SE Irmscher	200/272	01.1991	09.1993	RFC 58 LZ2E	A10	B31	0,9	F54
SIGNUM (Z03)	NEW	1.8	Z 18 XER	103/140	09.2005	12.2008	RFN 42 LZG	A532		0,9	

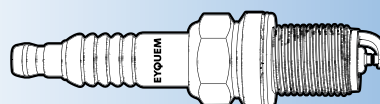

(1) Available until end of stock

- (a) 30 000 km
- (b) 60 000 km
- (c) Grey sticker on ignition coil
- (d) Green sticker on ignition coil

- (e) Hex 21 mm
- (f) Hex 16 mm
- (g) Recommended for cold weather



Box
10

Blister
4



F3-D1

OPEL

	1.8	Z 18 XE	90/122	05.2003		RFC 42 LZ4E	A154		1,6	
	1.8 LPG	Z 18 XE chassis n°->31999999	90/122	05.2003		RFC 52 LZ4E	A159		1,6	
	NEW 1.8	Z 18 XE Chassis n°41000001->	90/122	05.2003		RFN 42 LZG	A532		0,9	
	2.0 Turbo	Z 20 NET	129/175	05.2003	12.2008	RFC 62 LSDP5	A507		1,1	
	2.8 V6 Turbo	Z 28 NEL	169/230	09.2005	12.2008	RFC 58 HZEDP5	A191		1,1	
	2.8 V6 Turbo	Z 28 NET	184/250	01.2006	12.2008	RFC 58 HZEDP5	A191		1,1	
	3.2 V6	Z 32 SE	155/211	05.2003	07.2005	RFC 42 LZ4E	A154		1,6	
	3.2 V6 LPG	Z 32 SE	155/211	05.2003	07.2005	RFC 52 LZ4E	A159		1,6	
SINTRA	2.2 i 16V CD, GLS	X 22 XE [DOHC]	104/141	11.1996	04.1999	RFC 42 LZ2E	A5	B30	1,0	F54
	3.0 i V6 24V CD, GLS	X 30 XE [DOHC]	148/201	11.1996	04.1999	RFC 42 LZ2E	A5	B30	1,0	F54
SPEEDSTER	2.0 Turbo	Z 20 LET	147/200	04.2003		RFC 42 LZ2E	A5	B30	1,0	F54
	2.2 i 16V	Z 22 SE Ecotec	108/147	09.2000		RC 42 HJS3E5	A179		1,1	
TIGRA (75_)	1.4 i 16V	X 14 XE [DOHC]	66/90	07.1994	12.2000	RFC 42 LZ2E	A5	B30	1,0	F54
	1.6 i 16V	X 16 XE [DOHC]	78/106	07.1994	08.1998	RFC 42 LZ2E	A5	B30	1,0	F54
TIGRA TwinTop NEW	1.4	Z 14 XEP	66/90	06.2004		RFN 42 LZG	A532		0,9	
	1.8	Z 18 XE	92/125	06.2004	12.2009	RFC 42 LZ2E	A5	B30	1,0	F54
TRANS SPORT	2.3 i 16V	G 16V	101/137	01.1993		RFC 58 LS	A18		0,9	F54
	3.8 i V6	(L)	129/175	01.1993		RC 52 LJS5	A74	B56	1,3	
VECTRA A (86_, 87_)	1.4 S	14 NV	55/75	09.1988	06.1992	RC 52 LS (e)	A9	B20	0,7	L65
	1.6	C 16 LZ2	51/69	09.1992	07.1993	RFC 42 LZ2E	A5	B30	1,0	F54
	1.6 i	X 16 SZ [OHC]	52/71	09.1993	11.1995	RC 52 LS (e)	A9	B20	0,7	L65
	1.6 i	X 16 SZ [OHC]	52/71	09.1993	11.1995	RFC 42 LZ2E (f)	A5	B30	1,0	F54
	1.6 i	C 16 NZ/E 16 NZ/ C16 NZ2	55/75	09.1988	11.1995	RC 52 LS (e)	A9	B20	0,7	L65
	1.6 i	C 16 NZ/E 16 NZ/ C16 NZ2	55/75	09.1988	11.1995	RFC 42 LZ2E (f)	A5	B30	1,0	F54
	1.6 i	16 LZ2 - C 16 LZ2	55/75	09.1993	11.1995	RFC 42 LZ2E (f)	A5	B30	1,0	F54
	1.6	16 SV [OHC]	60/82	09.1988	05.1993	RC 62 LS	A6	B17	0,7	L65
	1.8 S, 4x4	E 18 NVR	65/88	09.1988	07.1989	RC 62 LS	A6	B17	0,7	L65
	1.8 S	18 SV	66/90	09.1989	10.1990	RC 62 LS	A6	B17	0,7	L65
	1.8 i Cat	C 18 NZ	66/90	03.1990	11.1995	RC 52 LS (e)	A9	B20	0,7	L65
	1.8 i Cat	C 18 NZ	66/90	03.1990	11.1995	RFC 42 LZ2E (f)	A5	B30	1,0	F54
	2.0	C 20 NEF	74/100	09.1988	09.1989	RC 62 LS	A6	B17	0,7	L65
	2.0 i	20 NE	85/115	09.1988	10.1990	RC 52 LS (e)	A9	B20	0,7	L65
	2.0 i	20 NE	85/115	09.1988	10.1990	RFC 42 LZ2E (f)	A5	B30	1,0	F54
	2.0 i Cat, 4x4	C 20 NE	85/115	09.1988	11.1995	RC 52 LS (e)	A9	B20	0,7	L65
	2.0 i Cat, 4x4	C 20 NE	85/115	09.1988	11.1995	RFC 42 LZ2E (f)	A5	B30	1,0	F54
	2.0 i, 4x4	20 SEH [OHC II]	95/129	09.1988	09.1992	RC 62 LS	A6	B17	0,7	L65
	2.0 i 16V, 4x4	X 20 XEV	100/136	06.1994	11.1995	RFC 42 LZ2E (f)	A5	B30	1,0	F54
	2000 GT/ 16V, 4x4	20 XEJ	110/150	01.1989	06.1994	RFC 42 LZ2E (f)	A5	B30	1,0	F54
	2000 GT/ 16V Cat, 4x4	C 20 XE	110/150	02.1990	11.1995	RFC 42 LZ2E (f)	A5	B30	1,0	F54
	2.0 i Turbo 4x4	C 20 LET [DOHC]	150/204	06.1994	11.1995	RFC 58 LZ2E	A75		1,1	F54-5
	2.5 i V6 24V	C 25 XE [DOHC]	125/170	02.1993	11.1995	RFC 42 LZ2E	A5	B30	1,0	F54
VECTRA A (88_, 89_)	1.4 GL	14 NV [OHC]	55/75	09.1988	08.1995	RC 52 LS (e)	A9	B20	0,7	L65
	1.6	C 16 LZ2	51/69	09.1992	07.1993	RFC 42 LZ2E	A5	B30	1,0	F54
	1.6 i	X 16 SZ [OHC]	52/71	09.1993	11.1995	RC 52 LS (e)	A9	B20	0,7	L65
	1.6 i	X 16 SZ [OHC]	52/71	09.1993	11.1995	RFC 42 LZ2E (f)	A5	B30	1,0	F54
	1.6 i	16 LZ2 - X 16 SZR [OHC]	55/75	09.1993	11.1995	RFC 42 LZ2E	A5	B30	1,0	F54
	1.6 i Cat	C 16 NZ / C 16 NZ2	55/75	09.1988	11.1995	RC 52 LS (e)	A9	B20	0,7	L65
	1.6 i Cat	C 16 NZ / C 16 NZ2	55/75	09.1988	11.1995	RFC 42 LZ2E (f)	A5	B30	1,0	F54
	1.6 GL, GLS, S	16 SV [OHC]	60/82	09.1988	09.1992	RC 62 LS	A6	B17	0,7	L65
	1.8 S	E 18 NVR	65/88	09.1988	07.1989	RC 62 LS	A6	B17	0,7	L65
	1.8 i 4x4, S, S 4x4	18 SV - C 18 SV - E 18 NVR [OHC, OHC II]	65-66/88-90	09.1988	08.1995	RC 62 LS	A6	B17	0,7	L65
	1.8 i Cat	C 18 NZ	66/90	03.1990	11.1995	RC 52 LS (e)	A9	B20	0,7	L65
	1.8 i Cat	C 18 NZ	66/90	03.1990	11.1995	RFC 42 LZ2E (f)	A5	B30	1,0	F54
	2.0	C 20 NEF	74/100	04.1988	09.1989	RC 62 LS	A6	B17	0,7	L65
	2.0 i	20 NE	85/115	09.1988	10.1990	RC 52 LS (e)	A9	B20	0,7	L65
	2.0 i	20 NE	85/115	09.1988	10.1990	RFC 42 LZ2E (f)	A5	B30	1,0	F54
	2.0 i Cat	C 20 NE	85/115	09.1988	10.1995	RC 52 LS (e)	A9	B20	0,7	L65
	2.0 i Cat	C 20 NE	85/115	09.1988	10.1995	RFC 42 LZ2E (f)	A5	B30	1,0	F54
	2.0 i GT	20 SEH [OHC II]	95/129	09.1988	11.1995	RC 62 LS	A6	B17	0,7	L65
	2.0 i 16V	X 20 XEV	100/136	06.1994	11.1995	RFC 42 LZ2E (f)	A5	B30	1,0	F54
	2.0 i 16V	20 XEJ	110/150	02.1989	10.1990	RFC 42 LZ2E (f)	A5	B30	1,0	F54

(1) Available until end of stock

(a) 30 000 km

(b) 60 000 km

(c) Grey sticker on ignition coil

(d) Green sticker on ignition coil

(e) Hex 21 mm

(f) Hex 16 mm

(g) Recommended for cold weather

(g) Recommended for cold weather



EYQUEM



Box 10
Blister 4



F3

OPEL											
		2.0 i 16V Cat	C 20 XE	110/150	02.1990	08.1992	RFC 58 LZ2E	A10	B31	0,9	F54
		2.0 i 16V Cat	C 20 XE	110/150	09.1992	11.1995	RFC 42 LZ2E (f)	A5	B30	1,0	F54
		2.5 i V6 24V	C 25 XE [DOHC]	125/170	02.1993	11.1995	RFC 42 LZ2E	A5	B30	1,0	F54
VECTRA B (36_)		1.6 i	X 16 SZR	55/75	10.1995	04.2002	RFC 42 LZ2E	A5	B30	1,0	F54
		1.6 i 16V	Y 16 XE - Z 16 XE - X 16 XEL	74/101	10.1995	04.2002	RFC 42 LZ2E	A5	B30	1,0	F54
		1.8 i 16V	X 18 XE1 - Z 18 XEL	85/115	10.1995	09.2000	RFC 42 LZ2E	A5	B30	1,0	F54
		1.8 i 16V	X 18 XE	85/115	10.1995	09.2000	RFC 42 LZ2E	A5	B30	1,0	F54
		1.8 i 16V	Z 18 XE	92/125	09.2000	04.2002	RFC 42 LZ2E	A5	B30	1,0	F54
		2.0 i 16V	X 20 XEV - C 20 SEL	100/136	10.1995	09.2000	RFC 42 LZ2E	A5	B30	1,0	F54
		2.2 i 16V	Z 22 SE Ecotec	108/147	09.2000	04.2002	RC 42 HJS3E5	A179		1,1	
		2.5 i V6 24V	X 25 XE	125/170	10.1995	09.2000	RFC 42 LZ2E	A5	B30	1,0	F54
		2.6 i V6 24V	Y 26 SE	125/170	09.2000	04.2002	RFC 42 LZ4E	A154		1,6	
		2.6 i V6 24V	Y 26 SE	125/170	09.2000	04.2002	RFC 52 LZ4E	A159		1,6	
		i 500 2.5	X 25 XE	143/194	05.1998	09.2000	RFC 42 LZ2E	A5	B30	1,0	F54
VECTRA B (38_)		1.6 i	X 16 SZR	55/75	10.1995	07.2003	RFC 42 LZ2E	A5	B30	1,0	F54
		1.6 i 16V	Y 16 XE - Z 16 XE - X 16 XEL	74/101	10.1995	07.2002	RFC 42 LZ2E	A5	B30	1,0	F54
		1.8 i 16V	X 18 XE1 - Z 18 XEL	85/115	10.1995	09.2000	RFC 42 LZ2E	A5	B30	1,0	F54
		1.8 i 16V	X 18 XE	85/116	10.1995	09.2000	RFC 42 LZ2E	A5	B30	1,0	F54
		1.8 i 16V	Z 18 XE	92/125	09.2000	07.2003	RFC 42 LZ2E	A5	B30	1,0	F54
		2.0 i 16V	X 20 XEV - C 20 SEL	100/136	10.1995	09.2000	RFC 42 LZ2E	A5	B30	1,0	F54
		2.2 i 16V	Z 22 SE Ecotec	108/147	09.2000	07.2003	RC 42 HJS3E5	A179		1,1	
		2.5 i V6 24V	X 25 XE	125/170	10.1995	09.2000	RFC 42 LZ2E	A5	B30	1,0	F54
		2.6 i V6 24V	Y 26 SE	125/170	09.2000	07.2003	RFC 42 LZ4E	A154		1,6	
		2.6 i V6 24V LPG	Y 26 SE	125/170	09.2000	07.2003	RFC 52 LZ4E	A159		1,6	
VECTRA B Break (31_)		1.6 i	X 16 SZR	55/75	11.1996	06.2000	RFC 42 LZ2E	A5	B30	1,0	F54
		1.6 i 16V	Y 16 XE - Z 16 XE - X 16 XEL	74/101	11.1996	07.2002	RFC 42 LZ2E	A5	B30	1,0	F54
		1.8 i 16V	X 18 XE1 - Z 18 XEL	85/115	11.1996	09.2000	RFC 42 LZ2E	A5	B30	1,0	F54
		1.8 i 16V	X 18 XE	85/115	10.1995	09.2000	RFC 42 LZ2E	A5	B30	1,0	F54
		1.8 i 16V	Z 18 XE	92/125	09.2000	07.2003	RFC 42 LZ2E	A5	B30	1,0	F54
		2.0 i 16V	X 20 XEV - C 20 SEL	100/136	11.1996	09.2000	RFC 42 LZ2E	A5	B30	1,0	F54
		2.2 i 16V	Z 22 SE Ecotec	108/147	09.2000	07.2003	RC 42 HJS3E5	A179		1,1	
		2.5 i V6 24V	X 25 XE	125/170	11.1996	09.2000	RFC 42 LZ2E	A5	B30	1,0	F54
		2.6 i V6 24V	Y 26 SE	125/170	09.2000	07.2003	RFC 42 LZ4E	A154		1,6	
		2.6 i V6 24V LPG	Y 26 SE	125/170	09.2000	07.2003	RFC 52 LZ4E	A159		1,6	
		i 500 2.5	X 25 XE	143/194	05.1998	09.2000	RFC 42 LZ2E	A5	B30	1,0	F54
VECTRA C	NEW	1.6 16V	Z 16 XE	74/101	06.2004		RFN 42 LZG	A532		0,9	
	NEW	1.6 16V	Z 16 XEP	77/105	01.2006		RFN 42 LZG	A532		0,9	
	NEW	1.8 16V	Z 18 XEL	81/110	04.2002	08.2003	RFC 42 LZ4E	A154		1,6	
	NEW	1.8 16V LPG	Z 18 XEL	81/110	04.2002	08.2003	RFC 52 LZ4E	A159		1,6	
	NEW	1.8 16V	Z 18 XEL	81/110	09.2003		RFN 42 LZG	A532		0,9	
	NEW	1.8 16V	Z 18 XER	103/140	01.2006		RFN 42 LZG	A532		0,9	
	NEW	1.8 16V	Z 18 XE	90/122	04.2002	08.2003	RFC 42 LZ4E	A154		1,6	
	NEW	1.8 16V LPG	Z 18 XE	90/122	04.2002	08.2003	RFC 52 LZ4E	A159		1,6	
	NEW	1.8 16V	Z 18 XE	90/122	09.2003		RFN 42 LZG	A532		0,9	
		2.0 16V Turbo	Z 20 NET	129/175	03.2003		RFC 62 LSDP5	A507		1,1	
		2.2 i 16V	Z 22 SE Ecotec	108/147	04.2002		RC 42 HJS3E5	A179		1,1	
		2.8 V6 Turbo	Z 28 NEL	169/230	08.2005		RFC 58 HZEDP5	A191		1,1	
		2.8 V6 Turbo	Z 28 NET	184/250	08.2006		RFC 58 HZEDP5	A191		1,1	
		2.8 V6 Turbo	Z 28 NET	188/255	08.2005		RFC 58 HZEDP5	A191		1,1	
		2.8 V6 Turbo OPC	Z 28 NET	206/280	09.2006	09.2008	RFC 58 HZEDP5	A191		1,1	
		3.2 V6	Z 32 SE	155/211	08.2002		RFC 42 LZ4E	A154		1,6	
		3.2 V6 LPG	Z 32 SE	155/211	08.2002		RFC 52 LZ4E	A159		1,6	
VECTRA C Break	NEW	1.6 16V	Z 16 XE	74/101	06.2004		RFN 42 LZG	A532		0,9	
	NEW	1.6 16V	Z 16 XEP	77/105	01.2006		RFN 42 LZG	A532		0,9	
	NEW	1.8 16V	Z 18 XE	90/122	10.2003		RFN 42 LZG	A532		0,9	
	NEW	1.8 16V	Z 18 XER	103/140	01.2006		RFN 42 LZG	A532		0,9	
		2.0 Turbo	Z 20 NET	129/175	10.2003		RFC 62 LSDP5	A507		1,1	
		2.8 V6 Turbo	Z 28 NEL	169/230	08.2005		RFC 58 HZEDP5	A191		1,1	
		2.8 V6 Turbo	Z 28 NET	184/250	01.2007		RFC 58 HZEDP5	A191		1,1	
		2.8 V6 Turbo	Z 28 NET	188/255	08.2005		RFC 58 HZEDP5	A191		1,1	
		2.8 V6 Turbo	Z 28 NET	206/280	01.2007	10.2008	RFC 58 HZEDP5	A191		1,1	
		3.2 V6	Z 32 SE	155/211	10.2003		RFC 42 LZ4E	A154		1,6	
		3.2 V6 LPG	Z 32 SE	155/211	10.2003		RFC 52 LZ4E	A159		1,6	
VECTRA C GTS	NEW	1.6 16v	Z 16 XE	74/101	08.2005		RFN 42 LZG	A532		0,9	
	NEW	1.6 16v	Z 16 XEP	77/105	01.2006		RFN 42 LZG	A532		0,9	

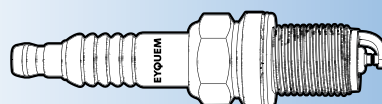

(1) Available until end of stock

- (a) 30 000 km
- (b) 60 000 km
- (c) Grey sticker on ignition coil
- (d) Green sticker on ignition coil

- (e) Hex 21 mm
- (f) Hex 16 mm
- (g) Recommended for cold weather



KW/HP



Box
10

Blister
4



F3-1

OPEL

	1.8 16v	Z 18 XEL	81/110	08.2002	08.2005	RFC 42 LZ2E	A5	B30	1,0	F54
	1.8 16v	Z 18 XE	90/122	08.2002	08.2003	RFC 42 LZ4E	A154		1,6	
	1.8 16v LPG	Z 18 XE	90/122	08.2002	08.2003	RFC 52 LZ4E	A159		1,6	
	NEW 1.8 16v	Z 18 XE	90/122	09.2003		RFN 42 LZG	A532		0,9	
	NEW 1.8 16v	Z 18 XER	103/140	01.2006		RFN 42 LZG	A532		0,9	
	2.0 16V Turbo	Z 20 NET	129/175	03.2003		RFC 62 LSDP5	A507		1,1	
	2.2 16V	Z 22 SE Ecotec	108/147	08.2002		RC 42 HJS3E5	A179		1,1	
	2.8 V6 Turbo	Z 28 NEL	169/230	08.2005		RFC 58 HZEDP5	A191		1,1	
	2.8 V6 Turbo	Z 28 NET	184/250	08.2006	10.2008	RFC 58 HZEDP5	A191		1,1	
	2.8 V6 Turbo	Z 28 NET	188/256	08.2005		RFC 58 HZEDP5	A191		1,1	
	2.8 V6 Turbo	Z 28 NET	206/280	08.2006		RFC 58 HZEDP5	A191		1,1	
	3.2 V6	Z 32 SE	155/211	08.2002		RFC 42 LZ4E	A154		1,6	
	3.2 V6 LPG	Z 32 SE	155/211	08.2002		RFC 52 LZ4E	A159		1,6	
VIVARO Combi (J7)	2.0 Ecotec	F4R 820	86/117	08.2006		RFN 58 LZDP	A519		0,9	
	2.0 16V	F4R 720	88/120	08.2001		RFN 58 LZDP	A519		0,9	
		chassis n°->6V699999, 6Y999999								
VIVARO Camionnette (F7)	2.0 Ecotec	F4R 820	86/117	08.2006		RFN 58 LZDP	A519		0,9	
	2.0 16V	F4R 720	88/120	08.2001		RFN 58 LZDP	A519		0,9	
		chassis n°->6V699999, 6Y999999								
VIVARO Camion Plate-forme (E7)	2.0 Ecotec	F4R 820	86/117	08.2006		RFN 58 LZDP	A519		0,9	
	2.0 16V	F4R 720	88/120	08.2003		RFN 58 LZDP	A519		0,9	
		chassis n°->6V699999, 6Y999999								
ZAFIRA A (F75_)	1.6 i 16V	Z 16 XE	74/101	04.1999		RFC 42 LZ2E	A5	B30	1,0	F54
	NEW 1.6 i 16V	Z 16 XE	74/101	04.1999		RFN 42 LZG	A532		0,9	
		engine n°->420 00000								
	1.6 i 16V Comfort, Elegance	X 16 XEL [DOHC]	74/101	03.1999		RFC 42 LZ2E	A5	B30	1,0	F54
	1.8 i 16V Elegance	X 18 XE1	85/115	04.1999	09.2000	RFC 42 LZ2E	A5	B30	1,0	F54
	1.8 i 16V	Z 18 XE [DOHC]	92/125	09.2000	06.2005	RFC 42 LZ2E	A5	B30	1,0	F54
	2.0 OPC	Z 20 LET	141/192	09.2001	06.2005	RFC 42 LZ2E	A5	B30	1,0	F54
	2.0 OPC	Z 20 LET	147/200	11.2002	01.2004	RFC 42 LZ2E	A5	B30	1,0	F54
	2.2 i 16V	Z 22 SE Ecotec	108/147	09.2000	06.2005	RC 42 HJS3E5	A179		1,1	
ZAFIRA B (A05)	NEW 1.6	Z 16 XE1 / Z 16 XEP	77/105	07.2005		RFN 42 LZG	A532		0,9	
	NEW 1.6	A 16 XER / Z 16 XER	85/115	01.2008		RFN 42 LZG	A532		0,9	
	NEW 1.8	A 18 XEL	88/120	06.2013	08.2015	RFN 42 LZG	A532		0,9	
	NEW 1.8	A 18 XER / Z 18 XER	103/140	07.2005		RFN 42 LZG	A532		0,9	
	2.0	Z 20 LEH	177/241	01.2006		RFC 62 LSDP5	A507		1,1	
ZAFIRA B Van (A05)	NEW 1.8	A 18 XER / Z 18 XER	103/140	07.2005		RFN 42 LZG	A532		0,9	
ZAFIRA TOURER C (P12)	NEW 1.8	A 18 XEL	85/115	10.2011		RFN 42 LZG	A532		0,9	
	NEW 1.8	A 18 XER	103/140	10.2011		RFN 42 LZG	A532		0,9	

OTOSAN

ANADOL	1300 : 1.3					C 52 LS	A1	B1	0,7	L65
	1600 : 1.6					C 52 LS	A1	B1	0,7	L65
TAUNUS	1.6	[OHC]		10.1988		RKC 62 JS	A29		0,8	
	1.6		52/71	01.1989		RKC 62 JS	A29		0,8	
	2.0		74/101	01.1989		RKC 62 JS	A29		0,8	
	2.0	[OHC]		10.1989		RKC 62 JS	A29		0,8	

PANTHER

DEVILLE	4.2					RC 32 LS	A49	B19	0,8	L3
	5.3 V12					RC 62 LS	A6	B17	0,8	L65
KALLISTA	1.6	[OHC]				RFC 58 LS	A18		0,8	F54
	2.8 i V6					RFC 62 LS	A48		0,8	F86
	2.8 V6					RFC 62 LS	A48		0,8	F86
	2.9 i V6					RFC 58 LS	A18		0,8	F54

(1) Available until end of stock

(a) 30 000 km

(b) 60 000 km

(c) Grey sticker on ignition coil

(d) Green sticker on ignition coil

(e) Hex 21 mm

(f) Hex 16 mm

(g) Recommended for cold weather



EYQUEM



Box
10

Blister
4



F3

PANTHER

RIO SPECIAL	2.0	[OHC]				C 72 LJS	A22		0,8	J87
SOLO	1.6	[OHC]				RFC 62 LS	A48		0,8	F86

PEUGEOT

104	0.9	108 (XV3)	34/46	10.1972	10.1979	C 62 LJS	A19	B2	0,6	J65
	0.9	108 (XV5)	33/45	10.1979	10.1983	C 62 LJS	A19	B2	0,6	J65
	1.0 GL, GR, Z, ZA, ZL	108C (XV8)	32/44	09.1983	06.1988	C 62 LJS	A19	B2	0,6	J65
	1.1	109F (XW7)	37/50	08.1980	06.1988	C 62 LJS	A19	B2	0,6	J65
	1.1	109 (XW3)	42/57	07.1976	08.1982	C 62 LJS	A19	B2	0,6	J65
	1.1	XW3S	48/65	09.1978	09.1979	C 62 LJS	A19	B2	0,6	J65
	1.2 SR	XZ5	42/57	08.1979	06.1983	C 62 LJS	A19	B2	0,6	J65
	1.4 S	150D (XY7)	44/60		05.1988	C 62 LJS	A19	B2	0,6	J65
	1.4 S	150 (XY6B)	53/72	08.1979	06.1988	C 62 LJS	A19	B2	0,6	J65
	1.4 ZS	XY8		07.1982	06.1986	C 72 LJS	A22		0,6	J87
1.4 ZS2	XZR			06.1988	C 82 LJS	A52		0,6	J87	
104 Coupe	0.9	108 (XV3, XV5)	33/45	09.1973	10.1983	C 62 LJS	A19	B2	0,6	J65
	1.1	121 (XW3S)	49/67	08.1975	06.1980	C 62 LJS	A19	B2	0,6	J65
	1.1	109F (XW7)	37/50	08.1979	06.1988	C 62 LJS	A19	B2	0,6	J65
	1.1	109 (XW3)	42/57	08.1979	06.1983	C 62 LJS	A19	B2	0,6	J65
	1.1	XW3S	48/65	09.1973	09.1979	C 62 LJS	A19	B2	0,6	J65
	1.4	150 (XY6B)	53/72	08.1979	06.1984	C 62 LJS	A19	B2	0,6	J65
106 I	1.0	TU9 [C1A] [C1B]	32/44	09.1991	04.1996	RFC 58 LZK (a)	A11	B29	0,9	F54
	1.0	CDY (TU9M)	33/45	09.1991	04.1996	RFC 42 LZ2E	A5	B30	0,9	F54
	1.0 i	CDZ (TU9M)	37/50	09.1991	04.1996	RFC 42 LZ2E	A5	B30	0,9	F54
	1.1	TU1 [H1A] [H3A]	40/54	09.1991		RFC 58 LZK (a)	A11	B29	0,9	F54
	1.1	HDZ (TU1M)	44/60	09.1991	04.1996	RFC 42 LZ2E	A5	B30	0,9	F54
	1.1 XA, XN, XR, XT, Green	TU1M	41/56	07.1995		RFC 42 LZ2E	A5	B30	0,9	F54
	1.1 i	TU1M+ [HDY] [HDZ]	40/54	04.1996		RFC 58 LZK (a)	A11	B29	0,9	F54
	1.1 i	TU1M+ [HDY] [HDZ]	40/54	04.1996		RFN 58 LZ (b)	A7	B28	0,9	F54
	1.1 i	TU1JP-L4 [HFZ]	44/60	05.2000		RFC 58 LZK (a)	A11	B29	0,9	F54
	1.1 i	TU1JP-L4 [HFZ]	44/60	05.2000		RFN 58 LZ (b)	A7	B28	0,9	F54
	1.1 i	TU1M+ [HDY] [HDZ]	40/54	04.1996		RFN 58 LZ3A (g)	A515		0,9	
	1.1 i	TU1JP-L4 [HFZ]	44/60	05.2000		RFN 58 LZ3A (g)	A515		0,9	
	1.3	TU2J2	72/98	10.1993	04.1996	RFC 62 LS3	A56		1,2	
	1.3 i Rallye	TU2J2 [MFZ]	74/101		04.1996	RFC 62 LS3	A56		1,2	
	1.4	TU3TR [K3A]		09.1991	04.1996	RFC 58 LZK (a)	A11	B29	0,9	F54
	1.4	TU3TR [K3A]		09.1991	04.1996	RFN 58 LZ (b)	A7	B28	0,9	F54
	1.4	K5A (TU3) K2D (TU3.2)	51/69	09.1991	03.1996	RFC 58 LZK (a)	A11	B29	0,9	F54
	1.4	K5A (TU3) K2D (TU3.2)	51/69	09.1991	03.1996	RFN 58 LZ (b)	A7	B28	0,9	F54
	1.4	K5A (TU3) K2D (TU3.2)	51/69	09.1991	03.1996	RFN 58 LZ3A (g)	A515		0,9	
	1.4	KDX (TU3MC)/KDY (TU3M)	55/75	09.1991	04.1996	RFN 52 LZ	A27		0,9	F54
1.4	KFZ (TU3J2/Z)	69/94	09.1991	04.1996	RFC 58 LS3	A16	B33	1,2		
1.4 i	TU3J2 [K6B] [KFZ]	69/94	09.1991	04.1996	RFC 58 LS3	A16	B33	1,2		
1.4 i	TU3M [KDX] [KDY]	55/75	07.1995	04.1996	RFC 58 LZK (a)	A11	B29	0,9	F54	
1.4 i	TU3M [KDX] [KDY]	55/75	07.1995	04.1996	RFN 58 LZ (b)	A7	B28	0,9	F54	
1.4 i	TU3M [KDX] [KDY]	55/75	07.1995	04.1996	RFN 58 LZ3A (g)	A515		0,9		
NEW 1.4 i	TU3JP [KFX]	55/75	04.1996		RFN 58 LZ (b)	A7	B28	0,9	F54	
1.6	NFZ (TU5JP)	65/88	06.1993	06.1995	RFC 58 LS3	A16	B33	1,2		
1.6	NFZ (TU5JP)	65/88	07.1995	04.1996	RFC 58 LZ 2	A54		1,0	F54	
1.6	NFY (TU5J2)	76/103	01.1994	06.1995	RFC 62 LS	A48		0,8	F86	
1.6	NFY (TU5J2)	76/103	07.1995	04.1996	RFC 58 LZ 2	A54		1,0	F54	
1.6 i Rallye, S16, XSi	TU5J2 [NFY-NFW]	77/105	01.1994	06.1995	RFC 62 LS	A48		0,8	F86	
1.6 i Rallye, S16, XSi	TU5J2 [NFY-NFW]	77/105	07.1995	04.1996	RFC 58 LZ 2	A54		1,0	F54	
106 I Van	1.0	CDY (TU9M)	33/45	09.1991	03.2001	RFC 42 LZ2E	A5	B30	0,9	F54
106 II	1.0 Accent, Bahia, Kid, Lee, Long beach	CDY (TU9M)	33/45	07.1995		RFC 42 LZ2E	A5	B30	0,9	F54
	1.0 i	CDZ (TU9M)	37/50	01.1997		RFC 42 LZ2E	A5	B30	0,9	F54
	1.1 i	HDZ (TU1M)/HFX (TU1JP)	44/60	05.1996		RFC 58 LZ 2	A54		1,0	F54
	1.1 i	HDY (TU1M)	40/54	01.1997		RFC 58 LZ 2	A54		1,0	F54
	1.4 i	KFW (TU3JP)/KFX (TU3JP)	55/75	05.1996		RFC 58 LZ 2	A54		1,0	F54
	1.6 i	NFZ (TU5JP)	65/88	05.1996		RFC 58 LS3	A16	B33	1,2	
	1.6 i	NFW (TU5J2)/NFY (TU5J2)	74/101	05.1996		RFC 58 LZ 2	A54		1,0	F54
	1.6 i 16V GTi, S16	NFX (TU5J4)	87/118	05.1996		RFC 58 LZ 2	A54		1,0	F54
107	NEW 1.0 i 12v	1KR, CFA (384F)	50/68	06.2005		RFN 58 HZ5	A534		1.15	
108	NEW 1.0 VTI 68	1KR-FE (E80)	51/69	05.2014		RZN 32 HSWDP	A531		1.0	
	NEW 1.2	HMT (E82D)	60/82	05.2014		RZN 32 HSWDP	A531		1.0	

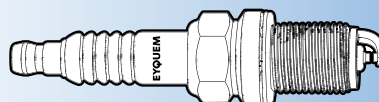

(1) Available until end of stock

- (a) 30 000 km
- (b) 60 000 km
- (c) Grey sticker on ignition coil
- (d) Green sticker on ignition coil

- (e) Hex 21 mm
- (f) Hex 16 mm
- (g) Recommended for cold weather



KW/HP



Box
10

Blister
4



F3→1

PEUGEOT

204	1.1	XK	39/53	10.1965	07.1969	C 82 LS	A40	B6	0,6	L87	
	1.1	XK4	40/54	07.1969	07.1975	C 82 LS	A40	B6	0,6	L87	
	1.1	XK5	43/58	09.1975	07.1977	C 62 LJS	A19	B2	0,6	J65	
204 cabriolet	1.1	XK	39/53	01.1967	05.1969	C 82 LS	A40	B6	0,6	L87	
	1.1	XK4	40/54	05.1969	10.1970	C 82 LS	A40	B6	0,6	L87	
204 Coupe	1.1	XK4	40/54	05.1969	05.1970	C 82 LS	A40	B6	0,6	L87	
205 I	1.0	XV8 (108C)	33/45	02.1983	10.1990	C 62 LJS	A19	B2	0,6	J65	
	1.0	TU9	33/45	10.1987	06.1995	RFC 42 LS	A25		0,9	F54	
	1.1	109N (XW7)	36/49	02.1983	10.1987	C 62 LJS	A19	B2	0,6	J65	
	1.1	109F (XW7)	37/50	02.1983	10.1987	C 62 LJS	A19	B2	0,6	J65	
	1.3 Rallye	TU2.4	75/102	1988	07.1992	FC 82 LS 3	A84		1,05		
	1.4	150D, 150G (XY7)	44/60	02.1983	05.1988	C 62 LJS	A19	B2	0,6	J65	
	1.4	150 (XY6B)	53/72	02.1983	10.1990	C 62 LJS	A19	B2	0,6	J65	
	1.4	150H (XY8)	58/79	02.1983	12.1988	C 72 LJS	A22		0,6	J87	
	1.4	150B (XY8)	59/80	02.1983	12.1988	C 72 LJS	A22		0,6	J87	
	1.4	XY7CP [KAZ]	41/56	02.1983	10.1990	C 52 LJS	A23		0,6	J65	
	1.6	B1E (XU51C)	53/72	02.1983	06.1987	C 62 LJS	A19	B2	0,6	J65	
	1.6	B1A (XU51C)	53-55-58/72-75-79	02.1983	06.1987	C 62 LJS	A19	B2	0,6	J65	
	1.6	BAZ (XU5CP)	53-55/72-75	02.1983	06.1987	C 62 LJS	A19	B2	0,6	J65	
	1.6 i CTI, GTI	180A (XU5J)	76/103	02.1983	10.1987	C 72 LJS	A22		0,6	J87	
	1.6 GTI	XU5JA	84/114	02.1983	06.1987	C 72 LJS	A22		0,6	J87	
1.6 i GTi	XU5J [180A]	77/105	02.1983	06.1987	C 72 LJS	A22		0,6	J87		
1.9 GTI	DFZ (XU9J1)	75/102	03.1987	10.1987	C 62 LJS	A19	B2	0,6	J65		
1.9 GTI	D6B (XU9JA (ohne KAT))	94/128	10.1986	10.1987	RFN 58 LZ (b)	A7	B28	0,9	F54		
1.9 GTI	D6B (XU9JA (ohne KAT))	94/128	10.1986	10.1987	RFN 58 LZ3A (g)	A515		0,9			
205 I Cabriolet (741B, 20D)	1.1 CJ	HDZ (TU1M)	44/60	10.1989	12.1994	RFC 42 LS	A25		0,8	F54	
	1.4 CJ	150D, 150G (XY7)	44/60	03.1988	05.1989	C 62 LJS	A19	B2	0,6	J65	
	1.4 CJ	K1D (TU3)	49/67	03.1989	12.1994	RFC 58 LZK (a)	A11	B29	0,9	F54	
	1.4 CJ	K1D (TU3)	49/67	03.1989	12.1994	RFN 58 LZ (b)	A7	B28	0,9	F54	
	1.4 CJ	K1D (TU3)	49/67	03.1989	12.1994	RFN 58 LZ3A (g)	A515		0,9		
	1.4 CJ		50/68	08.1987	07.1990	RFC 58 LZK (a)	A11	B29	0,9	F54	
	1.4 CJ		50/68	08.1987	07.1990	RFN 58 LZ (b)	A7	B28	0,9	F54	
	1.4 CJ		50/68	08.1987	07.1990	RFN 58 LZ3A (g)	A515		0,9		
	1.4 CT	150H, 150B (XY8)	58/79	04.1986	12.1988	C 72 LJS	A22		0,6	J87	
	1.4	K2B (TU3S)	62/84	08.1987	06.1994	RFC 58 LZK (a)	A11	B29	0,9	F54	
	1.4	K2B (TU3S)	62/84	08.1987	06.1994	RFN 58 LZ (b)	A7	B28	0,9	F54	
	1.4	K2B (TU3S)	62/84	08.1987	06.1994	RFN 58 LZ3A (g)	A515		0,9		
	1.4 CJ KAT	KAY (TU3CP)	44/60	01.1989	09.1993	RFC 58 LZK (a)	A11	B29	0,9	F54	
	1.4 CJ KAT	KAY (TU3CP)	44/60	01.1989	09.1993	RFN 58 LZ (b)	A7	B28	0,9	F54	
	1.4 CJ KAT	KAY (TU3CP)	44/60	01.1989	09.1993	RFN 58 LZ3A (g)	A515		0,9		
	1.4 CJ	KDZ, KDY (TU3M)	55/75	05.1991	12.1994	RFC 58 LZK (a)	A11	B29	0,9	F54	
	1.4 CJ	KDZ, KDY (TU3M)	55/75	05.1991	12.1994	RFN 58 LZ (b)	A7	B28	0,9	F54	
	1.4 CJ	KDZ, KDY (TU3M)	55/75	05.1991	12.1994	RFN 58 LZ3A (g)	A515		0,9		
	1.6 CJ	BDY (XU5M3Z)	65/88	08.1992	12.1994	RFC 58 LZK (a)	A11	B29	0,9	F54	
	1.6 CJ	BDY (XU5M3Z)	65/88	08.1992	12.1994	RFN 58 LZ (b)	A7	B28	0,9	F54	
	1.6 CJ	BDY (XU5M3Z)	65/88	08.1992	12.1994	RFN 58 LZ3A (g)	A515		0,9		
	1.6 CTI	180A, 180Z (XU5J)	76/103	04.1986	10.1990	RFN 58 LZ (b)	A7	B28	0,9	F54	
	1.6 CTI	180A, 180Z (XU5J)	76/103	04.1986	10.1990	RFN 58 LZ3A (g)	A515		0,9		
	1.6 CTI	B6D (XU5JA)	85/115	08.1987	07.1992	RFN 58 LZ (b)	A7	B28	0,9	F54	
	1.6 CTI	B6D (XU5JA)	85/115	08.1987	07.1992	RFN 58 LZ3A (g)	A515		0,9		
	1.9 CTi	DFZ (XU9J1)	74/101	08.1987	07.1990	RFN 58 LZ (b)	A7	B28	0,9	F54	
	1.9 CTi	DFZ (XU9J1)	74/101	08.1987	07.1990	RFN 58 LZ3A (g)	A515		0,9		
	1.9 CTi	DFZ (XU9J1)	75/102	10.1987	12.1994	RFN 58 LZ (b)	A7	B28	0,9	F54	
	1.9 CTi	DFZ (XU9J1)	75/102	10.1987	12.1994	RFN 58 LZ3A (g)	A515		0,9		
	1.9 CTi	DKZ (XU9JA)	92/125	08.1990	07.1992	RFN 58 LZ (b)	A7	B28	0,9	F54	
	1.9 CTi	DKZ (XU9JA)	92/125	08.1990	07.1992	RFN 58 LZ3A (g)	A515		0,9		
	205 II (20A/C)	1.0	TU9 (C1A,C1B)	32/44	10.1987	06.1995	RFC 58 LZK (a)	A11	B29	0,9	F54
		1.0 GE, Junior, Look, Summer	TU9M	33/45	07.1995	09.1998	RFC42 LZ2E	A5	B30	0,9	F54
1.0 i		TU9M [CDY] [CDZ]	37/50	07.1992		RFC 58 LZK (a)	A11	B29	0,9	F54	
1.0 i		TU9M [CDY] [CDZ]	37/50	07.1992		RFN 58 LZ (b)	A7	B28	0,9	F54	
1.0 i		TU9M [CDY] [CDZ]	37/50	07.1992		RFN 58 LZ3A (g)	A515		0,9		
1.1 XA		E1A	40/54	07.1987	10.1988	FC 52 LS	A2	B9	0,8	F54	
1.1		109N (XW7)	36-37/49-50	02.1983	10.1990	C 62 LJS	A19	B2	0,6	J65	
1.1	H1A, H1B, H1C (TU1)	40/54	10.1987	10.1990	RFC 58 LZK (a)	A11	B29	0,9	F54		

(1) Available until end of stock

(a) 30 000 km

(b) 60 000 km

(c) Grey sticker on ignition coil

(d) Green sticker on ignition coil

(e) Hex 21 mm

(f) Hex 16 mm

(g) Recommended for

cold weather

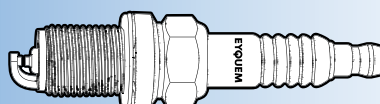

EYQUEM



Box
10

Blister
4



F3 → 1

PEUGEOT

1.1	H1A, H1B, H1C (TU1)	40/54	10.1987	10.1990	RFN 58 LZ (b)	A7	B28	0,9	F54	
1.1	H1A, H1B, H1C (TU1)	40/54	10.1987	10.1990	RFN 58 LZ3A (g)	A515		0,9		
1.1	HDZ (TU1M)	44/60	07.1989	06.1995	RFC 58 LZK (a)	A11	B29	0,9	F54	
1.1	HDZ (TU1M)	44/60	07.1989	06.1995	RFN 58 LZ (b)	A7	B28	0,9	F54	
1.1 Look, Sacré Numéro	HDZ (TU1M)	44/60	07.1995	09.1998	RFC42 LZ2E	A5	B30	0,9	F54	
1.2	F1	47/64	01.1987	12.1990	FC 52 LS	A2	B9	0,8	F54	
1.3	G1A (M104)	47/64	08.1990	07.1992	FC 52 LS	A2	B9	0,8	F54	
1.3 Rallye	TU24	74/101	10.1987	10.1990	FC 82 LS 3	A84		1,05		
1.4	150D, 150G (XY7)	44/60	10.1987	05.1989	C 62 LJS	A19	B2	0,6	J65	
1.4 KAT	KAY (TU3CP)	44/60	10.1987	05.1989	RFC 58 LZK (a)	A11	B29	0,9	F54	
1.4 KAT	KAY (TU3CP)	44/60	10.1987	05.1989	RFN 58 LZ (b)	A7	B28	0,9	F54	
1.4 KAT	KAY (TU3CP)	44/60	10.1987	05.1989	RFN 58 LZ3A (g)	A515		0,9		
1.4	Y2	61/83	10.1987		RFC 58 LZK (a)	A11	B29	0,9	F54	
1.4	F1	47/64	10.1987		RFC 58 LZK (a)	A11	B29	0,9	F54	
1.4	K1D (TU3A)	49/67	10.1987	10.1990	FC 52 LS	A2	B9	0,8	F54	
1.4	150 (XY6B)	53/72	01.1987	07.1988	C 62 LJS	A19	B2	0,6	J65	
1.4	KDX (TU3MC), KDY, KDZ (TU3M), TU32	55/75	08.1990	07.1998	RFC 58 LZ 2	A54		1,0	F54	
1.4	150H, 150B (XY8)	58/79	07.1988	05.1989	C 72 LJS	A22		0,6	J87	
1.4	K2B (TU3S)	62/84	06.1987	12.1989	RFC 58 LZK (a)	A11	B29	0,9	F54	
1.4	K2B (TU3S)	62/84	06.1987	12.1989	RFN 58 LZ (b)	A7	B28	0,9	F54	
1.4	K2B (TU3S)	62/84	06.1987	12.1989	RFN 58 LZ3A (g)	A515		0,9		
1.4 i	KDX (TU3JP), KDZ, KDY (TU3M)	55/75	07.1988	09.1998	RFC 58 LZK (a)	A11	B29	0,9	F54	
1.4 i	KDX (TU3JP), KDZ, KDY (TU3M)	55/75	07.1988	09.1998	RFN 58 LZ (b)	A7	B28	0,9	F54	
1.4 i	KDX (TU3JP), KDZ, KDY (TU3M)	55/75	07.1988	09.1998	RFN 58 LZ3A (g)	A515		0,9		
1.4 KAT	KAY (TU3CP)	44/60	01.1989	10.1990	RFC 52 LS	A3	B16	0,9	F54	
1.6	B1E (XU51C)	53/72	07.1987	10.1990	RFC 58 LZK (a)	A11	B29	0,9	F54	
1.6	B1E (XU51C)	53/72	07.1987	10.1990	RFN 58 LZ (b)	A7	B28	0,9	F54	
1.6	B1E (XU51C)	53/72	07.1987	10.1990	RFN 58 LZ3A (g)	A515		0,9		
1.6	B1A (XU51C), BAZ (XU5CP)	55/75	07.1987	09.1998	RFC 58 LZK (a)	A11	B29	0,9	F54	
1.6	B1A (XU51C), BAZ (XU5CP)	55/75	07.1987	09.1998	RFN 58 LZ (b)	A7	B28	0,9		
1.6	B1A (XU51C), BAZ (XU5CP)	55/75	07.1987	09.1998	RFN 58 LZ3A (g)	A515		0,9		
1.6 Automatic		58/79	10.1987	09.1998	RFC 58 LZK (a)	A11	B29	0,9	F54	
1.6 Automatic		58/79	10.1987	09.1998	RFN 58 LZ (b)	A7	B28	0,9		
1.6 Automatic		58/79	10.1987	09.1998	RFN 58 LZ3A (g)	A515		0,9		
1.6 Automatic	BDY (XU5M2Z), BDY (XU5M3Z)	65/88	05.1990	09.1998	RFN 52 LZ	A27		0,9	F54	
1.6	171 (XU5S)	66/90	08.1990	07.1992	RFC 58 LZK (a)	A11	B29	0,9	F54	
1.6	171 (XU5S)	66/90	08.1990	07.1992	RFN 58 LZ (b)	A7	B28	0,9		
1.6	171 (XU5S)	66/90	08.1990	07.1992	RFN 58 LZ3A (g)	A515		0,9		
1.6 GTI	180A, 180Z (XU5J)	76/103	10.1987	12.1989	RFN 58 LZ (b)	A7	B28	0,9	F54	
1.6 GTI	180A, 180Z (XU5J)	76/103	10.1987	12.1989	RFN 58 LZ3A (g)	A515		0,9		
1.6 GTI		85/115	10.1987	12.1989	RFN 58 LZ (b)	A7	B28	0,9	F54	
1.6 GTI		85/115	10.1987	12.1989	RFN 58 LZ3A (g)	A515		0,9		
1.6 GTX		69/94	01.1987	10.1991	RFN 58 LZ (b)	A7	B28	0,9	F54	
1.6 GTX		69/94	01.1987	10.1991	RFN 58 LZ3A (g)	A515		0,9		
1.9 GTI	D2A (XU92C)	75/102	10.1987	05.1989	RFN 52 LZ	A27		0,8	F54	
1.9 GTI KAT	DFZ (XU9J1)	75/102	10.1987	07.1994	RFN 58 LZ (b)	A7	B28	0,9	F54	
1.9 GTI KAT	DFZ (XU9J1)	75/102	10.1987	07.1994	RFN 58 LZ3A (g)	A515		0,9		
1.9 GTI	DKZ (XU9JAZ)	88/120	10.1987	10.1994	RFN 52 LZ	A27		0,9	F54	
1.9 GTI	D6B (XU9JA)	94/128	10.1987	09.1998	RFN 52 LZ	A27		0,9	F54	
205 Kasten	1.1	36/49	02.1983	07.1987	C 62 LJS	A19	B2	0,6	J65	
	1.1	H1B (TU1)	40/54	08.1987	07.1990	FC 42 LS	A15	B14	0,8	F54
	1.4		44/60	02.1983	07.1987	RFC 58 LZK (a)	A11	B29	0,9	F54
	1.4		44/60	02.1983	07.1987	RFN 58 LZ (b)	A7	B28	0,9	
206 (2A/C)	1.1 i	HFY, HFX, HFZ (TU1JP)	44/60	09.1998	07.2000	RFC 58 LZK (a)	A11	B29	0,9	F54
	1.1 i	HFY, HFX, HFZ (TU1JP)	44/60	09.1998	07.2000	RFN 58 LZ (b)	A7	B28	0,9	F54
	1.1 i	HFY, HFX, HFZ (TU1JP)	44/60	09.1998	07.2000	RFN 58 LZ3A (g)	A515		0,9	
	1.4 i	KFX, KFW (TU3JP) [KFW]	55/75	09.1998		RFC 58 LZK (a)	A11	B29	0,9	F54
	1.4 i	KFX, KFW (TU3JP) [KFW]	55/75	09.1998		RFN 58 LZ (b)	A7	B28	0,9	F54
	1.4 i	KFX, KFW (TU3JP) [KFW]	55/75	09.1998		RFN 58 LZ3A (g)	A515		0,9	
	1.4 i 16V	KFU (ET3J4)	65/88	10.2003		RWC 52 HSK	A197	B58	0,9	
	1.6 i	NFZ (TU5JP)	65/88	09.1998	12.2000	RFC 58 LZK (a)	A11	B29	0,9	F54
	1.6 i	NFZ (TU5JP)	65/88	09.1998	12.2000	RFN 58 LZ (b)	A7	B28	0,9	F54
	1.6 i	NFZ (TU5JP)	65/88	09.1998	12.2000	RFN 58 LZ3A (g)	A515		0,9	
	1.6 i Roland Garros, XS, XT, XT Premium	TU5JP-L3 [NFZ]	65/88	09.1998		RFC 58 LZK (a)	A11	B29	0,9	F54

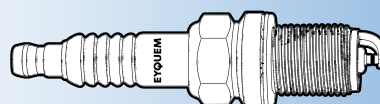

(1) Available until end of stock

- (a) 30 000 km
- (b) 60 000 km
- (c) Grey sticker on ignition coil
- (d) Green sticker on ignition coil

- (e) Hex 21 mm
- (f) Hex 16 mm
- (g) Recommended for cold weather



Box
10

Blister
4



F3-D1

PEUGEOT

	1.6 i Roland Garros, XS, XT, XT Premium TU5JP-L3 [NFZ]	65/88	09.1998		RFN 58 LZ (b)	A7	B28	0,9	F54	
	1.6 i Roland Garros, XS, XT, XT Premium TU5JP-L3 [NFZ]	65/88	09.1998		RFN 58 LZ3A (g)	A515		0,9		
	1.6 i 16V	NFU (TU5JP4-L4)	80/109	10.2000	RFN 58 HZ	A158		0,9		
	1.6 i 16V	NFU (TU5JP4-L4)	80/109	10.2000	RFN 58 HZ3A (g)	A516		0,9		
	2.0 S16	RFR (DEW10J4-L3)	99/135	05.1999	10.2000	RFN 52 HZ	A157	B50	0,9	
	2.0 S16	RFR (DEW10J4-L3)	99/135	05.1999	10.2000	RFN 52 HZ3A (g)	A100		0,9	
	2.0 i 16V	RFN (EW10J4-L4)	100/136	06.1999		RFN 52 HZ	A157	B50	0,9	
	2.0 i 16V	RFN (EW10J4-L4)	100/136	06.1999		RFN 52 HZ3A (g)	A100		0,9	
	2.0 16V S16	EW10J4L3	118/160	01.2001		RFN 52 HZ	A157	B50	0,9	
	2.0 16V S16	EW10J4L3	118/160	01.2001		RFN 52 HZ3A (g)	A100		0,9	
	2.0 RC	RFK (EW10J4S2)	130/177	07.2003		RFN 52 HZ	A157	B50	0,9	
	2.0 RC	RFK (EW10J4S2)	130/177	07.2003		RFN 52 HZ3A (g)	A100		0,9	
206 CC (2D)	1.6 16V	NFU (TU5JP4)	80/109	09.2000		RFN 58 HZ	A158		0,9	
	1.6 16V	NFU (TU5JP4)	80/109	09.2000		RFN 58 HZ3A (g)	A516		0,9	
	2.0 S16	RFN (EW10 J4-L4)	100/136	09.2000		RFN 52 HZ	A157	B50	0,9	
	2.0 S16	RFN (EW10 J4-L4)	100/136	09.2000		RFN 52 HZ3A (g)	A100		0,9	
206 Stufenheck	1.4	KFW (TU3JP), KFV (TU3A)	55/75	03.2007		RFC 58 LZK (a)	A11	B29	0,9	F54
	1.4	KFW (TU3JP), KFV (TU3A)	55/75	03.2007		RFN 58 LZ (b)	A7	B28	0,9	F54
	1.4	KFW (TU3JP), KFV (TU3A)	55/75	03.2007		RFN 58 LZ3A (g)	A515		0,9	
	1.6 16V	NFU (TU5JP4)	80/109	03.2007		RFN 58 HZ	A158		0,9	
	1.6 16V	NFU (TU5JP4)	80/109	03.2007		RFN 58 HZ3A (g)	A516		0,9	
206 SW (2E/K)	1.1	HFX (TU1JP)	44/60	07.2002		RFC 58 LZK (a)	A11	B29	0,9	F54
	1.1	HFX (TU1JP)	44/60	07.2002		RFN 58 LZ (b)	A7	B28	0,9	F54
	1.1	HFX (TU1JP)	44/60	07.2002		RFN 58 LZ3A (g)	A515		0,9	
	1.4	KFW (TU3JP), KFV (TU3A)	55/75	07.2002		RFC 58 LZK (a)	A11	B29	0,9	F54
	1.4	KFW (TU3JP), KFV (TU3A)	55/75	07.2002		RFN 58 LZ (b)	A7	B28	0,9	F54
	1.4	KFW (TU3JP), KFV (TU3A)	55/75	07.2002		RFN 58 LZ3A (g)	A515		0,9	
	1.4 16V	KFU (ET3J4)	65/88	10.2003		RWC 52 HSK	A197	B58	0,9	
	1.6 16V	NFU (TU5JP4)	80/109	07.2002		RFN 58 HZ	A158		0,9	
	1.6 16V	NFU (TU5JP4)	80/109	07.2002		RFN 58 HZ3A (g)	A516		0,9	
	2.0 16V	RFN (EW10J4)	100/136	07.2002		RFN 52 HZ	A157	B50	0,9	
	2.0 16V	RFN (EW10J4)	100/136	07.2002		RFN 52 HZ3A (g)	A100		0,9	
206+ (T3E)	1.1	HFX (TU1A-TU1JP)	44/60	01.2009		RFC 58 LZK (a)	A11	B29	0,9	F54
	1.1	HFX (TU1A-TU1JP)	44/60	01.2009		RFN 58 LZ (b)	A7	B28	0,9	F54
	1.1	HFX (TU1A-TU1JP)	44/60	01.2009		RFN 58 LZ3A (g)	A515		0,9	
	1.4i	KFT (TU3A)	54/73	09.2010		RFC 58 LZK (a)	A11	B29	0,9	F54
	1.4i	KFT (TU3A)	54/73	09.2010		RFN 58 LZ (b)	A7	B28	0,9	F54
	1.4i	KFT (TU3A)	54/73	09.2010		RFN 58 LZ3A (g)	A515		0,9	
	1.4i	KFV KFW (TU3A)	55/75	01.2009		RFC 58 LZK (a)	A11	B29	0,9	F54
	1.4i	KFV KFW (TU3A)	55/75	01.2009		RFN 58 LZ (b)	A7	B28	0,9	F54
	1.4i	KFV KFW (TU3A)	55/75	01.2009		RFN 58 LZ3A (g)	A515		0,9	
	1.6 16V	TU5JP4	80/109	07.2010		RFN 58 HZ	A158		0,9	
	1.6 16V	TU5JP4	80/109	07.2010		RFN 58 HZ3A (g)	A516		0,9	
207 (WA_, WC_)	1.4	KFV (TU3A)	53/72	02.2006		RFC 58 LZK (a)	A11	B29	0,9	F54
	1.4	KFV (TU3A)	53/72	02.2006		RFN 58 LZ (b)	A7	B28	0,9	F54
	1.4	KFV (TU3A)	53/72	02.2006		RFN 58 LZ3A (g)	A515		0,9	
	1.4	KFV, KFT (TU3A)	54/73	12.2007		RFC 58 LZK (a)	A11	B29	0,9	F54
	1.4	KFV, KFT (TU3A)	54/73	12.2007		RFN 58 LZ (b)	A7	B28	0,9	F54
	1.4	KFV, KFT (TU3A)	54/73	12.2007		RFN 58 LZ3A (g)	A515		0,9	
	1.4 16V	KFU (ET3J4)	65/88	02.2006		RWC 52 HSK	A197	B58	0,9	
	1.4 16V	8FS (EP3)	70/95	06.2007		RXC 58 HSEDP	A500		1.0	
	1.4 16V	8FR (EP3)	72/98	10.2009		RXC 42 HSEDP2A	A513		1.0	
	1.6 16V	NFU (TU5JP4)	80/109	02.2006		RFN 58 HZ	A158		0,9	
	1.6 16V	NFU (TU5JP4)	80/109	02.2006		RFN 58 HZ3A (g)	A516		0,9	
	1.6 VTi 120	5FW (EP6), 5FS (EP6C)	88/120	02.2007		RXC 58 HSEDP	A500		1.0	
	1.6 16V Turbo	5FX (EP6DT)	110/150	02.2006		RXN 62 HSDP	A525		0,7	
	1.6 16V Turbo	5FR (EP6DT)	115/156	10.2009		RXN 62 HSDP	A525		0,7	
	1.6 16V RC	5FY (EP6DTS)	128/174	02.2007		RXN 62 HSDP	A525		0,7	
207 CC (WD_)	1.6 16V	5FW (EP6), 5FS (EP6C)	88/120	02.2007		RXC 58 HSEDP	A500		1.0	
	1.6 16V Turbo	5FX (EP6DT)	110/150	02.2007		RXN 62 HSDP	A525		0,7	
	1.6 16V Turbo	5FR (EP6DT), EP6CDT	115/156	10.2009		RXN 62 HSDP	A525		0,7	
207 SW (WK_)	1.4	KFV, KFT (TU3A)	54/73	06.2007		RFC 58 LZK (a)	A11	B29	0,9	F54
	1.4	KFV, KFT (TU3A)	54/73	06.2007		RFN 58 LZ (b)	A7	B28	0,9	F54
	1.4	KFV, KFT (TU3A)	54/73	06.2007		RFN 58 LZ3A (g)	A515		0,9	
	1.4 16V	8FS (EP3), EP3C	70/95	06.2007	10.2009	RXC 58 HSEDP	A500		1.0	

(f) Available until end of stock

(a) 30 000 km

(b) 60 000 km

(c) Grey sticker on ignition coil

(d) Green sticker on ignition coil

(e) Hex 21 mm

(f) Hex 16 mm

(g) Recommended for cold weather

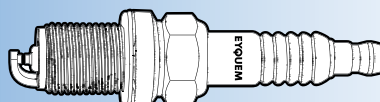

EYQUEM



Box
10

Blister
4



F3

PEUGEOT

	1.4 16 V	8FR (EP3)	72/98	11.2009		RXC 42 HSEDP2A	A513		1.0
	1.6 16V	5FW (EP6), 5FS (EP6C)	88/120	06.2007		RXC 58 HSEDP	A500		1.0
	1.6 16V Turbo	5FX (EP6DT)	110/150	02.2007		RXN 62 HSDP	A525		0.7
	1.6 16V RC	5FY (EP6DTS)	128/174	02.2007		RXN 62 HSDP	A525		0.7
208	NEW 1.0	ZMZ (EBO)	50/68	03.2012		RZN 32 HSWDP	A531		1.0
	NEW 1.2	HMZ (EB2F)	60/82	03.2012		RZN 32 HSWDP	A531		1.0
	NEW 1.2 THP	HNZ (EB2DT)	81/110	01.2013		RXN 72 HSIPFS	A541		0.75
	1.4 LPG	EP3C	70/95	10.2013		RXN 62 HSDP	A525		0.8
	1.4 VTi	8FS (EP3), EP3C	70/95	03.2012		RXC 42 HSEDP2A	A513		1.0
	1.6	5FS (EP6C)	88/120	02.2012		RXN 62 HSDP	A525		0.7
	1.6	EP6CDT, 5FV (EP6DT)	115/156	03.2012		RXN 62 HSDP	A525		0.7
	1.6 16V Turbo	5FX (EP6DT)	110/150	03.2012		RXN 62 HSDP	A525		0.7
	1.6 THP 165		121/165	03.2015		RXN 62 HSDP	A525		0.8
	1.6 GTi	5FU (EP6CDTX)	147/200	08.2012		RXN 62 HSDP	A525		0.7
2008	NEW 1.2 THP 110	HNZ (EB2DT)	81/110	01.2015		RXN 72 HSIPFS	A541		0.75
	NEW 1.2 THP 130	HNY (EB2DTS)	96/130	01.2015		RXN 72 HSIPFS	A541		0.75
	NEW 1.2 VTi	HMZ (EB2DF)	60/82	03.2013		RZN 32 HSWDP	A531		1.0
	1.6 VTi	EP6C	88/120	03.2013		RXN 62 HSDP	A525		0.7
301	NEW 1.2 VTi 72	HMY (EB2M)	53/72	11.2012		RZN 32 HSWDP	A531		1.0
	NEW 1.2 VTi 82		60/82	12.2014		RZN 32 HSWDP	A531		1.0
	1.6 VTi 115	NFP (EC5)	85/115	11.2012		RFN 52 HZ	A157	B50	0.9
	1.6 VTi 115	NFP (EC5)	85/115	11.2012		RFN 52 HZ 3A	A100		0.9
304 (_04M_)	1.3 GT	XL3	48/65	10.1969	08.1972	C 82 LS	A40	B6	0,6 L87
	1.3 GL	XL5	48/65	09.1972	08.1975	C 82 LS	A40	B6	0,6 L87
	1.3	XL5S	55/75	08.1972	09.1975	RC 72 LS	A32	B26	0,8 L87
	Tous modèles (all models)			10.1975		C 62 LJS	A19	B2	0,6 J65
304 Break (_04D_)	1.1	XK5	43/58	10.1976	10.1980	C 62 LJS	A19	B2	0,6 J65
	1.3	XL5	48/65	09.1970	09.1975	C 82 LS	A40	B6	0,6 L87
	1.3	XL5	48/65	10.1975	10.1980	C 62 LJS	A19	B2	0,6 J65
304 Coupe (_04C_)	1.3	XL3	48/65	03.1970	03.1973	C 82 LS	A40	B6	0,6 L87
	1.3	XL3S	55/75	03.1972	04.1975	C 82 LS	A40	B6	0,6 L87
304 Cabriolet (_04B_)	1.3	XL5	48/65	03.1970	09.1973	C 82 LS	A40	B6	0,6 L87
	1.3	XL3S	55/75	09.1972	09.1975	C 82 LS	A40	B6	0,6 L87
	1.3	XL3S	55/75	10.1975	07.1976	C 62 LJS	A19	B2	0,6 J65
305 I (581A)	1.3	118 (XL5)	44/60	11.1977	09.1982	C 62 LJS	A19	B2	0,6 J65
	1.5	142 (XR5)	54/73	11.1979	09.1982	C 62 LJS	A19	B2	0,6 J65
	1.5	117 (XR5S)	65/88	05.1980	09.1982	C 62 LJS	A19	B2	0,6 J65
305 I Break (581D)	1.3	118 (XL5)	44/60	08.1980	09.1982	C 62 LJS	A19	B2	0,6 J65
	1.5	142 (XR5)	54/73	08.1980	09.1982	C 62 LJS	A19	B2	0,6 J65
305 II (581M)	1.1 GL, SR	XK5	43/58	10.1982	06.1988	C 62 LJS	A19	B2	0,6 J65
	1.3 GL, GR	118, 118B, 118TR (XL5)	44/60	10.1982	08.1985	C 62 LJS	A19	B2	0,6 J65
	1.5 EXL, GL, GLS, GR, S, SR	142 (XR5A) (117,142X)	50-54/68 -73	10.1982	07.1990	C 62 LJS	A19	B2	0,6 J65
	1.6	XU5S [171C]	66/90	10.1982	07.1990	C 72 LJS	A22		0,6 J87
	1.6	BAZ (XU5CP), XU51C (B1A)	58/79	08.1987	07.1990	RFC 58 LZK (a)	A11	B29	0,6 F54
	1.6	171 (XU5S)	66/90	07.1984	08.1987	C 72 LJS	A22		0,6 J87
	1.6	171 (XU5S)	69/94	10.1982	06.1988	C 72 LJS	A22		0,6 J87
	1.6	171 (XU5S)	71/97	10.1982	06.1984	C 72 LJS	A22		0,6 J87
	1.9 i GTX, SR	DFZ (XU9J1)	72/98	07.1982	07.1987	C 62 LJS	A19	B2	0,6 J65
	1.9 i GTX, SR	DFZ (XU9J1)	72/98	08.1987	07.1990	RFC 58 LZK (a)	A11	B29	0,6 F54
	1.9 i GTX, SR	DFZ (XU9J1)	72/98	08.1987	07.1990	RFN 58 LZ (b)	A7	B28	0,9 F54
	1.9 GR, GT, GTX, SR	159 (XU9S)	75/102	10.1982	07.1990	C 72 LJS	A22		0,6 J87
	1.9 GTX, SR	XU92 C [D2A]	75/102	07.1982	07.1987	C 62 LJS	A19	B2	0,6 J65
	1.9 GTX, SR	XU92 C [D2A]	75/102	08.1987	07.1990	RFC 58 LZK (a)	A11	B29	0,6 F54
305 II Break (581E)	1.3	118 (XL5)	44/60	10.1982	08.1986	C 62 LJS	A19	B2	0,6 J65
	1.5	142 (XR5A)	50/68	09.1985	10.1986	C 62 LJS	A19	B2	0,6 J65
	1.5	142 (XR5)	54/73	10.1982	08.1986	C 62 LJS	A19	B2	0,6 J65
	1.6	BAZ (XU5CP)	54/73	11.1986	06.1987	C 62 LJS	A19	B2	0,6 J65
	1.6	BAZ (XU5CP)	54/73	07.1987	12.1988	RFC 58 LZK (a)	A11	B29	0,6 F54
	1.6	B1A (XU51C)	55/75	02.1986	06.1987	C 62 LJS	A19	B2	0,6 J65
	1.6	B1A (XU51C)	55/75	07.1987	12.1988	RFC 52 LS	A3	B16	0,9 F54
	1.6	171 (XU5S)	66/90	07.1984	12.1987	C 72 LJS	A22		0,6 J87
	1.6	171 (XU5S)	71/97	09.1983	06.1984	C 72 LJS	A22		0,6 J87
	1.9	DFZ (XU9J1)	72/98	11.1986	06.1987	C 72 LJS	A22		0,6 J87
	1.9	DFZ (XU9J1)	72/98	07.1987	12.1988	RFN 52 LZ	A27		0,9 F54
	1.9	159 (XU9S)	75/102	09.1984	10.1987	C 72 LJS	A22		0,6 J87

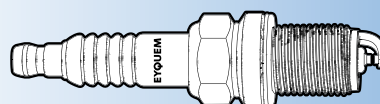

(1) Available until end of stock

- (a) 30 000 km
- (b) 60 000 km
- (c) Grey sticker on ignition coil
- (d) Green sticker on ignition coil

- (e) Hex 21 mm
- (f) Hex 16 mm
- (g) Recommended for cold weather



Box
10

Blister
4



F3-D1

PEUGEOT

306 (7A, 7C, N3, N5)	1.1 i	HDZ, HDY (TU1M)	40/54	05.1993	04.1997	RFC 58 LZK (a)	A11	B29	0,9	F54	
	1.1 i	HDZ, HDY (TU1M)	40/54	05.1993	04.1997	RFN 58 LZ (b)	A7	B28	0,9	F54	
	1.1 i	HDZ, HDY (TU1M)	40/54	05.1993	04.1997	RFN 58 LZ3A (g)	A515		0,9		
	1.1, Break	HDZ (TU1M)	44/60	06.1994	06.1995	RFN 52 LZ	A27		0,9	F54	
	1.1 Bahia, Open, XN	HDZ (TU1M)	44/60	07.1995	05.2001	RFC 42 LZ2E	A5	B30	0,9	F54	
	1.4 i	KDX (TU3MC)	55/75	07.1995	04.1997	RFC 58 LZ 2	A54		1,0	F54	
	1.4 i	KDX (TU3MC)	55/75	07.1995	04.1997	RFC 58 LZ 2	A54		1,0	F54	
	1.4 SL, Break	KDX (TU3MC), KFW (TU3JP), KFX (TU3JP)	55/75	07.1995	08.1996	RFC 58 LZ 2	A54		1,0	F54	
	1.4 i	KFX (TU3JP)	55/75	09.1996	05.2001	RFC 58 LZK (a)	A11	B29	0,9	F54	
	1.4 i	KFX (TU3JP)	55/75	09.1996	05.2001	RFN 58 LZ (b)	A7	B28	0,9	F54	
	1.4 i	KFX (TU3JP)	55/75	07.1995	05.2001	RFN 58 LZ3A (g)	A515		0,9		
	1.6 i	NFZ (TU5JP)	65/88	01.1993	06.1995	RFC 58 LS3	A16	B33	1,2	F54	
	1.6 i	NFZ (TU5JP)	65/88	07.1995	10.2000	RFC 58 LZK (a)	A11	B29	0,9	F54	
	1.6 i	NFZ (TU5JP)	65/88	07.1995	10.2000	RFN 58 LZ (b)	A7	B28	0,9	F54	
	1.6 i	NFZ (TU5JP)	65/88	07.1995	10.2000	RFN 58 LZ3A (g)	A515		0,9		
	1.6 i	NFZ (TU5JP)	66/90	07.2000	05.2001	RFC 58 LZK (a)	A11	B29	0,9	F54	
	1.6 i	NFZ (TU5JP)	66/90	07.2000	05.2001	RFN 58 LZ (b)	A7	B28	0,9	F54	
	1.6 i	NFZ (TU5JP)	66/90	07.2000	05.2001	RFN 58 LZ3A (g)	A515		0,9		
	1.6 i	NFT (TU5JP)	72/98	10.2000	05.2001	RFC 58 LZ 2	A54		1,0	F54	
	1.8 i 16V	LFY (XU7JP4)	81/110	04.1997	05.2001	RFC 42 LZ2E	A5	B30	0,9	F54	
	1.8 i	LFZ (XU7JP)	74/101	01.1993	05.2001	RFC 42 LZ2E	A5	B30	0,9	F54	
	2.0 i	RFX (XU10J2)]	89/121	05.1993	05.2001	RFC 42 LZ2E	A5	B30	0,9	F54	
	2.0 16V	RFV (XU10J4R)	97/132	03.1997	05.2001	RFC 58 LZ2E	A10	B31	0,9	F54	
	2.0 S16	RFT (XU10J4)	110/150	06.1994	05.2001	RFN 58 LZ (b)	A7	B28	0,9	F54	
	2.0 S16	RFT (XU10J4)	110/150	06.1994	05.2001	RFN 58 LZ3A (g)	A515		0,9		
2.0 S16	RFY (XU10J4Z)	112/152	05.1993	05.2001	RFN 58 LZ (b)	A7	B28	0,9	F54		
2.0 S16	RFY (XU10J4Z)	112/152	05.1993	05.2001	RFN 58 LZ3A (g)	A515		0,9			
2.0 S16	RFS (XU10JARS)	120/163	03.1996	05.2001	RFN 52 LZ	A27		0,9	F54		
306 (7B, N3, N5)	1.1	HDZ (TU1M)	44/60	06.1994	05.2001	RFC 42 LZ2E	A5	B30	0,9	F54	
	1.4 SL	KDX (TU3MC), KFW (TU3JP), KFX (TU3JP)	55/75	06.1994	05.2001	RFC 58 LZ 2	A54		1,0	F54	
	1.6 SR	NFZ (TU5JP)	66/90	06.1994	06.1995	RFC 58 LS3	A16	B33	1,2	F54	
	1.6 SR	NFZ (TU5JP)	66/90	07.1995	10.2000	RFN 58 LZ (b)	A7	B28	0,9	F54	
	1.6 SR	NFZ (TU5JP)	66/90	07.1995	10.2000	RFN 58 LZ3A (g)	A515		0,9		
	1.6	NFT (TU5JP)	72/98	10.2000	05.2001	RFC 58 LZ 2	A54		1,0	F54	
	1.8 16V	LFY (XU7JP4)	81/110	03.1997	05.2001	RFC 42 LZ2E	A5	B30	0,9	F54	
	1.8 ST	LFY (XU7JP4)	74/101	06.1994	05.2001	RFC 42 LZ2E	A5	B30	0,9	F54	
	2.0 ST	RFX (XU10J2)]	89/121	07.1994	05.2001	RFC 42 LZ2E	A5	B30	0,9	F54	
	2.0	RFV (XU10J4R)	97/132	03.1997	05.2001	RFC 58 LZ2E	A10	B31	0,9	F54	
	2.0 S16	RFT (XU10J4)	110/150	06.1994	05.2001	RFN 58 LZ (b)	A7	B28	0,9	F54	
	2.0 S16	RFT (XU10J4)	110/150	06.1994	05.2001	RFN 58 LZ3A (g)	A515		0,9		
	306 Break (7E, N3, N5)	1.4	KFX, KFW (TU3JP)	55/75	03.1997	04.2002	RFC 58 LZK (a)	A11	B29	0,9	F54
		1.4	KFX, KFW (TU3JP)	55/75	03.1997	04.2002	RFN 58 LZ (b)	A7	B28	0,9	F54
		1.4	KFX, KFW (TU3JP)	55/75	03.1997	04.2002	RFN 58 LZ3A (g)	A515		0,9	
1.6		NFZ (TU5JP)	66/90	03.1997	10.2000	RFC 58 LZK (a)	A11	B29	0,9	F54	
1.6		NFZ (TU5JP)	66/90	03.1997	10.2000	RFN 58 LZ (b)	A7	B28	0,9	F54	
1.6		NFZ (TU5JP)	66/90	03.1997	10.2000	RFN 58 LZ3A (g)	A515		0,9		
1.6		NFT (TU5JP)	72/98	10.2000	04.2002	RFC 58 LZK (a)	A11	B29	0,9	F54	
1.6		NFT (TU5JP)	72/98	10.2000	04.2002	RFN 58 LZ (b)	A7	B28	0,9	F54	
1.6		NFT (TU5JP)	72/98	10.2000	04.2002	RFN 58 LZ3A (g)	A515		0,9		
1.8 i		LFZ (XU7JP)	74/101	03.1993	04.2002	RFC 42 LZ2E	A5	B30	0,9	F54	
1.8 i 16V		LFY (XU7JP4)	81/110	03.1997	04.2002	RFC 42 LZ2E	A5	B30	0,9	F54	
2.0		RFV (XU10J4R)	97/132	03.1997	04.2002	RFC 58 LZ2E	A10	B31	0,9	F54	
306 Cabriolet (7D, N3, N5)	1.6	NFZ (TU5JP)	65/88	04.1996	10.2000	RFC 58 LZK (a)	A11	B29	0,9	F54	
	1.6	NFZ (TU5JP)	65/88	04.1996	10.2000	RFN 58 LZ (b)	A7	B28	0,9	F54	
	1.6	NFT (TU5JP)	72/98	10.2000	04.2002	RFN 58 LZ (b)	A7	B28	0,9	F54	
	1.6	NFT (TU5JP)	72/98	10.2000	04.2002	RFN 58 LZ3A (g)	A515		0,9		
	1.8 i 16V	LFY (XU7JP4)	81/110	07.2000	04.2002	RFC 42 LZ2E	A5	B30	0,9	F54	
	1.8 i	LFZ (XU7JP)	74/101	03.1994	04.2002	RFC 42 LZ2E	A5	B30	0,9	F54	
	2.0	RFX (XU10J2)]	89/121	03.1994	04.2002	RFC 42 LZ2E	A5	B30	0,9	F54	
	2.0 16V	RFV (XU10J4R)	97/132	03.1997	04.2002	RFC 58 LZ2E	A10	B31	0,9	F54	
307 (3A/C)	1.4 i	KFW (TU3JP)	55/75	08.2000		RFN 58 LZ (b)	A7	B28	0,9	F54	

(1) Available until end of stock

(a) 30 000 km

(b) 60 000 km

(c) Grey sticker on ignition coil

(d) Green sticker on ignition coil

(e) Hex 21 mm

(f) Hex 16 mm

(g) Recommended for cold weather



EYQUEM



Box 10
Blister 4



F3

PEUGEOT

	1.4 i	KFW (TU3JP)	55/75	08.2000		RFN 58 LZ3A (g)	A515		0,9	
	1.4 i 16V	KFU (ET3J4)	65/88	11.2003		RWC 52 HSK	A197	B58	0,9	
	1.6 i 16V	NFU (TU5JP4-L4)	80/109	08.2000		RFN 58 HZ	A158		0,9	
	1.6 i 16V	NFU (TU5JP4-L4)	80/109	08.2000		RFN 58 HZ3A (g)	A516		0,9	
	1.6 BioFlex	NFU (TU5JP4)	80/109	09.2007		RFN 58 HZ3A (g)	A516		0,9	
	2.0 i 16V	RFN (EW10J4-L4)	100/136	08.2000		RFN 52 HZ	A157	B50	0,9	
	2.0 i 16V	RFN (EW10J4-L4)	100/136	08.2000		RFN 52 HZ3A (g)	A100		0,9	
	2.0 i 16V	RFJ (EW10A), RFN (EW10J4)	103/140	03.2005		RFN 52 HZ	A157	B50	0,9	
	2.0 i 16V	RFJ (EW10A), RFN (EW10J4)	103/140	03.2005		RFN 52 HZ3A (g)	A100		0,9	
	2.0 i 16V	RFK (EW10J4S)	130/177	06.2005		RFN 52 HZ3A (g)	A100		0,9	
307 Break (3E)	1.4	KFW (TU3JP)	55/75	04.2002	09.2003	RFN 58 LZ (b)	A7	B28	0,9	F54
	1.4	KFW (TU3JP)	55/75	04.2002	09.2003	RFN 58 LZ3A (g)	A515		0,9	
	1.4 16V	KFU (ET3J4)	65/88	11.2003		RWC 52 HSK	A197	B58	0,9	
	1.6 i 16V	NFU (TU5JP4)	80/109	03.2002		RFN 58 HZ	A158		0,9	
	1.6 i 16V	NFU (TU5JP4)	80/109	03.2002		RFN 58 HZ3A (g)	A516		0,9	
	1.6 BioFlex	NFU (TU5JP4)	80/109	09.2007		RFN 58 HZ3A (g)	A516		0,9	
	2.0 16V	RFN (EW10J4)	100/136	03.2002		RFN 52 HZ	A157	B50	0,9	
	2.0 16V	RFN (EW10J4)	100/136	03.2002		RFN 52 HZ3A (g)	A100		0,9	
	2.0 i 16V	RFJ (EW10A)	103/140	03.2005		RFN 52 HZ3A (g)	A100		0,9	
	2.0 i 16V	RFK (EW10J4S)	130/177	06.2005		RFN 52 HZ3A (g)	A100		0,9	
307 SW (3H)	1.4 16V	KFU (ET3J4)	65/88	11.2003		RWC 52 HSK	A197	B58	0,9	
	1.6 i 16V	NFU (TU5JP4)	80/109	03.2002		RFN 58 HZ	A158		0,9	
	1.6 i 16V	NFU (TU5JP4)	80/109	03.2002		RFN 58 HZ3A (g)	A516		0,9	
	1.6 BioFlex	NFU (TU5JP4)	80/109	09.2007		RFN 58 HZ3A (g)	A516		0,9	
	2.0 16V	RFN (EW10J4)	100/136	03.2002		RFN 52 HZ	A157	B50	0,9	
	2.0 16V	RFN (EW10J4)	100/136	03.2002		RFN 52 HZ3A (g)	A100		0,9	
	2.0 16V	RFJ (EW10A)	103/140	03.2005		RFN 52 HZ3A (g)	A100		0,9	
307 CC (3B)	1.6 i 16V	NFU (TU5JP4)	80/109	02.2005		RFN 58 HZ	A158		0,9	
	1.6 i 16V	NFU (TU5JP4)	80/109	02.2005		RFN 58 HZ3A (g)	A516		0,9	
	2.0 16V	RFN (EW10J4)	100/136	10.2003		RFN 52 HZ	A157	B50	0,9	
	2.0 16V	RFN (EW10J4)	100/136	10.2003		RFN 52 HZ3A (g)	A100		0,9	
	2.0 16V	RFJ (EW10A)	103/140	03.2005		RFN 52 HZ3A (g)	A100		0,9	
	2.0 16V	RFK (EW10J4S)	130/177	06.2005		RFN 52 HZ3A (g)	A100		0,9	
308 (4A_, 4C_)	1.4 16V	8FS (EP3)	70/95	09.2007	12.2009	RXC 58 HSEDP	A500		1,0	
	1.4 16V	8FR (EP3C)	72/98	01.2010		RXC 42 HSEDP2A	A513		1,0	
	1.6 BioFlex	NFU (TU5JP)	80/109	04.2008		RFN 58 HZ	A158		0,9	
	1.6 BioFlex	NFU (TU5JP)	80/109	04.2008		RFN 58 HZ3A (g)	A516		0,9	
	1.6 VTi 120	5FW (EP6)	88/120	09.2007	12.2009	RXC 58 HSEDP	A500		1,0	
	1.6 16V	5FT (EP6DT)	103/140	09.2007		RXN 62 HSDP	A525		0,7	
	1.6 16V	5FX (EP6DT)	110/150	09.2007		RXN 62 HSDP	A525		0,7	
	1.6 16V	EP6CDT	115/156	10.2009		RXN 62 HSDP	A525		0,7	
	1.6 16V	5FY (EP6DTS)	128/174	03.2008		RXN 62 HSDP	A525		0,7	
308 CC	2.0 BioFlex	RFJ (EW10A)	103/140	01.2008	01.2012	RFN 52 HZ3A (g)	A100		0,9	
	1.6 VTi 120	EP6	88/120	08.2009		RXC 58 HSEDP	A500		1,0	
	1.6 16V	5FT (EP6DT)	103/140	06.2009		RXN 62 HSDP	A525		0,7	
	1.6 16V	5FX (EP6DT)	110/150	06.2009		RXN 62 HSDP	A525		0,7	
	1.6 16V	EP6CDT	115/156	06.2009		RXN 62 HSDP	A525		0,7	
308 SW	1.4 16V	8FS (EP3)	70/95	09.2007	12.2009	RXC 58 HSEDP	A500		1,0	
	1.4 16V	EP3	70/95	01.2010		RXC 42 HSEDP2A	A513		1,0	
	1.4 16V	8FR (EP3)	72/98	12.2009		RXC 42 HSEDP2A	A513		1,0	
	1.6 BioFlex	TU5JP	82/112	03.2009		RFN 58 HZ	A158		0,9	
	1.6 BioFlex	TU5JP	82/112	03.2009		RFN 58 HZ3A (g)	A516		0,9	
	1.6 VTi 120	5FW (EP6)	88/120	09.2007		RXC 58 HSEDP	A500		1,0	
	1.6 16V	5FT (EP6DT)	103/140	09.2007		RXN 62 HSDP	A525		0,7	
	1.6 16V	5FX (EP6DT)	110/150	09.2007		RXN 62 HSDP	A525		0,7	
	1.6 16V	EP6CDT	115/156	10.2009		RXN 62 HSDP	A525		0,7	
	1.6 16V	5FY (EP6DTS)	128/174	03.2008		RXN 62 HSDP	A525		0,7	
308 II	NEW 1.2 THP 110	HNZ (EB2DT)	81/110	11.2013		RXN 72 HSI PFS	A541		0,75	
	NEW 1.2 THP 130	HNY (EB2DTS)	96/131	11.2013		RXN 72 HSI PFS	A541		0,75	
	NEW 1.2 VTi	HMZ (EB2F)	60/82	09.2013		RZN 32 HSWDP	A531		1,0	
	1.6 VTi		85/115	03.2014		RFN 52 HZ3A (g)	A100		0,9	
	1.6 THP 125		92/125	09.2013		RXN 62 HSDP	A525		0,7	
	1.6	5FV (EP6DT)	115/156	09.2013		RXN 62 HSDP	A525		0,7	
	1.6 THP 150		110/150	03.2014		RXN 62 HSDP	A525		0,8	
	1.6 THP 163	5FV (EP6DT)	120/163	06.2014		RXN 62 HSDP	A525		0,8	

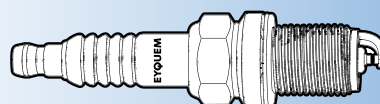

(1) Available until end of stock

- (a) 30 000 km
- (b) 60 000 km
- (c) Grey sticker on ignition coil
- (d) Green sticker on ignition coil

- (e) Hex 21 mm
- (f) Hex 16 mm
- (g) Recommended for cold weather



KW/HP



Box
10

Blister
4



F3-1

PEUGEOT

308 SW II	NEW	1.2 THP 110	HNZ (EB2DT)	81/110	03.2014		RXN 72 HSIPFS	A541	0.75		
	NEW	1.2 THP 130	HNY (EB2DTS)	96/131	03.2014		RXN 72 HSIPFS	A541	0.75		
		1.6 VTi			85/115	03.2014		RFN 52 HZ3A (g)	A100	0,9	
		1.6 THP 125			92/125	03.2014		RXN 62 HSDP	A525	0.7	
		1.6 THP 150			110/150	03.2014		RXN 62 HSDP	A525	0.8	
		1.6 THP 155	5FV (EP6DT)		115/156	03.2014		RXN 62 HSDP	A525	0.7	
		1.6 THP 163	5GZ (EP6FDT)		120/163	06.2014		RXN 62 HSDP	A525	0.8	
3008 Monospace (OU_)	NEW	1.2	HNY (EB2DTS)	96/131	01.2015		RXN 72 HSIPFS	A541	0.75		
		1.6 THP	5FX (EP6DT)		110/150	06.2009		RXN 62 HSDP	A525	0.7	
		1.6 THP	5FV (EP6DT)		115/156	06.2009		RXN 62 HSDP	A525	0.7	
		1.6 Turbo	5GZ (EP6FDT)		121/165	05.2014		RXN 62 HSDP	A525	0.8	
		1.6 VTi	EP6C		88/120	06.2009		RXC 58 HSEDP	A500	1.0	
3008 SUV (M_)	NEW	1.2	HNY (EB2DTS)	96/131	05.2016		RXN 72 HSIPFS	A541	0.75		
		1.6 THP 165	5GZ (EP6FDT)		121/165	05.2016		RXN 62 HSDP	A525	0.8	
309 I (10C, 10A)		1.1	E1	40/54	10.1985	07.1989	FC 42 LS	A15	B14	0,8	F54
		1.3	G1A	47/64	10.1985	07.1989	FC 52 LS	A2	B9	0,8	F54
		1.4	K1D (TU3A)	49/67	03.1989	07.1989	FC 52 LS	A2	B9	0,8	F54
		1.4	KDZ, KDY (TU3M)	55/75	03.1989	07.1989	FC 52 LS	A2	B9	0,8	F54
		1.4	K2B (TU3S)	62/84	03.1989	07.1989	RFC 58 LZK (a)	A11	B29	0,9	F54
		1.5	Y2/K	63/86	06.1987	12.1989	FC 52 LS	A2	B9	0,8	F54
		1.6	B1E (XU51C)	53/72	07.1987	07.1989	RFC 58 LZK (a)	A11	B29	0,9	F54
		1.6	B1A (XU51C)	55/75	10.1985	06.1987	C 62 LJS	A19	B2	0,6	J65
		1.6	B1A (XU51C)	55/75	07.1987	07.1989	RFC 58 LZK (a)	A11	B29	0,9	F54
		1.6	BAZ (XU5CP)	55/75	09.1986	06.1987	C 62 LJS	A19	B2	0,6	J65
		1.6 KAT	BAZ (XU5CP)	55/75	07.1987	12.1989	RFC 58 LZK (a)	A11	B29	0,9	F54
		1.6	B1D, B1A (XU51C)	59/80	10.1985	06.1987	C 62 LJS	A19	B2	0,6	J65
		1.6	B1D, B1A (XU51C)	59/80	07.1987	07.1989	RFC 58 LZK (a)	A11	B29	0,9	F54
		1.6	B6B (XU5J), 180Z (XU5J)	76/103	10.1985	07.1987	C 72 LJS	A22		0,6	J87
		1.6	B6B (XU5J), 180Z (XU5J)	76/103	08.1987	09.1988	RFC 58 LZK (a)	A11	B29	0,9	F54
		1.6		69/94	01.1986	07.1989	FC 52 LS	A2	B9	0,8	F54
		1.6 i	B6D, B6E (XU5JA)	83/113	07.1986	06.1987	C 72 LJS	A22		0,6	J87
		1.6 i	B6D, B6E (XU5JA)	83/113	07.1987	06.1989	RFC 58 LZK (a)	A11	B29	0,9	F54
		1.9	DFZ (XU9J1)	72/98	03.1986	07.1987	C 62 LJS	A19	B2	0,6	J65
		1.9	DFZ (XU9J1)	72/98	08.1987	07.1989	RFC 58 LZK (a)	A11	B29	0,9	F54
		1.9	D2B (XU9S)	75/102	10.1985	07.1987	C 72 LJS	A22		0,6	J87
		1.9	D2B (XU9S)	75/102	08.1987	07.1989	RFC 58 LZK (a)	A11	B29	0,9	F54
		1.9	DDZ (XU9M)	80/109	07.1988	07.1989	RFC 58 LZK (a)	A11	B29	0,9	F54
		1.9	DDZ (XU9M)	80/109	07.1988	07.1989	RFN 58 LZ (b)	A7	B28	0,9	F54
		1.9 GTI	DKZ (XU9JAZ)	88/120	07.1988	07.1989	RFN 58 LZ (b)	A7	B28	0,9	F54
		1.9 GTI	XU9 JA [D6B]	94/128	10.1986	07.1989	RFN 58 LZ (b)	A7	B28	0,9	F54
	309 II (3C, 3A)		1.1	H1A, H1B (TU1)	40/54	07.1989	12.1993	RFC 58 LZK (a)	A11	B29	0,9
		1.1	HDZ (TU1M)	44/60	08.1990	12.1993	RFN 52 LZ	A27		0,9	F54
		1.1 i	TU1M [HDY]	40/54	10.1990	12.1993	RFC 58 LZK (a)	A11	B29	0,9	F54
		1.1 i	TU1M [HDY]	40/54	10.1990	12.1993	RFN 58 LZ (b)	A7	B28	0,9	F54
		1.1 i	TU1M [HDY]	40/54	10.1990	12.1993	RFN 58 LZ3A (g)	A515		0,9	
		1.3	G1 [G1A-G1B] - G2 [G2S]	47/64	10.1985	12.1991	RFC 58 LZK (a)	A11	B29	0,9	F54
		1.4	K1D, K1F, K1G, K2D, K3A (TU3A)	49/67	01.1989	12.1993	RFC 58 LZK (a)	A11	B29	0,9	F54
		1.4	K1D, K1F, K1G, K2D, K3A (TU3A)	49/67	01.1989	12.1993	RFN 58 LZ (b)	A7	B28	0,9	F54
		1.4	Y2	61/83	10.1986	12.1991	RFC 58 LZK (a)	A11	B29	0,9	F54
		1.4	KDZ, KDY (TU3M)	55/75	07.1989	12.1993	RFC 58 LZK (a)	A11	B29	0,9	F54
		1.4	KDZ, KDY (TU3M)	55/75	07.1989	12.1993	RFN 58 LZ (b)	A7	B28	0,9	F54
		1.4	KDZ, KDY (TU3M)	55/75	07.1989	12.1993	RFN 58 LZ3A (g)	A515		0,9	
		1.6	BDZ (XU5M), BDY (XU5M3Z, XU5M2Z)	65/88	07.1989	12.1993	RFC 58 LZK (a)	A11	B29	0,9	F54
		1.6	BDZ (XU5M), BDY (XU5M3Z, XU5M2Z)	65/88	07.1989	12.1993	RFN 58 LZ (b)	A7	B28	0,9	F54
		1.6	BDZ (XU5M), BDY (XU5M3Z, XU5M2Z)	65/88	07.1989	12.1993	RFN 58 LZ3A (g)	A515		0,9	
		1.6	B2A, B2B, B2C, B5A (XU52C/K)	68-69/92-94	07.1988	12.1993	RFC 58 LZK (a)	A11	B29	0,9	F54

- (1) Available until end of stock
- (a) 30 000 km
- (b) 60 000 km
- (c) Grey sticker on ignition coil
- (d) Green sticker on ignition coil

- (e) Hex 21 mm
- (f) Hex 16 mm
- (g) Recommended for cold weather



EYQUEM



Box
10

Blister
4



PEUGEOT

	1.6	B2A, B2B, B2C, B5A (XU52C/K)	68-69/92-94	07.1988	12.1993	RFN 58 LZ (b)	A7	B28	0,9	F54
	1.6	B2A, B2B, B2C, B5A (XU52C/K)	68-69/92-94	07.1988	12.1993	RFN 58 LZ3A (g)	A515		0,9	
	1.9	DFZ (XU9J1)	72/98	08.1989	12.1993	RFC 58 LZK (a)	A11	B29	0,9	F54
	1.9	DFZ (XU9J1)	72/98	08.1989	12.1993	RFN 58 LZ (b)	A7	B28	0,9	F54
	1.9	DFZ (XU9J1)	72/98	08.1989	12.1993	RFN 58 LZ3A (g)	A515		0,9	
	1.9	DDZ (XU9M)	80/109	10.1990	12.1993	RFN 58 LZ (b)	A7	B28	0,9	F54
	1.9	DDZ (XU9M)	80/109	10.1990	12.1993	RFN 58 LZ3A (g)	A515		0,9	
	1.9 GTI	DKZ, DFY (XU9JA-Z)	88-90/120-122	07.1989	12.1993	RFN 58 LZ (b)	A7	B28	0,9	F54
	1.9 GTI	DKZ, DFY (XU9JA-Z)	88-90/120-122	07.1989	12.1993	RFN 58 LZ3A (g)	A515		0,9	
	1.9 i 16V GTI 16S	DFW (XU9 J4-Z)	108/147	07.1990	12.1993	RFC 58 LS3	A16	B33	1,2	
	1.9 i 16V GTI 16S	D6C (XU9J4)	117/160	07.1990	12.1993	RFC 62 LS3	A56		1,2	
404	Modèles à carburateur (carburetor models)			10.1963	12.1971	C 52 LS	A1	B1	0,6	L65
	Modèles à injection (injection models)			10.1963	12.1971	C 82 LS	A40	B6	0,6	L87
405 I (15B)	1.4	K5A (TU3), K1G, K1A	44/60		06.1992	RFC 58 LZK (a)	A11	B29	0,9	F54
	1.4	K5A (TU3, TU3TR)	47/64	01.1987	07.1992	RFC 58 LZK (a)	A11	B29	0,9	F54
	1.4	K5A (TU3, TU3TR)	47/64	01.1987	07.1992	RFN 58 LZ (b)	A7	B28	0,9	F54
	1.4	K5A (TU3, TU3TR)	47/64	01.1987	07.1992	RFN 58 LZ3A (g)	A515		0,9	
	1.6	B1E, B1D (XU51C)	53/72	07.1987	12.1992	RFC 58 LZK (a)	A11	B29	0,9	F54
	1.6	B1E, B1D (XU51C)	53/72	07.1987	12.1992	RFN 58 LZ (b)	A7	B28	0,9	F54
	1.6	B1E, B1D (XU51C)	53/72	07.1987	12.1992	RFN 58 LZ3A (g)	A515		0,9	
	1.6	BAZ (XU5CP)	55/75	07.1987	06.1988	FN 52 LS	A41		0,8	F54
	1.6	BDZ (XU5M), BDY (XU5M2Z) 65/88	65/88	07.1987	12.1992	RFC 58 LZK (a)	A11	B29	0,9	F54
	1.6	BDZ (XU5M), BDY (XU5M2Z) 65/88	65/88	07.1987	12.1992	RFN 58 LZ (b)	A7	B28	0,9	F54
	1.6	BDZ (XU5M), BDY (XU5M2Z) 65/88	65/88	07.1987	12.1992	RFN 58 LZ3A (g)	A515		0,9	
	1.6	BDZ (XU5M)	66/90	10.1989	12.1992	RFC 58 LZK (a)	A11	B29	0,9	F54
	1.6	BDZ (XU5M)	66/90	10.1989	12.1992	RFN 58 LZ (b)	A7	B28	0,9	F54
	1.6	BDZ (XU5M)	66/90	10.1989	12.1992	RFN 58 LZ3A (g)	A515		0,9	
	1.6	B2A, B2B, B2C, B5A (XU52C/K)	69/94	01.1987	12.1992	RFC 58 LZK (a)	A11	B29	0,9	F54
	1.6	B2A, B2B, B2C, B5A (XU52C/K)	69/94	01.1987	12.1992	RFN 58 LZ (b)	A7	B28	0,9	F54
	1.6	B2A, B2B, B2C, B5A (XU52C/K)	69/94	01.1987	12.1992	RFN 58 LZ3A (g)	A515		0,9	
	1.9	D2C (XU92C)	70/95	07.1987	12.1992	RFC 58 LZK (a)	A11	B29	0,9	F54
	1.9	D2C (XU92C)	70/95	07.1987	12.1992	RFN 58 LZ (b)	A7	B28	0,9	F54
	1.9	D2C (XU92C)	70/95	07.1987	12.1992	RFN 58 LZ3A (g)	A515		0,9	
	1.9 injection	DFZ (XU9J1)	77/105	07.1987	12.1992	RFN 58 LZ (b)	A7	B28	0,9	F54
	1.9 injection	DFZ (XU9J1)	77/105	07.1987	12.1992	RFN 58 LZ3A (g)	A515		0,9	
	1.9	DDZ (XU9M)	80/109	07.1988	12.1992	RFN 58 LZ (b)	A7	B28	0,9	F54
	1.9	DDZ (XU9M)	80/109	07.1988	12.1992	RFN 58 LZ3A (g)	A515		0,9	
	1.9	DKZ (XU9JAZ)	88/120	07.1988	12.1992	RFN 58 LZ (b)	A7	B28	0,9	F54
	1.9	DKZ (XU9JAZ)	88/120	07.1988	12.1992	RFN 58 LZ3A (g)	A515		0,9	
	1.9	D6A (XU9J2)	93/126	07.1987	12.1993	RFN 58 LZ (b)	A7	B28	0,9	F54
	1.9	D6A (XU9J2)	93/126	07.1987	12.1993	RFN 58 LZ3A (g)	A515		0,9	
	1.9 Sport MI-16, MI-16 4x4	DFW (XU9J4-Z)	108/147	04.1988	12.1992	RFC 58 LS3	A16	B33	1,2	
	1.9 Sport MI-16	D6C (XU9J4)	116/158	07.1987	11.1991	RFC 62 LS3	A56		1,2	
405 I Break (15E)	1.4	K5A (TU3, TU3TR)	47/64	05.1988	07.1992	RFC 58 LZK (a)	A11	B29	0,9	F54
	1.4	K5A (TU3, TU3TR)	47/64	05.1988	07.1992	RFN 58 LZ (b)	A7	B28	0,9	F54
	1.6	B1E, B1D (XU51C)	53/72	10.1988	08.1992	RFC 58 LZK (a)	A11	B29	0,9	F54
	1.6	B1E, B1D (XU51C)	53/72	10.1988	08.1992	RFN 58 LZ (b)	A7	B28	0,9	F54
	1.6	B1E, B1D (XU51C)	53/72	10.1988	08.1992	RFN 58 LZ3A (g)	A515		0,9	
	1.6	BAZ (XU5CP)	55/75	10.1988	08.1992	FN 52 LS	A41		0,8	F54
	1.6	BDZ (XU5M), BDY (XU5M2Z) 65/88	65/88	10.1988	08.1992	RFC 58 LZK (a)	A11	B29	0,9	F54
	1.6	BDZ (XU5M), BDY (XU5M2Z) 65/88	65/88	10.1988	08.1992	RFN 58 LZ (b)	A7	B28	0,9	F54
	1.6	BDZ (XU5M), BDY (XU5M2Z) 65/88	65/88	10.1988	08.1992	RFN 58 LZ3A (g)	A515		0,9	
	1.6	BDZ (XU5M)	66/90	10.1988	08.1992	RFC 58 LZK (a)	A11	B29	0,9	F54
	1.6	BDZ (XU5M)	66/90	10.1988	08.1992	RFN 58 LZ (b)	A7	B28	0,9	F54
	1.6	BDZ (XU5M)	66/90	10.1988	08.1992	RFN 58 LZ3A (g)	A515		0,9	
	1.6	B2A (XU52C/K)	68/92	05.1988	07.1992	RFC 58 LZK (a)	A11	B29	0,9	F54
	1.6	B2A (XU52C/K)	68/92	05.1988	07.1992	RFN 58 LZ (b)	A7	B28	0,9	F54
	1.6	B2A (XU52C/K)	68/92	05.1988	07.1992	RFN 58 LZ3A (g)	A515		0,9	
	1.6	B2A (XU52C/K)	68/92	05.1988	08.1992	RFC 58 LZK (a)	A11	B29	0,9	F54

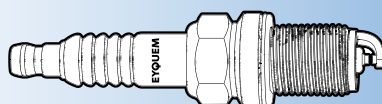

(1) Available until end of stock

- (a) 30 000 km
- (b) 60 000 km
- (c) Grey sticker on ignition coil
- (d) Green sticker on ignition coil

- (e) Hex 21 mm
- (f) Hex 16 mm
- (g) Recommended for cold weather



Box
10 Blister
4



F3→1

PEUGEOT

	1.6		69/94	10.1988	08.1992	RFN 58 LZ (b)	A7	B28	0,9	F54
	1.6		69/94	10.1988	08.1992	RFN 58 LZ3A (g)	A515		0,9	
	1.9	D2C (XU92C)	70/95	10.1988	08.1992	RFC 58 LZK (a)	A11	B29	0,9	F54
	1.9	D2C (XU92C)	70/95	10.1988	08.1992	RFN 58 LZ (b)	A7	B28	0,9	F54
	1.9	D2C (XU92C)	70/95	10.1988	08.1992	RFN 58 LZ3A (g)	A515		0,9	
	1.9	DFZ (XU9J1)	72/98	05.1988	07.1992	RFC 58 LZK (a)	A11	B29	0,9	F54
	1.9	DFZ (XU9J1)	72/98	05.1988	07.1992	RFN 58 LZ (b)	A7	B28	0,9	F54
	1.9	DFZ (XU9J1)	72/98	05.1988	07.1992	RFN 58 LZ3A (g)	A515		0,9	
	1.9	DFZ (XU9J1)	77/105	10.1988	08.1992	RFN 58 LZ (b)	A7	B28	0,9	F54
	1.9	DFZ (XU9J1)	77/105	10.1988	08.1992	RFN 58 LZ3A (g)	A515		0,9	
	1.9	DDZ (XU9M)	80/109	10.1988	08.1992	RFN 58 LZ (b)	A7	B28	0,9	F54
	1.9	DDZ (XU9M)	80/109	10.1988	08.1992	RFN 58 LZ3A (g)	A515		0,9	
	1.9	DKZ (XU9JAZ)	88/120	10.1988	08.1992	RFN 58 LZ (b)	A7	B28	0,9	F54
	1.9	DKZ (XU9JAZ)	88/120	10.1988	08.1992	RFN 58 LZ3A (g)	A515		0,9	
405 II (4B)	1.4	KDX (TU3MC)	55/75	07.1995		RFC 58 LZ 2	A54		1,0	F54
	1.4	KDX (TU3MC)	55/75	08.1992	06.1995	RFC 58 LZK (a)	A11	B29	0,9	F54
	1.4	KDX (TU3MC)	55/75	08.1992	06.1995	RFN 58 LZ (b)	A7	B28	0,9	F54
	1.4	KDX (TU3MC)	55/75	08.1992	06.1995	RFN 58 LZ3A (g)	A515		0,9	
	1.6	BFZ (XU5JP), BDZ (XU5M), BDY (XU5M3Z, XU5M2Z)	65/88	08.1992	10.1995	RFC 58 LZK (a)	A11	B29	0,9	F54
	1.6	BFZ (XU5JP), BDZ (XU5M), BDY (XU5M3Z, XU5M2Z)	65/88	08.1992	10.1995	RFN 58 LZ (b)	A7	B28	0,9	F54
	1.6	BFZ (XU5JP), BDZ (XU5M), BDY (XU5M3Z, XU5M2Z)	65/88	08.1992	10.1995	RFN 58 LZ3A (g)	A515		0,9	
	1.8	LFZ (XU7JP)	70-74/95-101	07.1995		RFC 42 LZ2E	A5	B30	0,9	F54
	1.8	LFZ (XU7JP)	70-74/95-101	06.1992	06.1995	RFC 58 LZK (a)	A11	B29	0,9	F54
	1.8	LFZ (XU7JP)	70-74/95-101	06.1992	06.1995	RFN 58 LZ (b)	A7	B28	0,9	F54
	1.8	LFZ (XU7JP)	70-74/95-101	06.1992	06.1995	RFN 58 LZ3A (g)	A515		0,9	
	2.0 SRI, STI, SRX4, Signature	RFX (XU10J2C)	89/121	07.1995		RFC 42 LZ2E	A5	B30	0,9	F54
	2.0 SRI, STI, SRX4, Signature	RFX (XU10J2C)	89/121	08.1992	06.1995	RFC 58 LZK (a)	A11	B29	0,9	F54
	2.0 SRI, STI, SRX4, Signature	RFX (XU10J2C)	89/121	08.1992	06.1995	RFN 58 LZ (b)	A7	B28	0,9	F54
	2.0 SRI, STI, SRX4, Signature	RFX (XU10J2C)	89/121	08.1992	06.1995	RFN 58 LZ3A (g)	A515		0,9	
	2.0 16V	RFT (XU10J4)	110/150	06.1994	10.1995	RFN 58 LZ (b)	A7	B28	0,9	F54
	2.0 16V	RFT (XU10J4)	110/150	06.1994	10.1995	RFN 58 LZ3A (g)	A515		0,9	
	2.0 MI-16, Le Mans	RFY (XU10J4-Z)	112/152	08.1992	10.1995	RFN 58 LZ (b)	A7	B28	0,9	F54
	2.0 MI-16, Le Mans	RFY (XU10J4-Z)	112/152	08.1992	10.1995	RFN 58 LZ3A (g)	A515		0,9	
	2.0 T16	RGZ (XU10J4TE/Z)	147/200	08.1992	10.1995	RFC 58 LS3	A16	B33	1,2	
405 II Break (4E)	1.4		58/79	07.1993	06.1994	RFN 58 LZ (b)	A7	B28	0,9	F54
	1.4		58/79	07.1993	06.1994	RFN 58 LZ3A (g)	A515		0,9	
	1.4	KDX (TU3MC)	55/75	08.1992	10.1996	RFC 58 LZK (a)	A11	B29	0,9	F54
	1.4	KDX (TU3MC)	55/75	08.1992	10.1996	RFN 58 LZ (b)	A7	B28	0,9	F54
	1.6	BFZ (XU5JP), BDZ (XU5M), BDY (XU5M3Z, XU5M2Z)	65/88	08.1992	10.1996	RFC 58 LZK (a)	A11	B29	0,9	F54
	1.6	BFZ (XU5JP), BDZ (XU5M), BDY (XU5M3Z, XU5M2Z)	65/88	08.1992	10.1996	RFN 58 LZ (b)	A7	B28	0,9	F54
	1.6	BFZ (XU5JP), BDZ (XU5M), BDY (XU5M3Z, XU5M2Z)	65/88	08.1992	10.1996	RFN 58 LZ3A (g)	A515		0,9	
	1.8	LFZ (XU7JP)	74/101	07.1995		RFC 42 LZ2E	A5	B30	0,9	F54
	1.8	LFZ (XU7JP)	74/101	08.1992	06.1995	RFN 58 LZ (b)	A7	B28	0,9	F54
	1.8	LFZ (XU7JP)	74/101	08.1992	06.1995	RFN 58 LZ3A (g)	A515		0,9	
	2.0	RFX (XU10J2C)	89/121	07.1995		RFC 42 LZ2E	A5	B30	0,9	F54
	2.0	RFX (XU10J2C)	89/121	08.1992	06.1995	RFN 58 LZ (b)	A7	B28	0,9	F54
	2.0	RFX (XU10J2C)	89/121	08.1992	06.1995	RFN 58 LZ3A (g)	A515		0,9	
406	1.8 SL, ST, LX, SL, Break	XU7JP/XU7JP4	81/110	11.1995	10.2000	RFC 42 LZ2E	A5	B30	0,9	F54
	1.8,Break	LFX (XU7JB)	66/90	05.1997	05.2004	RFC 42 LZ2E	A5	B30	0,9	F54
	1.8 16V,Break	LFY (XU7JP4)	81/110	11.1995	10.2000	RFC 42 LZ2E	A5	B30	0,9	F54
	1.8 i	XU7JB	66/90	07.1995	05.2004	RFC 58 LZ 2	A54		1,0	F54
	1.8 i	XU7 JP [L6A] - XU7 JB [LFX]	66-70/90-95	01.1995		RFC 42 LZ2E	A5	B30	0,9	F54
	1.8 i	XU7 JP [L6A] - XU7 JB [LFX]	66-70/90-95	01.1995		RFC 42 LZ2E	A5	B30	0,9	F54
	1.8 i	XU7 JP [L6A] - XU7 JB [LFX]	66-70/90-95	01.1995		RFC 42 LZ2E	A5	B30	0,9	F54
	1.8 i 16V	XU7 JP4 [LFY]	81/110	01.1995		RFC 42 LZ2E	A5	B30	0,9	F54
	1.8 i 16V	XU7 JP4 [LFY]	81/110	01.1995		RFC 42 LZ2E	A5	B30	0,9	F54
	1.8 i	XU7JB	66/90	07.1995	05.2004	RFC 58 LZ 2	A54		1,0	F54
	2.0 ST, SV, LX, Executive, GLX, Auto	XU10J4R	97/132	11.1995	05.2004	RFC 42 LZ2E	A5	B30	0,9	F54
	2.0 16V,Break	RFV (XU10J4R)	97/132	11.1995	05.2004	RFC 42 LZ2E	A5	B30	0,9	F54

(1) Available until end of stock

(a) 30 000 km

(b) 60 000 km

(c) Grey sticker on ignition coil

(d) Green sticker on ignition coil

(e) Hex 21 mm

(f) Hex 16 mm

(g) Recommended for

cold weather



EYQUEM



Box
10

Blister
4



F3

PEUGEOT

	2.0 i 16V	XU10 J4R [R6E] [RFV]	100/136	01.1995		RFC 42 LZ2E	A5	B30	0,9	F54
	2.0 i 16V	EW10 J4 [RFN] [DOHC] [RFR]	100/136	05.1999	08.2000	RFN 52 HZ	A157	B50	0,9	
	2.0 i 16V	EW10 J4 [RFN] [DOHC] [RFR]	100/136	05.1999	08.2000	RFN 52 HZ3A (g)	A100		0,9	
	2.0 i 16V	XU10 J4R [R6E] [RFV]	100/136	01.1995		RFN 58 LZ3A (g)	A515		0,9	
	3.0 V6	XFX (ES9J4S)	152/207	03.2000	05.2004	RFC 58 HZEDP5	A191		1,1	
406 (8B)	1.6	BFZ (XU5JP)	65/88	11.1995	05.2004	RFC 42 LZ2E	A5	B30	0,9	F54
	1.8 i 16V	6FZ (EW7J4)	85/115	10.2000	05.2004	RFN 52 HZ	A157	B50	0,9	
	1.8 i 16V	6FZ (EW7J4)	85/115	10.2000	05.2004	RFN 52 HZ3A (g)	A100		0,9	
	1.8 i	LFX (XU7JB)	66/90	07.1997	05.2004	RFC 58 LZ 2	A54		1,0	F54
	1.8 16V	LFY (XU7JP4)	81/110	11.1995	10.2000	RFC 42 LZ2E	A5	B30	0,9	F54
	2.0 16V	RFR (DEW10J4)	99/135	01.1999	08.2000	RFN 52 HZ	A157	B50	0,9	
	2.0 16V	RFR (DEW10J4)	99/135	01.1999	08.2000	RFN 52 HZ3A (g)	A100		0,9	
	2.0 16V	RFN (EW10J4)	100/136	08.2000	06.2004	RFN 52 HZ	A157	B50	0,9	
	2.0 16V	RFN (EW10J4)	100/136	08.2000	06.2004	RFN 52 HZ3A (g)	A100		0,9	
	2.0 16V HPI	RLZ (EW10D)	103/140	05.2001	05.2004	RXC 42 HZGP5	A506		1,0	
	2.0 16V	RFV (XU10J4R)	97/132	11.1995	05.2004	RFC 42 LZ2E	A5	B30	0,9	F54
	2.0 Turbo	RGX (XU10J2TE)	108/147	04.1996	05.2004	RFC 58 LZ2E	A10	B31	0,9	F54
	2.2	3FZ (EW12J4)	116/158	07.2000	05.2004	RFN 52 HZ	A157	B50	0,9	
	2.2	3FZ (EW12J4)	116/158	07.2000	05.2004	RFN 52 HZ3A (g)	A100		0,9	
	3.0 24V	XFZ (ES9J4)	140/190	10.1996	05.2004	RFC 58 LZ 2	A54		1,0	F54
	3.0 V6	XFX (ES9J4S)	152/207	03.2000	05.2004	RFC 58 HZEDP5	A191		1,1	
406 Break (8E/F)	1.8 i 16V	6FZ (EW7J4)	85/115	10.2000	05.2004	RFN 52 HZ	A157	B50	0,9	
	1.8 i 16V	6FZ (EW7J4)	85/115	10.2000	05.2004	RFN 52 HZ3A (g)	A100		0,9	
	1.8 i	LFX (XU7JB)	66/90	07.1997	10.2004	RFC 58 LZ 2	A54		1,0	F54
	1.8 i 16V	LFY (XU7JP4)	81/110	10.1996	10.2000	RFC 42 LZ2E	A5	B30	0,9	F54
	2.0 16V	RFR (DEW10J4)	99/135	01.1999	08.2000	RFN 52 HZ	A157	B50	0,9	
	2.0 16V	RFR (DEW10J4)	99/135	01.1999	08.2000	RFN 52 HZ3A (g)	A100		0,9	
	2.0 16V	RFN (EW10J4)	100/136	10.2000	10.2004	RFN 52 HZ	A157	B50	0,9	
	2.0 16V	RFN (EW10J4)	100/136	10.2000	10.2004	RFN 52 HZ3A (g)	A100		0,9	
	2.0 16V HPI	RLZ (EW10D)	103/140	05.2001	10.2004	RXC 42 HZGP5	A506		1,0	
	2.0 16V	RFV (XU10J4R)	97/132	10.1996	10.2004	RFC 42 LZ2E	A5	B30	0,9	F54
	2.0 Turbo	RGX (XU10J2TE)	108/147	10.1996	10.2004	RFC 58 LZ2E	A10	B31	0,9	F54
	2.2	3FZ (EW12J4)	116/158	07.2000	10.2004	RFN 52 HZ	A157	B50	0,9	
	2.2	3FZ (EW12J4)	116/158	07.2000	10.2004	RFN 52 HZ3A (g)	A100		0,9	
	3.0 24V	XFZ (ES9J4)	140/190	10.1996	10.2004	RFC 58 LZ 2	A54		1,0	F54
	3.0 24V	XFX (ES9J4S)	152/207	03.2000	05.2004	RFC 58 HZEDP5	A191		1,1	
406 Coupe (8C)	2.0 16V	RFR (DEW10J4)	99/135	01.1999	10.2000	RFN 52 HZ	A157	B50	0,9	
	2.0 16V	RFR (DEW10J4)	99/135	01.1999	10.2000	RFN 52 HZ3A (g)	A100		0,9	
	2.0 16V	RFN (EW10J4), RFV (EW10J4R)	100/136	10.2000	12.2004	RFN 52 HZ	A157	B50	0,9	
	2.0 16V	RFN (EW10J4), RFV (EW10J4R)	100/136	10.2000	12.2004	RFN 52 HZ3A (g)	A100		0,9	
	2.0 16V	RFV (XU10J4R)	97/132	11.1995	12.2004	RFC 42 LZ2E	A5	B30	0,9	F54
	2.2	3FZ (EW12J4)	116/158	03.2002	12.2004	RFN 52 HZ	A157	B50	0,9	
	2.2	3FZ (EW12J4)	116/158	03.2002	12.2004	RFN 52 HZ3A (g)	A100		0,9	
	3.0 24V	XFZ (ES9J4)	140/190	03.1997	12.2004	RFC 58 LZ 2	A54		1,0	F54
	3.0 V6	XFX (ES9J4S)	152/207	03.2000	12.2004	RFC 58 HZEDP5	A191		1,1	
407 (6D_)	1.8 i	6FZ (EW7J4)	85/115	05.2004		RFN 52 HZ	A157	B50	0,9	
	1.8 i	6FZ (EW7J4)	85/115	05.2004		RFN 52 HZ3A (g)	A100		0,9	
	1.8 i 16V	6FY (EW7A)	92/125	09.2005		RFN 52 HZ	A157	B50	0,9	
	1.8 i 16V	6FY (EW7A)	92/125	09.2005		RFN 52 HZ3A (g)	A100		0,9	
	2.0 i	RFN (EW10J4-L4)	100/136	05.2004		RFN 52 HZ	A157	B50	0,9	
	2.0 i	RFN (EW10J4-L4)	100/136	05.2004		RFN 52 HZ3A (g)	A100		0,9	
	2.0 i 16V	RFJ (EW10A)	103/140	09.2005		RFN 52 HZ	A157	B50	0,9	
	2.0 i 16V	RFJ (EW10A)	103/140	09.2005		RFN 52 HZ3A (g)	A100		0,9	
	2.0 i 16V BioFlex	RFJ (EW10A)	103/140	09.2007		RFN 52 HZ3A (g)	A100		0,9	
	2.2 i	3FZ (EW12J4)	116/158	05.2004		RFN 52 HZ	A157	B50	0,9	
	2.2 i	3FZ (EW12J4)	116/158	05.2004		RFN 52 HZ3A (g)	A100		0,9	
	2.2 i 16V	3FY (EW12J4)	120/163	09.2005		RFN 52 HZ	A157	B50	0,9	
	2.2 i 16V	3FY (EW12J4)	120/163	09.2005		RFN 52 HZ3A (g)	A100		0,9	
	3.0	XFV (ES9A)	155/211	05.2004		RFN 42 HZDP5	A184		1,1	
407 SW (6E_)	1.8 i	6FZ (EW7J4)	85/115	05.2004		RFN 52 HZ	A157	B50	0,9	
	1.8 i	6FZ (EW7J4)	85/115	05.2004		RFN 52 HZ3A (g)	A100		0,9	
	1.8 i 16V	6FY (EW7A)	92/125	09.2005		RFN 52 HZ	A157	B50	0,9	
	1.8 i 16V	6FY (EW7A)	92/125	09.2005		RFN 52 HZ3A (g)	A100		0,9	
	2.0 i	RFN (EW10J4-L4)	100/136	05.2004		RFN 52 HZ	A157	B50	0,9	
	2.0 i	RFN (EW10J4-L4)	100/136	05.2004		RFN 52 HZ3A (g)	A100		0,9	

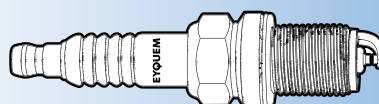

(1) Available until end of stock

- (a) 30 000 km
- (b) 60 000 km
- (c) Grey sticker on ignition coil
- (d) Green sticker on ignition coil

- (e) Hex 21 mm
- (f) Hex 16 mm
- (g) Recommended for cold weather



KW/HP



Box
10

Blister
4



F3-1

PEUGEOT

	2.0 i 16V	RFJ (EW10A)	103/140	09.2005		RFN 52 HZ3A (g)	A100		0,9	
	2.2 i	3FZ (EW12J4)	116/158	05.2004		RFN 52 HZ	A157	B50	0,9	
	2.2 i	3FZ (EW12J4)	116/158	05.2004		RFN 52 HZ3A (g)	A100		0,9	
	2.2 i 16V	3FY (EW12J4)	120/163	09.2005		RFN 52 HZ	A157	B50	0,9	
	2.2 i 16V	3FY (EW12J4)	120/163	09.2005		RFN 52 HZ3A (g)	A100		0,9	
	3.0	XFV (ES9A)	155/211	05.2004		RFN 42 HZDP5	A184		1,1	
407 Coupe (6C_)	2.2 i 16V	3FY (EW12J4)	120/163	10.2005		RFN 52 HZ	A157	B50	0,9	
	2.2 i 16V	3FY (EW12J4)	120/163	10.2005		RFN 52 HZ3A (g)	A100		0,9	
	3.0	XFV (ES9A)	155/211	10.2005		RFN 42 HZDP5	A184		1,1	
504	1.6 GR	XC7	46/63	10.1979	12.1990	C 52 LS	A1	B1	0,6	L65
	1.8 i L, GL, GR, SR	KF5 - KF6	58/79	01.1971	06.1983	C 82 LS	A40	B6	0,6	L87
	1.8 i	KF5 - KF6	71/97	07.1968	02.1971	C 82 LS	A40	B6	0,6	L87
	1.8 L, GL, GR, SR	XM	60/82	01.1971		C 52 LS	A1	B1	0,6	L65
	2.0 i L, GL, GR, SR, Ti	XN2		07.1968	10.1977	C 82 LS	A40	B6	0,6	L87
	2.0 i L, GL, GR, SR, Ti	XN2		10.1977	12.1990	C 52 LS	A1	B1	0,6	L65
	2.0 L, GL, GR, SR, Ti	XN1/A	71/97	01.1971	06.1986	C 52 LS	A1	B1	0,6	L65
504 (A_, M_)	1.8	XM7	55/75	09.1979	08.1982	C 52 LS	A1	B1	0,6	L65
	1.8	XM7	58/79	01.1971	06.1983	C 52 LS	A1	B1	0,6	L65
	1.8	XM	60/82	07.1968	02.1971	C 52 LS	A1	B1	0,6	L65
	1.8 Injection	KF5, KF6	71/97	07.1968	02.1971	C 82 LS	A40	B6	0,6	L87
	2.0	106 (XN1)	71/97	03.1971	06.1986	C 52 LS	A1	B1	0,6	L65
	2.0 TI	107 (XN2)	78/106	01.1971	10.1977	C 82 LS	A40	B6	0,6	L87
	2.0 TI	107 (XN2)	78/106	11.1977	06.1983	C 52 LS	A1	B1	0,6	L65
504 Break (D_, F_)	1.8	XM7	54/73	01.1971	07.1986	C 52 LS	A1	B1	0,6	L65
	2.0	XN1	68/92	04.1971	07.1986	C 52 LS	A1	B1	0,6	L65
	2.0	107 (XN2)	75/102	10.1974	10.1977	C 82 LS	A40	B6	0,6	L87
504 Coupé	2.0	107 (XN2)	75/102	11.1977	08.1982	C 52 LS	A1	B1	0,6	L65
	2.0	107 (XN2)	78/106	08.1982	08.1984	C 52 LS	A1	B1	0,6	L65
	2.7	140 (ZMJ)	106/144	10.1977	08.1984	C 62 LJS	A19	B2	0,6	J65
504 Cabriolet	2.0	107 (XN2)	75/102	10.1974	10.1977	C 82 LS	A40	B6	0,6	L87
	2.0	107 (XN2)	75/102	11.1977	08.1982	C 52 LS	A1	B1	0,6	L65
	2.0	107 (XN2)	78/106	08.1982	08.1984	C 52 LS	A1	B1	0,6	L65
504 Pick-up (E_)	1.6	XC7P	46/63	01.1980	06.1987	C 52 LS	A1	B1	0,6	L65
	1.8	XM7	54/73	07.1987	12.1989	C 52 LS	A1	B1	0,6	L65
	1.8	XM7	55/75	08.1981	10.1986	C 52 LS	A1	B1	0,6	L65
505 (551A)	1.8	105 (XM7)	55/75	06.1981	10.1985	C 52 LS	A1	B1	0,6	L65
	1.8	105 (XM7)	60/82	01.1982	10.1985	C 52 LS	A1	B1	0,6	L65
	1.8	105C (XM7A)	62/84	09.1985	10.1986	C 52 LS	A1	B1	0,6	L65
	2.0	XN1	69/94	09.1983	09.1985	C 52 LS	A1	B1	0,6	L65
	2.0	106 (XN1)	71/97	11.1980	12.1985	C 52 LS	A1	B1	0,6	L65
	2.0	106E (XN1A)	72/98	09.1985	09.1995	C 52 LS	A1	B1	0,6	L65
	2.0	XN1	79/107	09.1980	11.1982	C 52 LS	A1	B1	0,6	L65
	2.0 TI, STI	829 (ZEJ)	81/110	08.1979	10.1986	C 72 LJS	A22		0,6	J87
	2.2 i Turbo	N9T	110/150	10.1982	06.1988	C 82 LS	A40	B6	0,6	L87
	2.2 i Turbo	176B (N9TE)	114/155	03.1984	10.1988	C 62 LS3X	A13	B15	0,8	L65
	2.2 i Turbo	176W (N9TE)	128/174	06.1987	12.1988	C 82 LS	A40	B6	0,6	L87
	2.2	851X (ZDJL)	84/114	03.1986	12.1993	C 72 LJS	A22		0,6	J87
	2.2	851 (ZDJ)	85/115	05.1981	10.1984	C 72 LJS	A22		0,6	J87
	2.2 GTI	851B (ZDJL)	90/122	08.1983	12.1993	C 72 LJS	A22		0,6	J87
	2.2 GTI		96/131	08.1983	12.1993	C 72 LJS	A22		0,6	J87
	2.8 GTI V6	154X (ZN3J)	105/143	06.1986	12.1993	RC 72 LJS3	A80		1,2	
505 Break (551D)	1.8	XM7	55/75	04.1982	09.1985	C 52 LS	A1	B1	0,6	L65
	2.0		60/82	04.1982	11.1987	C 52 LS	A1	B1	0,6	L65
	2.0	106 (XN1)	69/94	08.1983	12.1985	C 52 LS	A1	B1	0,6	L65
	2.0	106E (XN1A)	72/98	09.1985	11.1987	C 52 LS	A1	B1	0,6	L65
	2.0	829 (ZEJ)	81/110	10.1985	09.1989	C 72 LJS	A22		0,6	J87
	2.0	851X (ZDJL)	84/114	01.1986	12.1993	C 72 LJS	A22		0,6	J87
	2.2 GTI	851B (ZDJL)	90/122	09.1985	12.1986	C 72 LJS	A22		0,6	J87
508	1.6	5GZ (EP6FDT)	120/163	01.2012		RXN 62 HSDP	A525		0,8	
	1.6 THP	EP6CDT	115/156	11.2010		RXN 62 HSDP	A525		0,7	
	1.6 VTi	5FH (EP6C)	85/115	11.2010		RXN 62 HSDP	A525		0,7	
	1.6 VTi	5FS (EP6C)	88/120	11.2010		RXN 62 HSDP	A525		0,7	
508 SW	1.6 VTi	5FH (EP6C)	85/115	11.2010		RXN 62 HSDP	A525		0,7	
	1.6 VTi	5FS (EP6C)	88/120	11.2010		RXN 62 HSDP	A525		0,7	
	1.6 THP	EP6CDT	115/156	11.2010		RXN 62 HSDP	A525		0,7	

(f) Available until end of stock

(a) 30 000 km

(b) 60 000 km

(c) Grey sticker on ignition coil

(d) Green sticker on ignition coil

(e) Hex 21 mm

(f) Hex 16 mm

(g) Recommended for

cold weather



EYQUEM



Box
10
Blister
4



F3

PEUGEOT

	1.6		121/165	02.2012		RXN 62 HSDP	A525		0.7	
5008	NEW 1.2	HNY (EB2DTS)	96/131	01.2015		RXN 72 HSIPFS	A541		0.75	
	1.6 16V	EP6, 5FS (EP6C), 5FW	88/120	09.2009		RXN 62 HSDP	A525		0.7	
	1.6 16V	EP6CDT	115/156	09.2009		RXN 62 HSDP	A525		0.7	
	1.6 THP 150		110/150	02.2012		RXN 62 HSDP	A525		0.7	
	1.6 THP 163	5GZ (EP6FDT)	120/163	02.2012		RXN 62 HSDP	A525		0.8	
	1.6 THP 165	5GZ (EP6FDT)	121/165	02.2012		RXN 62 HSDP	A525		0.8	
5008 II	NEW 1.2	HNY (EB2DTS)	96/131	12.2016		RXN 72 HSIPFS	A541		0.75	
604 (561A_)	2.0 i	XN6			12.1983	C 52 LS	A1	B1	0,6	L65
	2.7 i V6 SL, STi, Ti	112 (ZM, ZMJ)	100/136	08.1975	06.1985	C 62 LJS	A19	B2	0,6	J65
	2.7 i V6 SL, STi, Ti	140 (ZMJ)	106/144	08.1977	05.1983	C 62 LJS	A19	B2	0,6	J65
	2.8 i V6 GTi, Ti	154A (ZNJ, ZMJ-K)	110/150	10.1982	07.1987	C 62 LJS	A19	B2	0,6	J65
605 (6B)	2.0 SL, SR	XU10.2C [R2A] [R5A]	85/115	10.1989		RFN 58 LZ (b)	A7	B28	0,9	F54
	2.0 SRI	XU10J2C	79/107	02.1990	09.1999	RFC 42 LZ2E	A5	B30	0,9	F54
	2.0 i	XU10 M-Z [RDZ]	81/110	06.1989		RFN 58 LZ (b)	A7	B28	0,9	F54
	2.0	RFZ (XU10J2Z)	89/121	06.1989	09.1999	RFN 58 LZ (b)	A7	B28	0,9	F54
	2.0 i	XU10 J2 [RFX] [R6D] [RFZ] [R6A]	89/121	06.1989		RFN 58 LZ (b)	A7	B28	0,9	F54
	2.0 16V	RFV (XU10J4R)	97/132	07.1994	09.1999	RFC 42 LZ2E	A5	B30	0,9	F54
	2.0 16V SLi, Sri, Auto	XU10J4R	97/132	07.1994	09.1999	RFC 42 LZ2E	A5	B30	0,9	F54
	2.0 Turbo	RGY (XU10J2TE)	104/141	07.1992	09.1999	RFC 58 LZ2E	A10	B31	0,9	F54
	2.0 i Turbo	RGX (XU10J2TE)	107/145	07.1991	09.1999	RFC 58 LZ2E	A10	B31	0,9	F54
	2.0 Turbo	RGX (XU10J2TE)	108/147	07.1991	09.1999	RFC 58 LZ2E	A10	B31	0,9	F54
	3.0 i V6	UFZ (ZPJ), UFY, S6A, SFY	123/167	08.1989	09.1999	RFC 58 LS3	A16	B33	1,2	
	3.0 V6	XFZ (ES9J4)	140/190	09.1997	09.1999	RFC 58 LZ 2	A54		1,0	F54
	3.0 i V6 24V	XFZ (ES9J4-L3)	143/194	12.1996	05.1999	RFC 58 LZ 2	A54		1,0	F54
	3.0 i V6 24V	UKZ (ZPJ4/Z), SKZ, UKY	147/200	08.1989	09.1999	RFC 58 LS3	A16	B33	1,2	
607 (9D, 9U)	2.0 i 16V	RFN (EW10J4-L4)	100/136	10.1999		RFN 52 HZ	A157	B50	0,9	
	2.0 i 16V	RFN (EW10J4-L4)	100/136	10.1999		RFN 52 HZ3A (g)	A100		0,9	
	2.2 i 16V	3FZ (EW12J4)	116/158	10.1999		RFN 52 HZ	A157	B50	0,9	
	2.2 i 16V	3FZ (EW12J4)	116/158	10.1999		RFN 52 HZ3A (g)	A100		0,9	
	2.2 i 16V	EW12 J4	120/163	09.2005		RFN 52 HZ	A157	B50	0,9	
	2.2 i 16V	EW12 J4	120/163	09.2005		RFN 52 HZ3A (g)	A100		0,9	
	3.0 V6 24V	XFZ (ES9J4S)	152/207	02.2000		RFN 42 HZDP5	A184		1,1	
	3.0 V6 24V	XFV (ES9A)	155/211	03.2004		RFN 42 HZDP5	A184		1,1	
806 (221)	1.8 SL, SR, ST	LFW (XU7JP)	73/99	07.1995	08.2002	RFC 42 LZ2E	A5	B30	0,9	F54
	2.0	RFU (XU10J2C)	89/121	06.1994	08.2002	RFC 42 LZ2E	A5	B30	0,9	F54
	2.0 16V	RFV (XU10J4R)	97/132	05.1998	09.2000	RFN 58 LZ (b)	A7	B28	0,9	F54
	2.0 16V	RFV (XU10J4R)	97/132	05.1998	09.2000	RFN 58 LZ3A (g)	A515		0,9	
	2.0 i 16V	RFN (EW10J4-L4)	100/136	05.2000	08.2002	RFN 52 HZ	A157	B50	0,9	
	2.0 i 16V	RFN (EW10J4-L4)	100/136	05.2000	08.2002	RFN 52 HZ3A (g)	A100		0,9	
	2.0 Turbo	RGX (XU10J2TE)	108/147	06.1994	08.2002	RFC 58 LZ2E	A10	B31	0,9	F54
807 (E)	2.0 i 16V	RFN (EW10J4-L4)	100/136	06.2002		RFN 52 HZ	A157	B50	0,9	
	2.0 i 16V	RFN (EW10J4-L4)	100/136	06.2002		RFN 52 HZ3A (g)	A100		0,9	
	2.0 i 16V	RFJ (EW10J4-L4)	103/140	09.2005		RFN 52 HZ	A157	B50	0,9	
	2.0 i 16V	RFJ (EW10J4-L4)	103/140	09.2005		RFN 52 HZ3A (g)	A100		0,9	
	2.2 i 16V	3FZ (EW12J4)	116/158	04.2002		RFN 52 HZ	A157	B50	0,9	
	2.2 i 16V	3FZ (EW12J4)	116/158	04.2002		RFN 52 HZ3A (g)	A100		0,9	
	3.0 V6	XFZ (ES9J4S)	150/204	06.2002		RFN 42 HZDP5	A184		1,1	
1007 (KM_)	1.4 i 16V	KFU (ET3J4)	65/88	04.2005		RWC 52 HSK	A197	B58	0,9	
	1.4 i 8V	TU3A	54/73	04.2005		RFN 58 LZ (b)	A7	B28	0,9	F54
	1.4 i 8V	TU3A	54/73	04.2005		RFN 58 LZ3A (g)	A515		0,9	
	1.6 i 16V	NFU (TU5JP4)	80/109	04.2005		RFN 58 HZ	A158		0,9	
	1.6 i 16V	NFU (TU5JP4)	80/109	04.2005		RFN 58 HZ3A (g)	A516		0,9	
RCZ	1.6 16V	EP6CDT	115/156	03.2010		RXN 62 HSDP	A525		0.7	
BIPPER (AA_)	1.4	KFV (TU3A)	54/73	02.2008		RFN 58 LZ (b)	A7	B28	0,9	F54
	1.4	KFV (TU3A)	54/73	02.2008		RFN 58 LZ3A (g)	A515		0,9	
BIPPER Tepee	1.4	KFV (TU3A)	54/73	04.2008		RFN 58 LZ (b)	A7	B28	0,9	F54
	1.4	KFV (TU3A)	54/73	04.2008		RFN 58 LZ3A (g)	A515		0,9	
BOXER Bus (230P)	2.0 i	RFW (XU10J2)	80/109	03.1994	04.2002	RFN 58 LZ (b)	A7	B28	0,9	F54
	2.0 i	RFW (XU10J2)	80/109	03.1994	04.2002	RFN 58 LZ3A (g)	A515		0,9	
BOXER Box (230L)	2.0 i	RFW (XU10J2)	80/109	06.1994	04.2002	RFN 58 LZ (b)	A7	B28	0,9	F54
	2.0 i	RFW (XU10J2)	80/109	06.1994	04.2002	RFN 58 LZ3A (g)	A515		0,9	
BOXER Box (244)	2.0 i	RFL (XU10J2U)	81/110	04.2002		RFC 58 LZ 2	A54		1,0	F54

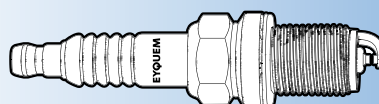

(1) Available until end of stock

- (a) 30 000 km
- (b) 60 000 km
- (c) Grey sticker on ignition coil
- (d) Green sticker on ignition coil

- (e) Hex 21 mm
- (f) Hex 16 mm
- (g) Recommended for cold weather



Box
10

Blister
4



F3→1

PEUGEOT

BOXER Platform/ Chassis (ZCT_)	2.0 i	RFW (XU10J2)	80/109	06.1994	04.2002	RFN 58 LZ (b)	A7	B28	0,9	F54
	2.0 i	RFW (XU10J2)	80/109	06.1994	04.2002	RFN 58 LZ3A (g)	A515		0,9	
	2.0	RFL (XU10J2U)	81/110	12.2001	04.2002	RFC 58 LZ 2	A54		1,0	F54
BOXER Bus (244, Z_)	2.0	RFL (XU10J2U)	81/110	04.2002		RFC 58 LZ 2	A54		1,0	F54
EXPERT (224)	1.6	222A2 (1580 SPI)	58/79	02.1996		RFN 62 LZ	A71		0,8	F86
	1.6 i	1580 SPI	58/79	10.1995		RFN 62 LZ	A71		0,8	F86
	1.8 i	XU7 JP [L6B]	68/92	10.1995		RFN 58 LZ (b)	A7	B28	0,9	F54
	1.8 i	XU7 JP [L6B]	68/92	10.1995		RFN 58 LZ3A (g)	A515		0,9	
	1.8	LFZ (XU7JP)	74/101	10.1996	09.2000	RFC 42 LZ2E	A5	B30	0,9	F54
	2.0 i 16V	RFN (EW10J4-L4)	100/136	05.1999		RFN 52 HZ	A157	B50	0,9	
	2.0 i 16V	RFN (EW10J4-L4)	100/136	05.1999		RFN 52 HZ3A (g)	A100		0,9	
EXPERT Box (222)	1.6	222A2 (1580 SPI)	58/79	02.1996		RFN 62 LZ	A71		0,8	F86
	1.8	LFZ (XU7JP)	74/101	10.1996	09.2000	RFC 42 LZ2E	A5	B30	0,9	F54
	2.0 i 16V	RFN (EW10J4-L4)	100/136	05.1999		RFN 52 HZ	A157	B50	0,9	
	2.0 i 16V	RFN (EW10J4-L4)	100/136	05.1999		RFN 52 HZ3A (g)	A100		0,9	
EXPERT Box (VF3A_ VF3U_, VF3X_)		RFJ, RFH (EW10A)	103/140	01.2007		RFN 52 HZ3A (g)	A100		0,9	
EXPERT Platform/ Chassis (223)	1.6	222A2 (1580 SPI)	58/79	02.1996		RFN 62 LZ	A71		0,8	F86
EXPERT Tepee (VF3V_)	2.0 i 16V	RFJ, RFH (EW10A)	103/140	01.2007		RFN 52 HZ3A (g)	A100		0,9	
J5 (280L)	1.8	169B (X7MT)	51/69	01.1983	11.1988	C 52 LS	A1	B1	0,6	L65
	2.0	XN1P	58/79	09.1981	08.1990	C 52 LS	A1	B1	0,6	L65
J5 Box (290L)	1.8	169B (X7MT)	51/69	09.1990	01.1994	C 52 LS	A1	B1	0,6	L65
J5 Bus (280P)	2.0	170B (XN1T)	55/75	09.1981	09.1990	C 52 LS	A1	B1	0,6	L65
	2.0	170B (XN1T)	58/79	01.1983	09.1990	C 52 LS	A1	B1	0,6	L65
J5 Bus (290P)	2.0	170D (XN1TACP)	62/84	10.1990	02.1994	C 52 LS	A1	B1	0,6	L65
J5 Platform/ Chassis (280L)	2.0	170B (XN1T)	55/75	01.1986	11.1988	C 52 LS	A1	B1	0,6	L65
	2.0	170 (XN1T)	58/79	01.1983	11.1988	C 52 LS	A1	B1	0,6	L65
J5 Platform/ Chassis (290L)	2.0	170D (XN1TACP)	62/84	10.1990	02.1994	C 52 LS	A1	B1	0,6	L65
J7 Box	1.5	XB5P	61/83	08.1968	07.1970	C 52 LS	A1	B1	0,6	L65
	1.6	XC7P	44/60	08.1968	03.1980	C 52 LS	A1	B1	0,6	L65
	1.6	XC5P	50/68	08.1968	03.1980	C 52 LS	A1	B1	0,6	L65
J7 Bus	1.6	XC7P	44/60	07.1970	03.1980	C 52 LS	A1	B1	0,6	L65
	1.6	XC5P	50/68	08.1968	07.1970	C 52 LS	A1	B1	0,6	L65
	1.8	XM7P	48/65	07.1970	03.1980	C 52 LS	A1	B1	0,6	L65
J7 Platform/Chassis	1.6	XC7P	44/60	07.1970	03.1980	C 52 LS	A1	B1	0,6	L65
	1.6	XC5P	50/68	08.1968	07.1970	C 52 LS	A1	B1	0,6	L65
	1.8	XM7P	48/65	07.1970	03.1980	C 52 LS	A1	B1	0,6	L65
J9 Box	1.6	XC7P	44/60	03.1980	06.1987	C 52 LS	A1	B1	0,6	L65
	2.0	XN1P	57/78	03.1980	06.1987	C 52 LS	A1	B1	0,6	L65
J9 Bus	2.0	XN1P	57/78	03.1980	06.1987	C 52 LS	A1	B1	0,6	L65
J9 Platform/Chassis	1.6	XC7P				C 52 LS	A1	B1	0,6	L65
P4		XN8				C 52 LS	A1	B1	0,7	L65
PARTNER Combispace (5F)	1.1	HDZ (TU1M), HFX (TU1JP)	44/60	06.1996		RFC 58 LZ 2	A54		1,0	F54
	1.1 i	HFZ, HFY (TU1JP-L3)	44/60	05.2000		RFC 58 LZ 2	A54		1,0	F54
	1.4	KFW (TU3JP), KFX (TU3JP)	55/75	06.1996		RFC 58 LZ 2	A54		1,0	F54
	1.4	KFW (TU3JP)	54/73	11.2002	10.2006	RFC 58 LZ 2	A54		1,0	F54
	1.4 i	KFX (TU3JP), KFW (TU3JP), TU3.2	55/75	06.1996		RFC 58 LZ 2	A54		1,0	F54
	1.6 i 16V	NFU (TU5 JP4-L4)	80/109	10.2000		RFN 58 HZ	A158		0,9	
	1.6 i 16V	NFU (TU5 JP4-L4)	80/109	10.2000		RFN 58 HZ3A (g)	A516		0,9	
	1.8	LFX (XU7JB)	66/90	05.1997		RFC 58 LZ 2	A54		1,0	F54
PARTNER Box	1.6 i 16V	NFR (TU5JP4B)	66/90	04.2008		RFN 58 HZ	A158		0,9	
	1.6 i 16V	NFR (TU5JP4B)	66/90	04.2008		RFN 58 HZ3A (g)	A516		0,9	
	1.6 i 16V	NFU (TU5JP4)	80/109	04.2008		RFN 58 HZ	A158		0,9	
	1.6 i 16V	NFU (TU5JP4)	80/109	04.2008		RFN 58 HZ3A (g)	A516		0,9	
	1.6 i 16V	5FK (EP6CB)	72/98	08.2010		RXN 62 HSDP	A525		0,7	
	1.6 i 16V	5FS (EP6C)	88/120	04.2010		RXN 62 HSDP	A525		0,7	
PARTNER Box (5)	1.1	HDZ (TU1M)	44/60	06.1996		RFC 58 LZ 2	A54		1,0	F54
	1.4	KFV (TU3A)	54/73	11.2002	10.2006	RFC 58 LZ 2	A54		1,0	F54
	1.4	KFX (TU3JP), TU3.2	55/75	06.1996		RFC 58 LZ 2	A54		1,0	F54

(1) Available until end of stock

(a) 30 000 km

(b) 60 000 km

(c) Grey sticker on ignition coil

(d) Green sticker on ignition coil

(e) Hex 21 mm

(f) Hex 16 mm

(g) Recommended for

cold weather



EYQUEM



Box
10

Blister
4



F3-1

PEUGEOT

	1.4 BiFuel	KFW (TU3JP)	55/75	04.2003		RFN 58 LZ3A (g)	A515		0,9	F54
	1.6 i 16V	NFU (TU5 JP4-L4)	80/109	09.2000	10.2002	RFN 58 HZ	A158		0,9	
	1.6 i 16V	NFU (TU5 JP4-L4)	80/109	09.2000	10.2002	RFN 58 HZ3A (g)	A516		0,9	
PARTNER Tepee	1.6 16V	NFR (TU5JP4B)	66/90	04.2008		RFN 58 HZ	A158		0,9	
	1.6 16V	NFR (TU5JP4B)	66/90	04.2008		RFN 58 HZ3A (g)	A516		0,9	
	1.6 16V	NFU (TU5JP4)	80/109	04.2008		RFN 58 HZ	A158		0,9	
	1.6 16V	NFU (TU5JP4)	80/109	04.2008		RFN 58 HZ3A (g)	A516		0,9	
	1.6 16V	5FK (EP6CB)	72/98	08.2010		RXN 62 HSDP	A525		0,7	
	1.6 16V	5FS (EP6C)	88/120	04.2010		RXN 62 HSDP	A525		0,7	

PIAGGIO

APECAR, VESPACAR	0.05 50FL2, P50					C 62	A20		0,5	
	0.05 TM P50					C 72	A64		0,5	
	0.2 Car P2, Car P3, 601V, 703TM					C 72	A64		0,5	
	0.2 P401, P500V, P501, P601					C 72	A64		0,5	
	0.2 P601V, P602TM, TM P703M, V					C 72	A64		0,5	
	0.4 Poker Quadrificio					C 82 LS3X	A92		0,8	L87
	400 : 0.4 MP					C 72	A64		0,5	
	500 : 0.5 MP					C 72	A64		0,5	
	600 : 0.6 MPV					C 72	A64		0,5	
	Ciao Porter					C 62	A20		0,5	
MINIVAN	1.0 Porter			12.1992		RC 52 LS	A9	B20	0,8	L65

PGO

CEVENNES	1.6	N 14 B16 A	135/184	01.2006		RXN 62 HSDP	A525		0,7	
HAMERA	1.6	N 14 B16 A	135/184	05.2008		RXN 62 HSDP	A525		0,7	
SPEEDSTER	1.6	N 14 B16 A	135/184	01.2010		RXN 62 HSDP	A525		0,7	

PLYMOUTH

ACCLAIM	3.0 i V6 LX	(3)	104/141	01.1989	08.1995	RC 32 LS5	A110		1,1	
BREEZE	2.0 i 16V		98/133	08.1995		RFC 42 LS5	A83		1,1	F54-5
FURY	5.2 V8			01.1986	12.1989	RC 30 LS	A109		0,9	
LASER	1.8	4G37	68/92	09.1989		RC 52 LS5	A36	B38	1,1	L65-5
	2.0 Turbo	4G63	110-146/150-199	09.1989		RC 52 LS5	A36	B38	1,1	L65-5
PROWLER	3.5 i	(F)	157/214	08.1996		RFC 42 LS5	A83		1,1	F54-5
SUNDANCE	2.2 i			01.1987		RC 30 LS	A109		0,9	
	2.5 i		74/101	01.1988		RC 30 LS	A109		0,9	
	3.0 i V6	(3)	105/143	01.1993		RC 32 LS5	A110		1,1	
VOYAGER	2.2	(C)		01.1986	12.1987	RC 30 LS	A109		0,9	
	2.5 i		74/101	01.1987		RC 30 LS	A109		0,9	
	2.6	(G)		01.1986	12.1987	RC 30 LS	A109		0,9	
	3.0 i V6	(3)	105/143	01.1987		RC 32 LS5	A110		1,1	

PONTIAC

GRAND AM	2.0 i Turbo	(M)	123/167	09.1986	08.1989	RC 62 LS	A6	B17	0,8	L65
	2.3		90/122	08.1991		RFC 42 LS	A25		0,9	F54
	2.3 16V	(D) [DOHC]	119/162	08.1991		RFC 42 LS	A25		0,9	F54
	2.3 16V GT	(D) [DOHC]	134/182	08.1991		RFC 42 LS	A25		0,9	F54
SUNBIRD	1.8 i Turbo	(J)		01.1984	12.1986	RC 62 LS	A6	B17	0,8	L65
	2.0 i Turbo	(M)		01.1988	12.1990	RC 30 LS	A109		0,8	
TRANS SPORT	2.3 i 16V	[DOHC]	101/137	08.1991		RFC 42 LS5	A83		1,1	F54-5

PORSCHE

911	3.2 Carrera	930.20 - 930.26	170/231	08.1983	08.1989	RC 82 L	A94		0,7	
	3.2 Carrera	930.21 - 930.25	152-160/207-218	09.1983	08.1989	RC 62 LS	A6	B17	0,7	L65
924	2.0 i	XG - XJ - XK	85-92/115-125	01.1976	08.1985	C 82 LS	A40	B6	0,7	L87
	2.5 i S	M44.07 - 08 - 09 - 10	110/150	09.1985	07.1988	RC 62 LS	A6	B17	0,8	L65
928	4.5		177/241	05.1977	07.1982	RC 52 LS	A9	B20	0,7	L65
	4.7 S	M28.11 - 12 - 21 - 22	228/310	08.1983	07.1986	RC 62 LS	A6	B17	0,7	L65
	5.0 CS, GT, S4	M28.41 - 42 - 47	235-243/320-330	08.1986	07.1991	RC 62 LS	A6	B17	0,7	L65
	5.0 S	M28.43 - 44 - 45 - 46	200-212/272-288	12.1984	07.1986	RC 62 LS	A6	B17	0,7	L65
	5.4 i V8 32V GTS	M28.49 - 50	257/350	08.1991	11.1995	RC 62 LS	A6	B17	0,7	L65
944	2.5	M44.01 - 03	120/163	07.1981	12.1984	RC 62 LS	A6	B17	0,7	L65
	2.5	M44.05 - 06 - 09 - 10	118-120/160-163	01.1985	07.1988	RC 62 LS	A6	B17	0,7	L65
	2.5 i	M44.07 - 08	110/150	01.1985	07.1987	RC 62 LS	A6	B17	0,7	L65

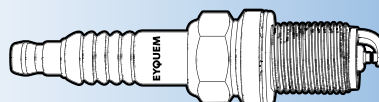

(1) Available until end of stock

- (a) 30 000 km
- (b) 60 000 km
- (c) Grey sticker on ignition coil
- (d) Green sticker on ignition coil

- (e) Hex 21 mm
- (f) Hex 16 mm
- (g) Recommended for cold weather



Box
10

Blister
4



F3 → 1

PORSCHE

	2.5 S	M44.40	135-140/184-190	08.1986	07.1988	RC 72 LS	A32	B26	0,7	L87
	2.5 Turbo	M44.50 - 51 - 52	162/220	08.1985	07.1991	RC 62 LS	A6	B17	0,7	L65
	2.7	M44.11 - 12	121/165	11.1988	08.1989	RC 62 LS	A6	B17	0,7	L65
	3.0 S2	M44.41	153-155/208-211	12.1988	07.1991	RC 82 LS	A78		0,7	L87
968	3.0 i 16V CS	M44.43 - 44	176/239	08.1991	11.1995	C 72 LS3X	A63		0,8	L87
	3.0 Turbo S		224/305	08.1991	11.1995	RFC 58 LS	A18		0,7	F54
	3.0 Turbo S		224/305	03.1993	11.1995	RFN 52 LZ	A27		0,9	F54
BOXSTER	2.5	M 96.20	150/204	09.1996	08.1999	RFC 58 LZK (a)	A11	B29	0,8	F54
	2.5 i L6 24V	M96.20	150/204	09.1996		RFC 58 LZ2E	A10	B31	0,9	F54
CAYENNE (9PA)	Turbo S 4.5	M48.50S	368/500	01.2004	09.2007	FN 58 LZDPR	A198		0,75	
	Turbo S 4.5	M48.50T	383/521	03.2006	09.2007	FN 58 LZDPR	A198		0,75	

PREMIER

PREMIER	118 : 1.2 NE	A12		10.1986		RC 52 LS	A9	B20	0,8	L65
---------	--------------	-----	--	---------	--	----------	----	-----	-----	-----

PROTON

PERSONA	1.3 i 12V	4G13 B	55/75	01.1993		RC 62 LS5	A24		1,1	L65-5
	1.5 i	4G15	66/90	01.1993		RC 62 LS5	A24		1,1	L65-5
	1.6 i 16V	4G92 [DOHC] Cat	83/113	01.1993		RFC 52 LS5	A26	B24	1,1	F54-5
	1.8 i	4G93 [SOHC] Cat	85/115	12.1995		RFC 58 LS5	A38	B48	1,1	F54-5
PERSONA 300	300 : 1.3 i	4G13 B	55/75	03.1996		RC 62 LS	A6	B17	1,0	L65
	300 : 1.5 i	G15B	64-66/87-90	03.1996		RC 62 LS	A6	B17	1,0	L65
PERSONA 400	400 : 1.3 i GLSi	4G13 B	55/75	01.1996		RC 52 LS5	A36	B38	1,1	L65-5
	400 : 1.5 i GLi, GLSi	4G15 Cat	66/90	11.1994		RC 52 LS5	A36	B38	1,1	L65-5
	400 : 1.6 i 16V GLXi	4G92 [DOHC] Cat	83/113	11.1994		RFC 52 LS5	A26	B24	1,1	F54-5
	400 : 1.8 i	4G93 [SOHC] Cat	83-85/113-115	12.1995		RFC 58 LS5	A38	B48	1,1	F54-5
SALOON	1.3 i	G13B	55/75	01.1989		RC 62 LS	A6	B17	1,0	L65
	1.3 i Saloon	G13B Cat	55/75	01.1993		RC 62 LS5	A24		1,1	L65-5
	1.5 i	G15B	66/90	01.1989		RC 62 LS	A6	B17	1,0	L65
	1.5 i Saloon	G15B	66/90	01.1993		RC 62 LS5	A24		1,1	L65-5
SATRIA	1.3 i 12V GL	4G13 [SOHC] Cat	55/75	02.1995		C 52 LS	A1	B1	1,0	L65
TIARA	1.1	TU1-K [H1A]	44/60	05.1996		FC 52 LS	A2	B9	0,9	F54

PUCH

G-MODELL (W 463)	G 320	M 104.996	155/211	09.1994	06.1997	FC 42 LS	A15	B14	0,8	F54
------------------	-------	-----------	---------	---------	---------	----------	-----	-----	-----	-----

RELIANT

ANADOL						RC 62 LS	A6	B17	0,8	L65
KITTEN	0.8			01.1974	12.1984	RC 30 LS	A109		0,8	
SCIMITAR	1.3 SS1		41/56	09.1984		RFC 58 LS	A18		0,8	F54
	1.4 SS1		53/72	09.1984	01.1990	RFC 58 LS	A18		0,8	F54
	1.6 SS1		70/95	10.1984	01.1990	RFC 58 LS	A18		0,8	F54
	1.8 i Turbo SS1	CA18ET	90-100/122-136	03.1986	11.1992	RFC 58 LS5	A38	B48	1,1	F54-5
	2.8 i V6 Break		100/136	10.1975	09.1990	RC 72 LS	A32	B26	0,8	L87
	2.8 i V6 Cabriolet		100/136	10.1975	09.1990	RC 72 LS	A32	B26	0,8	L87
	3.0	3012E	101/137	01.1965	12.1979	RC 62 LS	A6	B17	0,8	L65
SCIMITAR SABRE	1.4 i 16V	K 16 series [DOHC]	76/103	10.1993		RFN 58 LZ (b)	A7	B28	0,8	F54
	1.4 i 16V	K 16 series [DOHC]	76/103	10.1993		RFN 58 LZ3A (g)	A515		0,8	
	1.8 i Turbo	CA18ET	99/135	10.1993		RFC 58 LS5	A38	B48	1,1	F54-5
	2.0 i 16V	T16 [DOHC]	99/135	01.1994		RFC 58 LS	A18		0,8	F54
TW9 PICK-UP	TW9 Pick-up			01.1975		RC 62 LS	A6	B17	0,8	L65

RENAULT

4 (112)	0.7	680.702	15/20	04.1962	04.1971	C 32 S	A8	B3	0,6	N43
	0.8	800-800 705	19/26	10.1962	09.1983	C 32 S	A8	B3	0,6	N43
	0.8	839.706	20/27	01.1981	09.1982	C 32 S	A8	B3	0,6	N43
	0.8	800 705 - B1B 707	21/29	10.1983	10.1988	C 32 S	A8	B3	0,6	N43
	0.8 i	680 - 800			12.1993	C 32 S	A8	B3	0,6	N43
	0.8	800 01	25/34	09.1971	12.1988	C 32 S	A8	B3	0,6	N43
	1.0	C1C 708	25/34	06.1987	06.1993	C 32 S	A8	B3	0,6	N43
	1.1	688 712- C1E 714-719	25/34	06.1978	12.1993	C 32 S	A8	B3	0,6	N43
	1.1	C1E 714	32/44	06.1986	06.1990	C 32 S	A8	B3	0,6	N43
	1.1	688 712	33/45	02.1978	03.1984	C 32 S	A8	B3	0,6	N43
4F4 / 4F6 (R21,R23_)	0.8	839 706	19/26	09.1971	08.1982	C 32 S	A8	B3	0,6	N43
	0.8	800 705- B1B 707	21/29	04.1983	07.1989	C 32 S	A8	B3	0,6	N43

(1) Available until end of stock

(a) 30 000 km

(b) 60 000 km

(c) Grey sticker on ignition coil

(d) Green sticker on ignition coil

(e) Hex 21 mm

(f) Hex 16 mm

(g) Recommended for

cold weather



EYQUEM



Box 10
Blister 4



F3 → 1

RENAULT

	0.8	800 01	25/34	09.1966	12.1988	C 32 S	A8	B3	0,6	N43
	1.0	C1C 708	25/34	06.1987	12.1993	C 32 S	A8	B3	0,6	N43
	1.1	688 711	25/34	10.1976	07.1989	C 42 S	A12	B7	0,6	N43
	1.1	688 712- C1E 714-718-719	25/34	10.1976	07.1989	C 32 S	A8	B3	0,6	N43
	1.1	C1E 718-719	26/35	07.1982	07.1989	C 32 S	A8	B3	0,6	N43
5 (122_)	0.8	800 710	26/35	10.1972	08.1984	C 32 S	A8	B3	0,6	N43
	0.8	800 710	27/37	01.1982	12.1984	C 32 S	A8	B3	0,6	N43
	0.8	839 701	27/37	10.1972	09.1984	C 32 S	A8	B3	0,6	N43
	1.0	689 710	32/44	10.1972	12.1985	C 42 S	A12	B7	0,6	N43
	1.1	C1E 726-688 713	33/45	10.1979	03.1985	C 32 S	A8	B3	0,6	N43
	1.3	810 726	31/42	09.1976	09.1979	C 32 S	A8	B3	0,6	N43
	1.3	810 719	33/45	04.1974	09.1984	C 52 LS	A1	B1	0,6	L65
	1.3 Automatic	810 729	40/54	06.1979	09.1984	C 42 S	A12	B7	0,6	N43
	1.3	810 725	47/64	09.1975	09.1984	C 42 S	A12	B7	0,6	N43
	1.4	847 712	43/58	06.1982	07.1984	RC 52 LS	A9	B20	0,6	L65
	1.4	847 725-729	46/63	09.1979	09.1984	RC 32 LS	A49	B19	0,7	L3
	1.4	C2J 713	46/63	06.1982	07.1984	RC 62 LS	A6	B17	0,8	L65
	1.4 Alpine, Gordini	840 725	68/92	03.1976	09.1981	C 62 LJS	A19	B2	0,6	J65
	1.4 Alpine Turbo	C6J 726-728-750 - 840 726	79/107	09.1981	01.1985	883 LJP	A87		0,6	
	1.4 Turbo	C6J 750	81/110	06.1984	01.1985	883 LJP	A87		0,6	
	1.4 Turbo	840 730	118/160	06.1980	01.1985	883 LJP	A87		0,6	
	1.4 Turbo 2	840 730	118/160	09.1980	03.1985	883 LJP	A87		0,6	
5 société (238_)	0.8	800 710	26/35	10.1972	08.1984	C 32 S	A8	B3	0,6	N43
	1.0	689 710	32/44	01.1972	12.1985	C 42 S	A12	B7	0,6	N43
	1.1	C1E 726-688 713- C1E 750-752-754	33/45	09.1980	12.1985	C 32 S	A8	B3	0,6	N43
	1.3	810 726	32/44	03.1976	08.1982	C 32 S	A8	B3	0,6	N43
6 (118_)	0.8	800.02	25/34	10.1969	04.1980	C 32 S	A8	B3	0,6	N43
	0.8	800 702-703-705				C 32 S	A8	B3	0,6	N43
	1.1	688 710	33/45	07.1971	04.1980	C 42 S	A12	B7	0,6	N43
	1.1	688 10	35/48	07.1971	04.1980	C 42 S	A12	B7	0,6	N43
7 (124_)	1.0	688.710	37/50	03.1975	12.1982	C 42 S	A12	B7	0,6	N43
8 (113_)	1.0	689 70	29/39	11.1962	10.1972	C 42 S	A12	B7	0,6	N43
	1.1 S, Major	688 01	33/45	11.1962	10.1972	C 42 S	A12	B7	0,6	N43
9 (L42_)	1.1	C1E 715-720	34/46	09.1981	05.1987	C 52 LS	A1	B1	0,8	L65
	1.2	C1G 700-710	40/54	09.1985	12.1988	C 52 LS	A1	B1	0,8	L65
	1.4		44/60	06.1987	04.1989	C 52 LS	A1	B1	0,8	L65
	1.4	C1J 715-730-792-796	44/60	12.1981	12.1988	C 52 LS	A1	B1	0,8	L65
	1.4	C2J 766-767-768-720	49/67	09.1985	12.1988	C 52 LS	A1	B1	0,8	L65
	1.4	C1J - C2J	49-53/67-72	09.1981	03.1991	RC 52 LS	A9	B20	0,8	L65
	1.4 Automatic	C2J 718-757	50/68	09.1981	12.1985	C 52 LS	A1	B1	0,8	L65
	1.4	C2J 717-755	53/72	09.1981	12.1985	C 52 LS	A1	B1	0,8	L65
	1.4 i	C3J 700-756	43/58	06.1987	03.1991	RC 32 LS	A49	B19	0,8	L3
	1.4 Turbo	C1J 760-764-770-782	77/105	09.1983	03.1991	805 LP	A79		0,65	
	1.4 Turbo	C1J 760-764	85/115	12.1986	12.1989	805 LP	A79		0,65	
	1.7 i	F3N 718	54/73	10.1983	03.1991	RC 62 LS	A6	B17	0,8	L65
	1.7 i	F2N 730	55/75	10.1986	12.1988	C 82 LS	A40	B6	0,8	L87
	1.7 i	F2N 712-742	55-64/75-87	10.1983	03.1991	C 82 LS	A40	B6	0,8	L87
	1.7 i	F2N 700-704-730	59/80	10.1983	03.1991	C 82 LS	A40	B6	0,8	L87
	1.7 i	F3N 708-710-798	65-70/88-98	10.1983	03.1991	C 82 LS	A40	B6	0,8	L87
	1.7 i	F3N 708	69/94	06.1987	12.1988	C 82 LS	A40	B6	0,8	L87
10 (119_)	1.1	688.01	33/45	05.1966	10.1972	C 42 S	A12	B7	0,6	N43
	1.3	810.03	35/48	07.1969	10.1972	C 42 S	A12	B7	0,6	N43
11 (B/C37_)	1.1	C1E 715-720	35/48	09.1981	03.1991	RC 52 LS	A9	B20	0,8	L65
	1.2	C1G 700-710	40/54	10.1984	03.1991	RC 52 LS	A9	B20	0,8	L65
	1.4	C1J -C2J	46-53/63-72	09.1981	03.1991	RC 52 LS	A9	B20	0,8	L65
	1.4	C1J 715-C2J 730	44/60	03.1983	12.1988	RC 52 LS	A9	B20	0,8	L65
	1.4	C3J 700-756	43/58	06.1987	03.1991	RC 32 LS	A49	B19	0,8	L3
	1.4	C2J 720-766-767-768	49/67	03.1983	12.1988	RC 52 LS	A9	B20	0,8	L65
	1.4	C2J 718-757	50/68	03.1983	12.1985	RC 52 LS	A9	B20	0,8	L65
	1.4	C2J 717-755	53/72	05.1983	12.1985	RC 52 LS	A9	B20	0,8	L65
	1.4 Turbo	C1J 760-764	77/105	09.1983	03.1991	805 LP	A79		0,65	
	1.4 Turbo	C1J 770-782	85/115	10.1986	12.1988	805 LP	A79		0,65	
	1.7	F2N 730	54/73	10.1986	12.1988	C 82 LS	A40	B6	0,8	L87
	1.7 i	F3N 718	54-55/73-75	10.1983	03.1991	RC 62 LS	A6	B17	0,8	L65

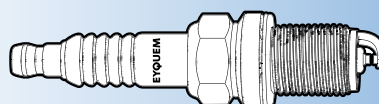

(1) Available until end of stock

- (a) 30 000 km
- (b) 60 000 km
- (c) Grey sticker on ignition coil
- (d) Green sticker on ignition coil

- (e) Hex 21 mm
- (f) Hex 16 mm
- (g) Recommended for cold weather



KW/HP



Box
10
Blister
4



F3-1

RENAULT

	1.7 i	F2N 712-742	55-64/75-87	10.1983	03.1991	C 82 LS	A40	B6	0,8	L87
	1.7	F2N 700-704	59/80	10.1983	12.1987	C 82 LS	A40	B6	0,8	L87
	1.7	F2N 732-742	64/87	06.1987	12.1988	C 82 LS	A40	B6	0,8	L87
	1.7	F2N 708-710-798	65/88	10.1986	12.1988	C 82 LS	A40	B6	0,8	L87
	1.7	F2N 700-704-708-730-732-796-798		10.1983	03.1991	C 82 LS	A40	B6	0,8	L87
11 Société (S37_)	1.7 i	F3N 708-722	66-70/90-98	10.1983	03.1991	C 82 LS	A40	B6	0,8	L87
	1.1	C1E 715-720	35/48	03.1983	06.1986	RC 52 LS	A9	B20	0,8	L65
	1.2	C1G 700-710	40/54	10.1984	12.1988	RC 52 LS	A9	B20	0,8	L65
12	1.4	C1J 715-C2J 730	44/60	03.1983	09.1986	RC 52 LS	A9	B20	0,8	L65
	1.3	810.02	37/50	07.1975	04.1980	C 42 S	A12	B7	0,6	N43
	1.3	810-02/97	40/54	10.1969	08.1980	C 42 S	A12	B7	0,6	N43
	1.3	810 702-702A-702B-705-706	37-40/50-54		08.1980	C 42 S	A12	B7	0,6	N43
	1.3	847- 705/706	44/60		08.1980	C 42 S	A12	B7	0,6	N43
12 Break (117_)	1.3 TS	810.05-06	44/60	08.1972	08.1980	C 42 S	A12	B7	0,6	N43
	1.3	810.02	37/50	07.1975	04.1980	C 42 S	A12	B7	0,6	N43
	1.3	810-02/97	40/54	10.1970	08.1980	C 42 S	A12	B7	0,6	N43
	1.3	810.05-06	44/60	08.1973	08.1980	C 42 S	A12	B7	0,6	N43
12 Société	1.3	810.02	37/50	07.1975	04.1980	C 42 S	A12	B7	0,6	N43
14 (121_)	1.2	129- 700-710	42-43/57-58	05.1976	06.1983	C 62 LJS	A19	B2	0,6	J65
	1.4	145-700 - 150-700 (X5J)	44-52/60-71	09.1979	06.1983	C 62 LJS	A19	B2	0,6	J65
15 (130_)	1.3	810.05	44/60	03.1972	08.1979	C 42 S	A12	B7	0,6	N43
	1.6	807.10	66/90	03.1972	10.1980	RC 62 LS	A6	B17	0,6	L65
16 (115_)	1.5	697.01	40/54	09.1965	10.1975	RC 62 LS	A6	B17	0,6	L65
	1.6	697-807			07.1976	RC 52 LS	A9	B20	0,6	L65
	1.6	843-701 - 843-702	48/65	01.1971	07.1979	RC 62 LS	A6	B17	0,6	L65
	1.6 TL	821 - 841	40/54	07.1975	08.1980	RC 52 LS	A9	B20	0,6	L65
	1.6 TL	821- 821.03-04	48/65	01.1971	08.1980	RC 52 LS	A9	B20	0,6	L65
	1.6 TA		52/71	01.1969	08.1980	RC 52 LS	A9	B20	0,6	L65
	1.6 TS	807- 807.04-807.05	61/83	09.1968	06.1980	RC 52 LS	A9	B20	0,6	L65
	1.6 TX	843- 843.01	68/92	06.1974	08.1980	RC 62 LS	A6	B17	0,6	L65
17	1.6	807.10	66/90	03.1972	10.1980	RC 62 LS	A6	B17	0,6	L65
	1.6 TS	843.05	68/92	06.1974	08.1979	RC 62 LS	A6	B17	0,6	L65
18 (134_)	1.4	847-720 847-721 - 847-722	47/64	04.1978	07.1986	RC 52 LS	A9	B20	0,6	L65
	1.6	A2M 723	52/71	08.1986	11.1993	RC 62 LS	A6	B17	0,6	L65
	1.6	841-717-718-727-728-A2M 723	54/73	04.1978	07.1986	RC 62 LS	A6	B17	0,6	L65
	1.6	841 725-726-795	54-58/73-79	04.1978	02.1986	RC 62 LS	A6	B17	0,6	L65
	1.6 TS	A6M 725-726	71/97	10.1981	07.1986	RC 62 LS	A6	B17	0,6	L65
	1.6 Turbo	807 727	80/109	10.1980	09.1982	805 LP	A79		0,6	
	1.6 Turbo	A5L 717-718	92/125	10.1982	07.1986	805 LP	A79		0,6	
	2.0 GTX, TX 4x4	J6R 711-714-715-716	77/105	11.1981	02.1986	C 72 LJS	A22		0,7	J87
18 Break (135_)	2.2 i TX	J7T 718-719	76/103	10.1983	02.1986	C 62 LJS	A19	B2	0,7	J65
	1.4	847 720-722	47/64	05.1979	07.1986	RC 52 LS	A9	B20	0,6	L65
	1.6	A2M 723	52/71	08.1986	11.1993	RC 62 LS	A6	B17	0,6	L65
	1.6	841-717- A2M 723	54/73	01.1982	07.1986	RC 62 LS	A6	B17	0,6	L65
	1.6 4x4	841-717- A2M 723	54/73	01.1983	07.1986	RC 62 LS	A6	B17	0,6	L65
	1.6	841 725-726	58/79	05.1979	09.1982	RC 62 LS	A6	B17	0,6	L65
	1.6 4x4	841 725	58/79	02.1979	06.1981	RC 62 LS	A6	B17	0,6	L65
	1.6 Turbo	807 727	80/109	09.1982	07.1986	805 LP	A79		0,6	
	1.6 Turbo	A5L 717-718	92/125	10.1982	07.1986	805 LP	A79		0,6	
	1.6 TS	A6M 725-726	71/97	05.1982	07.1986	RC 62 LS	A6	B17	0,6	L65
	1.6	A7L 752	82/112	10.1983	09.1986	805 LP	A79		0,6	
2.0 4x4	J6R 714-716	76/103	05.1983	12.1986	C 72 LJS	A22		0,7	J87	
2.0	J6R 716	77/105	10.1981	07.1986	C 72 LJS	A22		0,7	J87	
18 Société	1.4	847 720-722	47/64	05.1979	07.1986	RC 52 LS	A9	B20	0,6	L65
19 I (B/C53_)	1.2	C1G 730	40/54	01.1988	12.1992	RC 32 LS	A49	B19	0,9	L3
	1.2 i	E7F 730	46/63	05.1992		RFC 52 LS	A3	B16	0,9	F54
	1.4	C1J 742	43-44/58-60	09.1988		RC 52 LS	A9	B20	0,9	L65
	1.4	C2J 772	43/58	01.1989	12.1989	RC 52 LS	A9	B20	0,9	L65
	1.4	C3J 710-760	43/58	09.1988	04.1992	RC 32 LS	A49	B19	0,8	L3
	1.4	E6J 700-701-706	58-59/79-80	09.1988	12.1992	RFC 52 LS	A3	B16	0,9	F54
	1.4	E6J 700-701	59/80	01.1988	12.1992	FN 52 LS	A41		0,9	F54

- (f) Available until end of stock
- (a) 30 000 km
- (b) 60 000 km
- (c) Grey sticker on ignition coil
- (d) Green sticker on ignition coil

- (e) Hex 21 mm
- (f) Hex 16 mm
- (g) Recommended for cold weather

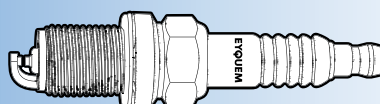

EYQUEM



Box 10
Blister 4



F3 → 1

RENAULT

	1.4	C2J 772-776-782	49/67	09.1988	12.1989	RC 52 LS	A9	B20	0,9	L65
	1.4 e	E7J 700	55-59/75-81	05.1990		RFC 52 LS	A3	B16	0,9	F54
	1.4	E6J 700-706	59/80	01.1992	12.1995	FN 52 LS	A41		0,8	F54
	1.4 i	E7J 706-745-742	55-59/75-81	05.1990		RFC 52 LS	A3	B16	0,9	F54
	1.4 i	E7J 707		05.1990		RFC 52 LS	A3	B16	0,9	F54
	1.6	C3L				RC 52 LS	A9	B20	0,9	L65
	1.7	F3N 718-740-741	54/73	09.1988	04.1992	RC 62 LS	A6	B17	0,8	L65
	1.7	F2N 712	55/75	09.1988		C 82 LS	A40	B6	0,8	L87
	1.7	F3N 742-743	66/90	09.1988	04.1992	C 82 LS	A40	B6	0,8	L87
	1.7	F2N 720	55-68/75-92	09.1988	04.1992	C 82 LS	A40	B6	0,8	L87
	1.8 16V	F7P 704	99/135	06.1989	04.1992	RFC 58 LS3	A16	B33	1,2	
19 I Chamade (L53_)	1.2	C1G 730	40/54	01.1988	12.1992	RC 32 LS	A49	B19	0,9	L3
	1.4	C2J 772	43/58	07.1988	04.1992	RC 52 LS	A9	B20	0,9	L65
	1.4	C3J 710	43/58	07.1988	04.1992	RC 32 LS	A49	B19	0,8	L3
	1.4	E7J 700	55/75	05.1990	04.1992	RFC 52 LS	A3	B16	0,9	F54
	1.4	E6J 700-706	57/78	07.1988	08.1990	RFC 52 LS	A3	B16	0,9	F54
	1.7	F3N 740-741	54/73	10.1989	04.1992	RC 62 LS	A6	B17	0,8	L65
	1.7	F3N 742-743	66/90	07.1988	04.1992	C 82 LS	A40	B6	0,8	L87
	1.7	F2N 720-721	68/92	09.1988	12.1992	C 82 LS	A40	B6	0,8	L87
	1.7	F3N 746	79/107	08.1988	12.1992	RC 72 LS	A32	B26	0,8	L87
	1.8 16V	F7P 704	99/135	10.1989	04.1992	RFC 58 LS3	A16	B33	1,2	
19 I Cabriolet (D53_)	1.7	F2N 724	55/75	07.1991	04.1992	C 82 LS	A40	B6	0,8	L87
	1.7	F3N 742-743	66/90	07.1991	04.1992	C 82 LS	A40	B6	0,8	L87
	1.8 16V	F7P 700-704	101/137	07.1991	04.1992	RFC 58 LS3	A16	B33	1,2	
19 I Soci�t� (S53_)	1.2	C1G 730	40/54	01.1988	12.1992	RC 32 LS	A49	B19	0,9	L3
	1.4	E6J 700	59/80	01.1988	12.1992	RFC 52 LS	A3	B16	0,9	F54
19 II (B/C53_)	1.2	C1G 730	40/54	04.1992	12.1995	RC 32 LS	A49	B19	0,9	L3
	1.4	C3J 710	43/58	04.1992	12.1995	RC 32 LS	A49	B19	0,8	L3
	1.4	E7J 742	55/75	01.1992	12.1995	RFC 52 LS	A3	B16	0,9	F54
	1.4	E6J 700- E7J 706	59/80	01.1992	12.1995	RFC 52 LS	A3	B16	0,9	F54
	1.7	F3N 740-741	54/73	04.1992	12.1995	RC 62 LS	A6	B17	0,8	L65
	1.7	F3N 743	66/90	04.1992	12.1995	RC 82 LS	A78		0,8	L87
	1.7	F3N 746	79/107	05.1992	09.1994	RC 72 LS	A32	B26	0,8	L87
	1.8	F3P 706-707-708-760	65-66/88-90	04.1992	12.1995	RC 52 LS	A9	B20	0,9	L65
	1.8	F3P 706-760	66/90	04.1992	12.1995	RC 52 LS	A9	B20	0,9	L65
	1.8	F3P 682-765	79/107	05.1994	12.1995	RC 52 LS	A9	B20	0,9	L65
	1.8	F3P 700	81/110	04.1992	05.1994	RC 52 LS	A9	B20	0,9	L65
	1.8 16V	F7P 704	99/135	04.1992	12.1995	RFC 58 LS3	A16	B33	1,2	
19 II Chamade (L53_)	1.4	E7J 742	55/75	11.1993	12.1995	RFC 52 LS	A3	B16	0,9	F54
	1.4	E6J 700	57/78	10.1994	11.1995	RFC 52 LS	A3	B16	0,9	F54
	1.4	E7J 706	59/80	10.1994	11.1995	RFC 52 LS	A3	B16	0,9	F54
	1.4	C3J 710	43/58	04.1992	12.1995	RC 32 LS	A49	B19	0,8	L3
	1.4	C1J 742- C2J 772	44/60	05.1992	09.1994	RC 52 LS	A9	B20	0,9	L65
	1.7	F3N 740-741	54/73	04.1992	12.1995	RC 62 LS	A6	B17	0,8	L65
	1.7	F3N 740-741	55/75	05.1992	11.1995	RC 62 LS	A6	B17	0,8	L65
	1.7	F3N 742-743	66/90	04.1992	12.1995	RC 82 LS	A78		0,8	L87
	1.7	F3N 720-721	68/92	01.1993	08.1995	RC 82 LS	A78		0,8	L87
	1.8	F3P 682	79/107	05.1994	12.1995	RC 52 LS	A9	B20	0,9	L65
	1.8	F3P 704-705-706-707-708-760	65/88	04.1992	12.1995	RC 52 LS	A9	B20	0,9	L65
	1.8	F3P 706-760	66/90	04.1992	12.1995	RC 52 LS	A9	B20	0,9	L65
	1.8	F3P 765	67/91	05.1992	09.1994	RC 52 LS	A9	B20	0,9	L65
	1.8	F3P 700-706	79/107	05.1992	11.1995	RC 52 LS	A9	B20	0,9	L65
	1.8	F3P 700	81/110	04.1992	05.1994	RC 52 LS	A9	B20	0,9	L65
	1.8 16V	F7P 704	99/135	04.1992	12.1995	RFC 58 LS3	A16	B33	1,2	
19 II Cabriolet (D53_, 853_)	1.7	F3N 742-743	66/90	04.1992	09.1993	RC 82 LS	A78		0,8	L87
	1.8	F3P 704-705-706-707-708-760	65/88	04.1992	06.1996	RC 52 LS	A9	B20	0,9	L65
	1.8	F3P 706-760	66/90	09.1993	06.1996	RC 52 LS	A9	B20	0,9	L65
	1.8	F3P 682-764-765	79/107	07.1994	06.1996	RC 52 LS	A9	B20	0,9	L65
	1.8 16V	F7P 704	99/135	04.1992	06.1996	RFC 58 LS3	A16	B33	1,2	
19 II Soci�t� (S53_)	1.2	C1G 730	40/54	03.1992	12.1995	RC 32 LS	A49	B19	0,9	L3
	1.4	E6J 700	59/80	03.1992	12.1995	RFC 52 LS	A3	B16	0,9	F54
20 (127_)	1.6 L, TL GTL	843	66-71/90-97	10.1975	10.1981	RC 62 LS	A6	B17	0,6	L65



(1) Available until end of stock

- (a) 30 000 km
- (b) 60 000 km
- (c) Grey sticker on ignition coil
- (d) Green sticker on ignition coil

- (e) Hex 21 mm
- (f) Hex 16 mm
- (g) Recommended for cold weather



Box
10

Blister
4



F3-D1

RENAULT

	2.0	843 720-721	71/97	05.1977	12.1983	RC 62 LS	A6	B17	0,6	L65
	2.0	829 702-703	76/103	10.1977	12.1983	C 62 LJS	A19		0,6	J65
	2.0	829 702-703	76/103	10.1977	12.1983	C 72 LJS	A22		0,6	J87
	2.0	829 700-701-829.01	70/95	10.1977	10.1980	C 72 LJS	A22		0,6	J87
	2.0	J6R 704-705	80/109	10.1977	12.1983	RC 52 LJS	A62	B27	0,6	J65
	2.2 TX	851 700-701	85/115	10.1980	12.1983	C 72 LJS	A22		0,6	J87
21 (B48_)	1.4	C2J 770	51/69	09.1989	05.1993	C 52 LS	A1	B1	0,8	L65
	1.4	C2J - C2L	51-53/70-72	08.1988	12.1994	RC 52 LS	A9	B20	0,8	L65
	1.7	F3N 726	54-55/73-75	03.1986	12.1994	RC 62 LS	A6	B17	0,8	L65
	1.7	F2N 712	55/75	07.1989	05.1993	C 82 LS	A40	B6	0,8	L87
	1.7	F3N 722-723	66/90	09.1989	06.1994	C 82 LS	A40	B6	0,8	L87
	1.7	F2N 711-754	65/88	07.1989	05.1993	C 82 LS	A40	B6	0,8	L87
	1.7	F2N	66-70/90-98	03.1986	12.1994	C 82 LS	A40	B6	0,8	L87
	2.0 i	J7R 750-751	86/117	10.1986	03.1993	C 82 LJS	A52		0,9	J87
	2.0 i	J7R 746-747	88/120	09.1989	12.1993	RC 52 LJS	A62	B27	0,9	J65
	2.0 i	J7R 740	99/135	02.1990	10.1992	RFC 62 LS3	A56		1,2	
	2.0 i 4x4	J7R 740	99/135	09.1990	10.1992	RFC 62 LS3	A56		1,2	
	2.0 TXi	J7R 740-754	100/136	07.1989	05.1993	RFC 62 LS3	A56		1,2	
	2.2 i	J7T 754-755	79/107	10.1986	12.1995	RC 72 LJS	A88		0,9	J87
	2.2 i 4x4	J7T 754-755	79/107	07.1990	06.1994	RC 72 LJS	A88		0,9	J87
21 A (L48_)	1.4	C2J 770	51/69	06.1988	12.1993	C 52 LS	A1	B1	0,8	L65
	1.7	F2N 750	54/73	07.1986	02.1994	C 82 LS	A40	B6	0,8	L87
	1.7	F3N 726	54/73	07.1986	02.1994	RC 62 LS	A6	B17	0,8	L65
	1.7	F2N 712	55/75	03.1986	12.1987	C 82 LS	A40	B6	0,8	L87
	1.7	F2N 752	64/87	06.1987	04.1989	C 82 LS	A40	B6	0,8	L87
	1.7	F2N 710	65/88	03.1986	03.1993	C 82 LS	A40	B6	0,8	L87
	1.7	F3N 722-723	66/90	09.1989	02.1994	C 82 LS	A40	B6	0,8	L87
	1.7	F3N 722-723	69/94	03.1986	02.1994	C 82 LS	A40	B6	0,8	L87
	2.0	J6R 758-759-792-793	75/102	03.1986	12.1993	C 82 LJS	A52		0,9	J87
	2.0	J6R 792-793	76/103	04.1988	06.1989	C 82 LJS	A52		0,9	J87
	2.0	J6R 758	78/106	05.1991	10.1993	C 82 LJS	A52		0,9	J87
	2.0	J7R 750-751	85/115	03.1986	12.1988	C 82 LJS	A52		0,9	J87
	2.0	J7R 750-751	86/117	04.1986	06.1989	C 82 LJS	A52		0,9	J87
	2.0	J7R 746-747	88/120	03.1986	12.1993	RC 52 LJS	A62	B27	0,9	J65
	2.0	J7R 740	99/135	02.1990	06.1994	RFC 62 LS3	A56		1,2	
	2.0 4x4	J7R 740	99/135	12.1989	02.1994	RFC 62 LS3	A56		1,2	
	2.0 Turbo, Quadra	J7R 756	119/162	02.1990	10.1992	805 LJSP	A96		0,6	
	2.0 Turbo, Quadra	J7R 752	129/175	04.1987	10.1993	805 LJSP	A96		0,6	
	2.2 i, 4x4	J7T 754-755	79/107	07.1986	02.1994	RC 72 LJS	A88		0,9	J87
	2.2 i	J7T 755	81/110	04.1986	06.1989	RC 72 LJS	A88		0,9	J87
21 Nevada (K48_)	1.7	F2N 750	54/73	06.1986	12.1989	C 82 LS	A40	B6	0,8	L87
	1.7	F3N 726	54/73	05.1988	06.1993	RC 62 LS	A6	B17	0,8	L65
	1.7	F2N 712	55/75	06.1986	03.1993	C 82 LS	A40	B6	0,8	L87
	1.7	F2N 752	64/87	06.1987	04.1989	C 82 LS	A40	B6	0,8	L87
	1.7	F2N 710	65/88	10.1986	12.1988	C 82 LS	A40	B6	0,8	L87
	1.7	F3N 722-723	66/90	10.1989	12.1993	C 82 LS	A40	B6	0,8	L87
	1.7	F3N 722-723	69/94	06.1986	12.1989	C 82 LS	A40	B6	0,8	L87
	2.0	J6R 758-759-792	75/102	06.1991	05.1993	C 82 LJS	A52		0,9	J87
	2.0	J7R 750-751	85/115	06.1986	12.1988	C 82 LJS	A52		0,9	J87
	2.0	J7R 746-747	88/120	03.1986	12.1993	RC 52 LJS	A62	B27	0,9	J65
	2.0 4x4	J7R 746-747	88/120	03.1989	12.1993	RC 52 LJS	A62	B27	0,9	J65
	2.0	J7R 750-751	86/117	07.1989	06.1992	C 82 LJS	A52		0,9	J87
	2.0	J7R 740	99/135	06.1990	02.1994	RFC 62 LS3	A56		1,2	
	2.2 i, 4x4	J7T 754-755	79/107	06.1986	12.1993	RC 72 LJS	A88		0,9	J87
21 Nevada Soci�t� (S48_)	1.7	F2N 710	65/88	10.1986	04.1995	C 82 LS	A40	B6	0,8	L87
25 (B29_)	2.0 i	J6R 706-707-760-762-763 74/101		01.1984	12.1992	C 72 LJS	A22		0,9	J87
	2.0 i	J6R 706-707-760-762-763 74/101		01.1984	12.1992	RC 72 LJS	A88		0,9	J87
	2.0 i	J7R 722-723	88/120	03.1987	12.1993	C 82 LJS	A52		0,9	J87
	2.0 i 12V	J7R 726	99/135	06.1989	12.1992	RFC 62 LS3	A56		1,2	
	2.0 i 12V	J7R 720-721	103/140	06.1988	12.1993	RFC 62 LS3	A56		1,2	
	2.2 i	J7T 708	76/103	11.1985	03.1989	RC 52 LJS	A62	B27	0,8	J65
	2.2 i	J7T 732	76/103	11.1985	03.1989	C 82 LJS	A52		0,9	J87
	2.2 i	J7T 708	79/108	09.1986	12.1992	RC 52 LJS	A62	B27	0,8	J65
	2.2 i	J7T 732-733	79/108	09.1986	12.1992	C 82 LJS	A52		0,9	J87

(f) Available until end of stock

(a) 30 000 km

(b) 60 000 km

(c) Grey sticker on ignition coil

(d) Green sticker on ignition coil

(e) Hex 21 mm

(f) Hex 16 mm

(g) Recommended for cold weather



EYQUEM



Box 10
Blister 4



F3 → 1

RENAULT

	2.2 i	J7T 706-707-714-715	89/121	04.1984	12.1989	C 82 LJS	A52	0,9	J87
	2.2 i	J7T 730-731-722	91/124	04.1984	12.1989	C 82 LJS	A52	0,9	J87
	2.4 V6 Turbo	Z7U 702	133/181	10.1984	05.1990	805 LJSP	A96	0,65	
	2.5 V6 Turbo	Z7U 700	151/205	01.1990	12.1992	805 LJSP	A96	0,65	
	2.7 V6 Injection	Z7V 708-709-711	104/141	04.1984	08.1989	RC 72 LJS	A88	0,8	J87
	2.8 V6 Injection	Z7W 702	100/136	06.1986	02.1988	RC 72 LJS	A88	0,8	J87
	2.8 V6 Injection	Z7W 706-707-709	110/150	06.1987	12.1992	RC 72 LJS	A88	0,8	J87
	2.8 V6 Injection	Z7W 700	115/156	06.1987	02.1990	RC 72 LJS	A88	0,8	J87
30 (127_)	2.7	112	92/125	08.1976	06.1978	C 62 LJS	A19	B2	0,6 J65
	2.7 TS	144	94/128	07.1978	01.1984	C 62 LJS	A19	B2	0,7 J65
	2.7	112 700-701-702-703	96/131	02.1975	07.1976	C 62 LJS	A19	B2	0,6 J65
	2.7 TX	140 700-701-702-703	105/143	10.1978	12.1983	C 62 LJS	A19	B2	0,6 J65
A310	2.7 V6	112- 730/731 (PRV)		09.1976	06.1985	C 62 LJS	A19	B2	0,65 J65
A610	2.9 V6	Z6W- 700 / 702		03.1985	12.1992	C 82 LJS	A52	0,9	J87
	V6 2.5 i Turbo	Z7U- 730 / 734	154/209	03.1985	12.1992	805 LJSP	A96	0,65	
AVANTIME (DE0_)	2.0 16V Turbo	F4R 760-761	120/163	04.2002	05.2003	RFN 58 LZDP	A519	0,9	
	3.0 V6	L7X 720 - 721	152/207	09.2001	05.2003	RFN 42 HZDP5	A184	1,1	
CAPTUR (J5)	NEW 0.9 TCe 90	H4B 400	66/90	06.2013		RWN 42 HSIPS	A542	0,75	
	NEW 1.2 TCe 120	H5F 408	87/118	01.2016		RWN 42 HSIPS	A542	0,75	
	NEW 1.2 TCe 120	H5F 403	88/120	06.2013		RWN 42 HSIPS	A542	0,75	
CLIO I (B/C57_, 5/357_)	1.0 i	D7D- 760	43/58			RFC 58 LZ2E	A10	B31	0,9 F54
	1.1	C1E 700	35-36/49-50	06.1990	03.1996	RC 32 LS	A49	B19	0,75 L3
	1.2	D7F 730	40-43/54-58	01.1996	09.1998	RFC 58 LZ2E	A10	B31	0,9 F54
	1.2	E7F 706	40/54	01.1991	01.1996	FC 42 LS	A15	B14	0,8 F54
	1.2	E7F 750-700-708	43/58	05.1990	09.1998	FC 42 LS	A15	B14	0,8 F54
	1.2	E5F 710	44/60	05.1990	03.1996	FC 42 LS	A15	B14	0,8 F54
	1.2	C3G 720	40/54	01.1996	12.1996	RC 32 LS	A49	B19	0,75 L3
	1.4	E7J 756-757	55/75	01.1991	09.1998	RFC 52 LS	A3	B16	0,8 F54
	1.4	E7J 718-719-704-601	58/79	01.1991	09.1998	RFC 52 LS	A3	B16	0,8 F54
	1.4 i	E7J 710 - 711	59/80	01.1991	09.1998	RFC 52 LS	A3	B16	0,8 F54
	1.7	F2N- 770	68/92	06.1990	03.1996	C 82 LS	A40	B6	0,8 L87
	1.8 i	F3P 710-714	65/88	01.1991	09.1998	RC 52 LS	A9	B20	0,9 L65
	1.8 i	F3P 755	66/90	08.1990	04.1996	RC 52 LS	A9	B20	0,9 L65
	1.8 i	F3P 754-755	66/90	08.1994	09.1998	RC 52 LS	A9	B20	0,9 L65
	1.8 i	F3P 710	70/95	01.1991	09.1998	RC 52 LS	A9	B20	0,9 L65
	1.8 Rsi	F3P 758	79/107	08.1995	09.1998	RC 52 LS	A9	B20	0,9 L65
	1.8 Rsi	F3P 712	80/109	01.1993	08.1995	RC 52 LS	A9	B20	0,9 L65
	1.8 i 16V	F7P 722	99/135	01.1991	03.1993	RFC 58 LS3	A16	B33	1,2
	2.0 i 16V Williams	F7R 700	108/147	01.1994	09.1998	RFC 58 LS3	A16	B33	1,2
	2.0 i 16V Williams	F7R 700	110/150	04.1993	03.1996	RFC 58 LS3	A16	B33	1,2
CLIO I Box (S57_)	1.1	C1E 700	34/46	01.1991	09.1998	RC 32 LS	A49	B19	0,75 L3
	1.2	E7F 706	40/54	01.1991	09.1998	FC 42 LS	A15	B14	0,9 F54
	1.2	E7F 750	44/60	01.1991	09.1998	FC 42 LS	A15	B14	0,9 F54
	1.2	C3G 720	40/54	06.1994	02.1998	RC 32 LS	A49	B19	0,75 L3
CLIO II (BBO/1/2_, CBO/1/2_)	1.2 i RC, RL, RN, RT	D7F 730	44/60	04.1996	09.1998	FN 52 LS	A41	0,8	F54
	1.2 i	D7F 720-722-726 - 744 - 746 -764 -766	44/60	09.1998		RFC 58 LZ2E	A10	B31	0,9 F54
	1.2 i	D7F- Euro 2000 Cat	44/60	05.2000		RFC 58 LZP	A178	0,9	F54
	1.2 i LPG	D7F 764 - 766	43/58	09.1998	06.2009	RFC 58 LZ2E	A10	B31	0,9 F54
	1.2	D7F 722	44/60	03.1999	05.2001	RFC 58 LZ2E	A10	B31	0,9 F54
	1.2 i 16V	D4F	55/75	06.2001		RWC 52 HSK	A197	B58	0,9
	1.2 i 16V	D4F 706-712-714-722-728	55/75	06.2001		RWC 52 HSK	A197	B58	0,9
	1.4 i	E7J 634-700-780	55/75	01.1998	05.2005	RFN 58 LZ (b)	A7	B28	0,9 F54
	1.4 i	E7J 634-780, K7J 700	55/75	01.1998	05.2005	RFN 58 LZ3A (g)	A515	0,9	
	1.4 i 16V	K4J 712-713	70/95	10.1999	09.2004	RFN 58 LZ (b)	A7	B28	0,9 F54
	1.4 i 16V	K4J 712-713	70/95	10.1999	09.2004	RFN 58 LZ3A (g)	A515	0,9	
	1.4 i 16V	K4J 710-711-712-713	72/98	08.2000		RFN 58 LZ (b)	A7	B28	0,9 F54
	1.4 i 16V	K4J 710-711-712-713	72/98	08.2000		RFN 58 LZ3A (g)	A515	0,9	
	1.6 i	K7M 744- 745	66/90	03.1998	05.2005	RFC 58 LZ2E	A10	B31	0,9 F54
	1.6 i 16V	K4M 708-740-742-743- 744-745-748	79/107	09.1998		RFN 58 LZ (b)	A7	B28	0,9 F54
	1.6 i 16V	K4M 708-740-742-743- 744-745-748	79/107	09.1998		RFN 58 LZ3A (g)	A515	0,9	
	2.0 i 16V	F4R	120/163	09.1998		RFN 58 LZ (b)	A7	B28	0,9 F54

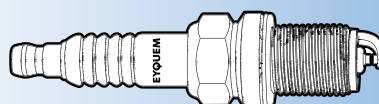

(1) Available until end of stock

- (a) 30 000 km
- (b) 60 000 km
- (c) Grey sticker on ignition coil
- (d) Green sticker on ignition coil

- (e) Hex 21 mm
- (f) Hex 16 mm
- (g) Recommended for cold weather



KW/HP



Box
10

Blister
4



F3-D1

RENAULT

	2.0 i 16V	F4R	120/163	09.1998		RFN 58 LZ3A (g)	A515		0,9	
	2.0 16V Sport	F4R 730-736	124/169	02.2000		RFN 58 LZ (b)	A7	B28	0,9	F54
	2.0 16V Sport	F4R 730-736	124/169	02.2000		RFN 58 LZ3A (g)	A515		0,9	
	2.0 16V Sport	F4R 738	132/180	01.2004		RFC 62 LSDP5	A507		1,1	
	3.0 V6 Sport	L7X 760	166/226	11.2000	12.2002	RFN 42 HZP5	A512		1,1	
	3.0 V6 Sport	L7X 762	187/254	12.2002		RFN 42 HZP5	A512		1,1	
CLIO II Box (SB0/1/2_)	1.1	D7F 720-726-746	43/58	09.1998		RFC 58 LZ2E	A10	B31	0,9	F54
	1.2 i	D7F 722-726 -746	44/60	03.1999	10.2003	RFC 58 LZ2E	A10	B31	0,9	F54
CLIO III (BRO/1, CRO/1)	1.2 i 16V	D4F 764	43/58	06.2006	08.2010	RWC 52 HSK	A197	B58	0,9	
	1.2 i 16V	D4F 740	48/65	06.2005		RWC 52 HSK	A197	B58	0,9	
	1.2 i 16V	D4F 740-706	55/75	06.2005		RWC 52 HSK	A197	B58	0,9	
	1.2 16V Hi-Flex	D4F 740-742	55/75	07.2008		RWC 52 HSK	A197	B58	0,9	
	1.2 Ethanol		55/75	07.2008		RWC 52 HSK	A197	B58	0,9	
	1.2 i 16V	D4F 764	58/79	06.2005		RWC 52 HSK	A197	B58	0,9	
	1.2 i 16V	D4F 784	74/101	05.2007		RWC 62 HSDPS	A520		0,7	
	1.2 i 16V	D4F 786	76/103	09.2010		RWC 62 HSDPS	A520		0,7	
	1.2 16V Tce	D4F 780	74/101	05.2007		RWC 62 HSDPS	A520		0,7	
	1.4 i 16V	K4J 780	72/98	09.2005		RFN 58 LZ (b)	A7	B28	0,9	F54
	1.4 i 16V	K4J 780	72/98	09.2005		RFN 58 LZ3A (g)	A515		0,9	
	1.6 i 16V	K4M 804	65/88	06.2005		RFN 58 LZ (b)	A7	B28	0,9	F54
	1.6 i 16V	K4M 804	65/88	06.2005		RFN 58 LZ3A (g)	A515		0,9	
	1.6 i 16V	K4M 800-801	82/112	06.2005		RFN 52 LZ	A27		0,9	F54
CLIO IV (BH_)	2.0 16V	M4R 700-701	102/139	09.2006		RWC 58 HSE5DP	A528		1,15	
	NEW 0.9 TCe 90	H4B 400	66/90	11.2012		RWN 42 HSIPS	A542		0,75	
	NEW 1.2 TCe 120	H5F 412	87/118	01.2016		RWN 42 HSIPS	A542		0,75	
	NEW 1.2 TCe 120	H5F 403	88/120	03.2013		RWN 42 HSIPS	A542		0,75	
	NEW 1.2 16v	D4F 740 - OE 22401 9202R, 82000 30765, 82003 32273, 82005 92215, 82006 62185, 86710 16890	54/73	11.2012		RWC 58 HSEW	A530		0,9	
	1.2 16v	D4F 740	54/73	11.2012		RWC 62 HSDPS	A520		0,7	
CLIO IV Grandtour (KH_)	NEW 0.9 TCe 90	H4B 400	66/90	01.2013		RWN 42 HSIPS	A542		0,75	
	NEW 1.2 16V	D4F 740 - OE 22401 9202R, 82000 30765, 82003 32273, 82005 92215, 82006 62185, 86710 16890	54/73	01.2013		RWC 58 HSEW	A530		0,9	
	1.2 16V	D4F 740 - OE 82005 87901	54/73	01.2013		RWC 62 HSDPS	A520		0,7	
	NEW 1.2 TCe 120	H5F 412	87/118	01.2016		RWN 42 HSIPS	A542		0,75	
	NEW 1.2 TCe 120	H5F 403	88/120	03.2013		RWN 42 HSIPS	A542		0,75	
CLIO Grandtour (KRO/1_)	1.2 16V	D4F 740	55/75	02.2008		RWC 52 HSK	A197	B58	0,9	
	1.2 16V Hi-Flex	D4F 740	55/75	02.2008		RWC 52 HSK	A197	B58	0,9	
	1.2 16V	D4F 764	58/79	02.2008		RWC 52 HSK	A197	B58	0,9	
	1.2 16V	D4F 784	74/101	02.2008		RWC 62 HSDPS	A520		0,7	
	1.4 16V	K4J 780	72/98	02.2010		RFN 58 LZ (b)	A7	B28	0,9	F54
	1.4 16V	K4J 780	72/98	02.2010		RFN 58 LZ3A (g)	A515		0,9	
	1.2 16V	D4F 786	76/103	09.2010		RWC 62 HSDPS	A520		0,7	
	1.6 16V	K4M 800-801	82/112	02.2008		RFN 52 LZ	A27		0,9	F54
ESPACE I (J11_)	2.0	J6R 734	74/101	01.1988	12.1990	C 72 LJS	A22		0,9	J87
	2.0	J6R 234-236	80/109	07.1984	12.1990	C 72 LJS	A22		0,9	J87
	2.0	J7R 760	87/118	01.1989	12.1990	C 82 LJS	A52		0,9	J87
	2.0 i Quadra	J7R 760	87/118	03.1988	12.1992	C 82 LJS	A52		0,9	J87
	2.2 i	J7T 770	79/107	07.1986	12.1990	C 72 LJS	A22		0,9	J87
	2.2 i Quadra	J7T 770	79/107	01.1988	12.1990	C 72 LJS	A22		0,9	J87
ESPACE II (J/S63_)	2.0	J7R 768	76/103	01.1991	10.1996	C 62 LJS	A19	B2	0,9	J65
	2.0 i	J7R 768	77/105	01.1991	12.1996	C 62 LJS	A19	B2	0,9	J65
	2.2 i	J7T 772-773	79/107	01.1991	12.1996	C 72 LJS	A22		0,9	J87
	2.2 i	J7T 776	81/110	01.1991	12.1996	C 52 LJS	A23		0,9	J65
	2.9 i V6	Z7W 712-713-717	110/150	04.1994	12.1996	C 72 LJS	A22		0,9	J87
	3.0 V6	Z7X 775	123/167	10.1996		RFC 58 LS3	A16	B33	1,2	
ESPACE III (JE0_)	2.0 i	F3R 728-729-742-768-769	85/115	10.1996	06.2000	RC 52 LS	A9	B20	0,8	L65
	2.0 i 16V	F4R 700-701	102/139	09.2001	10.2002	RFN 58 LZ (b)	A7	B28	0,9	F54
	2.0 i 16V	F4R 700-701	102/139	09.2001	10.2002	RFN 58 LZ3A (g)	A515		0,9	
	2.0 i 16V	F4R 700-701-702	103/140	11.1998	10.2002	RFN 58 LZ (b)	A7	B28	0,9	F54
	2.0 i 16V	F4R 700-701-702	103/140	11.1998	10.2002	RFN 58 LZ3A (g)	A515		0,9	

(1) Available until end of stock

(a) 30 000 km

(b) 60 000 km

(c) Grey sticker on ignition coil

(d) Green sticker on ignition coil

(e) Hex 21 mm

(f) Hex 16 mm

(g) Recommended for cold weather

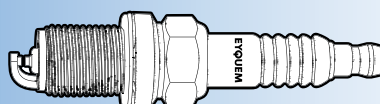

EYQUEM



Box 10
Blister 4



F3 → 1

RENAULT

	3.0	Z7X 775	123/167	11.1996	10.1998	RFC 58 LS3	A16	B33	1,2	
	3.0 i V6 24V	L7X 727	140/190	10.1998	10.2002	RFC 62 LSDP5	A507		1.1	
ESPACE IV (JK0/1_)	2.0	F4R 792	100/136	11.2002		RFN 58 LZDP	A519		0,9	
	2.0 Turbo	F4R 794-795-796-797	120/163	11.2002		RFN 58 LZDP	A519		0,9	
	2.0	F4R 797-897-796-896	125/170	04.2005		RFN 58 LZDP	A519		0,9	
	3.5 V6	V4Y 711 - 715	177/241	11.2002		RFN 42 HZP5	A512		1.1	
ESTAFETTE (213)	1.1	688.01	29/39	02.1962	12.1981	C 32 S	A8	B3	0,6	N43
	1.3	688- 701 - 810.01	29/39	08.1969	09.1980	C 32 S	A8	B3	0,6	N43
EXPRESS Camionette (F40, G40_)	1.0	C1C 706	27/37	02.1986	05.1992	RC 52 LS	A9	B20	0,8	L65
	1.0	C1C 706	31/42	09.1985	08.1991	C 52 LS	A1	B1	0,8	L65
	1.1	C1E 756	33/45	06.1987	09.1991	C 52 LS	A1	B1	0,8	L65
	1.1	C1E 756-760-762-764-792	33/45	07.1985	07.1995	RC 32 LS	A49	B19	0,8	L3
	1.1	C1E 750-752-754	33/45	07.1985	07.1995	RC 52 LS	A9	B20	0,8	L65
	1.2	C1G 726	40/54	09.1991	08.1993	RC 32 LS	A49	B19	0,8	L3
	1.2	C3G 710-712	40/54	09.1991	08.1993	RC 32 LS	A49	B19	0,8	L3
	1.4	E7J 720-724-726-773	55/75	09.1991	12.1992	FC 52 LS	A2	B9	0,9	F54
	1.4	E7J 720-724-726-773	55/75	01.1993	03.1998	RFC 52 LS	A3	B16	0,9	F54
	1.4	E7J 728	58/79	01.1994	03.1998	RFC 52 LS	A3	B16	0,9	F54
	1.4	E7J 773	59/80	05.1995	08.1997	RFC 52 LS	A3	B16	0,9	F54
	1.4	C1J 768-780	43/58	03.1986	08.1991	C 52 LS	A1	B1	0,8	L65
	1.4	C3J 700-702-760-762	43/58	08.1988	03.1998	RC 52 LS	A9	B20	0,8	L65
	1.4	C2J 784	44/60	03.1986	08.1991	C 52 LS	A1	B1	0,8	L65
EXPRESS - RAPID	1.0	C1C 706	27-31/37-42	03.1986	08.1991	RC 52 LS	A9	B20	0,8	L65
	1.1	C1E 750	34/46	09.1985	08.1991	RC 52 LS	A9	B20	0,8	L65
	1.1	C1E- 792		03.1986	08.1991	RC 52 LS	A9	B20	0,8	L65
	1.1	C1E- 762 - 764		08.1990		RC 32 LS	A49	B19	0,8	L3
	1.2	C1G- 726 - 730	40/54	09.1991		RC 32 LS	A49	B19	0,8	L3
	1.2 i	C3G 710-712	40/54	09.1991		RC 32 LS	A49	B19	0,8	L3
	1.4	C1J - C2J	52-53/71-72	03.1986	08.1991	RC 52 LS	A9	B20	0,8	L65
	1.4	E6J		09.1991		RFC 52 LS	A3	B16	0,9	F54
	1.4 i	C3J	59/80	03.1986		RC 52 LS	A9	B20	0,8	L65
	1.4 i	E7J 720-724-726-728-773	58-59/79-80	09.1991		RFC 52 LS	A3	B16	0,9	F54
	1.6	C3L				RC 52 LS	A9	B20	0,8	L65
FLUENCE (L30)	1.6 16V	K4M 838 - K4M 839	81/110	02.2010		RFN 52 LZ	A27		0,9	F54
	1.6 16V	K4M 838	82/112	02.2010		RFN 52 LZ	A27		0,9	F54
	2.0 16V	M4R 714-751	103/140	02.2010		RWC 58 HSE5DP	A528		1,15	
FUEGO (136_)	1.4	847 720	47/64	02.1980	10.1985	RC 52 LS	A9	B20	0,6	L65
	1.6	A2M 723	52/71	03.1980	10.1985	RC 62 LS	A6	B17	0,6	L65
	1.6 TS	843 723-724 - A6M 725-726	71/97	10.1980	10.1985	RC 62 LS	A6	B17	0,6	L65
	1.6 Turbo	A5L 750-723-752	97/132	09.1983	10.1985	805 LP	A79		0,6	
	2.0 GTS	829 710, J6R 710-711-712-713-714-715-726	81/110	10.1980	10.1985	C 72 LJS	A22		0,65	J87
FUEGO	2.2 i	J7T- 718 - 719		10.1983	10.1985	RC 52 LJS	A62	B27	0,7	J65
GRAND SCÉNIC II (JMO/1_)	1.6 Flex	K4M 766	82/112	06.2006	11.2008	RFN 58 LZ (b)	A7	B28	0,9	F54
	1.6 Flex	K4M 766	82/112	06.2006	11.2008	RFN 58 LZ3A (g)	A515		0,9	
	1.6 16V	K4M 761-782	83/113	04.2004		RFN 52 LZ	A27		0,9	F54
	2.0	F4R 770-771	99/135	04.2004		RFN 58 LZ (b)	A7	B28	0,9	F54
	2.0	F4R 770-771	99/135	04.2004		RFN 58 LZ3A (g)	A515		0,9	
	2.0 16V	F4R 776	120/163	04.2004		RFN 58 LZDP	A519		0,9	
GRAND SCÉNIC III NEW (JZO/1_)	1.2 TCe	H5F 400	85/116	04.2012		RWN 42 HSIPS	A542		0,75	
	1.4 16 V	H4J 700	96/131	02.2009		RWC 62 HSDPS	A520		0,7	
	1.6 16 V	K4M 858	81/110	05.2009		RFN 52 LZ	A27		0,9	F54
	1.6 Bifuel	K4M 866	81/110	02.2009		RFN 58 LZ (b)	A7	B28	0,9	F54
	1.6 Bifuel	K4M 866	81/110	02.2009		RFN 58 LZ3A (g)	A515		0,9	
	2.0 16V	M4R 711	103/140	02.2009		RWC 58 HSE5DP	A528		1,15	
KADJAR (HA_, HL_) NEW	1.2 TCe 130	H5F 408	96/130	06.2015		RWN 42 HSIPS	A542		0,75	
KANGOO (KCO/1_)	1.0 i	D7D	43/58	10.1997		RFC 58 LZ2E	A10	B31	0,9	F54
	1.2 i	D7F 710-720-722-726-744-764	44/60	10.1997	04.2000	RFC 58 LZ2E	A10	B31	0,9	F54
	1.2 i	D7F - Euro 2000	44/60	05.2000		RFC 58 LZP	A178		0,9	F54

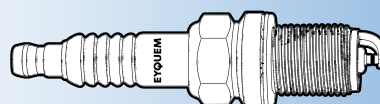

(1) Available until end of stock

- (a) 30 000 km
- (b) 60 000 km
- (c) Grey sticker on ignition coil
- (d) Green sticker on ignition coil

- (e) Hex 21 mm
- (f) Hex 16 mm
- (g) Recommended for cold weather



Box
10

Blister
4



F3

RENAULT

	1.2 i 16V	D4F 712-714-716-730	55/75	06.2001		RWC 52 HSK	A197	B58	0,9	
	1.4	E7J 634-635-780, K7J 700-701	55/75	03.1998		RFN 58 LZ (b)	A7	B28	0,9	F54
	1.4 i	E7J	55/75	10.1997	11.2000	RFN 58 LZ (b)	A7	B28	0,9	F54
	1.4 i	K7J	55/75	10.2000		RFN 58 LZ (b)	A7	B28	0,9	F54
	1.4 i	E7J	55/75	10.1997	11.2000	RFN 58 LZ3A (g)	A515		0,9	
	1.4 i	K7J	55/75	10.2000		RFN 58 LZ3A (g)	A515		0,9	
	1.6 16v Bivalent	K4M 850	60/82	06.2005		RFC 58 LZ2E	A10	B31	0,9	F54
	1.6 16V, 4x4	K4M 750-752-753-706	70/95	06.2001		RFN 58 LZ (b)	A7	B28	0,9	F54
	1.6 16V, 4x4	K4M 750-752-753-706	70/95	06.2001		RFN 58 LZ3A (g)	A515		0,9	
	1.6 i	K7M 746	66/90			RFC 58 LZ2E	A10	B31	0,9	F54
	1.6 i 16V	K4M	81/110	04.1998		RFN 52 LZ	A27		0,9	F54
KANGOO Express (FC0/1_)	1.2 i	D7F 710-720-722- 726-744-764	44/60	08.1997		RFC 58 LZ2E	A10	B31	0,9	F54
	1.2 i	D7F - Euro 2000	44/60	05.2000		RFC 58 LZP	A178		0,9	F54
	1.2 i	D7F 764-766	44/60	07.1998	04.2000	RFC 58 LZ2E	A10	B31	0,9	F54
	1.2 i 16V	D4F 712-714-730	55/75	10.2001		RFN 58 LZ (b)	A7	B28	0,9	F54
	1.2 i 16V	D4F 712-714-730	55/75	10.2001		RFN 58 LZ3A (g)	A515		0,9	
	1.4	E7J 634-635-780, K7J 701	55/75	08.1997		RFN 58 LZ (b)	A7	B28	0,9	F54
	1.4	E7J 634-635-780, K7J 701	55/75	08.1997		RFN 58 LZ3A (g)	A515		0,9	
	1.6 16v Bivalent	K4M 850	60/82	06.2005		RFC 58 LZ2E	A10	B31	0,9	F54
	1.6 16V, 4x4	K4M 750-752-753	70/95	10.2001		RFN 58 LZ (b)	A7	B28	0,9	F54
	1.6 16V, 4x4	K4M 750-752-753	70/95	10.2001		RFN 58 LZ3A (g)	A515		0,9	
KANGOO Express (FW0/1_)	1.6	K7M 750	64/87	02.2008		RFC 58 LZ2E	A10	B31	0,9	F54
	1.6 16V LPG	K4M 834	72/98	02.2008		RFC 58 LZ2E	A10	B31	0,9	F54
	1.6 16V	K4M 830	78/106	02.2008		RFN 52 LZ	A27		0,9	F54
KANGOO / GRAND KANGOO (KW0/1_)	1.6	K7M 750	64/87	02.2008		RFC 58 LZ2E	A10	B31	0,9	F54
	1.6 16V	K4M 830-831	78/106	02.2008		RFN 52 LZ	A27		0,9	F54
	1.6 16V Hi- Flex	K4M 834-850	78/106	02.2008		RFC 58 LZ2E	A10	B31	0,9	F54
KANGOO BE BOP (KW0/1_)	1.6	K4M 830	78/106	02.2009		RFN 52 LZ	A27		0,9	F54
KOLEOS (HY_)	2.5	2TR 700-702-703	126/171	09.2008		RWC 58 HSE5DP	A528		1,15	
	2.5 4x4	2TR 700-702-703	126/171	09.2008		RWC 58 HSE5DP	A528		1,15	
KWID (BW)	NEW 0.8	B4A (BR08)	40/54	09.2015		RWC42HSEW	A555		0,9	
	NEW 1.0 Sce	B4D (BR10)	50/68	08.2016		RWC42HSEW	A555		0,9	
	NEW 1.0 Sce Flex	B4D (BR10)	51/70	06.2017		RWC42HSEW	A555		0,9	
LAGUNA I (B56_, 556_)	1.6 16V	K4M 720-724	79/107	05.1998	03.2001	RFN 58 LZ (b)	A7	B28	0,9	F54
	1.6 16V	K4M 720-724	79/107	05.1998	03.2001	RFN 58 LZ3A (g)	A515		0,9	
	1.6 i 16V	K4M	81/110	04.1998		RFN 52 LZ	A27		0,9	F54
	1.8 i	F3P 720-724-674-676	66/90	11.1993	03.2001	RC 52 LS	A9	B20	0,9	L65
	1.8 i	F3P 670-678	66/90	08.1995	03.2001	RC 52 LS	A9	B20	0,9	L65
	1.8 i	F3P 720-724	69/94	08.1995	03.2001	RC 52 LS	A9	B20	0,9	L65
	1.8 i 16V	F4P 760-770	88/120	04.1998	03.2001	RFN 58 LZ (b)	A7	B28	0,9	F54
	1.8 i 16V	F4P 760-770	88/120	04.1998	03.2001	RFN 58 LZ3A (g)	A515		0,9	
	2.0 i 16V	N7Q 700-704	102/139	06.1995	03.2001	RFC 52 LS3	A66		1,2	
	2.0 i 16V	N7Q 700-704	103/140	06.1995	02.2001	RFC 52 LS3	A66		1,2	
	2.0		70/95	11.1993	03.2001	RFN 58 LZ (b)	A7	B28	0,9	F54
	2.0		70/95	11.1993	03.2001	RFN 58 LZ3A (g)	A515		0,9	
	2.0 i	F3R 611-722-723-768	80-83-84-85/ 109-113-114-115	01.1994	03.2001	RC 52 LS	A9	B20	0,9	L65
	2.0 i 16V	F4R 780	102/139	09.1999	01.2001	RFN 58 LZ (b)	A7	B28	0,9	F54
	2.0 i 16V	F4R 780	102/139	09.1999	01.2001	RFN 58 LZ3A (g)	A515		0,9	
	3.0 24V	L7X 700-701	140/190	03.1997	03.2001	RFC 58 LZ2	A54		1	F54
	3.0 i V6	Z7X - Z7W	123/167	11.1993	03.2001	RFC 58 LS3	A16	B33	1,2	
LAGUNA I Nevada (K56_)	1.6 16V	K4M 720-724	79/107	11.1997	03.2001	RFN 58 LZ (b)	A7	B28	0,9	F54
	1.6 16V	K4M 720-724	79/107	11.1997	03.2001	RFN 58 LZ3A (g)	A515		0,9	
	1.8	F3P 670-678	66/90	09.1995	03.2001	RC 52 LS	A9	B20	0,9	L65
	1.8	F3P 720-724	69/94	09.1995	03.2001	RC 52 LS	A9	B20	0,9	L65
	1.8 i 16V	F4P 760	88/120	04.1998	03.2001	RFN 58 LZ (b)	A7	B28	0,9	F54
	1.8 i 16V	F4P 760	88/120	04.1998	03.2001	RFN 58 LZ3A (g)	A515		0,9	
	2.0	F3R 722-723	83/113	09.1995	03.2001	RC 52 LS	A9	B20	0,9	L65
	2.0	F3R 728-768	84/114	10.1998	01.2001	RC 52 LS	A9	B20	0,9	L65
	2.0 i 16V	N7Q 700-704	102/139	06.1995	03.2001	RFC 52 LS3	A66		1,2	

(1) Available until end of stock

(a) 30 000 km

(b) 60 000 km

(c) Grey sticker on ignition coil

(d) Green sticker on ignition coil

(e) Hex 21 mm

(f) Hex 16 mm

(g) Recommended for cold weather



EYQUEM



Box 10
Blister 4



F3

RENAULT

	2.0 i 16V	F4R 780	103/140	09.1999	03.2001	RFN 58 LZ (b)	A7	B28	0,9	F54
	2.0 i 16V	F4R 780	103/140	09.1999	03.2001	RFN 58 LZ3A (g)	A515		0,9	
	3.0 24V	L7X 700-701	140/190	03.1997	03.2001	RFC 58 LZ2	A54		1	F54
	3.0 i V6	Z7X 765	123/167	02.1996	03.2001	RFC 58 LS3	A16	B33	1,2	
LAGUNA II (BGO/1_)	1.6 16V	K4M 710-714	79/107	03.2001		RFN 58 LZ (b)	A7	B28	0,9	F54
	1.6 16V	K4M 710-714	79/107	03.2001		RFN 58 LZ3A (g)	A515		0,9	
	1.6 i 16V	K4M 716	82/112	03.2001		RFN 52 LZ	A27		0,9	F54
	1.8 16V	F4P 770-771-773-774-775	85-86/116-117	03.2001		RFN 58 LZ (b)	A7	B28	0,9	F54
	1.8 16V	F4P 770-771-773-774-775	85-86/116-117	03.2001		RFN 58 LZ3A (g)	A515		0,9	
	1.8 16V	F4P 770-773	88/120	03.2001		RFN 58 LZ (b)	A7	B28	0,9	F54
	1.8 16V	F4P 770-773	88/120	03.2001		RFN 58 LZ3A (g)	A515		0,9	
	1.8 16V	F4P 770-772	89/121	03.2001		RFN 58 LZ (b)	A7	B28	0,9	F54
	1.8 16V	F4P 770-772	89/121	03.2001		RFN 58 LZ3A (g)	A515		0,9	
	2.0 16V	F4R 714	98/133	08.2002		RFN 58 LZ (b)	A7	B28	0,9	F54
	2.0 16V	F4R 714	98/133	08.2002		RFN 58 LZ3A (g)	A515		0,9	
	2.0 16V	F4R 712-713-714-715	99/135	08.2002		RFN 58 LZ (b)	A7	B28	0,9	F54
	2.0 16V	F4R 712-713-714-715	99/135	08.2002		RFN 58 LZ3A (g)	A515		0,9	
	2.0 16V IDE	F5R 700-701	103/140	04.2001		RFN 42 HZP5	A512		1,1	
	2.0 16V Turbo	F4R 764-765-786-787	120/163	01.2003		RFN 58 LZDP	A519		0,95	
	2.0 16V	F4R 784-786-787	125/170	01.2005		RFN 58 LZDP	A519		0,95	
	2.0 16V	F4R 886-887	150/204	01.2005		RFN 58 LZDP	A519		0,95	
	3.0 24V	L7X 731	152/207	03.2001		RFN 42 HZDP5	A184		1,1	
LAGUNA II Nevada (KGO/1_)	1.6 16V	K4M 710-714	79/107	03.2001		RFN 58 LZ (b)	A7	B28	0,9	F54
	1.6 16V	K4M 710-714	79/107	03.2001		RFN 58 LZ3A (g)	A515		0,9	
	1.6 16V	K4M 716	82/112	02.2005		RFN 52 LZ	A27		0,9	F54
	1.8 i 16V	F4P 770-771-774-776	85/115	03.2001		RFN 58 LZ (b)	A7	B28	0,9	F54
	1.8 i 16V	F4P 770-771-774-776	85/115	03.2001		RFN 58 LZ3A (g)	A515		0,9	
	1.8 i 16V	F4P 770	86/117	03.2001		RFN 58 LZ (b)	A7	B28	0,9	F54
	1.8 i 16V	F4P 770	86/117	03.2001		RFN 58 LZ3A (g)	A515		0,9	
	1.8 16V	F4P 770-773	88/120	03.2001		RFN 58 LZ (b)	A7	B28	0,9	F54
	1.8 16V	F4P 770-773	88/120	03.2001		RFN 58 LZ3A (g)	A515		0,9	
	1.8 16V	F4P 770-774	89/121	03.2001		RFN 58 LZ (b)	A7	B28	0,9	F54
	1.8 16V	F4P 770-774	89/121	03.2001		RFN 58 LZ3A (g)	A515		0,9	
	2.0 16V	F4R 714-715	98/133	10.2004	09.2007	RFN 58 LZ (b)	A7	B28	0,9	F54
	2.0 16V	F4R 714-715	98/133	10.2004	09.2007	RFN 58 LZ3A (g)	A515		0,9	
	2.0 16V	F4R 712-713-714-715	99/135	08.2002		RFN 58 LZ (b)	A7	B28	0,9	F54
	2.0 16V	F4R 712-713-714-715	99/135	08.2002		RFN 58 LZ3A (g)	A515		0,9	
	2.0 16V IDE	F5R 700-701	103/140	04.2001		RFN 42 HZP5			0,95	
	2.0 16V Turbo	F4R 764-765-786-787	120/163	01.2003		RFN 58 LZDP	A519		0,95	
	2.0 16V	F4R 784-786-787	125/170	01.2005		RFN 58 LZDP	A519		0,95	
	2.0 16V	F4R 886-887	150/204	01.2005		RFN 58 LZDP	A519		0,95	
	3.0 24V	L7X 731	152/207	03.2001		RFN 42 HZDP5	A184		1,1	
LAGUNA III (BTO/1)	1.6 16V	K4M 824	81/110	10.2007		RFN 52 LZ	A27		0,9	F54
	2.0 16V	M4R 704	103/140	10.2007		RWC 58 HSE5DP	A528		1,15	
	2.0 16V Hi-Flex	M4R 726	103/140	10.2007		RWC 58 HSE5DP	A528		1,15	
	2.0 16V Turbo	F4R 811	125/170	10.2007		RFN 58 LZDP	A519		0,9	
	3.5 V6	V4Y 713	175/238	04.2008		RWC 58 HSE5DP	A528		1,15	
LAGUNA III Grandtour (KTO/1)	1.6 16V	K4M 824	81/110	10.2007		RFN 52 LZ	A27		0,9	F54
	2.0 16V	M4R 704	103/140	10.2007		RWC 58 HSE5DP	A528		1,15	
	2.0 16V Hi-Flex	M4R 704-726	103/140	10.2007		RWC 58 HSE5DP	A528		1,15	
	2.0 16V Turbo	F4R 811	125/170	10.2007		RFN 58 LZDP	A519		0,9	
	3.5 V6	V4Y 713	175/238	04.2008		RWC 58 HSE5DP	A528		1,15	
LAGUNA Coupé (DT0/1)	2.0 16V Turbo	F4R 811-F4RT 811	125/170	09.2008		RFN 58 LZDP	A519		0,9	
	3.5 V6	V4Y 713	175/238	09.2008		RWC 58 HSE5DP	A528		1,15	
LATITUDE (L70_)	2.0 16V	M4R 746	103/140	02.2011		RWC 58 HSE5DP	A528		1,15	
LOGAN I (LS_)	1.4	K7J 710	55/75	09.2004		RFC 58 LZ2E	A10	B31	0,9	F54
	1.6	K7M 710	64/87	09.2004		RFC 58 LZ2E	A10	B31	0,9	F54
	1.6	K4M 690	77/105	04.2007		RFN 58 LZ (b)	A7	B28	0,9	F54
	1.6	K4M 690	77/105	04.2007		RFN 58 LZ3A (g)	A515		0,9	
LOGAN I MCV (KS_)	1.4	K7J 710	55/75	10.2007		RFC 58 LZ2E	A10	B31	0,9	F54
	1.6	K7M 710	64/87	04.2007		RFC 58 LZ2E	A10	B31	0,9	F54
	1.6	K4M 697	77/105	04.2007		RFN 58 LZ (b)	A7	B28	0,9	F54
	1.6	K4M 697	77/105	04.2007		RFN 58 LZ3A (g)	A515		0,9	



(1) Available until end of stock

- (a) 30 000 km
- (b) 60 000 km
- (c) Grey sticker on ignition coil
- (d) Green sticker on ignition coil

- (e) Hex 21 mm
- (f) Hex 16 mm
- (g) Recommended for cold weather



Box
10

Blister
4



F3-1

RENAULT

LOGAN II	NEW 1.2 16V	D4F 732	55/75	11.2013		RWC 58 HSEW	A530		0,9		
MASTER I Bus (T_)	2.0	J5R 718	58/79	10.1986	07.1998	RC 52 LS	A9	B20	0,8	L65	
	2.0	829 731	59/80	08.1980	09.1986	RC 52 LS	A9	B20	0,8	L65	
	2.0	J5R 728	60/82	06.1985	10.1989	RC 52 LS	A9	B20	0,8	L65	
	2.2 i	J7T 782	67/91	09.1980	07.1998	RC 52 LJS	A62	B27	0,9	J65	
	2.2 i	J7T 788	67/91	02.1991	07.1998	C 42 LJS3	A77		1,2		
MASTER I Camionnette (T_)	2.0	J5R 718	58/79	10.1986	07.1998	RC 52 LS	A9	B20	0,8	L65	
	2.0	829 731	59/80	08.1980	10.1986	RC 52 LS	A9	B20	0,8	L65	
	2.0	829 730 - J5R 728	60/82	06.1985	10.1989	RC 52 LS	A9	B20	0,8	L65	
	2.2 i	J7T 782	67/91	08.1980	07.1998	RC 52 LJS	A62	B27	0,9	J65	
	2.0	J5R 728	58/79	10.1986	07.1998	RC 52 LS	A9	B20	0,8	L65	
MASTER I Camion Plate-forme (P_)	2.0	829 731	59/80	07.1980	06.1985	RC 52 LS	A9	B20	0,8	L65	
	2.0	829 730	59/80	10.1982	09.1986	RC 52 LS	A9	B20	0,8	L65	
	2.0	J5R 718	60/82	11.1989	07.1993	RC 52 LS	A9	B20	0,8	L65	
	2.0	J5R 716-728	60/82	11.1989	12.1995	RC 52 LS	A9	B20	0,8	L65	
	2.2 i	J7T 788	71/97	08.1993	02.1998	C 42 LJS3	A77		1,2		
	2.0	J5R 718	60/82	11.1989	07.1993	RC 52 LS	A9	B20	0,8	L65	
MEGANE I (BA0/1_)	1.4 Eco	E7J 624	52/71	01.1996	03.1999	RFN 52 LZ	A27		0,9	F54	
	1.4 e	E7J 626-764	55/75	01.1996	08.2003	RFN 52 LZ	A27		0,9	F54	
	1.4 i 16V	K4J 714-750	70/95	03.1999	08.2003	RFN 58 LZ (b)	A7	B28	0,9	F54	
	1.4 i 16V	K4J 714-750	70/95	03.1999	08.2003	RFN 58 LZ3A (g)	A515		0,9		
	1.6 i	K7M 720	55/75	01.1996	03.1999	RFN 52 LZ	A27		0,9	F54	
	1.6 e	K7M 702-703-790	66/90	01.1996	03.1999	RFN 58 LZ (b)	A7	B28	0,9	F54	
	1.6 e	K7M 702-703-790	66/90	01.1996	03.1999	RFN 58 LZ3A (g)	A515		0,9		
	1.6 i 16V	K4M 700-701-704-708	79/107	03.1999	08.2003	RFN 58 LZ (b)	A7	B28	0,9	F54	
	1.6 i 16V	K4M 700-701-704-708	79/107	03.1999	08.2003	RFN 58 LZ3A (g)	A515		0,9		
	1.8 i 16V	F4P 720-722	85/115	01.2001	08.2003	RFN 58 LZ (b)	A7	B28	0,9	F54	
	1.8 i 16V	F4P 720-722	85/115	01.2001	08.2003	RFN 58 LZ3A (g)	A515		0,9		
	2.0 i	F3R 750-751	80/109	03.1999	08.2003	RC 52 LS	A9	B20	0,9	L65	
	2.0 i	F3R 750-751	84/114	01.1996	08.2003	RC 52 LS	A9	B20	0,9	L65	
	2.0 i 16V	F7R 710-714	108/147	12.1995	08.2003	RFC 58 LS3	A16	B33	1,2		
	MEGANE I Classic (LA0/1_)	1.4	E7J 626-764	55/75	09.1996	08.2003	RFN 52 LZ	A27		0,9	F54
1.4 i 16V		K4J 714-750	70/95	03.1999	08.2003	RFN 58 LZ (b)	A7	B28	0,9	F54	
1.4 i 16V		K4J 714-750	70/95	03.1999	08.2003	RFN 58 LZ3A (g)	A515		0,9		
1.6 i		K7M 720	55/75	09.1996	03.1999	RFN 52 LZ	A27		0,9	F54	
1.6 e		K7M 702-703-790	66/90	09.1996	03.1999	RFN 58 LZ (b)	A7	B28	0,9	F54	
1.6 e		K7M 702-703-790	66/90	09.1996	03.1999	RFN 58 LZ3A (g)	A515		0,9		
1.6 i 16V		K4M 700-701-704-708	79/107	03.1999	08.2003	RFN 58 LZ (b)	A7	B28	0,9	F54	
1.6 i 16V		K4M 700-701-704-708	79/107	03.1999	08.2003	RFN 58 LZ3A (g)	A515		0,9		
1.8 i 16V		F4P 720-722	85/115	01.2001	08.2003	RFN 58 LZ (b)	A7	B28	0,9	F54	
1.8 i 16V		F4P 720-722	85/115	01.2001	08.2003	RFN 58 LZ3A (g)	A515		0,9		
2.0 i		F3R 750-751	80/109	03.1999	08.2003	RC 52 LS	A9	B20	0,9	L65	
2.0 i		F3R 750-751-752-796-797-798	84/114	09.1996	08.2003	RC 52 LS	A9	B20	0,9	L65	
MEGANE I Break (KA0/1_)		1.4 e	E7J 624	55/75	03.1999	08.2003	RFN 52 LZ	A27		0,9	F54
		1.4 i 16V	K4J 714-750	70/95	03.1999	08.2003	RFN 58 LZ (b)	A7	B28	0,9	F54
		1.4 i 16V	K4J 714-750	70/95	03.1999	08.2003	RFN 58 LZ3A (g)	A515		0,9	
	1.6 e	K7M 702-703	66/90	03.1999	08.2003	RFN 58 LZ (b)	A7	B28	0,9	F54	
	1.6 e	K7M 702-703	66/90	03.1999	08.2003	RFN 58 LZ3A (g)	A515		0,9		
	1.6 i 16V	K4M 700-701-704-708	79/107	03.1999	08.2003	RFN 58 LZ (b)	A7	B28	0,9	F54	
	1.6 i 16V	K4M 700-701-704-708	79/107	03.1999	08.2003	RFN 58 LZ3A (g)	A515		0,9		
	1.8 i 16V	F4P 720-722	85/115	01.2001	08.2003	RFN 58 LZ (b)	A7	B28	0,9	F54	
	1.8 i 16V	F4P 720-722	85/115	01.2001	08.2003	RFN 58 LZ3A (g)	A515		0,9		
	2.0 i	F3R 750-751	80/109	03.1999	08.2003	RC 52 LS	A9	B20	0,9	L65	
MEGANE I Cabriolet (EA0/1_)	1.4 i 16V	K4J 714-750	70/95	03.1999	08.2003	RFN 58 LZ (b)	A7	B28	0,9	F54	
	1.4 i 16V	K4J 714-750	70/95	03.1999	08.2003	RFN 58 LZ3A (g)	A515		0,9		
	1.6 e	K7M 702-703-790	66/90	10.1996	03.1999	RFN 58 LZ (b)	A7	B28	0,9	F54	
	1.6 e	K7M 702-703-790	66/90	10.1996	03.1999	RFN 58 LZ3A (g)	A515		0,9		
	1.6 i 16V	K4M 700-701-708	79/107	03.1999	08.2003	RFN 58 LZ (b)	A7	B28	0,9	F54	
	1.6 i 16V	K4M 700-701-708	79/107	03.1999	08.2003	RFN 58 LZ3A (g)	A515		0,9		
	2.0 i	F3R 750-798	84/114	04.1997	08.2003	RC 52 LS	A9	B20	0,9	L65	
	2.0 i	F3R 791-796	80/109	03.1999	08.2003	RC 52 LS	A9	B20	0,9	L65	

(1) Available until end of stock

(a) 30 000 km

(b) 60 000 km

(c) Grey sticker on ignition coil

(d) Green sticker on ignition coil

(e) Hex 21 mm

(f) Hex 16 mm

(g) Recommended for cold weather



EYQUEM



Box
10

Blister
4



F3 → 1

RENAULT

	2.0 16V	F4R 746-770	102/139	01.2001	08.2003	RFN 58 LZ (b)	A7	B28	0,9	F54
	2.0 16V	F4R 746-770	102/139	01.2001	08.2003	RFN 58 LZ3A (g)	A515		0,9	
NEW	2.0 16V IDE	F5R 740-F4R 746	103/140	11.1999	08.2003	RFN 42 HZP5	A512		1,1	
	2.0 16V	F7R 710-714	108/147	03.1996	11.1999	RFC 58 LS3	A16	B33	1,2	
MEGANE I Coupé (DAO/1_)	1.4 i 16V	K4J 714-750	70/95	03.1999	08.2003	RFN 58 LZ (b)	A7	B28	0,9	F54
	1.4 i 16V	K4J 714-750	70/95	03.1999	08.2003	RFN 58 LZ3A (g)	A515		0,9	
	1.6 e	K7M 702-703	66/90	03.1996	03.1999	RFN 58 LZ (b)	A7	B28	0,9	F54
	1.6 e	K7M 702-703	66/90	03.1996	03.1999	RFN 58 LZ3A (g)	A515		0,9	
	1.6 i 16V	K4M 700-701-708	79/107	03.1999	08.2003	RFN 58 LZ (b)	A7	B28	0,9	F54
	1.6 i 16V	K4M 700-701-708	79/107	03.1999	08.2003	RFN 58 LZ3A (g)	A515		0,9	
	2.0 i	F3R 791-796	80/109	03.1999	08.2003	RC 52 LS	A9	B20	0,9	L65
	2.0 i	F3R 750-751-798	84/114	03.1996	08.2003	RC 52 LS	A9	B20	0,9	L65
	2.0 16V	F4R 746	102/139	01.2002	10.2002	RFN 58 LZ (b)	A7	B28	0,9	F54
	2.0 16V	F4R 746	102/139	01.2002	10.2002	RFN 58 LZ3A (g)	A515		0,9	
NEW	2.0 16V IDE	F5R 740	103/140	11.1999	08.2003	RFN 42 HZP5	A512		1,1	
	2.0 16V	F7R 710-714	108/147	03.1996	11.1999	RFC 58 LS3	A16	B33	1,2	
MEGANE II (BMO/1_ , CMO/1_)	1.4 16V	K4J 732	60/82	10.2003	02.2008	RFN 58 LZ (b)	A7	B28	0,9	F54
	1.4 16V	K4J 732	60/82	10.2003	02.2008	RFN 58 LZ3A (g)	A515		0,9	
	1.4 16V	K4J 730-740	72/98	11.2002	02.2008	RFN 58 LZ (b)	A7	B28	0,9	F54
	1.4 16V	K4J 730-740	72/98	11.2002	02.2008	RFN 58 LZ3A (g)	A515		0,9	
	1.4 i 16V	K4J	69/94			RFN 58 LZ (b)	A7	B28	0,9	F54
	1.4 i 16V	K4J	69/94			RFN 58 LZ3A (g)	A515		0,9	
	1.6 Bifuel	K4M 788	77/105	06.2005	02.2008	RFC 58 LZ2E	A10	B31	0,9	F54
	1.6	K4M 788	77/105	06.2005	02.2008	RFN 58 LZ (b)	A7	B28	0,9	F54
	1.6	K4M 788	77/105	06.2005	02.2008	RFN 58 LZ3A (g)	A515		0,9	
	1.6 Flex-Fuel	K4M 788	77/105	01.2007	02.2008	RFN 58 LZ (b)	A7	B28	0,9	F54
	1.6 Flex-Fuel	K4M 788	77/105	01.2007	02.2008	RFN 58 LZ3A (g)	A515		0,9	
	1.6 i 16V	K4M 760-812-813	82/112	01.2006	06.2008	RFN 52 LZ	A27		0,9	F54
	1.6 i 16V	K4M 760	83/113	11.2002	02.2008	RFN 52 LZ	A27		0,9	F54
	2.0 16V	F4R 770	99/135	11.2002	02.2008	RFN 58 LZ (b)	A7	B28	0,9	F54
	2.0 16V	F4R 770	99/135	11.2002	02.2008	RFN 58 LZ3A (g)	A515		0,9	
	2.0 i 16V	F4R	100-103/136-140	11.2002		RFN 58 LZ (b)	A7	B28	0,9	F54
	2.0 i 16V	F4R	100-103/136-140	11.2002		RFN 58 LZ3A (g)	A515		0,9	
	2.0 16V Turbo	F4R 776	120/163	05.2004	02.2008	RFN 58 LZDP	A519		0,9	
MEGANE II Break (KMO/1_)	1.4 16V	K4J 730-740	72/98	08.2003	07.2009	RFN 58 LZ (b)	A7	B28	0,9	F54
	1.4 16V	K4J 730-740	72/98	08.2003	07.2009	RFN 58 LZ3A (g)	A515		0,9	
	1.6 16V Hi-Flex	K4M 856	77/105	02.2008	07.2009	RFN 58 LZ (b)	A7	B28	0,9	F54
	1.6 16V Hi-Flex	K4M 856	77/105	02.2008	07.2009	RFN 58 LZ3A (g)	A515		0,9	
	1.6 i 16V	K4M 760-761-812-813	82/112	01.2006	08.2009	RFN 52 LZ	A27		0,9	F54
	1.6 i 16V	K4M 760-761	83/113	08.2003	07.2009	RFN 52 LZ	A27		0,9	F54
	2.0 16V	F4R 770-771	99/135	08.2003	07.2009	RFN 58 LZ (b)	A7	B28	0,9	F54
	2.0 16V	F4R 770-771	99/135	08.2003	07.2009	RFN 58 LZ3A (g)	A515		0,9	
MEGANE II Classic (LMO/1_)	1.4 16V	K4J 732	60/82	09.2003		RFN 58 LZ (b)	A7	B28	0,9	F54
	1.4 16V	K4J 732	60/82	09.2003		RFN 58 LZ3A (g)	A515		0,9	
	1.4 16V	K4J 730-740	72/98	09.2003		RFN 58 LZ (b)	A7	B28	0,9	F54
	1.4 16V	K4J 730-740	72/98	09.2003		RFN 58 LZ3A (g)	A515		0,9	
	1.6	K4M 762	77/105	05.2005		RFN 58 LZ (b)	A7	B28	0,9	F54
	1.6	K4M 762	77/105	05.2005		RFN 58 LZ3A (g)	A515		0,9	
	1.6 i 16V	K4M 812-813	82/112	01.2006		RFN 52 LZ	A27		0,9	F54
	1.6 i 16V	K4M 760-761	83/113	09.2003		RFN 52 LZ	A27		0,9	F54
	2.0 16V	F4R 770-771	99/135	09.2003		RFN 58 LZ (b)	A7	B28	0,9	F54
	2.0 16V	F4R 770-771	99/135	09.2003		RFN 58 LZ3A (g)	A515		0,9	
MEGANE II Coupé-Cabriolet (EMO/1_)	1.6 i 16V	K4M 788	77/105	06.2005	03.2009	RFN 58 LZ (b)	A7	B28	0,9	F54
	1.6 i 16V	K4M 788	77/105	06.2005	03.2009	RFN 58 LZ3A (g)	A515		0,9	
	1.6 i 16V	K4M 760-761-812-813	82/112	01.2006	08.2009	RFN 52 LZ	A27		0,9	F54
	1.6 i 16V	K4M 760-761	83/113	09.2003	03.2009	RFN 52 LZ	A27		0,9	F54
	2.0 16V	F4R 770-771	99/135	09.2003	12.2009	RFN 58 LZ (b)	A7	B28	0,9	F54
	2.0 16V	F4R 770-771	99/135	09.2003	12.2009	RFN 58 LZ3A (g)	A515		0,9	
	2.0 16V Turbo	F4R 776	120/163	05.2004	03.2009	RFN 58 LZDP	A519		0,9	
MEGANE III (BZO) NEW	1.2 TCe	H5F 400	85/116	03.2012		RWN 42 HSIPS	A542		0,75	

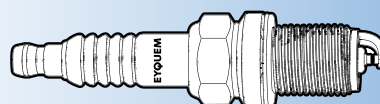

(1) Available until end of stock

- (a) 30 000 km
- (b) 60 000 km
- (c) Grey sticker on ignition coil
- (d) Green sticker on ignition coil

- (e) Hex 21 mm
- (f) Hex 16 mm
- (g) Recommended for cold weather



KW/HP



Box
10

Blister
4



F3

RENAULT

	1.4 TCE	H4J 700	96/131	04.2009	RWC 62 HSDPS	A520		0,7		
	1.6 16V	K4M 848	74/101	11.2008	RFN 58 LZ (b)	A7	B28	0,9	F54	
	1.6 16V	K4M 848	74/101	11.2008	RFN 58 LZ3A (g)	A515		0,9		
	1.6 16V	K4M 858	81/110	11.2008	RFN 52 LZ	A27		0,9	F54	
	1.6 16V Bifuel	K4M 866	81/110	11.2008	RFN 58 LZ (b)	A7	B28	0,9	F54	
	1.6 16V Bifuel	K4M 866	81/110	11.2008	RFN 58 LZ3A (g)	A515		0,9		
	1.6 16V	K4M 858-866	82/112	11.2008	RFN 52 LZ	A27		0,9	F54	
	2.0 CVT	M4R 711-713	103/140	02.2009	RWC 58 HSE5DP	A528		1,15		
	2.0 TCe	F4R 870	132/180	11.2008	RFN 58 LZDP	A519		0,9		
	2.0 TCe	F4R 872	140/190	06.2012	RFN 58 LZDP	A519		0,9		
MEGANE III Coupé (DZ0/1_)	NEW 1.2 TCe	H5F 400	85/116	03.2012	RWN 42 HSIPS	A542		0,75		
	1.4 TCe	H4J 700	96/131	04.2009	RWC 62 HSDPS	A520		0,7		
	1.6 16V	K4M 848	74/101	11.2008	RFN 58 LZ (b)	A7	B28	0,9	F54	
	1.6 16V	K4M 848	74/101	11.2008	RFN 58 LZ3A (g)	A515		0,9		
	1.6 16V	K4M 858	81/110	11.2008	RFN 52 LZ	A27		0,9	F54	
	1.6 16V Bifuel	K4M 866	81/110	11.2008	RFN 58 LZ (b)	A7	B28	0,9	F54	
	1.6 16V Bifuel	K4M 866	81/110	11.2008	RFN 58 LZ3A (g)	A515		0,9		
	2.0 CVT	M4R 711	103/140	05.2009	RWC 58 HSE5DP	A528		1,15		
	2.0 TCe	F4R 870	132/180	11.2008	RFN 58 LZDP	A519		0,9		
	2.0 TCe	F4R 872	140/190	06.2012	RFN 58 LZDP	A519		0,9		
MEGANE III CC (EZ0/1_)	1.4 TCe	H4J 700	96/131	04.2009	RWC 62 HSDPS	A520		0,7		
	1.6 16V	K4M 858	81/110	06.2010	RFN 52 LZ	A27		0,9	F54	
	2.0 CVT	M4R 711-713	103/140	06.2010	RWC 58 HSE5DP	A528		1,15		
	2.0 TCe	F4R 870-872	132/180	06.2010	RFN 58 LZDP	A519		0,9		
MEGANE III Grandtour (KZ0/1_)	NEW 1.2 TCe	H5F 400	85/116	03.2012	RWN 42 HSIPS	A542		0,75		
	1.4 TCe	H4J 700	96/131	05.2009	RWC 62 HSDPS	A520		0,7		
	1.6 16V	K4M 848	74/101	05.2009	RFN 58 LZ (b)	A7	B28	0,9	F54	
	1.6 16V	K4M 848	74/101	05.2009	RFN 58 LZ3A (g)	A515		0,9		
	1.6 16V	K4M 858	81/110	05.2009	RFN 52 LZ	A27		0,9	F54	
	1.6 16V Bifuel	K4M 866	81/110	11.2008	RFN 58 LZ (b)	A7	B28	0,9	F54	
	1.6 16V Bifuel	K4M 866	81/110	11.2008	RFN 58 LZ3A (g)	A515		0,9		
	2.0 CVT	M4R 711-M4R F 713	103/140	05.2009	RWC 58 HSE5DP	A528		1,15		
	2.0 TCe	F4R 870-872	132/180	11.2008	RFN 58 LZDP	A519		0,9		
	2.0 TCe	F4R 872	140/190	09.2012	RFN 58 LZDP	A519		0,9		
MEGANE IV (B9MS)	NEW 1.2 TCe 100	H5F 408	74/100	11.2015	RWN 42 HSIPS	A542		0,75		
MEGANE IV (B9MR)	NEW 1.2 TCe 130	H5F 408	97/130	11.2015	RWN 42 HSIPS	A542		0,75		
MEGANE IV Grandtour (K9A/M_)	NEW 1.2 TCe 100	H5F 408	74/100	04.2016	RWN 42 HSIPS	A542		0,75		
	NEW 1.2 TCe 130	H5F 408	97/130	04.2016	RWN 42 HSIPS	A542		0,75		
	1.6 16V	H4M738	84/115	04.2016	RWC 58 HSE5DP	A528		1,15		
MEGANE Scenic (JA0/1_)	1.4 e	E7J	55/75	10.1996	RFC 52 LS	A3	B16	0,8	F54	
	1.4 i	E7J 764	55/75	01.1997	09.1999	RFN 52 LZ	A27	0,9	F54	
	1.4 16V	K4J 714-750	70/95	09.1999	RFN 52 LZ	A27		0,9	F54	
	1.6 i	K7M 720	55/75	01.1997	09.1999	RFN 52 LZ	A27	0,9	F54	
	1.6 e	K7M 702-703-720	66/90		09.1998	RFC 52 LS	A3	B16	0,8	F54
	1.6 e	K7M 702-703	66/90	01.1997	09.1999	RFN 52 LZ	A27	0,9	F54	
		Mot.Nr. 981016 -->								
	1.6 16V	K4M 700-701-704-708	79/107	04.1998	10.1999	RFN 58 LZ (b)	A7	B28	0,9	F54
	1.6 16V	K4M 700-701-704-708	79/107	04.1998	10.1999	RFN 58 LZ3A (g)	A515		0,9	
	2.0 i	F3R 796	82/112	01.1999	09.1999	RFN 58 LZ (b)	A7	B28	0,9	F54
	2.0 i	F3R 796	82/112	01.1999	09.1999	RFN 58 LZ3A (g)	A515		0,9	
	2.0 i	F3R 750-751	84/114	01.1997	09.1999	RC 52 LS	A9	B20	0,9	L65
MEGANE SCENIC I	1.6 i 16V	K4M	79/107	08.1998	RFN 58 LZ (b)	A7	B28	0,9	F54	
	1.6 i 16V	K4M	79/107	08.1998	RFN 58 LZ3A (g)	A515		0,9		
	1.6 i 16V	K4M	81/110	08.1998	RFN 52 LZ	A27		0,9	F54	
	1.8 16V	F4P 720/F4P 722	85/115	01.2001	RFN 52 LZ	A27		0,9	F54	
	1.8 i 16V	F4P 720-722	85/115	01.2001	RFN 58 LZ (b)	A7	B28	0,9	F54	
	1.8 i 16V	F4P 720-722	85/115	01.2001	RFN 58 LZ3A (g)	A515		0,9		
	2.0 16V	F4R 740-741	102/138	07.2000	RFN 52 LZ	A27		0,9	F54	

(1) Available until end of stock

(a) 30 000 km

(b) 60 000 km

(c) Grey sticker on ignition coil

(d) Green sticker on ignition coil

(e) Hex 21 mm

(f) Hex 16 mm

(g) Recommended for cold weather

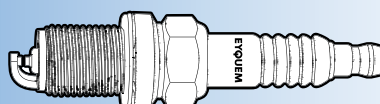

EYQUEM



Box
10

Blister
4



F3 → 1

RENAULT

	2.0 16V RX4	F4R 744	102/138	06.2000		RFN 52 LZ	A27		0,9	F54
	2.0 i	F3R 750-751-791-796-797-798	85/115	10.1996		RC 52 LS	A9	B20	0,8	L65
	2.0 i 16V	F4R	103/140	09.1999		RFN 58 LZ (b)	A7	B28	0,9	F54
	2.0 i 16V	F4R	103/140	09.1999		RFN 58 LZ3A (g)	A515		0,9	
MEGANE SCENIC II	1.4	K4J 730 - 740	72/98	06.2003		RFN 52 LZ	A27		0,9	F54
	1.4 i 16V	K4J	69/94	05.2003		RFN 58 LZ (b)	A7	B28	0,9	F54
	1.4 i 16V	K4J	69/94	05.2003		RFN 58 LZ3A (g)	A515		0,9	
	1.6	K4M 761/K4M 782	83/113	06.2003		RFN 52 LZ	A27		0,9	F54
	1.6 i 16V	K4M	81/110	05.2003		RFN 52 LZ	A27		0,9	F54
	2.0	F4R 770/F4R 771	99/135	06.2003		RFN 52 LZ	A27		0,9	F54
	2.0 i 16V	F4R	103/140	05.2003		RFN 58 LZ (b)	A7	B28	0,9	F54
	2.0 i 16V	F4R	103/140	05.2003		RFN 58 LZ3A (g)	A515		0,9	
MODUS / GRAND MODUS (F/JPO_)	1.2 i 16V	D4F 740	48/65	05.2005		RWC 52 HSK	A197	B58	0,9	
	1.2 i 16V	D4F 740	55/75	12.2004		RWC 52 HSK	A197	B58	0,9	
	1.2 Hi-Flex	D4F 740	55/75	10.2008		RWC 52 HSK	A197	B58	0,9	
	1.2	D4F 764	58/79	12.2004		RWC 52 HSK	A197	B58	0,9	
	1.2 16V	D4F 784	74/101	05.2007		RWC 62 HSDPS	A520		0,7	
NEW	1.2	D4F 786	76/103	04.2011		RWC 58 HSEW	A530		0,9	
	1.4	K4J 770-780	72/98	12.2004		RFN 58 LZ (b)	A7	B28	0,9	F54
	1.4	K4J 770-780	72/98	12.2004		RFN 58 LZ3A (g)	A515		0,9	
	1.4 i 16V	K4J	70/95	01.2004		RFN 58 LZ (b)	A7	B28	0,9	F54
	1.4 i 16V	K4J	70/95	01.2004		RFN 58 LZ3A (g)	A515		0,9	
	1.6	K4M 794	65/88	12.2004		RFN 58 LZ (b)	A7	B28	0,9	F54
	1.6	K4M 794	65/88	12.2004		RFN 58 LZ3A (g)	A515		0,9	
	1.6 i 16V	K4M 790-791-800-801	82-83/110-113	01.2004		RFN 52 LZ	A27		0,9	F54
RODEO 4	0.8	800 01	25/34	08.1971	11.1981	C 42 S	A12	B7	0,6	N43
	1.1	688 712	35/48	11.1981	12.1987	C 42 S	A12	B7	0,6	N43
RODEO 6	0.8	800 02	25/34	05.1970	08.1973	C 42 S	A12	B7	0,6	N43
	1.1	688 10	35/48	08.1973	11.1981	C 42 S	A12	B7	0,6	N43
SAFRANE I (B54_)	2.0 i	J7R 732-733	77/105	11.1992	09.1996	C 52 LJS	A23		0,9	J65
	2.0 i 12V	J7R 734-735-738-739	97/132	04.1992	09.1996	RFC 62 LS3	A56		1,2	
	2.2	J7T 760-761	101/137	04.1992	07.1996	RFC 62 LS3	A56		1,2	
	2.2 i	J7T 762-763	79/107	04.1992	09.1996	C 52 LJS	A23		0,9	J65
	2.2 i 12V	J7T 760-761	103/140	04.1992	09.1996	RFC 62 LS3	A56		1,2	
	3.0 V6	Z7X 721-722-723-753	123/167	12.1992	07.1996	RFC 58 LS3	A16	B33	1,2	
	3.0 i V6	Z7X 723-775	123-125/167-170	04.1992	09.1996	RFC 58 LS3	A16	B33	1,2	
	3.0 Biturbo 4x4	Z7X 726	193/262	02.1993	07.1996	FC 82 LS 3	A84		1,05	
SAFRANE II (B54_)	2.0 i 16V	N7Q 710-711	100/136	10.1996	12.2000	RFC 52 LS3	A66		1,2	
	2.5 i 20V	N7U 700-701	121/165	10.1996	07.2000	RFC 52 LS	A3	B16	0,9	F54
	2.9 24V	L7X 713	140/190	03.1999	12.2000	RFC 58 LZ2	A54		1	F54
	3.0 V6	Z7X 755	123/167	07.1996	12.2000	RFC 58 LS3	A16	B33	1,2	
SCÉNIC I (JA0/1_)	1.4	K4J 714-750	70/95	09.1999	08.2003	RFN 58 LZ (b)	A7	B28	0,9	F54
	1.4	K4J 714-750	70/95	09.1999	08.2003	RFN 58 LZ3A (g)	A515		0,9	
	1.6 16V	K4M 708-709	75/102	03.2001	08.2003	RFN 58 LZ (b)	A7	B28	0,9	F54
	1.6 16V	K4M 708-709	75/102	03.2001	08.2003	RFN 58 LZ3A (g)	A515		0,9	
	1.6 16V	K4M 700-706	79/107	09.1999	09.2003	RFN 58 LZ (b)	A7	B28	0,9	F54
	1.6 16V	K4M 700-706	79/107	09.1999	09.2003	RFN 58 LZ3A (g)	A515		0,9	
	1.8 16V	F4P 720-722	85/115	01.2001	08.2003	RFN 58 LZ (b)	A7	B28	0,9	F54
	1.8 16V	F4P 720-722	85/115	01.2001	08.2003	RFN 58 LZ3A (g)	A515		0,9	
	1.8 16V 4x4	F4P 722	86/117	07.2000	04.2001	RFN 58 LZ (b)	A7	B28	0,9	F54
	1.8 16V 4x4	F4P 722	86/117	07.2000	04.2001	RFN 58 LZ3A (g)	A515		0,9	
	2.0 16V RX4	F4R 744-746	102/139	06.2000	08.2003	RFN 58 LZ (b)	A7	B28	0,9	F54
	2.0 16V RX4	F4R 744-746	102/139	06.2000	08.2003	RFN 58 LZ3A (g)	A515		0,9	
	2.0 16V	F4R 740-741	102/139	07.2000	08.2003	RFN 58 LZ (b)	A7	B28	0,9	F54
	2.0 16V	F4R 740-741	102/139	07.2000	08.2003	RFN 58 LZ3A (g)	A515		0,9	
	2.0 16V	F4R 740-741-744-747	103/140	09.1999	08.2003	RFN 58 LZ (b)	A7	B28	0,9	F54
	2.0 16V	F4R 740-741-744-747	103/140	09.1999	08.2003	RFN 58 LZ3A (g)	A515		0,9	
SCÉNIC II (JM0/1_)	1.4	K4J 730 - 740	72/98	06.2003		RFN 58 LZ (b)	A7	B28	0,9	F54
	1.4	K4J 730 - 740	72/98	06.2003		RFN 58 LZ3A (g)	A515		0,9	
	1.6	K4M 788	77/105	06.2006		RFN 58 LZ (b)	A7	B28	0,9	F54
	1.6	K4M 788	77/105	06.2006		RFN 58 LZ3A (g)	A515		0,9	
	1.6 Hi-Flex	K4M 766	81/110	03.2005	07.2010	RFN 58 LZ (b)	A7	B28	0,9	F54
	1.6 Hi-Flex	K4M 766	81/110	03.2005	07.2010	RFN 58 LZ3A (g)	A515		0,9	

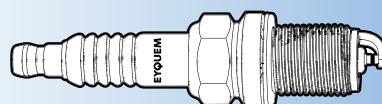

(1) Available until end of stock

- (a) 30 000 km
 (b) 60 000 km
 (c) Grey sticker on ignition coil
 (d) Green sticker on ignition coil

- (e) Hex 21 mm
 (f) Hex 16 mm
 (g) Recommended for cold weather



KW/HP



Box
10

Blister
4



F3-1

RENAULT

	1.6 16V	K4M 706-766-812-813	82/112	10.2005		RFN 52 LZ	A27	0,9	F54
	1.6 16V	K4M 761-782	83/113	06.2003		RFN 52 LZ	A27	0,9	F54
	2.0	F4R 770-771	99/135	06.2003		RFN 58 LZ (b)	A7 B28	0,9	F54
	2.0	F4R 770-771	99/135	06.2003		RFN 58 LZ3A (g)	A515	0,9	
	2.0 16V Turbo	F4R 776	120/163	05.2004		RFN 58 LZDP	A519	0,9	
SCÉNIC III (JZ0/1_)	NEW 1.2 TCe	H5F 400	85/116	04.2012		RWN 42 HSIPS	A542	0,75	
	1.4 16V	H4J 700	96/131	02.2009		RWC 62 HSDPS	A520	0,7	
	1.6 16V	K4M 858-K4M R 858	81/110	02.2009		RFN 52 LZ	A27	0,9	F54
	1.6 E85	K4M 866	81/110	02.2009		RFN 58 LZ (b)	A7 B28	0,9	F54
	1.6 E85	K4M 866	81/110	02.2009		RFN 58 LZ3A (g)	A515	0,9	
	2.0 16V	M4R 710-711	103/140	02.2009		RWC 58 HSE5DP	A528	1,15	
SCÉNIC IV (J9_)	NEW 1.2 TCe 115	H5F 408	85/115	09.2016		RWN 42 HSIPS	A542	0,75	
	NEW 1.2 TCe 130	H5F 408	96/130	09.2016		RWN 42 HSIPS	A542	0,75	
SG2, SG4	2.6				09.1986	C 32 S	A8 B3	0,6	N43
SPORT SPIDER (EF0_)	2.0 i 16V	F7R 710	108/147	12.1995	08.1996	RFC 58 LS3	A16 B33	1,2	
	2.0 i 16V	F7R 710	110/150	03.1995	10.1999	RFC 58 LS3	A16 B33	1,2	
SUPER 5 (B/C40_)	1.0	C1C 700	30/41	10.1984	05.1987	RC 52 LS	A9 B20	0,8	L65
	1.1	C1E 756-760	33/45	10.1984	12.1996	RC 32 LS	A49 B19	0,8	L3
	1.1	C1E 750-752-754	34/46	10.1984	10.1988	RC 52 LS	A9 B20	0,8	L65
	1.1	C1E 750	35/48	10.1989	12.1990	RC 52 LS	A9 B20	0,8	L65
	1.2	C1G 702-720	40/54	01.1987	08.1988	RC 52 LS	A9 B20	0,8	L65
	1.2	C1G 722	40/54	01.1987	08.1988	RC 32 LS	A49 B19	0,8	L3
	1.4	C1J 768-780	43/58	10.1984	06.1988	RC 52 LS	A9 B20	0,8	L65
	1.4 i	C3J 700-702-760	43/58	10.1984	12.1996	RC 52 LS	A9 B20	0,8	L65
	1.4	C2J 713	46/63	10.1980	12.1985	RC 62 LS	A6 B17	0,8	L65
	1.4 i	C2J 784	44/60	06.1987	08.1990	RC 52 LS	A9 B20	0,65	L65
	1.4 i	C2J 782	49/67	06.1987	07.1989	RC 52 LS	A9 B20	0,8	L65
	1.4 i	C2J 700-780-781-788-789-798	52/71	10.1984	07.1989	RC 52 LS	A9 B20	0,8	L65
	1.4 GTT	C1J 788	85/115	04.1985	10.1987	805 LP	A79	0,65	
	1.4 GT Turbo	C1J 782-784 -788	88/120	10.1984	12.1996	805 LP	A79	0,65	
	Turbo	840 730	118/160	01.1985	05.1991	883 LJP	A87	0,6	
	1.7	F3N 716-717	54/73	10.1986	03.1995	RC 62 LS	A6 B17	0,8	L65
	1.7	F2N 710-740	64/87	06.1987	12.1996	C 82 LS	A40 B6	0,8	L87
	1.7	F2N 740	66/90	09.1988	09.1990	C 82 LS	A40 B6	0,8	L87
	1.7 i	F3N 702-722	69/94	10.1986	12.1996	C 82 LS	A40 B6	0,8	L87
SUPER 5 Société (S40_)	1.0	C1C 700	30/41	10.1984	05.1987	RC 52 LS	A9 B20	0,8	L65
	1.1	C1E 750-752-754	34/46	10.1984	12.1996	RC 52 LS	A9 B20	0,8	L65
	1.2	C1G 702	44/60	01.1987	12.1996	RC 52 LS	A9 B20	0,8	L65
	1.4	C3J 700	44/60	09.1985	07.1986	RC 52 LS	A9 B20	0,8	L65
	1.4	C1J 788	85/115	04.1985	10.1987	805 LP	A79	0,65	
SYMBOL	1.2 16V	D4F 728	55/75	09.2008		RWC 52 HSK	A197 B58	0,9	
	1.6 16V	K4M 743	77/105	09.2008		RFN 58 LZ (b)	A7 B28	0,9	F54
	1.6 16V	K4M 743	77/105	09.2008		RFN 58 LZ3A (g)	A515	0,9	
THALIA I (LB0/1/2_)	1.2 16V	D4F 706-712	55/75	04.2002		RWC 52 HSK	A197 B58	0,9	
	1.4	K7J 700	55/75	08.2000		RFC 58 LZ2E	A10 B31	0,9	F54
	1.4 16V	K4J 712	72/98	08.2000		RFN 58 LZ (b)	A7 B28	0,9	F54
	1.4 16V	K4J 712	72/98	08.2000		RFN 58 LZ3A (g)	A515	0,9	
THALIA II (LU1/2_)	1.4	K7J700	55/75	09.2008	06.2014	RFC 58 LZ2E	A10 B31	0,9	F54
TWINGO I (C06_)	1.0 i	D7D	43/58			RFC 58 LZ2E	A10 B31	0,9	F54
	1.2	C3G 700-702	40/54	03.1993	06.1999	RC 32 LS	A49 B19	0,9	L3
	1.2	D7F 700-701	40/54	05.1996	06.1997	FN 52 LS	A41	0,9	F54
	1.2	--> Mot.Nr. 970620							
	1.2	D7F 700-701	40/54	05.1996	06.1997	RFN 52 LZ	A27	0,9	F54
	1.2	--> Mot.Nr. 970620							
	1.2	D7F 700-701	40/54	07.1997		RFC 58 LZ2E	A10 B31	0,9	F54
	1.2i	D7F 700-701-702-703-704-706	43/58	06.1996		RFC 58 LZ2E	A10 B31	0,9	F54
	1.2 LPG	D7F 702-708	44/60	10.2003		RFC 58 LZ2E	A10 B31	0,9	F54
	1.2i	D7F- Euro 2000	44/60	04.2000		RFC 58 LZP	A178	0,9	F54
	1.2i 16V	D4F 780	55/75	01.2001		RWC 52 HSK	A197 B58	0,9	
	1.2i 16V	D4F 702	55/75	01.2001		RWC 52 HSK	A197 B58	0,9	

(1) Available until end of stock

(a) 30 000 km

(b) 60 000 km

(c) Grey sticker on ignition coil

(d) Green sticker on ignition coil

(e) Hex 21 mm

(f) Hex 16 mm

(g) Recommended for cold weather



EYQUEM



Box
10

Blister
4



F3

RENAULT

TWINGO I Box (S06_)	1.2	D7F 700-701-702-703-704-706	43/58	05.1996	06.1997	FN 52 LS	A41		0,9	F54
	1.2	D7F 700-701-702-703-704-706	43/58	05.1996	06.1997	RFN 52 LZ	A27		0,9	F54
	1.2	D7F 700-701-702-703-704-706	43/58	07.1997		RFC 58 LZ2E	A10	B31	0,9	F54
	1.2	C3G 700-702	40/54	03.1993	05.1996	RC 32 LS	A49	B19	0,9	L3
TWINGO II (CNO_)	1.2	D7F 800	43/58	03.2007		RFC 58 LZ2E	A10	B31	0,9	F54
	1.2 16V	D4F 722	55/75	03.2007		RWC 52 HSK	A197	B58	0,9	
	1.2 16V	D4F 772	56/76	03.2007		RWC 52 HSK	A197	B58	0,9	
	1.2 16V	D4F 764-770-772	55/75	03.2007		RWC 52 HSK	A197	B58	0,9	
	1.2 TURBO	D4F 780-782-784	74/101	03.2007		RWC 62 HSDPS	A520		0,7	
	NEW 1.2 TCe 100	D4F 780-782	75/102	02.2011		RWC 58 HSEW	A530		0,9	
TWINGO III (BCM_)	NEW 0.9 TCe	H4B 401	66/90	09.2014		RWN 42 HSIPS	A542		0,75	
	NEW 1.0 SCe	H4D 400	52/71	09.2014		RWC 58 HSEW	A530		0,9	
	NEW 1.0 Sce 70	B4D	51/69	09.2015		RWC 42 HSEW	A555		0,9	
VEL SATIS (BJO_)	2.0 16 V Turbo	F4R 867	108/147	04.2004		RFN 58 LZDP	A519		0,9	
	2.0 16V Turbo (BJOK)	F4R 762-763	120/163	06.2002		RFN 58 LZDP	A519		0,9	
	2.0 16V Turbo	F4R 766-767	125/170	04.2004		RFN 58 LZDP	A519		0,9	
	NEW 3.5 V6	V4Y 701-711	177/241	06.2002		RFN 42 HZP5	A512		1,1	
WIND (E4M_)	1.2	D4F 782	74/101	07.2010		RWC 62 HSDPS	A520		0,7	
	1.2 TCe 100	D4F 780	75/102	02.2011		RWC 62 HSDPS	A520		0,7	
TRAFIC autobus (TXW)	1.7	F1N 724	50/68	08.1992	08.1994	C 82 LS	A40	B6	0,8	L87
	2.0	J5R 726	59/80	05.1989	08.1990	RC 52 LS	A9	B20	0,9	L65
	2.2	J7T 780	70/95	05.1989	06.1994	RC 52 LJS	A62	B27	0,8	J65
	2.2 i	J7T 600-624	74/101	06.1994	10.1997	C 42 LJS3	A77		1,2	
TRAFIC Bus (T5, T6, T7)	1.4 P.0	847 700-701- C1J 700	35/48	03.1980	04.1989	RC 52 LS	A9	B20	0,6	L65
	1.6, 4x4	A1M 707-708 - 841 705	48/65	01.1984	06.1986	RC 52 LS	A9	B20	0,6	L65
	1.7	F1N 720-722-724	50/68	06.1986	04.1989	C 82 LS	A40	B6	0,8	L87
	2.0	829 720	58/79	07.1980	04.1985	RC 52 LS	A9	B20	0,8	L65
	2.0, 4x4	J5R 716-722-726	59/80	06.1986	04.1989	RC 52 LS	A9	B20	0,9	L65
TRAFIC Camionnette (T1, T3, T4)	1.4	847 700-701- C1J 700	35/48	03.1980	04.1989	RC 52 LS	A9	B20	0,6	L65
	1.6, 4x4	A1M 707-708	48/65	01.1983	06.1986	RC 52 LS	A9	B20	0,6	L65
	1.7	F1N 724	50/68	06.1986	04.1989	C 82 LS	A40	B6	0,8	L87
	2.0	829 720	58/79	07.1980	04.1985	RC 52 LS	A9	B20	0,8	L65
	2.0, 4x4	J5R 716-722-726	59/80	06.1986	04.1989	RC 52 LS	A9	B20	0,9	L65
	2.0	J5R 716	60/82	05.1985	02.1989	RC 52 LS	A9	B20	0,9	L65
TRAFIC Camionnette (TXX)	1.4	C1J 700	35/48	05.1989	06.1991	RC 52 LS	A9	B20	0,6	L65
	1.7	F1N 720	50/68	08.1992	08.1994	C 82 LS	A40	B6	0,8	L87
	2.0	J5R 716	59/80	05.1989	08.1990	RC 52 LS	A9	B20	0,9	L65
	2.2, 4x4	J7T 780	70/95	05.1989	06.1994	RC 52 LJS	A62	B27	0,8	J65
	2.2, 4x4	J7T 600	74/101	06.1994	10.1997	C 42 LJS3	A77		1,2	
TRAFIC Camion Plate-forme(P6)	1.4	847 700- C1J 700	35/48	03.1980	04.1989	RC 52 LS	A9	B20	0,6	L65
	1.6	841 705- A1M 705	48/65	03.1980	06.1986	RC 52 LS	A9	B20	0,6	L65
	1.7	F1N 722	50/68	06.1986	04.1989	C 82 LS	A40	B6	0,8	L87
	2.0	J5R 726	59/80	03.1980	04.1989	RC 52 LS	A9	B20	0,9	L65
	2.0	829 720-721	63/86	03.1980	12.1986	RC 52 LS	A9	B20	0,8	L65
	2.0, 4x4	J5R 716	60/82	05.1985	02.1989	RC 52 LS	A9	B20	0,9	L65
TRAFIC Camion Plate-forme(PXX)	1.7	F1N 722	50/68	05.1989	08.1994	C 82 LS	A40	B6	0,8	L87
	2.0	J5R 726	59/80	05.1989	10.1997	RC 52 LS	A9	B20	0,9	L65
	2.0	J5R 726	60/82	03.1989	12.1991	RC 52 LS	A9	B20	0,9	L65
	2.2	J7T 780	70/95	05.1989	06.1994	RC 52 LJS	A62	B27	0,8	J65
	2.2, 4x4	J7T 600	74/101	09.1994	04.1998	C 42 LJS3	A77		1,2	
TRAFIC II bus (JL)	2.0 16V	F4R 820	86/117	08.2006		RFN 58 LZDP	A519		0,9	
	2.0 16V	F4R 720-722	88/120	03.2001		RFN 58 LZDP	A519		0,9	
TRAFIC II Camionnette (FL)	2.0 16V	F4R 820	86/117	08.2006		RFN 58 LZDP	A519		0,9	
	2.0 16V	F4R 720-722	88/120	03.2001		RFN 58 LZDP	A519		0,9	
TRAFIC II Camion Plate-forme (EL)	2.0 16V	F4R 820	86/117	08.2006		RFN 58 LZDP	A519		0,9	
	2.0 16V	F4R 720	88/120	03.2001		RFN 58 LZDP	A519		0,9	

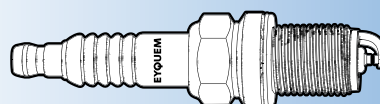

- (1) Available until end of stock
 (a) 30 000 km
 (b) 60 000 km
 (c) Grey sticker on ignition coil
 (d) Green sticker on ignition coil

- (e) Hex 21 mm
 (f) Hex 16 mm
 (g) Recommended for cold weather



KW/HP



Box
10

Blister
4



F3-1

ROLLS-ROYCE

CAMARGUE	6.8 V8		180-194/245-264	02.1980	06.1985	RC 32 LS	A49	B19	0,8	L3
CORNICHE	6.8 V8		180-194/245-264	02.1980	06.1985	RC 32 LS	A49	B19	0,8	L3
PHANTOM	6.2 V8					RC 32 LS	A49	B19	0,8	L3
SILVER CLOUD II, III	6.2 V8					RC 32 LS	A49	B19	0,8	L3
SILVER DAWN	6.8 V8		182/248		10.1997	RC 32 LS	A49	B19	0,8	L3
SILVER SHADOW	6.2 V8					RC 32 LS	A49	B19	0,8	L3
SILVER SPIRIT	6.8 V8	[OHV]	176-194/239-264		08.1988	RC 32 LS	A49	B19	0,8	L3
SILVER SPUR	6.8 V8	[OHV]	176-194/239-264		08.1988	RC 32 LS	A49	B19	0,8	L3
	6.8 V8 Turbo	[OHV]			10.1997	RC 32 LS	A49	B19	0,8	L3
SILVER WRAITH II	6.8 V8					RC 32 LS	A49	B19	0,8	L3

ROVER

25	1.4 16V	14 K4M --> Fgst.Nr. YD 471 564	62/84		10.1999	RFC 52 LS	A3	B16	0,8	F54	
	1.4 16V	14 K4F --> Fgst.Nr. YD 471 564	76/103		10.1999	RFC 52 LS	A3	B16	0,8	F54	
	1.6 16V	16 K4F --> Fgst.Nr. YD 471 564	80/109		10.1999	RFC 52 LS	A3	B16	0,8	F54	
	1.8 16V	18 K4F	85/115		10.1999	RFN 58 LZDP5	A187		1,1		
	1.8 16V	18 K4K	107/145		02.2000	RFN 58 LZDP5	A187		1,1		
45	1.4	14 K4F	76/103		02.2000	RFN 58 LZDP5	A187		1,1		
	1.6	16 K4F	80/109		02.2000	RFN 58 LZDP5	A187		1,1		
	1.8	18 K4F	86/117		02.2000	RFN 58 LZDP5	A187		1,1		
	2.0 V6	20 K4F	110/150		02.2000	RFN 58 LZDP5	A187		1,1		
75	1.8	K 1.8	88/120		02.1999	RFN 58 LZDP5	A187		1,1		
	1.8 Turbo		110/150		05.2003	RFN 58 LZDP5	A187		1,1		
	1.8 Turbo		110/150		05.2003	RFC 52 LZDP5	A149		1,1		
	2.0 V6	20 K4F	110/150		02.1999	RFN 58 LZDP5	A187		1,1		
	2.5 V6	KV 6	129/175		02.1999	10.2001	RFN 58 LZDP5	A187		1,1	
	2.5 V6	25 K4F	130/177		10.2001		RFN 58 LZDP5	A187		1,1	
100	111 : 1.1 Blue Jazz, Caribbean, Red Note, Sunbury, Wesley	11K series	44/60		05.1990		RFC 52 LS	A3	B16	0,8	F54
	111 : 1.1 C, L, LS, S, SL	11K series	44/60		05.1990		RFC 52 LS	A3	B16	0,8	F54
	114 : 1.4 i 16V GTi	K 16 series 14 K4C, 14 K4D, 14 K4F [DOHC]	66-76/90-103		05.1990		RFC 52 LS	A3	B16	0,8	F54
	114 : 1.4 SL, GS, GTa	14K series 14K2A, 14K2D	55-56/75-76		05.1990		RFC 52 LS	A3	B16	0,8	F54
200	213 : 1.3 EX, S, SE, SX, Vanden Plas, Sunbury	EV	54/73		06.1984	09.1990	RC 62 LS5	A24		1,1	L65-5
	214 : 1.4 i 16V GSi, Si, SLi, Cabrio, Sutton	K 16 series 14 K4C, 14 K4D, 14 K4F [DOHC]	66-76/90-103		10.1989		RFC 52 LS	A3	B16	0,9	F54
	214 : 1.4 i S	14K series 14K2F [SOHC]	55/75		09.1990	03.1996	RFC 52 LS	A3	B16	0,9	F54
	216 : 1.6 EX, SX, S, Sprint	S Series	63/86		03.1985	10.1992	RFC 52 LS	A3	B16	0,9	F54
	216 : 1.6 i 16V	16K series 16K4F [DOHC] Cat	82/112		11.1995		RFC 52 LS	A3	B16	0,9	F54
	216 : 1.6 i 16V GSi, Cabrio, Coupé	ZC [SOHC]	82-85/112-115		10.1989	11.1995	RFC 58 LS5	A38	B48	1,1	F54-5
	216 : 1.6 i 16V GTi Twin Cam, Cabrio, Saloon, Hatchback	ZC [DOHC]	90-96/122-131		03.1989	03.1996	RFC 58 LS5	A38	B48	1,1	F54-5
	216 : 1.6 i SE, Vanden Plas, Vitesse	S Series	75/102		03.1985	10.1992	RFC 52 LS	A3	B16	0,9	F54
	218 : 1.8 i 16V	18K4K	110/150		01.1996		RFN 58 LZ (b)	A7	B28	0,8	F54
	218 : 1.8 i 16V	18K4K	110/150		01.1996		RFN 58 LZ3A (g)	A515		0,8	
	218 K Vi	18 K4K	107/145		11.1995	03.2000	FN 58 LZDPR	A198		0,75	
	220 : 2.0 i 16V GTi	T16 [DOHC]	100/136		06.1991		RFC 52 LS	A3	B16	0,9	F54
	220 : 2.0 i 16V Turbo	T16 [DOHC]	147/200		06.1991		RFC 62 LS	A48		0,8	F86
400	414 : 1.4 i 16V Si, SLi, GSi	K 16 series 14K4F [DOHC]	76/103		01.1993		RFC 52 LS	A3	B16	0,8	F54
	414 : 1.4 i GSi	14K series [DOHC]	70/95		03.1990		RFC 52 LS	A3	B16	0,8	F54
	416 : 1.6 i 16V GSi	D6A	82-85/112-115		03.1990		RFC 58 LS5	A38	B48	1,1	F54-5
	416 : 1.6 i 16V GTi	ZC [DOHC]	90-96/122-131		03.1990		RFC 58 LS5	A38	B48	1,1	F54-5
	416 : 1.6 i 16V Si, SLi, Tourer	16K series 16K4F [DOHC] Cat	82/112		09.1995		RFC 52 LS	A3	B16	0,8	F54
	418 : 1.8 i 16V	18K4K	110/150		01.1996		RFN 58 LZ (b)	A7	B28	0,8	F54
	418 : 1.8 i 16V	18K4K	110/150		01.1996		RFN 58 LZ3A (g)	A515		0,8	
	420 : 2.0 i 16V Ti GSi, SLi, Sport, GTI	T16 - M16i [DOHC]	100-103/136-140		10.1991		RFC 52 LS	A3	B16	0,8	F54
	420 : 2.0 i 16V Turbo	T16 [DOHC]	147/200		11.1991		RFC 62 LS	A48		0,8	F86
400 Tourer (XW)	1.8 i	18 K4K	107/145		06.1996	11.1998	RFN 58 LZDP5	A187		1,1	
600	618 : 1.8 i 16V		85/115		09.1995	02.1999	RFC 52 LS	A3	B16	0,9	F54
	618 i/Si	F 18 A3	85/115		03.1996	02.1999	RFC 58 LZ5	A75		1,1	F54-5
	620 : 2.0 i 16V Turbo	T16 [DOHC]	147/200		04.1993	02.1999	RFC 52 LS	A3	B16	0,9	F54
	620 : 2.0 Si, Si Lux						RFC 32 LZ5	A117		1,1	
	620 i	F 20 Z2	85/115		08.1993	06.1996	RFC 58 LZ5	A75		1,1	F54-5
	620 Si	F 20 Z1	96/131		08.1993	02.1999	RFC 58 LZ5	A75		1,1	F54-5

(f) Available until end of stock

(a) 30 000 km

(b) 60 000 km

(c) Grey sticker on ignition coil

(d) Green sticker on ignition coil

(e) Hex 21 mm

(f) Hex 16 mm

(g) Recommended for cold weather

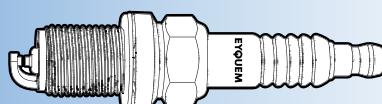

EYQUEM



Box
10

Blister
4



F3-1

ROVER										
	623 : 2.3 i 16V	H23 A2 [DOHC]	116/158	04.1993	02.1999	RFC 58 LZE5	A75		1,1	F54-5
	623 : 2.3 Si Lux					RFC 32 LZ5	A117		1,1	
800	820 : 2.0	O Series	74/101	03.1988	09.1990	RC 72 LS	A32	B26	0,8	L87
	820 : 2.0 i 16V	T16 [DOHC]	100-103/136-140	12.1991		RFC 52 LS	A3	B16	0,8	F54
	820 : 2.0 i 16V E, SE	M16E	88/120	10.1986	12.1991	RFC 52 LS	A3	B16	0,8	F54
	820 : 2.0 i 16V Si, Sli	M16 i [DOHC]	98-103/133-140	10.1986	12.1991	RFC 52 LS	A3	B16	0,8	F54
	820 : 2.0 i 16V Turbo	T16 [DOHC]	132-140/180-190	01.1992		RFC 62 LS	A48		0,8	F86
	825 : 2.5 i V6	K Series	129/175	01.1996	02.1999	RFC 58 LS	A18		0,8	F54
	825 : 2.5 i V6 Si, Sterling	C25A Cat	110-125-129/ 150-170-175	07.1986	12.1991	RFC 52 LS5	A26	B24	1,1	F54-5
	827 : 2.7 i S, SLi, Sterling, Vitesse	C27A	124-130/169-177	02.1988	12.1991	RFC 52 LS5	A26	B24	1,1	F54-5
	827 : 2.7 i Si, SLi, Sterling	C27A	124-130/169-177	01.1992	06.1996	RFC 52 LS5	A26	B24	1,1	F54-5
2000-3500	2000 : 2.0 SDi			06.1976	10.1986	RC 52 LJS	A62	B27	1,1	J65
	2300 : 2.3			06.1976	10.1986	RC 52 LJS	A62	B27	1,1	J65
	2600 : 2.6			06.1976	10.1986	RC 52 LJS	A62	B27	1,1	J65
	3500 : 3.5 i V8 S, SE, Vanden Plas, Vitesse			06.1976	10.1986	RC 62 LS	A6	B17	0,8	L65
ALLEGRO	1100, 1300, 1500, 1750			05.1973	03.1982	C 62 LS	A4	B5	0,7	L65
AMBASSADOR	1700, 2000			03.1982	12.1984	C 62 LJS	A19	B2	0,7	J65
COUPE	1.6 16 V		82/112	03.1996	11.1999	RFC 52 LS	A3	B16	0,8	F54
	1.8 16 V	18 K4K	107/145	03.1996	11.1999	RFN 58 LZDP5	A187		1,1	
ITAL	1.3 Estate	A Plus	45/61	07.1980	09.1984	C 62 LS	A4	B5	0,8	L65
	1.7	O Series	58/79	07.1980	09.1984	C 62 LJS	A19	B2	0,8	J65
	2.0			10.1980	10.1982	C 62 LJS	A19	B2	0,8	J65
MAESTRO	1.3 L, HLE, Van	A Series		03.1983	08.1988	C 62 LS	A4	B5	0,8	L65
	1.6	R Series	59/80			C 72 LS (1)	A30		0,8	L87
	1.6 L, HLS, Van	S Series	63/86	03.1983	08.1988	FC 58 LS	A14		0,9	F54
	1.6 MG	S Series TC	63/86	05.1984	08.1988	RFC 62 LS	A48		0,8	F86
	2.0 i	O Series	83/113	10.1984	08.1988	RC 72 LS	A32	B26	0,8	L87
	500/700 : 1.3 City L	12H				C 62 LS	A4	B5	0,8	L65
	500/700 : 1.6 City L	16H				FC 58 LS	A14		0,9	F54
MARINA	1300, 1800				12.1980	C 62 LS	A4	B5	0,7	L65
	1700 : 1.7				12.1980	C 62 LJS	A19	B2	0,7	J65
MAXI	1500, 1750, 1750 HL			04.1969	10.1981	C 62 LS	A4	B5	0,7	L65
	1.0 Chelsea, HLE, Kensington, Picadilly, Special, Van	A Series		10.1986	04.1990	RC 30 LS	A109		0,8	
	1.0 HLE, Van	A Series		10.1980	09.1986	RC 62 LS	A6	B17	0,8	L65
	1.3 Advantage, HLE, Jet Black, Red Hot, Sprite	A Series		10.1980	04.1990	RC 62 LS	A6	B17	0,8	L65
	1.3 Turbo	A Series	68/92	10.1983	04.1990	RC 72 LS	A32	B26	0,8	L87
	310 : 1.0 City L	99H				RC 62 LS	A6	B17	0,8	L65
	310 : 1.3 City L	12H				RC 62 LS	A6	B17	0,8	L65
MG RV8	3.9 i V8		140/190	09.1992	12.1995	RC 72 LS	A32	B26	0,8	L87
MINI	0.8 1.0, 1.1					RC 52 LS	A9	B20	0,7	L65
	1.3 Cooper, DeVille			02.1991		RC 62 LS	A6	B17	0,7	L65
	Cooper	W10B16A	85/115	06.2001		RFC 58 LZP4	A193		1,5	
	Cooper S	W11B16A	120/163	03.2002		RFC 58 LZP4	A193		1,5	
	One	W10B16A	66/90	06.2001		RFC 58 LZP4	A193		1,5	
MINI VAN	1.0	A Series			12.1983	RC 62 LS	A6	B17	0,8	L65
MONTEGO	1.3	A Series	51/69	04.1984	10.1985	C 62 LS	A4	B5	0,8	L65
	1.6 Estate, S	S Series	61-63/83-86	04.1984	08.1988	FC 52 LS	A2	B9	0,9	F54
	2.0	O Series	77/105	04.1984	08.1988	C 62 LS	A4	B5	0,8	L65
	2.0 i Turbo Estate, MG, Turbo	O Series Turbo	83-110/113-150	04.1984	08.1988	RC 72 LS	A32	B26	0,8	L87
PICK-UP	1.0	A Series			12.1983	RC 62 LS	A6	B17	0,8	L65
PRINCESS	1.7 Princess II HL				12.1981	C 62 LJS	A19	B2	0,7	J65
	1100, 1300				12.1983	C 62 LS	A4	B5	0,7	L65
	1800 : 1.8				12.1983	C 62 LS	A4	B5	0,7	L65
	2.0 Princess II				12.1981	C 62 LJS	A19	B2	0,7	J65
	2200 : 2.2				12.1983	C 62 LS	A4	B5	0,7	L65
VANDEN PLAS	1300, 1500, 1750				12.1981	RC 62 LS	A6	B17	0,7	L65

SAAB										
90	2.0	B 201...C	74/101	08.1984	08.1987	C 62 LS	A4	B5	0,7	L65
95	1.5	Ford V4 thread 19 mm	48/65		12.1980	C 62 LS	A4	B5	0,8	L65
	1.5	Ford V4 thread 12,7 mm	48/65		12.1980	C 62 S	A55		0,8	

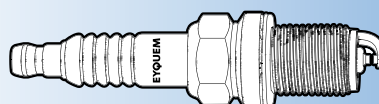

(1) Available until end of stock
 (a) 30 000 km
 (b) 60 000 km
 (c) Grey sticker on ignition coil
 (d) Green sticker on ignition coil

(e) Hex 21 mm
 (f) Hex 16 mm
 (g) Recommended for cold weather



KW/HP



Box
10

Blister
4



F3-1

SAAB

99	2.0	F 201 C - BT20 - B20	73-74/99-100		12.1984	C 62 LS	A4	B5	0,7	L65	
	2.0 EMS	B120			12.1981	C 62 LS	A4	B5	0,7	L65	
	2.0 GL	B 20			12.1984	C 62 LS	A4	B5	0,7	L65	
	2.0 Turbo	BS120			12.1980	C 82 LS	A40	B6	0,7	L87	
900	1.5 GLE	Ford V4	48/65		12.1986	RC 62 LS	A6	B17	0,8	L65	
	16 : 2.0 i, Cabrio	B 202...I Cat	92-98/125-133	09.1985	08.1991	FC 42 LS	A15	B14	0,8	F54	
	16 : 2.0 Turbo, Turbo Cabrio	B 202...L Cat	104-118-132/ 141-160-180	02.1984	08.1993	RFC 82 LS5	A65		1,0		
	16 : 2.1 i 16v, Cabrio	B 212...I Cat	100-103/136-140	09.1990	08.1991	FC 42 LS	A15	B14	0,8	F54	
	2.0 -16	B202I	93/126	01.1989	08.1991	RFC 42 LS5	A83		1,1	F54-5	
	2.0 -16 Turbo	B204L	136/185	07.1993	02.1998	RFC 82 LS	A76		0,8	F86	
	2.0 -16, Combi Coupé	B202I	93/126	08.1991	08.1992	RFC 42 LS5	A83		1,1	F54-5	
	2.0 C, GL, GLS	B 20	73-74/99-100		08.1990	C 62 LS	A4	B5	0,7	L65	
	2.0 i	B204I	96/131	08.1994	02.1998	RFC 52 LS5	A26	B24	1,1	F54-5	
	2.0 i Cabriolet	B204I	96/131	12.1993	02.1998	RFC 52 LS5	A26	B24	1,1	F54-5	
	2.0 i GLS, GLE, GLi, EMS	B 201...I	81-85/110-115	09.1983	08.1991	C 62 LS	A4	B5	0,7	L65	
	2.0 i Turbo Turbo Coupé	B 204 L Cat	136/185	09.1993		RFC 82 LS5	A65		1,0		
	2.0 i, Coupé	B206I	98/133	07.1993	07.1994	RFC 52 LZDP	A152		0,8		
	2.0 i, Coupé	B204I	96/131	08.1994	02.1998	RFC 52 LS5	A26	B24	1,1	F54-5	
	2.0 S Turbo-16	B202S	104/141	07.1991	12.1993	FC 62 LS (1)	A43		0,8		
	2.0 Turbo-16	B202XL	118/160	11.1985	12.1993	FC 62 LS (1)	A43		0,8		
	2.0 Turbo-16 S	B202XL	129/175	01.1984	12.1988	FC 62 LS (1)	A43		0,8		
	2.0 Turbo-16 S KAT	B202XL	129/175	01.1989	12.1993	FC 62 LS (1)	A43		0,8		
	2.0 Turbo-16 S KAT, Combi Coupé	B202XL	125/170	01.1989	12.1993	FC 62 LS (1)	A43		0,8		
	2.0 Turbo-16 S, Combi Coupé	B202XL	129/175	02.1984	12.1988	FC 62 LS (1)	A43		0,8		
	2.0 Turbo-16, Combi Coupé	B202XL	118/160	11.1985	08.1993	FC 62 LS (1)	A43		0,8		
	2.0 Turbo-16, Combi Coupé	B202L	132/180	01.1993	08.1993	FC 62 LS (1)	A43		0,8		
	2.1 -16	B212I	100/136	08.1990	08.1991	RFC 42 LS5	A83		1,1	F54-5	
	2.3 -16	B234I	110/150	07.1993	02.1998	RFC 52 LS	A3	B16	0,8	F54	
	2.3 i 16V Coupé	B 234...I Cat	110/150	09.1993		RFN 58 LZ (b)	A7	B28	0,8	F54	
	2.3 i 16V Coupé	B 234...I Cat	110/150	09.1993		RFN 58 LZ3A (g)	A515		0,8		
	2.5 -24 V6	B258I	125/170	07.1993	02.1998	RFC 58 L郑4	A193		1,5		
	2.5 -24 V6 Cabriolet	B258I	125/170	12.1993	02.1998	RFC 58 L郑4	A193		1,5		
	2.5 i 24V Coupé	B 258...I Cat	125/170	09.1993		RFC 58 LZ2E	A10	B31	0,9	F54	
	9000	16 : 2.3 i 16V, CD, CS	B 234...I Cat	107-110-114/ 146-150-155	09.1989	12.1998	RFC 58 LS5	A38	B48	1,1	F54-5
		2.0 -16 CD	B204E	110/150	09.1993	12.1998	RFC 82 LS	A76		0,8	F86
		2.0 -16 Turbo	B202XL	129/175	04.1985	12.1991	RFC 82 LS	A76		0,8	F86
		2.0 -16 Turbo	B202XL	118/160	05.1988	08.1993	RFC 82 LS	A76		0,8	F86
2.0 -16 Turbo CD		B202XL	120/163	09.1988	08.1993	RFC 82 LS	A76		0,8	F86	
2.0 -16 Turbo CD		B202L	136/185	09.1989	12.1998	RFC 82 LS	A76		0,8	F86	
2.0 i CD 16		B 202...I Cat	90-92-96/ 122-125-131	12.1985	08.1993	RFC 42 LS5	A83		1,1	F54-5	
2.0 i CS		B 204 I Cat	96/131	09.1993	12.1998	RFC 58 LS5	A38	B48	1,1	F54-5	
2.0 i Turbo CS Turbo		B 204 L Cat	110/150	09.1994	12.1998	RFC 82 LS5	A65		1,1		
2.0 Turbo CD, CD Turbo		B 202...L Cat	118-136/160-185		08.1993	FC 62 LS (1)	A43		1,0		
2.0 Turbo CD, CD Turbo, CS Special		B 202...L Cat	118-136/160-185	05.1988	08.1993	RFC 82 LS5	A65		1,1		
2.0 Turbo Turbo 16		B 202...L Cat	118-120-129/ 160-163-175	09.1984	08.1993	RFC 82 LS5	A65		1,1		
2.3 -16 CD		B234I	107/145	08.1989	08.1993	RFC 52 LS5	A26	B24	1,1	F54-5	
2.3 -16 CD Turbo		B234L	147/200	07.1990	12.1998	RFC 82 LS	A76		0,8	F86	
2.3 -16 CDE		B234I	108/147	09.1993	12.1998	RFC 52 LS5	A26	B24	1,1	F54-5	
2.3 -16 CDE Eco-Power		B234E	125/170	09.1993	12.1998	RFC 82 LS	A76		0,8	F86	
2.3 -16 Turbo		B234L	143/194	09.1990	08.1993	RFC 82 LS	A76		0,8	F86	
2.3 i Turbo CD Turbo, CD Turbo S, CDE Turbo		B 234...L Cat	143-147/194-200	09.1990	12.1998	RFC 82 LS5	A65		1,1		
2.3 i Turbo CS Turbo, CS Aero Turbo, CS Turbo S, CSE Turbo		B 234...L Cat	143-147/194-200	09.1991	08.1993	RFC 82 LS5	A65		1,1		
2.3 i Turbo Turbo 16		B 234...L Cat	143/194	09.1990	08.1993	RFC 82 LS5	A65		1,1		
2.3 Turbo CD Turbo Ecopower, CDE Turbo Eco., CS Turbo Eco.		B 234 E Cat	125/170	09.1993	12.1998	RFC 82 LS5	A65		1,1		
2.3 Turbo CS Aero Turbo		B 234 R Cat	165/224	09.1992	12.1998	RFC 82 LS5	A65		1,1		
3.0 i V6 24V CD, CS, Griffin		B 308 I Cat	155/211	09.1994	12.1998	RFC 58 LZ2E	A10	B31	0,9	F54	
9-3		1.8 t,	B207E	110/150	09.2002		RFN 62 LZDP5	A185		1,0	
		2.0 i	B204I	96/131	02.1998	08.2000	RFC 52 LS5	A26	B24	1,1	F54-5

(1) Available until end of stock

(a) 30 000 km

(b) 60 000 km

(c) Grey sticker on ignition coil

(d) Green sticker on ignition coil

(e) Hex 21 mm

(f) Hex 16 mm

(g) Recommended for cold weather

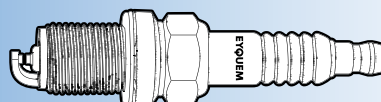

EYQUEM



Box
10
Blister
4



F3

SAAB

	2.0 i 16V	B 204 R	147/200	08.1998		RFC 82 LS5	A65		1,1	
	2.0 i 16V	B 204 E	110/150	01.1999		RC 72 LS	A32	B26	0,7	L87
	2.0 i Cabriolet	B204I	96/131	02.1998	08.2000	RFC 52 LS5	A26	B24	1,1	F54-5
	2.0 SE Turbo	B204R	147/200	02.1998	09.2002	RFC 82 LS	A76		0,8	F86
	2.0 SE Turbo Cabriolet	B204R	147/200	02.1998	08.2003	RFC 82 LS	A76		0,8	F86
	2.0 t	B207L	129/175	09.2002		RFN 62 LZDP5	A185		1,0	
	2.0 T	B207R	154/209	02.2003		RFN 62 LZDP5	A185		1,0	
	2.0 Turbo	B204L	136/185	02.1998	09.2002	RFC 82 LS	A76		0,8	F86
	2.0 Turbo	B204E	113/154	10.1998	09.2002	RFC 82 LS	A76		0,8	F86
	2.0 Turbo	B205E	110/150	01.2001	09.2002	RFN 62 LZDP5	A185		1,0	
	2.0 Turbo Cabriolet	B204L	136/185	02.1998	08.2003	RFC 82 LS	A76		0,8	F86
	2.0 Turbo Cabriolet	B204E	113/154	10.1998	08.2003	RFC 82 LS	A76		0,8	F86
	2.3 i	B234I	110/150	02.1998	09.2002	RFC 52 LZDP	A152		0,8	
	2.3 i 16V Turbo	B 235 E	125/170	06.1997		RFC 82 LS5	A65		1,1	
	2.0 i 16V Turbo	B 205 E	110-140/150-190	06.1997		RFC 82 LS5	A65		1,1	
	2.0 t	B205E	110/150	09.1997	09.2000	RFN 62 LZDP5	A185		1,0	
	2.3 i 16V Turbo	B 235 E	125/170	06.1997		RFC 82 LS5	A65		1,1	
	2.3 t	B235E	125/170	09.1997	08.2000	RFN 62 LZDP5	A185		1,0	
	2.3 t	B235E	136/185	01.2001		RFN 62 LZDP5	A185		1,0	
	2.3 Turbo	B235R	169/230	10.1999	09.2001	RFN 62 LZDP5	A185		1,0	
	2.3 Turbo	B235R	184/250	09.2001		RFN 62 LZDP5	A185		1,0	
	3.0 i V6 24V Turbo	B 308 E	147/200	06.1997		RFC 82 LS5	A65		1,1	
	3.0 V6t	B308E	147/200	01.1998	08.2001	RFN 62 LZDP5	A185		1,0	
9-3 Cabriolet	1.8 t	B207E	110/150	08.2003		RFN 62 LZDP5	A185		1,0	
	2.0 t	B207L	129/175	08.2003		RFN 62 LZDP5	A185		1,0	
	2.0 T	B207R	154/209	08.2003		RFN 62 LZDP5	A185		1,0	
	2.0 Turbo	B205R	151/205	10.1999	08.2003	RFN 62 LZDP5	A185		1,0	
	2.3 i	B234I	110/150	02.1998	08.2000	RFN 62 LZDP5	A185		1,0	
	2.3 Turbo	B235R	165/225	10.1999	09.2001	RFN 62 LZDP5	A185		1,0	
9-5 Kombi	2.0 t	B205E	110/150	10.1998	09.2000	RFN 62 LZDP5	A185		1,0	
	2.0 t		141/192	10.1998	08.2000	RFN 62 LZDP5	A185		1,0	
	2.3 t	B235E	125/170	10.1998	08.2000	RFN 62 LZDP5	A185		1,0	
	2.3 t	B235E	136/185	01.2001		RFN 62 LZDP5	A185		1,0	
	2.3 Turbo	B235R	169/230	10.1999	09.2001	RFN 62 LZDP5	A185		1,0	
	2.3 Turbo	B235R	184/250	09.2001		RFN 62 LZDP5	A185		1,0	
	3.0 V6t	B308E	147/200	10.1998	08.2001	RFN 62 LZDP5	A185		1,0	

SANTANA

2000	3.4		77/105	06.1976	12.1984	C 52 LS	A1	B1	0,8	L65
LAND - ROVER	109 : 2.3 Normal, Super	4GT	51/69	06.1982		C 52 LS	A1	B1	0,6	L65
	109 : 3.4 Cazoria, Normal		77/105	05.1981		C 52 LS	A1	B1	0,6	L65
	1300 : 2.3					C 52 LS	A1	B1	0,6	L65
	88 : 2.3 Ligerero, Normal, Super	4GT	51-59/69-80	05.1980		C 52 LS	A1	B1	0,6	L65
SAMURAI	1.0	F10A	33/45	09.1989		RC 52 LS	A9	B20	0,8	L65
	1.3	G13		09.1986	12.1994	RC 62 LS	A6	B17	0,8	L65
	1.3 i	G13B [OHC]	44/60	10.1991		RC 62 LS	A6	B17	0,8	L65
VITARA	1.6	G16A [OHC] Cat	59/80	09.1989		RC 52 LS	A9	B20	0,8	L65

SATURN

SPORTS COUPE	1.9 i 16V S2,	(7) [DOHC]	90/122	10.1990	08.1995	RFC 42 LS5	A83		1,1	F54-5
	1.9 i 16V SW1	(7) [DOHC]	93/126	08.1994	08.1995	RFC 42 LS5	A83		1,1	F54-5
	1.9 SL, SL1	(9) [OHC]	63/86	10.1990	08.1995	RFC 32 LZ5	A117		1,1	
	1.9 SL1	(8) [OHC]	74/101	08.1994	08.1995	RFC 32 LZ5	A117		1,1	

SEAT

124 D	1200 : 1.2, LS	124 A.000	44/60	04.1974	10.1980	C 62 LS	A4	B5	0,8	L65
	1200 : 1.2, LS	FA12	48/65	01.1968	03.1974	RC 62 LS	A6	B17	0,8	L65
	1200 : 1.2, LS	FA12	48/65	04.1974	08.1975	RC 52 LS	A9	B20	0,8	L65
	1200 : 1.2, LS	FA12	48/65	09.1975	10.1980	RC 72 LS	A32	B26	0,7	L87
	1400 : 1.4		55/75	09.1975	10.1980	C 62 LS	A4	B5	0,8	L65
	1400 : 1.4 Especial		70/95	01.1970	12.1976	RC 72 LS	A32	B26	0,7	L87
	1600 : 1.6 Especial			01.1978	10.1980	C 62 LS	A4	B5	0,8	L65
	1800 : 1.8 Especial			01.1977	05.1979	C 62 LS	A4	B5	0,8	L65
	2000 : 2.0			05.1979	10.1980	C 62 LS	A4	B5	0,8	L65
127	0.9 CL, CL 90	A112 A5.000	33/45	09.1977	09.1981	C 62 LS	A4	B5	0,6	L65

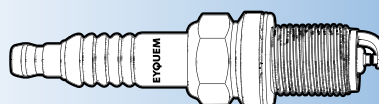

(1) Available until end of stock

- (a) 30 000 km
- (b) 60 000 km
- (c) Grey sticker on ignition coil
- (d) Green sticker on ignition coil

- (e) Hex 21 mm
- (f) Hex 16 mm
- (g) Recommended for cold weather



Box 10
Blister 4



F3-D1

SEAT

	1.0 1010 C, CL		38/42	09.1977	09.1979	C 62 LS	A4	B5	0,6	L65
128	1200 : 1.2		49/67	01.1977	06.1979	C 62 LS	A4	B5	0,6	L65
	1430 : 1.4		57/77	01.1977	06.1979	C 62 LS	A4	B5	0,6	L65
131	1430 : 1.4		55/75	03.1975	12.1982	RC 62 LS	A6	B17	0,7	L65
	1600 : 1.6		69/94	06.1975	12.1983	RC 72 LS	A32	B26	0,7	L87
	1600 : 1.6 L 90		66/90	03.1975	12.1982	RC 62 LS	A6	B17	0,7	L65
	1800 : 1.8		79/107	03.1975	12.1982	RC 62 LS	A6	B17	0,7	L65
	2000 : 1.9 2000 CLX Supermirafiori		83/113	03.1975	12.1982	RC 62 LS	A6	B17	0,7	L65
	2000 : 2.0		117/159	06.1975	12.1983	RC 72 LS	A32	B26	0,7	L87
132	1600 : 1.6, Nuevo E		72/98	03.1973	05.1979	RC 62 LS	A6	B17	0,7	L65
	1800 : 1.8		77/105	03.1973	05.1979	RC 62 LS	A6	B17	0,7	L65
	1900		80/109	05.1979	12.1982	RC 72 LS	A32	B26	0,7	L87
	2.0 Nuevo E 2000			09.1978	10.1980	RC 62 LS	A6	B17	0,7	L65
133	0.8 Especial, L		25-27/34-37	05.1974	11.1979	RC 62 LS	A6	B17	0,8	L65
	1.4					RC 62 LS	A6	B17	0,7	L65
	1.6					RC 62 LS	A6	B17	0,7	L65
	1.8					RC 62 LS	A6	B17	0,7	L65
600 D	0.8		17/23	09.1963	04.1970	C 42 S	A12	B7	0,6	N43
850	0.9		25/34	02.1972	07.1975	C 62 LS	A4	B5	0,6	L65
	0.9		35/47	01.1966	12.1974	C 62 LS	A4	B5	0,6	L65
ALHAMBRA (7V8, 7V9)	1.8 T 20V	AJH	110/150	11.1997	03.2010	RFC 58 LZ3EX	A58	B55	0,9	F54
	1.8 T 20V	AWC	110/150	11.1997	03.2010	FN 58 LZDPR	A198		0,75	
	2.0	ATM/ADY	85/115	04.1996	03.2010	RFC 58 LZ3EX	A58	B55	0,9	F54
	2.0 i	ABF	110/150	08.1996	06.2000	RFC 58 LZ3EX	A58	B55	0,9	F54
	2.0 i LE, SE, SXE	ADY	85/115	04.1996	02.2000	RFC 58 LZ3EX	A58	B55	0,9	F54
	2.8 i	AAA	128/174	03.1996		RFC 42 LZ4E	A154		1,6	
	2.8 i V6 24V, 4 Motion	AYL/AUE	150/204	06.2000	03.2010	RFN 52 LZDPF5	A153		1,0	
ALHAMBRA (710, 711)	1.4 TSI	CAVA/CNWB/CTHA	110/150	06.2010		FN 72 LZIFRS	A551		0,7	
	1.8 TSI	CDA	118/160	11.2012		FN 68 LZDPR	A523		0,7	
	2.0 TSI	CCZA	147/200	11.2010		FN 68 LZDPR	A523		0,7	
ALTEA (5P1)	1.2 TSI	CBZB	77/105	04.2010		FN 68 LZIFRS	A548		0,7	
	1.4 16V	BXW/CGGB	63/86	05.2006		FN 58 LZKFR5	A521		1,05	
	1.4 TSI	CAXC	92/125	11.2007		FC 62 LSDPR	A522		0,9	
	1.6	BGU/BSE/BSF/CCSA/CMXA	75/102	03.2004		RFC 58 LZ3EX	A58	B55	0,9	F54
	1.6 LPG	CHGA	75/102	09.2009	07.2015	RFC 58 LZ3EX	A58	B55	0,9	F54
	1.8 TFSI	BYT/BZB/CDA	118/161	01.2007		FN 68 LZDPR	A523		0,7	
	2.0 FSI	BLR/BLY/BVZ/BVY	110/150	05.2004	03.2009	FN 62 LZFDPR2A	A192		1,1	
	2.0 TFSI	BWA	147/200	04.2006	05.2009	FN 68 LZDPR	A523		0,7	
ALTEA XL (5P5, 5P8)	1.2 TSI	CBZB	77/105	04.2010		FN 68 LZIFRS	A548		0,7	
	1.4 16V	BXW/CGGB	63/86	10.2006		FN 58 LZKFR5	A521		1,05	
	1.4 TSI	CAXC	92/125	11.2007		FC 62 LSDPR	A522		0,9	
	1.6	BSE/BSF/CCSA/CMXA	75/102	10.2006		RFC 58 LZ3EX	A58	B55	0,9	F54
	1.6 LPG	CHGA	75/102	09.2009	07.2015	RFC 58 LZ3EX	A58	B55	0,9	F54
	1.8 TFSI	BYT/BZB/CDA	118/161	01.2007		FN 68 LZDPR	A523		0,7	
	2.0 FSI	BVY/BVZ	110/150	10.2006	03.2009	FN 62 LZFDPR2A	A192		1,1	
	2.0 TFSI, 4x4	BWA	147/200	10.2006	05.2009	FN 68 LZDPR	A523		0,7	
	2.0 TFSI	CCZB	155/211	05.2009		FN 68 LZDPR	A523		0,7	
AROSA (6H)	1.0	AHT	37/50	05.1997	01.2001	FN 58 LZDPR	A198		0,75	
	1.0	AER-ALL	37/50	05.1997	06.2004	RC 58 LZ3EX	A34	B54	0,9	L65
	1.0	ALD-ANV-AUC	37/50	05.1997	06.2004	RFN 52 LZDPF5	A153		1,0	
	1.4	AEX-APQ-AKV-AUD	44/60	02.1997	06.2004	RC 58 LZ3EX	A34	B54	0,9	L65
	1.4	AKK-ANW	44/60	05.1997	06.2004	RFN 52 LZDPF5	A153		1,0	
	1.4 16V	AHW	55/75	01.1998		RFC 58 LZ3EX	A58	B55	0,9	F54
	1.4 16V	AFK/ANM/AQ/AUB	74/101	01.2000	06.2004	RFC 58 LZ3EX	A58	B55	0,9	F54
CORDOBA (6K1, 6K2)	1.0	AER	37/50	09.1996	06.1999	RC 58 LZ3EX	A34	B54	0,9	L65
	1.4 i	ABD	44/60	05.1993	12.1995	C 52 LS3X	A28	B25	0,9	L65
	1.4 i	AEX-APQ-AKV	44/60	06.1994	06.1999	RC 58 LZ3EX	A34	B54	0,9	L65
	1.4 i 16V	AFH	74/101	07.1996	06.1999	RFC 58 LZ3EX	A58	B55	0,9	F54
	1.6 i	1F	55/75	11.1993	06.1999	RC 52 LZ3EX	A35		0,9	L65
	1.6 i	ABU	55/75	05.1993	07.1994	C 52 LS3X	A28	B25	0,9	L65
	1.6 i	AEE-ALM	55/75	03.1997	06.1999	RC 58 LZ3EX	A34	B54	0,9	L65
	1.6 i	AFT-AKL	74/101	06.1996	10.1999	RFC 58 LZ3EX	A58	B55	0,9	F54
	1.8 i	ABS-ADZ-ACC	66/90	02.1993	06.1999	RC 58 LZ3EX	A34	B54	0,9	L65

(1) Available until end of stock

(a) 30 000 km

(b) 60 000 km

(c) Grey sticker on ignition coil

(d) Green sticker on ignition coil

(e) Hex 21 mm

(f) Hex 16 mm

(g) Recommended for cold weather



EYQUEM



Box
10

Blister
4



F3→1

SEAT										
	1.8 i 16V	ADL	95/129	09.1993	08.1996	RFC 62 LZ3EX	A86		0,9	F86
	2.0 i	2E-AGG	85/115	09.1993	06.1999	RC 58 LZ3EX	A34	B54	0,9	L65
	2.0 i 16V	ABF	110/150	01.1995	06.1999	RFC 62 LZ3EX	A86		0,9	F86
CORDOBA Vario (6K5)	1.4	ANW-AKK-AUD	44/60	06.1999	10.2002	RFN 52 LZDPF5	A153		1,0	
	1.4 i	AEX-APQ-AKV	44/60	09.1996	06.1999	RC 58 LZ3EX	A34	B54	0,9	L65
	1.4 16V	APE/AUA	55/75	06.1999	10.2002	RFC 58 LZ3EX	A58	B55	0,9	F54
	1.6 i	ALM-ABU	55/75	06.1999	10.2002	RC 58 LZ3EX	A34	B54	0,9	L65
	1.6 i	1F	55/75	05.1997	06.1999	RC 52 LZ3EX	A35		0,9	L65
	1.6 i	AEE-ALM	55/75	09.1996	06.1999	RC 58 LZ3EX	A34	B54	0,9	L65
	1.6 i	AFT	74/101	09.1996	10.1999	RFC 58 LZ3EX	A58	B55	0,9	F54
CORDOBA (6K2)	1.6 i	AEH-AKL-APF-AUR	74/101	06.1999	10.2002	RFC 58 LZ3EX	A58	B55	0,9	F54
	1.0	ALD/ANV/AUC	37/50	06.1999	10.2002	RFN 52 LZDPF5	A153		1,0	
	1.4	ANW-AKK-AUD	44/60	06.1999	10.2002	RFN 52 LZDPF5	A153		1,0	
	1.4 16V	APE/AUA	55/75	05.2000	10.2002	RFC 58 LZ3EX	A58	B55	0,9	F54
	1.4 16V	AQ-AUB	74/101	02.2000	10.2002	RFC 58 LZ3EX	A58	B55	0,9	F54
	1.6	ALM	55/75	06.1999	10.2002	RC 58 LZ3EX	A34	B54	0,9	L65
	1.6	AEH-AKL-APF-AUR	74/101	06.1999	10.2002	RFC 58 LZ3EX	A58	B55	0,9	F54
CORDOBA (6L2)	1.8 T 20V Cupra	AQX-AYP	115/156	07.2000	10.2002	RFC 58 LZ3EX	A58	B55	0,9	F54
	1.2	AZQ-BME	47/64	10.2002	06.2006	FN 58 LZKFR	A183		0,9	
	1.2 12V	BXV	51/69	05.2006	11.2009	FN 58 LZKFR	A183		0,9	
	1.4 16V	BBY-BKY (Boite vitesse mécanique)	55/75	09.2002	12.2007	RFC 58 LZ3EX	A58	B55	0,9	F54
	1.4 16V	BBY-BKY (Boite vitesse Automatique)	55/75	09.2002	12.2007	RFN 52 LZDPF5	A153		1,0	
	1.4 16V	BXW	63/86	05.2006	11.2009	FN 58 LZKFR5	A521		1,05	
	1.4 16V	AUB/BBZ	74/101	10.2002	11.2009	RFC 58 LZ3EX	A58	B55	0,9	F54
	1.6 16V	BTS	77/105	11.2006	11.2009	FN 58 LZKFR5	A521		1,05	
EXEO (3R2)	2.0	AZL/BBX	85/115	09.2002	11.2009	RFC 58 LZ3EX	A58	B55	0,9	F54
	1.6	ALZ	75/102	03.2009	09.2010	RFC 58 LZ3EX	A58	B55	0,9	F54
	1.8 T	CFMA	110/150	12.2008	05.2010	RFC 58 LZ3EX	A58	B55	0,9	F54
	1.8 TSI	CDHA	88/120	09.2010	08.2013	FN 68 LZDPR	A523		0,7	
	1.8 TSI	CDHB	118/161	05.2010	08.2013	FN 68 LZDPR	A523		0,7	
	2.0 TFSI	BWE	147/200	03.2009	08.2013	FN 68 LZDPR	A523		0,7	
	2.0 TFSI	CDND	155/211	05.2010	08.2013	FN 68 LZDPR	A523		0,7	
EXEO ST (3R5)	1.6	ALZ	75/102	03.2009	09.2010	RFC 58 LZ3EX	A58	B55	0,9	F54
	1.8 T	CFMA	110/150	06.2009	05.2010	FN 58 LZDPR	A198		0,75	
	1.8 TSI	CDHA	88/120	09.2010		FN 68 LZDPR	A523		0,7	
	1.8 TSI	CDHB	118/161	05.2010		FN 68 LZDPR	A523		0,7	
	2.0 TFSI	BWE	147/200	03.2009		FN 68 LZDPR	A523		0,7	
	2.0 TFSI	CDND	155/211	05.2010		FN 68 LZDPR	A523		0,7	
FURA	0.9 GL, L		29-32/39-44	09.1981	12.1984	RC 62 LS	A6	B17	0,8	L65
	1.4 Crono	124.B3.000	55/75	09.1981	12.1984	RC 62 LS	A6	B17	0,8	L65
IBIZA I (021A)	0.9	1000 GL 7000	29-32/39-44	06.1984	09.1993	RC 62 LS	A6	B17	0,8	L65
	0.9	146. A 000-09 NCA	29/40	08.1990	05.1993	RC 62 LS	A6	B17	0,8	L65
	0.9	146.A.000	32/44	06.1984	05.1993	RC 62 LS	A6	B17	0,8	L65
	1.2	021.A1.000	44-47/60-64	06.1984	05.1993	RFC 62 LS	A48		0,8	F86
	1.2	021.A1.000	46/63	06.1984	05.1993	RFC 62 LS	A48		0,8	F86
	1.2 i	021.C1.000	52/71	08.1989	05.1993	RFC 82 LS	A76		0,8	F86
	1.5	021.A2.000	63/85	06.1984	09.1993	RFC 82 LS	A76		0,8	F86
	1.5 i	021.B2-C2-D2.000 Cat	65/89	06.1984	09.1993	RFC 82 LS	A76		0,8	F86
	1.5 i CAT	021.C.2000	66/90	10.1986	05.1993	RFC 82 LS	A76		0,8	F86
	1.5 i	021.B.2000	74/100	10.1986	05.1993	RFC 82 LS	A76		0,8	F86
	1.5 Turbo		79/107	07.1988	05.1993	RFC 82 LS	A76		0,8	F86
	1.7 i	021.A3-B3-C3.000 Cat	72/98	01.1991	09.1993	RFC 82 LS	A76		0,8	F86
	021.B3.000	76/103	01.1991	05.1993	RFC 82 LS	A76		0,8	F86	
IBIZA II (6K1)	1.0 i	AER	37/50	09.1996	08.1999	RC 58 LZ3EX	A34	B54	0,9	L65
	1.0 i	AAU	33/45	03.1993	09.1996	C 52 LS3X	A28	B25	0,9	L65
	1.3 i	2G	40/54	03.1993	08.1994	C 62 LS3X	A13	B15	0,8	L65
	1.3 i	AAV	40/54	03.1993	08.1999	C 52 LS3X	A28	B25	0,9	L65
	1.4 i	ABD	44/60	05.1993	12.1995	C 52 LS3X	A28	B25	0,9	L65
	1.4 i	AKV-AEX-APQ	44/60	01.1995	08.1999	RC 58 LZ3EX	A34	B54	0,9	L65
	1.4 i	ANX	44/60	01.1998		RC 58 LZ3EX	A34	B54	0,9	L65
	1.4 i 16V	AFH	74/101	09.1997	08.1999	RFC 58 LZ3EX	A58	B55	0,9	F54
	1.6 i	1F	55/75	11.1993	06.1999	RC 52 LZ3EX	A35		0,9	L65
	1.6 i	AEK-AFT	74/101	04.1996	08.1999	RFC 58 LZ3EX	A58	B55	0,9	F54

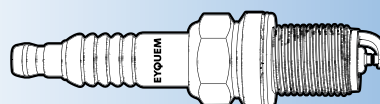

(1) Available until end of stock
 (a) 30 000 km
 (b) 60 000 km
 (c) Grey sticker on ignition coil
 (d) Green sticker on ignition coil

(e) Hex 21 mm
 (f) Hex 16 mm
 (g) Recommended for cold weather



kW/HP



Box
10

Blister
4



F3-D1

SEAT

	1.6 i	ABU	55/75	03.1993	07.1994	C 52 LS3X	A28	B25	0,9	L65	
	1.6 i	AEE-ALM	55/75	03.1997	08.1999	RC 58 LZ3EX	A34	B54	0,9	L65	
	1.8 i	ABS-ACC-ADZ	66/90	03.1993	08.1999	RC 58 LZ3EX	A34	B54	0,9	L65	
	1.8 i 16V	ADL	95/129	05.1993	08.1996	RFC 62 LZ3EX	A86		0,9	F86	
	2.0 i GTi	2E-AGG	85/115	03.1993	08.1999	RC 58 LZ3EX	A34	B54	0,9	L65	
	2.0 i 16V	ABF	110/150	06.1996	08.1999	RFC 62 LZ3EX	A86		0,9	F86	
IBIZA III (6L1)	1.0	ALD-ANV-AUC	37/50	08.1999	02.2002	RFN 52 LZDPF5	A153		1,0		
	1.0 16V	AVZ-AST	51/69	10.1999	02.2002	RFC 52 LS3	A66		1,2		
	1.4	AKK-ANW-AUD	44/60	08.1999	02.2002	RFN 52 LZDPF5	A153		1,0		
	1.4 16V	APE-AUA	55/75	05.2000	02.2002	RFC 58 LZ3EX	A58	B55	0,9	F54	
	1.4 16V	AQQ/AUB	74/101	08.1999	02.2002	RFC 58 LZ3EX	A58	B55	0,9	F54	
	1.6	ALM	55/75	08.1999	02.2002	RC 58 LZ3EX	A34	B54	0,9	L65	
	1.6	AEH-AKL-APF-AUR	74/101	08.1999	02.2002	RFC 58 LZ3EX	A58	B55	0,9	F54	
	1.8 T 20V Cupra	AQX/AYP	115/156	07.2000	02.2002	RFC 58 LZ3EX	A58	B55	0,9	F54	
IBIZA IV (6J5, 6P1)	1.2	BBM	44/60	06.2007	05.2008	FN 58 LZKFR	A183		0,9		
	1.2	AZQ/BME	47/64	02.2002	06.2006	FN 58 LZKFR	A183		0,9		
	1.2 12V	BXV	51/69	05.2006	11.2009	FN 58 LZKFR	A183		0,9		
	1.4 16V	BKY/BBY (Boite Vitesse Mécanique)	55/75	02.2002	12.2007	RFC 58 LZ3EX	A58	B55	0,9	F54	
	1.4 16V	BKY/BBY (Boite Vitesse Automatique)	55/75	02.2002	12.2007	RFN 52 LZDPF5	A153		1,0		
	1.4 16V	BXW	63/86	05.2006	11.2009	FN 58 LZKFR5	A521		1,05		
	1.4 16V	AUB/BBZ	74/101	02.2002	11.2009	RFC 58 LZ3EX	A58	B55	0,9	F54	
	1.6 16V	BTS	77/105	11.2006	11.2009	FN 58 LZKFR5	A521		1,05		
	1.8 T FR	BKV/BJX	110/150	12.2003	05.2008	FN 58 LZDPR	A198		0,75		
	1.8 T Cupra R	BBU/BLZ	132/180	01.2004	02.2008	FN 58 LZDPR	A198		0,75		
	2.0	AZL/BBX	85/115	04.2002	11.2009	RFC 58 LZ3EX	A58	B55	0,9	F54	
	NEW	1.0 TSI	CHZB	70/95	05.2015		ZN 62 LSDPFRSO	A538		0,75	
	NEW	1.0 TSI	CHZC	81/110	05.2015		ZN 62 LSDPFRSO	A538		0,75	
NEW	1.2 TSI	CBZA	63/86	08.2012		FN 68 LZIPFRS	A548		0,7		
NEW	1.2 TSI	CJZC	66/90	05.2015		ZN 62 LSDPFRSO	A538		0,75		
NEW	1.2 TSI	CBZB	77/105	09.2010		FN 68 LZIPFRS	A548		0,7		
NEW	1.2 TSI	CJZD	81/110	09.2015		ZN 62 LSDPFRSO	A538		0,75		
	1.2	CGPB	44/60	07.2009		FN 58 LZKFR5	A521		1,05		
	1.2	BZG/CGPA	51/69	03.2008		FN 58 LZKFR5	A521		1,05		
	1.2	CJLB	51/69	03.2008		FN 58 LZKFR	A183		0,9		
	1.4	BXW/CGGB	63/86	03.2008		FN 58 LZKFR5	A521		1,05		
NEW	1.4 TSI	CPTA	103/140	10.2013		ZN 62 LSDPFRSO	A538		0,75		
NEW	1.4 TSI	CAVF/CNUB	110/150	06.2009		FN 72 LZIPFRS	A551		0,7		
	1.6	BTS	77/105	05.2008		FN 58 LZKFR5	A521		1,05		
	1.6 LPG	CNKA	60/82	05.2011		FN 58 LZKFR5	A521		1,05		
IBIZA IV SPORTCOUPE (6J1, 6P5)	NEW	1.0 TSI	CHZB	70/95	05.2015		ZN 62 LSDPFRSO	A538		0,75	
	NEW	1.0 TSI	CHZC	81/110	05.2015		ZN 62 LSDPFRSO	A538		0,75	
	NEW	1.2 TSI	CBZA	63/86	08.2012		FN 68 LZIPFRS	A548		0,7	
	NEW	1.2 TSI	CJZC	66/90	05.2015		ZN 62 LSDPFRSO	A538		0,75	
	NEW	1.2 TSI	CBZB	77/105	09.2010		FN 68 LZIPFRS	A548		0,7	
	NEW	1.2 TSI	CJZD	81/110	09.2015		ZN 62 LSDPFRSO	A538		0,75	
		1.2	CGPB	44/60	07.2009		FN 58 LZKFR5	A521		1,05	
		1.2	BZG/CGPA	51/69	07.2008		FN 58 LZKFR5	A521		1,05	
		1.4	BXW/CGGB	63/86	07.2008		FN 58 LZKFR5	A521		1,05	
	NEW	1.4 TSI	CPTA	103/140	10.2013		ZN 62 LSDPFRSO	A538		0,75	
	NEW	1.4 TSI	CAVF/CNUB	110/150	06.2009		FN 72 LZIPFRS	A551		0,7	
	NEW	1.4 TSI Cupra	CAVE/CTHE	132/180	06.2009		FN 72 LZIPFRS	A551		0,7	
		1.6	BTS	77/105	07.2008		FN 58 LZKFR5	A521		1,05	
	1.6 LPG	CNKA	60/82	05.2011		FN 58 LZKFR5	A521		1,05		
IBIZA IV ST (6J8, 6P8)	NEW	1.0 TSI	CHZB	70/95	05.2015		ZN 62 LSDPFRSO	A538		0,75	
	NEW	1.0 TSI	CHZC	81/110	05.2015		ZN 62 LSDPFRSO	A538		0,75	
	NEW	1.2 TSI	CBZA	63/86	09.2012		FN 68 LZIPFRS	A548		0,7	
	NEW	1.2 TSI	CJZC	66/90	05.2015		ZN 62 LSDPFRSO	A538		0,75	
	NEW	1.2 TSI	CBZB	77/105	09.2010		FN 68 LZIPFRS	A548		0,7	
	NEW	1.2 TSI	CJZD	81/110	09.2015		ZN 62 LSDPFRSO	A538		0,75	
		1.2	CGPB	44/60	05.2010		FN 58 LZKFR5	A521		1,05	

(1) Available until end of stock

(a) 30 000 km

(b) 60 000 km

(c) Grey sticker on ignition coil

(d) Green sticker on ignition coil

(e) Hex 21 mm

(f) Hex 16 mm

(g) Recommended for cold weather

(g) Recommended for cold weather

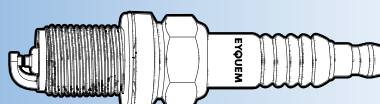

EYQUEM



Box
10

Blister
4



F3

SEAT

	1.2	CGPA	51/69	05.2010		FN 58 LZKFR5	A521		1,05	
	1.4	CGGB	63/86	03.2010		FN 58 LZKFR5	A521		1,05	
	NEW 1.4 TSI	CPTA	103/140	10.2013		ZN 62 LSDPFRSO	A538		0,75	
	NEW 1.4 TSI	CAVF/CNUB	110/150	02.2012		FN 72 LZIPFRS	A551		0,7	
	NEW 1.4 TSI	CZEA	110/150	11.2015		ZN 62 LSDPFRSO	A538		0,75	
INCA (6K9)	1.4 i	AEX-AKV-AQP	44/60	11.1995	06.2003	RC 58 LZ3EX	A34	B54	0,9	L65
	1.4 i	AUD	44/60	11.1995	06.2003	RFN 52 LZDPF5	A153		1,1	
	1.4 16V	AUA	55/75	04.2000	06.2003	RFC 58 LZ3EX	A58	B55	0,9	F54
	1.6 i	1F	55/75	11.1995	05.1998	RC 52 LZ3EX	A35		0,9	L65
	1.6 i	AEE	55/75	06.1997	09.2000	RC 52 LZ3EX	A35		0,9	L65
LEON (1M1)	1.4 16V	AHW-AXP-APE-BCA	55/75	12.1999	04.2004	RFC 58 LZ3EX	A58	B55	0,9	F54
	1.6	AEH/AKL	74/101	11.1999	06.2006	RFC 58 LZ3EX	A58	B55	0,9	F54
	1.6	BFQ	75/102	10.2005	06.2006	RFC 58 LZ3EX	A58	B55	0,9	F54
	1.6 16V	AUS	77/105	09.2000	01.2002	RFC 58 LZ3EX	A58	B55	0,9	F54
	1.6 16V	AZD-BCB	77/105	09.2000	06.2006	RFN 52 LZDPF5	A153		1,1	
	1.8 20V	AGN/APG	92/125	11.1999	06.2006	RFC 58 LZ3EX	A58	B55	0,9	F54
	1.8 20V T	APP/AUQ	132/180	11.1999	06.2006	FN 58 LZDPR	A198		0,75	
	1.8 20V T4	ARY/AJQ	132/180	11.1999	06.2006	FN 58 LZDPR	A198		0,75	
	1.8 T Cupra R	AMK	154/209	02.2002	06.2006	FN 58 LZDPR	A198		0,75	
	1.8 T Cupra R	BAM	165/225	07.2003	06.2006	FN 58 LZDPR	A198		0,75	
	2.8	BDE	150/204	05.2002	06.2004	RFN 52 LZDPF5	A153		1,1	
	2.8 Cupra 4	AUE	150/204	02.2001	06.2006	RFN 52 LZDPF5	A153		1,1	
LEON II (1P1)	NEW 1.2 TSI	CBZB	77/105	02.2010	12.1012	FN 68 LZIPFRS	A548		0,7	
	1.4 16V	BXW/CGGB	63/86	06.2006	12.2012	FN 58 LZKFR5	A521		1,05	
	1.4 TSI	CAXC	92/125	11.2007	12.2012	FC 62 LSDPR	A522		0,9	
	1.6	BSE/BSF/CCSA	75/102	07.2005	12.2012	RFC 58 LZ3EX	A58	B55	0,9	F54
	1.6 LPG	CHGA	75/102	12.2009	12.2012	RFC 58 LZ3EX	A58	B55	0,9	F54
	1.8 TSI	BZB/CDA	118/161	06.2007	12.2012	FN 68 LZDPR	A523		0,7	
	2.0 FSI	BLR/BLY/BVZ/BVY	110/150	07.2005	05.2010	FN 62 LZFDPR2A	A192		1,1	
	2.0 TFSI	BWA1	136/185	09.2005	05.2006	FN 68 LZDPR	A523		0,7	
	2.0 TFSI	BWA	147/200	05.2005	03.2009	FN 68 LZDPR	A523		0,7	
	2.0 TFSI	CCZB	155/211	06.2009	12.2012	FN 68 LZDPR	A523		0,7	
	2.0 TFSI	BWJ	177/240	11.2006	05.2011	FN 68 LZDPR	A523		0,7	
	2.0 Cupra R	CDLA	195/265	09.2009	12.2012	FN 68 LZDPR	A523		0,7	
LEON (5F1)	NEW 1.2 TSI	CJZB/CYVA	63/86		12.2012	ZN 62 LSDPFRSO	A538		0,75	
	NEW 1.2 TSI	CJZA	77/105	01.2013		ZN 62 LSDPFRSO	A538		0,75	
	NEW 1.2 TSI	CYVB	81/110	04.2014		ZN 62 LSDPFRSO	A538		0,75	
	NEW 1.4 TGI	CPWA	81/110	02.2013		ZN 62 LSDPFRSO	A538		0,75	
	NEW 1.4 TSI	CMBA/CXSA	90/122	11.2012		ZN 62 LSDPFRSO	A538		0,75	
	NEW 1.4 TSI	CZCA	92/125	05.2014		ZN 62 LSDPFRSO	A538		0,75	
	NEW 1.4 TSI	CHPA/CPTA	103/140	09.2012		ZN 62 LSDPFRSO	A538		0,75	
	NEW 1.4 TSI	CZEA	110/150	05.2014		ZN 62 LSDPFRSO	A538		0,75	
	NEW 1.8 TSI	CJSA	132/180	02.2013		FN 72 HZIPRSO	A537		0,75	
	NEW 2.0 Cupra	CJXE	195/265	10.2013		FN 72 HZIPRSO	A537		0,75	
	NEW 2.0 Cupra	CJXA	206/280	10.2013		FN 72 HZIPRSO	A537		0,75	
	NEW 2.0 Cupra	CJXH	213/290	10.2015		FN 72 HZIPRSO	A537		0,75	
LEON SC (5F5)	NEW 1.2 TSI	CJZB/CYVA	63/86	01.2013		ZN 62 LSDPFRSO	A538		0,75	
	NEW 1.2 TSI	CJZA	77/105	02.2013		ZN 62 LSDPFRSO	A538		0,75	
	NEW 1.2 TSI	CYVB	81/110	05.2014		ZN 62 LSDPFRSO	A538		0,75	
	NEW 1.4 TSI	CMBA/CXSA	90/122	02.2013		ZN 62 LSDPFRSO	A538		0,75	
	NEW 1.4 TSI	CZCA	92/125	05.2014		ZN 62 LSDPFRSO	A538		0,75	
	NEW 1.4 TSI	CHPA/CPTA	103/140	02.2013		ZN 62 LSDPFRSO	A538		0,75	
	NEW 1.4 TSI	CZEA	110/150	05.2014		ZN 62 LSDPFRSO	A538		0,75	
	NEW 1.8 TSI	CJSA	132/180	02.2013		FN 72 HZIPRSO	A537		0,75	
	NEW 2.0 Cupra	CJXE	195/265	10.2013		FN 72 HZIPRSO	A537		0,75	
	NEW 2.0 Cupra	CJXA	206/280	10.2013		FN 72 HZIPRSO	A537		0,75	
	NEW 2.0 Cupra	CJXH	213/290	10.2015		FN 72 HZIPRSO	A537		0,75	
LEON ST (5F8)	NEW 1.2 TSI	CJZB/CYVA	63/86	11.2013		ZN 62 LSDPFRSO	A538		0,75	
	NEW 1.2 TSI	CJZA	77/105	01.2013		ZN 62 LSDPFRSO	A538		0,75	
	NEW 1.2 TSI	CYVB	81/110	05.2014		ZN 62 LSDPFRSO	A538		0,75	
	NEW 1.4 TGI	CPWA	81/110	10.2013		ZN 62 LSDPFRSO	A538		0,75	
	NEW 1.4 TSI	CMBA/CXSA	90/122	10.2013		ZN 62 LSDPFRSO	A538		0,75	
	NEW 1.4 TSI	CZCA	92/125	05.2014		ZN 62 LSDPFRSO	A538		0,75	
	NEW 1.4 TSI	CHPA/CPTA	103/140	10.2013		ZN 62 LSDPFRSO	A538		0,75	
	NEW 1.4 TSI	CZEA	110/150	05.2014		ZN 62 LSDPFRSO	A538		0,75	



(1) Available until end of stock

- (a) 30 000 km
- (b) 60 000 km
- (c) Grey sticker on ignition coil
- (d) Green sticker on ignition coil

- (e) Hex 21 mm
- (f) Hex 16 mm
- (g) Recommended for cold weather



Box
10

Blister
4



F3-1

SEAT

	NEW	1.8 TSI	CJSA	132/180	10.2013		FN 72 HZIPRSO	A537		0,75	
	NEW	1.8 TSI 4Drive	CJSA (DF4)	132/180	11.2014		FN 72 HZIPRSO	A537		0,75	
	NEW	2.0 Cupra	CJXE	195/265	10.2013		FN 72 HZIPRSO	A537		0,75	
	NEW	2.0 Cupra	CJXA	206/280	10.2013		FN 72 HZIPRSO	A537		0,75	
	NEW	2.0 Cupra	CJXH	213/290	10.2015		FN 72 HZIPRSO	A537		0,75	
MALAGA (023A)		1.2 i	021 A 1000	44-47-51/60-64-70	06.1984	12.1993	RFC 82 LS	A76		0,8	F86
		1.2 i	021 C 1000	52/71	12.1989	12.1993	RFC 82 LS	A76		0,8	F86
		1.5 i	021 A 2000/C 2000/D 2000	63-66-70/85-90-95	05.1985	12.1993	RFC 82 LS	A76		0,8	F86
		1.5 i	021 B 2000	74/100	01.1987	12.1993	RFC 82 LS	A76		0,8	F86
		1.7 i		77/105	01.1991	12.1993	RFC 82 LS	A76		0,8	F86
MARBELLA (28)		0.8	08 NCA	25/34	01.1987	12.1993	RC 62 LS	A6	B17	0,8	L65
		0.9	09 NCA	29/39	01.1987	12.1992	RC 62 LS	A6	B17	0,8	L65
		0.9	09 NCB Cat	30/41	09.1991	12.1993	RC 52 LS	A9	B20	0,8	L65
		0.9	08 NCB	32/44	07.1997	10.1998	RC 32 LS	A49	B19	0,75	L3
		0.9 KAT	09 NCB	29/39	01.1990	11.1996	RC 32 LS	A49	B19	0,75	L3
		0.9 KAT	08 NCB	30/41	11.1996	10.1998	RC 32 LS	A49	B19	0,75	L3
		0.9 Special	1170A Cat	30/41	10.1996		RC 62 LS	A6	B17	0,8	L65
Mii (KF1)	NEW	1.0 EcoFuel	CPGA	50/68	11.2012		ZN 62 LSDPFRSO	A538		0,75	
PANDA (141A)		0.9	100 GL 3000	31/42	10.1980	12.1986	C 62 LS	A4	B5	0,6	L65
RITMO (138)		1.4		57/77	07.1978	09.1983	C 62 LS	A4	B5	0,6	L65
RONDA (022A)		1.2	Sigma 1.2 - 021.A1.000	44-47/60-64	05.1984	08.1991	RFC 82 LS	A76		0,7	F86
		1.5	021.A2.000 - Sigma 1.5	63/86	05.1984	01.1991	RFC 82 LS	A76		0,7	F86
		1.6 100 CLX, Crono	138 AR 6000	74/101		12.1986	RC 72 LS	A32	B26	0,7	L87
		2.0				11.1984	RC 62 LS	A6	B17	0,7	L65
		65 : 1.2 CL	124 B 6000	47/64		12.1983	RC 62 LS	A6	B17	0,7	L65
		75 : 1.4 CLX	124 B 7000			12.1983	RC 62 LS	A6	B17	0,7	L65
SPORT		1.2		49/67			RC 62 LS	A6	B17	0,8	L65
		1.4		57/78			RC 62 LS	A6	B17	0,8	L65
TERRA		0.9	09 NCA	29/39		08.1991	RC 62 LS	A6	B17	0,8	L65
		0.9	903 EAC		01.1992		RC 32 LS	A49	B19	0,8	L3
TOLEDO I (1L)		1.6 i	1F	52/71	05.1991	09.1991	C 52 LS3X	A28	B25	0,9	L65
		1.6 i	1F	52/71	10.1991	05.1993	RC 52 LZ3EX	A35		0,9	L65
		1.6 i	1F-EZ-ABN	54-55/73-75	05.1991	03.1999	RC 52 LZ3EX	A35		0,9	L65
		1.6 i	1F	55/75	01.1993	03.1999	RC 52 LZ3EX	A35		0,9	L65
		1.6 i	AFT	74/101	11.1996	03.1999	RFC 58 LZ3EX	A58	B55	0,9	F54
		1.6 i	AEK- AFT-AKS	74/101	01.1996	10.1998	RFC 58 LZ3EX	A58	B55	0,9	F54
		1.8 i	ACC	66/90	01.1995		RC 58 LZ3EX	A34	B54	0,9	L65
		1.8 i	RP	66/90	05.1991	11.1993	C 62 LS3X	A13	B15	0,8	L65
		1.8 i	RP	66/90	12.1993	12.1996	RC 58 LZ3EX	A34	B54	0,9	L65
		1.8 i	ABS-ADZ	66/90	01.1993	04.1997	RC 58 LZ3EX	A34	B54	0,9	L65
		1.8 i 16V	ADL	95/129	08.1991	08.1993	FC 62 LS3X	A57		0,9	F86
		1.8 i 16V	PL	95/129	05.1991	03.1994	RFC 62 LZ3EX	A86		0,9	F86
		1.8 i 16V	KR	102/139	05.1991	12.1992	RFC 62 LS3X	A59		0,9	F86
		2.0 i	2E-AGG	85/115	05.1991	03.1999	RC 58 LZ3EX	A34	B54	0,9	L65
		2.0 i 16V	9A	100/136			RFC 62 LZ3EX	A86		0,9	F86
		2.0 i 16V	ABF	110/150	11.1993	03.1999	RFC 62 LZ3EX	A86		0,9	F86
TOLEDO II (1M2)		1.4 i 16V	APE-AHW-AXP-BCA	55/75	11.1999	05.2002	RFC 58 LZ3EX	A58	B55	0,9	F54
		1.6	ABU	55/75	03.1993		RC 58 LZ3EX	A34	B54	0,9	L65
		1.6	ABM	52/71	11.1993		RC 52 LZ3EX	A35		0,9	L65
		1.6	AEH/AKL/APF	74/101	10.1998	07.2004	RFC 58 LZ3EX	A58	B55	0,9	F54
		1.6 i	ATN	77/105	11.1999		RFC 58 LZ3EX	A58	B55	0,9	F54
		1.6 16V	AUS-AZD	77/105	09.2000	12.2001	RFC 58 LZ3EX	A58	B55	0,9	F54
		1.6 16V	AZD-BCB	77/105	01.2002	07.2004	RFN 52 LZDPF5	A153		1,1	
		1.8 20V	AGN/APG	92/125	10.1998	07.2004	RFC 58 LZ3EX	A58	B55	0,9	F54
		1.8 AWD	ARY	132/180	05.2001	04.2004	FN 58 LZDPR	A198		0,75	
		1.8 AWD	BAM	165/224	05.2003	10.2005	FN 58 LZDPR	A198		0,75	
		1.8 20VT	APP-AUQ	132/180	05.2001	05.2006	FN 58 LZDPR	A198		0,75	
		2.3 i V5	AGZ	110/150	10.1998	11.2000	RFC 42 LZ4E	A154		1,6	
		2.3 i V5 LPG	AGZ	110/150	10.1998	11.2000	RFC 52 LZ4E	A159		1,6	
		2.3 V5 20V	AQN	125/170	05.2001	11.2003	RFN 52 LZDPF5	A153		1,1	
TOLEDO III (5P2)		1.4 16V	BXW	63/86	05.2006	05.2009	FN 58 LZKFR	A183		0,9	
		1.6	BGU-BSE-BSF	75/102	10.2004	05.2009	RFC 58 LZ2E	A10	B31	0,9	F54
		1.8 TFSI	BYT/BZB/CDAA	118/161	01.2007	05.2009	FN 68 LZDPR	A523		0,7	
		2.0 FSI	BLR/BVY	110/150	10.2004	05.2009	FN 62 LZFDPR2A	A192		1,1	
		2.0 FSI	BLY/BVZ	110/150	10.2004	05.2009	RFN 58 LZDP5	A187		1,1	

(1) Available until end of stock

(a) 30 000 km

(b) 60 000 km

(c) Grey sticker on ignition coil

(d) Green sticker on ignition coil

(e) Hex 21 mm

(f) Hex 16 mm

(g) Recommended for

cold weather

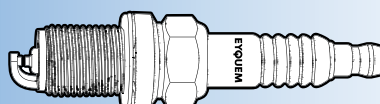

EYQUEM



Box
10

Blister
4



F3-D1

SEAT										
	2.0 TFSI	BWA	147/200	11.2005	05.2009	FN 68 LZDPR	A523		0,7	
TOLEDO IV (KG3)	1.2	CGPC	55/75	07.2012		FN 58 LZKFR5	A521		1,05	
	NEW 1.2 TSI	CBZA	63/86	07.2012		FN 68 LZPFRS	A548		0,7	
	NEW 1.2 TSI	CJZC	66/90	05.2015		ZN 62 LSDPFRSO	A538		0,75	
	NEW 1.2 TSI	CJZD	81/110	05.2015		ZN 62 LSDPFRSO	A538		0,75	
	1.4 TSI	CAXA	90/122	07.2012		FC 62 LSDPR	A522		0,9	
	NEW 1.4 TSI	CZCA	92/125	05.2015		ZN 62 LSDPFRSO	A538		0,75	
	1.6	CFNA	77/105	07.2013		FN 58 LZKFR5	A521		1,05	

SIMCA (Chrysler)										
1000	1.1					C 52 LS	A1	B1	0,6	L65
	1.3 Rallye 1					C 52 LS	A1	B1	0,6	L65
	1.3 Rallye 2					C 82 LS	A40	B6	0,6	L87
1005	0.9					C 62 LS	A4	B5	0,6	L65
1006	1.1					C 62 LS	A4	B5	0,6	L65
1100 / 1300	0.9 LE					C 52 LS	A1	B1	0,6	L65
	1.1 LE					C 52 LS	A1	B1	0,6	L65
	1.3 Ti					C 82 LS	A40	B6	0,6	L87
	1307 : 1.3					C 52 LS	A1	B1	0,6	L65
	1308 : 1.4					C 52 LS	A1	B1	0,6	L65
	1309 : 1.3 GLS					C 52 LS	A1	B1	0,6	L65
	1309 : 1.6 SX					C 52 LS	A1	B1	0,6	L65

SKODA										
100	1.0 S, L	OHV	29/39	01.1969	12.1979	C 42 S	A12	B7	0,8	N43
105.12	1.0 Estelle, S, L	742.10	33-34/45-46	08.1976	12.1990	C 42 S	A12	B7	0,8	N43
115	1.1 Favorit		37/50	01.1991		FC 62 LS (1)	A43		0,8	
120	1.2 Coupé Rapid, GLS, LS, LSE		43/58	08.1976	12.1990	C 62 S	A55		0,6	
	1.2 GL, GLE, L, LE		38/52	08.1976	12.1990	C 42 S	A12	B7	0,8	N43
130	1.3		39/53	08.1987	10.1991	C 42 S	A12	B7	0,8	N43
	1.3 L, GL	135/8	43/58	09.1984	12.1990	C 62 S	A55		0,7	
	1.3 L	742.13	45/61	02.1985	12.1990	C 62 S	A55		0,7	
	1.3 G, GL		46/63	05.1988	10.1991	C 62 S	A55		0,7	
135	1.3 L, GL			09.1984	12.1990	RFC 42 LS	A25		0,7	F54
136	1.3 L, GL			09.1984	12.1990	RFC 42 LS	A25		0,7	F54
CITIGO	NEW 1.0 CNG	CPGA	50/68	11.2012		ZN 62 LSDPFRSO	A538		0,75	
FABIA (6Y2)	1.0	ARV/AQV	37/50	12.1999	08.2002	RFC 58 LZ3EX	A58	B55	0,9	F54
	1.2	AWY/BMD	40/54	07.2001	03.2008	FN 58 LZKFR	A183		0,9	
	1.2	BME	47/64	11.2004	12.2007	FN 58 LZKFR5	A183		1,05	
	1.2	AZQ	47/64	01.2003	12.2004	FN 58 LZKFR	A521		1,0	
	1.4	AZE/AZF	44/60	08.2000	08.2002	RFN 42 LZP	A194		0,8	
	1.4 i	AME/ATZ/AQW	50/68	12.1999	05.2003	RFN 42 LZP	A194		0,8	
	1.4 16V	AUA	55/75	12.1999	08.2003	RFC 58 LZ3EX	A58	B55	0,9	F54
	1.4 16V	BKY	55/75	05.2004	12.2007	FN 58 LZKFR	A183		0,9	
	1.4 16V	BBY	55/75	04.2002	05.2004	RFN 52 LZDPF5	A153		1,1	
	1.4 16V	AUB/BBZ	74/100	12.1999	03.2008	RFC 58 LZ3EX	A58	B55	0,9	F54
	2.0	AZL	85/116	12.1999	03.2008	RFC 58 LZ3EX	A58	B55	0,9	F54
FABIA A (6Y3)	1.2	AWY/BMD	40/54	08.2002	03.2008	FN 58 LZKFR	A183		0,9	
	1.2	AZQ	47/64	01.2003	12.2004	FN 58 LZKFR	A183		0,9	
	1.2	BME	47/64	11.2004	12.2007	FN 58 LZKFR5	A521		1,05	
	1.4	AZE/AZF	44/60	08.2000	08.2002	RFN 42 LZP	A194		0,8	
	1.4 i	AME/ATZ/AQW	50/68	07.2001	05.2003	RFN 42 LZP	A194		0,8	
	1.4 16V	AUA (Boite Vitesses Manuelle)	55/75	10.1999	08.2003	RFC 58 LZ3EX	A58	B55	0,9	F54
	1.4 16V	AUA (Boite Vitesses Automatique)	55/75	10.1999	08.2003	RFN 52 LZDPF5	A153		1,1	
	1.4 16V	BBY (Boite Vitesses Manuelle)	55/75	04.2002	05.2004	RFC 58 LZ3EX	A58	B55	0,9	F54
	1.4 16V	BBY (Boite Vitesses Automatique)	55/75	04.2002	05.2004	RFN 52 LZDPF5	A153		1,1	
	1.4 16V	BKY	55/75	05.2004	12.2007	FN 58 LZKFR	A183		0,9	
	1.4 16V	BUD	59/80	05.2006	12.2007	FN 58 LZKFR5	A521		1,05	
	1.4 16V	AUB/BBZ	74/100	12.1999	12.2007	RFC 58 LZ3EX	A58	B55	0,9	F54
	2.0	AZL	85/116	12.1999	12.2007	RFC 58 LZ3EX	A58	B55	0,9	F54
FABIA Combi (6Y5)	1.0	AQV/ARV/ATY	37/50	12.1999	08.2002	RFN 52 LZDPF5	A153		1,1	

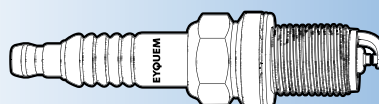

(1) Available until end of stock
 (a) 30 000 km
 (b) 60 000 km
 (c) Grey sticker on ignition coil
 (d) Green sticker on ignition coil

(e) Hex 21 mm
 (f) Hex 16 mm
 (g) Recommended for cold weather



KW/HP



Box
10

Blister
4



F3-D1

SKODA

	1.2	AWY/BMD	40/54	07.2001	12.2007	FN 58 LZKFR	A183		0,9	
	1.2	AZQ	47/64	01.2003	12.2004	FN 58 LZKFR	A183		0,9	
	1.2	BME	47/64	11.2004	12.2007	FN 58 LZKFR5	A521		1,05	
	1.4	AZE/AZF	44/60	04.2000	03.2003	RFN 42 LZP	A194		0,8	
	1.4	AME/ATZ/AQW	50/68	09.2000	05.2003	RFN 42 LZP	A194		0,8	
	1.4 16V	AUA (Boîte Vitesses Manuelle)	55/75	05.2000	05.2004	RFC 58 LZ3EX	A58	B55	0,9	F54
	1.4 16V	BBY (Boîte Vitesses Manuelle)	55/75	04.2002	05.2004	RFC 58 LZ3EX	A58	B55	0,9	F54
	1.4 16V	AUA (Boîte Vitesses Automatique)	55/75	05.2000	05.2004	RFN 52 LZDPF5	A153		1,1	
	1.4 16V	BBY (Boîte Vitesses Automatique)	55/75	04.2002	05.2004	RFN 52 LZDPF5	A153		1,1	
	1.4 16V	BKY	55/75	05.2004	12.2007	FN 58 LZKFR	A183		0,9	
	1.4 16V	BUD	59/80	04.2006	12.2007	FN 58 LZKFR5	A521		1,05	
	1.4 16V	AUB/BBZ	74/101	04.2000	12.2007	RFC 58 LZ3EX	A58	B55	0,9	F54
	2.0	AZL/AQY	85/115	04.2000	12.2007	RFC 58 LZ3EX	A58	B55	0,9	F54
FABIA Praktik	1.2	AWY/BMD	40/54	07.2001	12.2007	FN 58 LZKFR	A183		0,9	
	1.2	AZQ/BME	47/64	02.2003	12.2007	FN 58 LZKFR	A183		0,9	
	1.4	ATZ/AME/AQW	50/68	07.2001	05.2003	RFN 42 LZP	A194		0,8	
FABIA II (542)	1.2	BBM/CHFA	44/60	12.2006	12.2014	FN 58 LZKFR	A183		0,9	
	1.2	CHFA	44/60	03.2009	12.2014	FN 58 LZKFR5	A521		1,05	
	1.2	BZG/CEVA/CGPA/CHTA Chassis.Nr. 5J-83074395, 5J-8B501226 -->	51/69	01.2007	12.2014	FN 58 LZKFR5	A521		1,05	
	1.2	CEVA/BZG/CGPA	51/69	01.2007	12.2014	FN 58 LZKFR	A183		0,9	
	1.2 12V	CGPB	44/60	11.2011	12.2014	FN 58 LZKFR5	A521		1,05	
	NEW 1.2 TSI	CBZA	63/86	03.2010	12.2014	FN 68 LZPFRS	A548		0,7	
	NEW 1.2 TSI	CBZB	77/105	03.2010	12.2014	FN 68 LZPFRS	A548		0,7	
	1.4	CGGB/BXW	63/86	01.2007	12.2014	FN 58 LZKFR5	A521		1,05	
	NEW 1.4 TSI RS	CAVE/CTHE	132/180	05.2010	12.2014	FN 72 LZPFRS	A551		0,7	
	1.6	BTS/CFNA	77/105	04.2007	12.2014	FN 58 LZKFR5	A521		1,05	
FABIA II Combi (545)	1.2	CEVA/BZG/CGPA	51/69	10.2007	11.2014	FN 58 LZKFR	A183		0,9	
	1.2	CHFA	44/60	03.2009	11.2014	FN 58 LZKFR5	A521		1,05	
	1.2	BZG/CEVA Nr. Chassis -> 5J 8B501225	51/69	01.2007	12.2014	FN 58 LZKFR	A183		0,9	
	1.2	BZG/CEVA Nr. Chassis à partir 5J 8B501226	51/69	01.2007	12.2014	FN 58 LZKFR5	A521		1,05	
	1.2	CGPA/CHTA Nr. Chassis -> 5J 83074394	51/69	01.2007	12.2014	FN 58 LZKFR	A183		0,9	
	1.2	CGPA/CHTA Nr. Chassis à partir 5J 83074395	51/69	01.2007	12.2014	FN 58 LZKFR5	A521		1,05	
	1.2 12V	CGPB	44/60	11.2011	12.2014	FN 58 LZKFR5	A521		1,05	
	NEW 1.2 TSI	CBZA	63/86	03.2010	12.2014	FN 68 LZPFRS	A548		0,7	
	NEW 1.2 TSI	CBZB	77/105	03.2010	12.2014	FN 68 LZPFRS	A548		0,7	
	1.4	BXW/CGGB	63/86	10.2007	12.2014	FN 58 LZKFR5	A521		1,05	
	NEW 1.4 TSI RS	CAVE/CTHE	132/180	05.2010	12.2014	FN 72 LZPFRS	A551		0,7	
	1.6	BTS/CFNA	77/105	10.2007		FN 58 LZKFR5	A521		1,05	
FABIA III (NJ3)	NEW 1.2 TSI	CJZC	66/90	08.2014		ZN 62 LSDPFRSO	A538		0,75	
	NEW 1.2 TSI	CJZD	81/110	08.2014		ZN 62 LSDPFRSO	A538		0,75	
FABIA III Break (NJ5)	NEW 1.2 TSI	CJZC	66/90	10.2014		ZN 62 LSDPFRSO	A538		0,75	
	NEW 1.2 TSI	CJZD	81/110	10.2014		ZN 62 LSDPFRSO	A538		0,75	
FAVORIT	1.1		38/52	10.1990		FC 42 LS	A15	B14	0,8	F54
	135ie : 1.3 i			07.1993		RFC 52 LS	A3	B16	0,7	F54
	136ie : 1.3 i	A02 [OHV] Cat	40-50/54-68	08.1992		RFC 52 LS	A3	B16	0,7	F54
	136ie : 1.3 i			07.1993		RFC 42 LS	A25		0,7	F54
FAVORIT (781)	1.3	781.135 E	40/54	10.1990	09.1994	RFC 42 LS	A25		0,7	F54
	1.3 (135)	781.135	44/60	12.1991	06.1995	FC 42 LS	A15	B14	0,7	F54
	1.3 (136)	OHC	45/61	08.1991	06.1995	FC 42 LS	A15	B14	0,7	F54
	1.3 135	781.135	42/57	12.1991	09.1994	FC 42 LS	A15	B14	0,7	F54
	1.3 135 L	781.135	43/58	05.1989	09.1994	FC 52 LS	A25	B9	0,7	F54
	1.3 135 L	781.135	43/58	05.1989	09.1994	FN 52 LS	A41		0,7	F54
	1.3 135	781.135	44/60	10.1990	09.1994	FC 42 LS	A15	B14	0,7	F54
	1.3 135	781.135	43/58	12.1991	09.1994	FC 42 LS	A15	B14	0,7	F54

- (1) Available until end of stock
- (a) 30 000 km
- (b) 60 000 km
- (c) Grey sticker on ignition coil
- (d) Green sticker on ignition coil

- (e) Hex 21 mm
- (f) Hex 16 mm
- (g) Recommended for cold weather



EYQUEM



Box 10
Blister 4



F3 → 1

SKODA										
	1.3 136	136 L	45/61	10.1990	09.1994	FC 42 LS	A15	B14	0,7	F54
	1.3 ie	136 B	40-50/54-68	08.1992	09.1994	RFC 52 LS	A3	B16	0,7	F54
FAVORIT Forman (785)	1.3	781.135 E	40/54	09.1991	06.1995	RFC 42 LS	A25		0,7	F54
	135 : 1.3	781.135	44/60	09.1991	06.1995	RFC 42 LS	A25		0,7	F54
	1.3	OHC	45/61	08.1991	06.1995	RFC 42 LS	A25		0,7	F54
	135, 136 : 1.3	OHC	43-46/58-63	09.1988	09.1994	RFC 42 LS	A25		0,7	F54
	1.3	136 B	50/68	01.1994	06.1995	RFC 52 LS	A3	B16	0,7	F54
FAVORIT Pick-up (787)	1.3	135 B	40/54	12.1992	06.1997	RFC 42 LS	A25		0,7	F54
	1.3	781.135	42/57	12.1992	06.1997	RFC 42 LS	A25		0,7	F54
	1.3	136 B	50/68	12.1992	06.1997	RFC 52 LS	A3	B16	0,7	F54
FELICIA I (6U1)	1.1		38/52	10.1994		RFC 52 LS	A3	B16	0,8	F54
	1.3 i SW	[OHC, OHC]-135 B	40-50/54-68	10.1994	03.1998	RFC 52 LS	A3	B16	0,8	F54
	1.3, Fun	AMG	40/54	08.1996	03.1998	RFN 42 LZP	A194		0,8	
	1.3	AMJ-135 L	43/58	10.1994	03.1998	RFC 52 LS	A3	B16	0,8	F54
	1.3	AMH-136 B	50/68	10.1994	08.1996	RFC 52 LS	A3	B16	0,8	F54
	1.3	AMH-136 B	50/68	08.1996	03.1998	RFN 42 LZP	A194		0,8	
	1.6 i GLX, LX	EA111-AEE	55/75	08.1995	03.1998	RC 58 LZ3EX	A34	B54	0,9	L65
FELICIA I Break (6U5)	1.3 LX	135 B	40/54	10.1994	08.1996	RFC 52 LS	A3	B16	0,8	F54
	1.3 LX	AMG	40/54	08.1996	03.1998	RFN 42 LZP	A194		0,8	
	1.3	AMJ-135 L	43/58	10.1994	03.1998	RFC 58 LZ3EX	A58	B55	0,9	F54
	1.3 LXi	AMH-136 B	50/68	08.1995	08.1996	RFC 52 LS	A3	B16	0,8	F54
	1.3 LXi	AMH-136 B	50/68	08.1996	03.1998	RFN 42 LZP	A194		0,8	
	1.6 GLX	AEE	55/75	08.1995	03.1998	RC 58 LZ3EX	A34	B54	0,9	L65
FELICIA I Fun (797)	1.3	136B/136M/AMG	50/68	06.1997	04.2002	RFN 42 LZP	A194		0,8	
	1.3	136B/136M/AMH	50/68	06.1997	04.2002	RFN 42 LZP	A194		0,8	
	1.6	AEE	55/75	06.1997	04.2002	RC 58 LZ3EX	A34	B54	0,9	L65
FELICIA II (6U1)	1.3	AMG	40/54	01.1998	06.2001	RFN 42 LZP	A194		0,8	
	1.3	AMJ	43/58	01.1998	06.2001	RFC 52 LS	A3	B16	0,8	F54
	1.3	AMH	50/68	01.1998	06.2001	RFN 42 LZP	A194		0,8	
	1.6	AEE	55/75	01.1998	06.2001	RC 58 LZ3EX	A34	B54	0,9	L65
FELICIA II Break (6U5)	1.3	AMH	50/68	01.1998	06.2001	RFN 42 LZP	A194		0,8	
	1.6	AEE	55/75	01.1998	06.2001	RC 58 LZ3EX	A34	B54	0,9	L65
KODIAQ (NS7)	NEW 1.4 TSI	CZCA	92/125	03.2017		ZN 62 LSDPFRSO	A538		0,75	
	NEW 1.4 TSI, 4x4	CZDA/CZEA	110/150	03.2017		ZN 62 LSDPFRSO	A538		0,75	
OCTAVIA I (1U2)	1.4	AMD	44/60	04.1999	03.2001	RFN 42 LZP	A194		0,8	
	1.4 16V	AXP/BCA	55/75	09.2000	12.2010	RFC 58 LZ3EX	A58	B55	0,9	F54
	1.4 16V	AXP (Boite Vitesses Automatique)	55/75	09.2000	12.2010	RFN 52 LZDPF5	A153		1,0	
	1.6	AEE	55/75	09.1996	09.2004	RC 58 LZ3EX	A34	B54	0,9	L65
	1.6 i	AEH-AKL	74/101	02.1997	12.2007	RFC 58 LZ3EX	A58	B55	0,9	F54
	1.6 i	AVU-BFQ	75/102	11.2000	12.2010	RFC 58 LZ3EX	A58	B55	0,9	F54
	1.8 i 20V	AGN [DOHC]	92/125	09.1996	07.2000	RFC 58 LZ3EX	A58	B55	0,9	F54
	1.8 T	AGU/ARZ/ARX/AUM	110/150	08.1997	12.2010	FN 58 LZDPR	A198		0,75	
	1.8 T 4x4	ARX	110/150	05.2001	05.2006	FN 58 LZDPR	A198		0,75	
	RS 1.8 T	AUQ	132/180	05.2001	01.2006	FN 58 LZDPR	A198		0,75	
	2.0 i	AQY/APK/AZH/AEG	85/115	06.1999	07.2007	RFC 58 LZ3EX	A58	B55	0,9	F54
	2.0 i	AZJ	85/115	03.2002	09.2004	RFN 52 LZDPF5	A153		1,0	
	2.0	ATF	88/120	09.1996		RFN 52 LZDPF5	A153		1,0	
OCTAVIA I Combi (1U5)	1.4 16V	AXP/BCA (Boite Vitesses Mécanique)	55/75	08.2000	12.2010	RFC 58 LZ3EX	A58	B55	0,9	F54
	1.4 16V	AXP (Boite Vitesses Automatique)	55/75	08.2000	12.2010	RFN 52 LZDPF5	A153		1,0	
	1.6	AEE	55/75	07.1998	09.2004	RC 58 LZ3EX	A34	B54	0,9	L65
	1.6	AEH/AKL	74/101	07.1998	12.2007	RFC 58 LZ3EX	A58	B55	0,9	F54
	1.6	AVU/BFQ	75/102	09.2000	12.2010	RFC 58 LZ3EX	A58	B55	0,9	F54
	1.8 20V	AGN	92/125	07.1998	07.2000	RFC 58 LZ3EX	A58	B55	0,9	F54
	1.8 T	AGU	110/150	08.1997		RFC 58 LZ3EX	A58	B55	0,9	F54
	1.8 T	ARZ/ARX/AUM	110/150	07.1998	12.2010	FN 58 LZDPR	A198		0,75	
	1.8 T 4x4	ARX	110/150	05.2001	05.2006	FN 58 LZDPR	A198		0,75	
	RS 1.8 T	AUQ	132/180	08.2002	01.2006	FN 58 LZDPR	A198		0,75	
	2.0	AQY/APK/AZH/AEG	85/116	04.1999	05.2007	RFC 58 LZ3EX	A58	B55	0,9	F54
	2.0	AZJ	85/116	03.2002	01.2006	RFN 52 LZDPF5	A153		1,0	
	2.0 4x4	AZH	85/116	08.2000	09.2004	RFC 58 LZ3EX	A58	B55	0,9	F54
	2.0 4x4	AZJ	85/116	08.2000	09.2004	RFN 52 LZDPF5	A153		1,0	
	2.0 4x4	ATF	88/120	01.2000	12.2010	RFN 52 LZDPF5	A153		1,0	

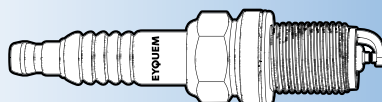

(1) Available until end of stock

- (a) 30 000 km
- (b) 60 000 km
- (c) Grey sticker on ignition coil
- (d) Green sticker on ignition coil

- (e) Hex 21 mm
- (f) Hex 16 mm
- (g) Recommended for cold weather



Box
10

Blister
4



F3-1

SKODA

OCTAVIA II (1Z3)	NEW 1.2 TSI	CBZB	77/105	02.2010	10.2013	FN 68 LZIFRS	A548		0,7		
	1.4	BCA	55/75	06.2004	05.2006	RFC 58 LZ3EX	A58	B55	0,9	F54	
	1.4	BUD/CGGA	59/80	06.2004	04.2013	FN 58 LZKFR	A183		0,9		
	1.4	CGGA	59/80	05.2006	03.2013	FN 58 LZKFR5	A521		1,05		
	1.4 TSI	CAXA	90/122	11.2008	06.2013	FC 62 LSDPR	A522		0,9		
	1.6	BGU/BSE/BSF/CCSA/CMXA	75/102	06.2004	06.2013	RFC 58 LZ3EX	A58	B55	0,9	F54	
	1.6 LPG	CHGA	75/102	08.2009	11.2012	RFC 58 LZ3EX	A58	B55	0,9	F54	
	1.6 MultiFuel	CCSA	75/102	01.2008	06.2013	RFC 58 LZ3EX	A58	B55	0,9	F54	
	1.8 TSI	BZB/CDA	118/161	06.2007	04.2013	FN 68 LZDPR	A523		0,7		
	2.0 FSI	BLY/BVZ	110/150	11.2004	10.2008	RFN 58 LZDP5	A187		1,1		
	2.0 FSI	BLR/BVY	110/150	11.2004	10.2008	FN 62 LZFDPR2A	A192		1,1		
	2.0 RS	BWA/CCZA	147/200	10.2005	02.2013	FN 68 LZDPR	A523		0,7		
	OCTAVIA II Combi (1Z5)	NEW 1.2 TSI	CBZB	77/105	02.2010	04.2013	FN 68 LZIFRS	A548		0,7	
	1.4	BCA	55/75	05.2004	05.2006	RFC 58 LZ3EX	A58	B55	0,9	F54	
1.4	BUD/CGGA	59/80	05.2006	06.2013	FN 58 LZKFR	A183		0,9			
1.4	Nr Chassis ->1Z 400 000										
1.4	BUD/CGGA	59/80	05.2006	06.2013	FN 58 LZKFR5	A521		1,05			
1.4 TSI	Nr Chassis à partir 1Z 400 001										
1.4 TSI	CAXA	90/122	11.2008	06.2013	FC 62 LSDPR	A522		0,9			
1.6	BGU/BSE/BSF/CCSA/CMXA	75/102	06.2004	06.2013	RFC 58 LZ3EX	A58	B55	0,9	F54		
1.6 MultiFuel	CCSA	75/102	01.2008	06.2013	RFC 58 LZ3EX	A58	B55	0,9	F54		
1.6 LPG	CHGA	75/102	08.2009	11.2012	RFC 58 LZ3EX	A58	B55	0,9	F54		
1.8 TSI 4x4	CDAB	112/152	03.2009	02.2013	FN 68 LZDPR	A523		0,7			
1.8 TSI	BZB/CDA	118/160	06.2007	04.2013	FN 68 LZDPR	A523		0,7			
1.8 TSI 4x4	CDA	118/160	11.2008	02.2013	FN 68 LZDPR	A523		0,7			
2.0 FSI	BLY/BVZ	110/150	11.2004	10.2008	RFN 58 LZDP5	A187		1,1			
2.0 FSI	BLR/BVY	110/150	11.2004	10.2008	FN 62 LZFDPR2A	A192		1,1			
2.0 FSI 4x4	BLX/BVX	110/150	11.2004	10.2008	FN 62 LZFDPR2A	A192		1,1			
2.0 RS	BWA/CCZA	147/200	10.2005	02.2013	FN 68 LZDPR	A523		0,7			
OCTAVIA III (5E3)	NEW 1.2 TSI	CJZB	63/86	11.2012		ZN 62 LSDPFRSO	A538		0,75		
	NEW 1.2 TSI	CJZA	77/105	11.2012		ZN 62 LSDPFRSO	A538		0,75		
	NEW 1.2 TSI	CYVB	81/110	05.2015		ZN 62 LSDPFRSO	A538		0,75		
	NEW 1.4 TSI G-TEC	CPWA	81/110	11.2013		ZN 62 LSDPFRSO	A538		0,75		
	NEW 1.4 TSI	CHPA	103/140	11.2012		ZN 62 LSDPFRSO	A538		0,75		
	NEW 1.4 TSI	CZDA	110/150	08.2014		ZN 62 LSDPFRSO	A538		0,75		
	NEW 1.8 TSI	CJSA	132/180	11.2012		FN 72 HZIPRSO	A537		0,75		
	NEW 1.8 TSI 4x4	CJSB	132/180	09.2014		FN 72 HZIPRSO	A537		0,75		
	NEW 2.0 TSI RS	CHHB	162/220	05.2013		FN 72 HZIPRSO	A537		0,75		
	NEW 2.0 TSI RS	CHHA	169/230	05.2015		FN 72 HZIPRSO	A537		0,75		
	OCTAVIA Combi (5E5)	NEW 1.2 TSI	CJZB	63/86	11.2012		ZN 62 LSDPFRSO	A538		0,75	
	NEW 1.2 TSI	CJZA	77/105	11.2012		ZN 62 LSDPFRSO	A538		0,75		
	NEW 1.2 TSI	CYVB	81/110	05.2015		ZN 62 LSDPFRSO	A538		0,75		
	NEW 1.4 TSI G-TEC	CPWA	81/110	11.2013		ZN 62 LSDPFRSO	A538		0,75		
NEW 1.4 TSI	CHPA	103/140	11.2012		ZN 62 LSDPFRSO	A538		0,75			
NEW 1.4 TSI	CZDA	110/150	08.2014		ZN 62 LSDPFRSO	A538		0,75			
NEW 1.8 TSI, 4x4	CJSB/CJSA	132/180	11.2012		FN 72 HZIPRSO	A537		0,75			
NEW 2.0 TSI RS	CHHB	162/220	11.2012		FN 72 HZIPRSO	A537		0,75			
NEW 2.0 TSI RS	CHHA	169/230	05.2015		FN 72 HZIPRSO	A537		0,75			
RAPID	1.2	120 G	43/58	02.1983	12.1990	C 32 S	A8		0,7	N43	
	1.3	130 G	39/53	08.1987	10.1991	C 32 S	A8		0,7	N43	
	130 : 1.3	742...	43/58		08.1988	C 62 S	A55		0,9		
	135, 136 : 1.3	742...	45/61	09.1984	12.1990	FC 42 LS	A15	B14	0,9	F54	
RAPID (NH3)	1.2	CGPC	55/75	07.2012		FN 58 LZKFR5	A521		1,05		
	NEW 1.2 TSI	CBZA	63/86	07.2012		FN 68 LZIFRS	A548		0,7		
	NEW 1.2 TSI	CJZC	66/90	05.2015		ZN 62 LSDPFRSO	A538		0,75		
	NEW 1.2 TSI	CBZB	77/105	07.2012		FN 68 LZIFRS	A548		0,7		
	NEW 1.2 TSI	CJZD	81/110	05.2015		ZN 62 LSDPFRSO	A538		0,75		
	1.4 TSI	CAXA	90/122	07.2012		FC 62 LSDPR	A522		0,9		
	NEW 1.4 TSI	CZCA	92/125	05.2015		ZN 62 LSDPFRSO	A538		0,75		
	1.6	CFNA	77/105	07.2012	06.2015	FN 58 LZKFR5	A521		1,05		
RAPID Spaceback (NH1)	NEW 1.2	CGPC	55/75	07.2012		FN 58 LZKFR	A183		0,9		
NEW 1.2 TSI	CBZA	63/86	07.2012		FN 68 LZIFRS	A548		0,7			

(1) Available until end of stock

(a) 30 000 km

(b) 60 000 km

(c) Grey sticker on ignition coil

(d) Green sticker on ignition coil

(e) Hex 21 mm

(f) Hex 16 mm

(g) Recommended for cold weather

(g) Recommended for cold weather



EYQUEM



Box
10

Blister
4



F3

SKODA											
	NEW	1.2 TSI	CJZC	66/90	05.2015		ZN 62 LSDPFRSO	A538	0,75		
	NEW	1.2 TSI	CBZB	77/105	07.2012		FN 68 LZPFRS	A548	0,7		
	NEW	1.2 TSI	CJZD	81/110	05.2015		ZN 62 LSDPFRSO	A538	0,75		
		1.4 TSI	CAXA	90/122	07.2012		FC 62 LSDPR	A522	0,9		
	NEW	1.4 TSI	CZCA	92/125	05.2015		ZN 62 LSDPFRSO	A538	0,75		
		1.6	CFNA	77/105	07.2012	06.2015	FN 58 LZKFR5	A521	1,05		
ROOMSTER (5J)		1.2	BME	47/64	05.2006	01.2007	FN 58 LZKFR	A183	0,9		
		1.2	BZG	51/69	01.2007	05.2009	FN 58 LZKFR	A183	0,9		
			Nr Chassis -> 5J 8B501225								
		1.2	BZG	51/69	01.2007	05.2009	FN 58 LZKFR5	A521	1,05		
			Nr Chassis à partir de 5J 8B501226								
		1.2	CGPA	51/69	03.2009	03.2010	FN 58 LZKFR5	A521	1,05		
	NEW	1.2 TSI	CBZA	63/86	03.2010	05.2015	FN 68 LZPFRS	A548	0,7		
	NEW	1.2 TSI	CBZB	77/105	03.2010	05.2015	FN 68 LZPFRS	A548	0,7		
		1.4	BXW/CGGB	63/86	09.2006	05.2015	FN 58 LZKFR5	A521	1,05		
		1.6	BTS/CFNA	77/105	09.2006	05.2015	FN 58 LZKFR5	A521	1,05		
ROOMSTER Praktik (5J)		1.2	BZG	51/69	01.2007	05.2009	FN 58 LZKFR	A183	0,9		
			Nr Chassis -> 5J 8B501225								
		1.2	BZG	51/69	01.2007	05.2009	FN 58 LZKFR5	A521	1,05		
			Nr Chassis à partir de 5J 8B501226								
		1.2	CGPA	51/69	03.2009	03.2010	FN 58 LZKFR5	A521	1,05		
	NEW	1.2 TSI	CBZA	63/86	03.2010	05.2015	FN 68 LZPFRS	A548	0,7		
		1.4	BXW/CGGB	63/86	03.2007	05.2015	FN 58 LZKFR5	A521	1,05		
SUPERB (3U4)		1.8 T	AWT	110/150	12.2001	03.2008	FN 58 LZDPR	A198	0,75		
		2.0	AZM	85/115	12.2001	03.2008	RFC 58 LZ3EX	A58	B55	0,9 F54	
		2.8 V6	AMX	142/193	12.2001	03.2008	RFC 62 LZ2	A150		1,0 F86	
SUPERB Break (3T4)		1.4 TSI	CAXC	92/125	07.2008	05.2015	FC 62 LSDPR	A522	0,9		
		1.8 TSI, 4x4	BZB/CDA	118/161	03.2008	05.2015	FN 68 LZDPR	A523	0,7		
		1.8 TSI	CDAB	112/153	03.2009	04.2010	FN 68 LZDPR	A523	0,7		
		2.0 TSI	CCZA	147/200	05.2010	05.2015	FN 68 LZDPR	A523	0,7		
SUPERB III (3V3)	NEW	1.4 TSI	CZCA	92/125	03.2015		ZN 62 LSDPFRSO	A538	0,75		
	NEW	1.4 TSI	CZDA/CZEA	110/150	05.2015		ZN 62 LSDPFRSO	A538	0,75		
	NEW	1.4 TSI 4x4	CZEA	110/150	03.2015		ZN 62 LSDPFRSO	A538	0,75		
	NEW	1.8 TSI	CJSA/CJSC	132/180	05.2015		FN 72 HZIPRSO	A537	0,75		
	NEW	2.0 TSI	CHHB	162/220	03.2015		FN 72 HZIPRSO	A537	0,75		
SUPERB III break (3V5)	NEW	1.4 TSI	CZCA	92/125	03.2015		ZN 62 LSDPFRSO	A538	0,75		
	NEW	1.4 TSI	CZDA/CZEA	110/150	05.2015		ZN 62 LSDPFRSO	A538	0,75		
	NEW	1.4 TSI 4x4	CZEA	110/150	03.2015		ZN 62 LSDPFRSO	A538	0,75		
	NEW	1.8 TSI	CJSA/CJSC	132/180	05.2015		FN 72 HZIPRSO	A537	0,75		
	NEW	2.0 TSI	CHHB	162/220	03.2015		FN 72 HZIPRSO	A537	0,75		
YETI (5L)	NEW	1.2 TSI	CBZB	77/105	09.2009		FN 68 LZPFRS	A548	0,7		
	NEW	1.2 TSI	CYVB	110/150	05.2015		ZN 62 LSDPFRSO	A538	0,75		
		1.4 TSI	CAXA	90/122	06.2010		FC 62 LSDPR	A522	0,9		
	NEW	1.4 TSI	CZCA	92/125	05.2015		ZN 62 LSDPFRSO	A538	0,75		
	NEW	1.4 TSI 4x4	CZDA	110/150	05.2015		ZN 62 LSDPFRSO	A538	0,75		
		1.8 TSI 4x4	CDAB	112/152	11.2009		FN 68 LZDPR	A523	0,7		
		1.8 TSI 4x4	CDA	118/160	05.2009		FN 68 LZDPR	A523	0,7		
SMART											
SMART		0.6	M 160 E6AL B04	33/45	07.1998		RFC 58 LZ2E	A10	B31	0,9 F54	
		0.6 Turbo	M 160 E6AL B03	40/54	07.1998		RFC 58 LZ2E	A10	B31	0,9 F54	
		0.6 Turbo	M 160 E6AL B05	45/61	01.2001		RFC 58 LZ2E	A10	B31	0,9 F54	
FORFOUR (454)		1.1 (454.033)	M 134.911	47/64	02.2005	06.2006	RFC 58 HZEDP5	A191		1,1	
		1.1 (454.030)	M 134.910	55/75	01.2004	06.2006	RFC 58 HZEDP5	A191		1,1	
		1.3 (454.031)	M 135.930	70/95	01.2004	06.2006	RFC 58 HZEDP5	A191		1,1	
FORFOUR		1.5 (454.032)	M 135.950	80/109	01.2004	06.2006	RFC 58 HZEDP5	A191		1,1	
		1.5 (454.032)	M 135.950	90/122	01.2004	06.2006	RFC 58 HZEDP5	A191		1,1	
CABRIO (450)	NEW	0.7 (450.452, 450.432)	M 160 920	45/61	01.2003	01.2004	RZC 68 HS2	A552		0,6	
	NEW	0.7 (450.433)	M 160 920	55/75	01.2003	01.2004	RZC 68 HS2	A552		0,6	
CITY-COUPE (450)	NEW	0.7 (450.330)	M 160 920	37/50	01.2003	01.2004	RZC 68 HS2	A552		0,6	
	NEW	0.7 (450.333)	M 160 920	55/75	01.2003	01.2004	RZC 68 HS2	A552		0,6	
	NEW	0.7 (450.352, 450.353)	M 160 920	45/61	01.2003	01.2004	RZC 68 HS2	A552		0,6	

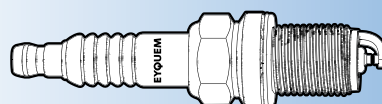

- (1) Available until end of stock
- (a) 30 000 km
- (b) 60 000 km
- (c) Grey sticker on ignition coil
- (d) Green sticker on ignition coil

- (e) Hex 21 mm
- (f) Hex 16 mm
- (g) Recommended for cold weather



Box
10

Blister
4



F3

SMART

FORTWO Cabrio (450)	NEW 0.7 (450.452)	M 160 920	45/61	01.2004	01.2007	RZC 68 HS2	A552	0,6
	NEW 0.7 (450.433)	M 160 920	55/75	01.2004	01.2007	RZC 68 HS2	A552	0,6
FORTWO Cabrio (453)	NEW 1.0 (453.442, 453.443)	M 281.920	52/71	09.2015		RWC 58 HSEW	A530	0,9
FORTWO Coupe (450)	NEW 0.7 (450.330)	M 160 920	37/50	01.2004	01.2007	RZC 68 HS2	A552	0,6
	NEW 0.7 (450.352, 450.332)	M 160 920	45/61	01.2004	01.2007	RZC 68 HS2	A552	0,6
	NEW 0.7 (450.333)	M 160 920	55/75	01.2004	01.2007	RZC 68 HS2	A552	0,6
FORTWO Coupe (453)	NEW 1.0 (453.341)	M 281.920	45/60	11.2014		RWC 58 HSEW	A530	0,9
	NEW 1.0 (453.342, 453.343)	M 281.920	52/71	07.2014		RWC 58 HSEW	A530	0,9
FORFOUR (453)	NEW 1.0 (453.041)	M 281.920	45/60	11.2014		RWC 58 HSEW	A530	0,9
	NEW 1.0 (453.042)	M 281.920 (H4DA401)	52/71	07.2014		RWC 58 HSEW	A530	0,9
ROADSTER (452)	NEW 0.7 (452.432)	M 160 921	45/61	04.2003	11.2005	RZC 68 HS2	A552	0,6
	NEW 0.7 (452.434)	M 160 922	60/82	04.2003	11.2005	RZC 68 HS2	A552	0,6
	NEW 0.7 Brabus (452.437)	M 160 923	74/101	12.2003	11.2005	RZC 68 HS2	A552	0,6
ROADSTER Coupe(452)	NEW 0.7 (452.332)	M 160 922	45/61	06.2003	11.2005	RZC 68 HS2	A552	0,6
	NEW 0.7 (452.334)	M 160 921	60/82	04.2003	11.2005	RZC 68 HS2	A552	0,6
	NEW 0.7 Brabus (452.337)	M 160 923	74/101	12.2003	11.2005	RZC 68 HS2	A552	0,6

SSANGYONG

KORANDO	2.3 i	M161 [DOHC]	103/140	06.1997		FC 42 LS	A15	B14	0,8	F54
	3.2	M 104.995	162/220	12.1996		FC 42 LS	A15	B14	0,8	F54
	3.2 i V6 SEL		154-162/209-220	06.1997		FC 42 LS	A15	B14	0,8	F54
MUSSO	2.0	E20	93/126	10.1996		FC 42 LS	A15	B14	0,8	F54
	2.0 i	M161.940	100/136	05.1996		FC 42 LS	A15	B14	0,8	F54
	2.3	M 111.970	103/140	10.1996		FC 42 LS	A15	B14	0,8	F54
	2.3 i 16V	M161.970	103-110/140-150	05.1996		FC 42 LS	A15	B14	0,8	F54
	3.2	M 104.992	162/220	06.1996		FC 42 LS	A15	B14	0,8	F54
	3.2 i V6 24V	M162.990	162/220	05.1996		FC 42 LS	A15	B14	0,8	F54
REXTON	3.2		162/220	04.2002		FC 42 LS	A15	B14	0,8	F54

STEYR (Steyr-Daimler-Puch AG)

CITY BUS	2.3 i	B 230 F Cat	85/115	01.1991		RC 62 LS	A6	B17	0,7	L65
----------	-------	-------------	--------	---------	--	----------	----	-----	-----	-----

SUBARU

1300	1.3 i Combi, DL, STD	EA65 [OHV]		09.1980		C 62 LS	A4	B5	0,8	L65
1400	1.4 i DL, GFT, GL	EA63			08.1980	C 62 LS	A4	B5	0,8	L65
1600	1.6 4WD, DL, GL, GLF, GF, GFT, SRX, Combi, 4WD	EA71		05.1979		RC 62 LS	A6	B17	0,8	L65
1800	1.8 4WD, Combi, 4WD	EA81		05.1979		RC 62 LS	A6	B17	0,8	L65
	1.8 i 4WD, Combi 4WD	EA82 E Cat	72/98	01.1988		RC 62 LS	A6	B17	0,8	L65
	1.8 i Turbo 4WD, Combi	EA82 Cat	88-100/120-136	11.1984		RC 62 LS5	A24		1,1	L65-5
1800 XT COUPE	1.8 i Turbo 4WD,	EA82 Cat	88-100/120-136	11.1984		RC 62 LS5	A24		1,1	L65-5
	1.8 Turbo 4WD,	EA82	88/120	01.1988	12.1990	RC 72 LS	A32	B26	0,8	L87
ALCYONE	1.8 i Turbo	EA82 Cat	88/120	08.1985	09.1991	RC 62 LS5	A24		1,1	L65-5
DOMINGO	1.0	EF10	55/75	06.1983	06.1994	RC 62 LS5	A24		1,1	L65-5
	1.2 i	EF12	55/75	07.1986	06.1994	RC 62 LS5	A24		1,1	L65-5
FORESTER	2.0	EJ20	90/122	08.1997	09.2002	RFC 42 LS5	A83		1,1	F54-5
	2.0	EJ20	92/125	06.1998	09.2002	RFC 42 LS5	A83		1,1	F54-5
	2.0 i 16V	EJ20 [DOHC] Cat	85/115	02.1997		RFC 58 LS5	A38	B48	1,1	F54-5
	2.0 i 16V	EJ20 JE [SOHC] Cat	90/122	07.1997	07.1998	RFC 52 LS5	A26	B24	1,1	F54-5
	2.0 i 16V	EJ20 [SOHC] Cat	85/115	08.1997	08.1998	RFC 52 LS5	A26	B24	1,1	F54-5
	2.5 i 16V	EJ25 [SOHC]	115/156	08.1997		RFC 52 LS5	A26	B24	1,1	F54-5
IMPREZA	1.5 i 16V	EJ15 [SOHC]	72-75/97-102	11.1992	08.2000	RFC 58 LS5	A38	B48	1,1	F54-5
	1.6 i 16V 4WD	EJ16 [SOHC] Cat	66-70/90-95	08.1992	09.1996	RFC 58 LS5	A38	B48	1,1	F54-5
	1.6 i 16V 4WD	EJ16 E [SOHC] Cat	66-70/90-95	08.1992		RFC 58 LS5	A38	B48	1,1	F54-5
	1.8 i 16V	EJ18	76/103	08.1992	12.2000	RFC 58 LS5	A38	B48	1,1	F54-5
	1.8 i 16V 4WD	EJ18 E [SOHC] Cat	76/103	08.1992	06.1997	RFC 58 LS5	A38	B48	1,1	F54-5
	2.0 i 16V	EJ20 [SOHC] Cat	85/115	08.1992	08.1998	RFC 52 LS5	A26	B24	1,1	F54-5
	2.0 i 16V	EJ20 [DOHC] Cat	85/115	08.2000		RFC 58 LS5	A38	B48	1,1	F54-5
	2.0 Turbo GT 4WD (GC)	EJ20 (Turbo)	155/211	03.1994	12.2000	RFN 58 LZDP5	A187		1,1	
IMPREZA II	1.6 AWD	EJ16	70/95	12.2000		RFC 52 LS5	A26	B24	1,1	F54-5

(f) Available until end of stock

(a) 30 000 km

(b) 60 000 km

(c) Grey sticker on ignition coil

(d) Green sticker on ignition coil

(e) Hex 21 mm

(f) Hex 16 mm

(g) Recommended for cold weather



EYQUEM



Box
10

Blister
4



F3

SUBARU

	2.0 i 16V	EJ20 [SOHC] Cat	92/125	12.2000		RFC 52 LS5	A26	B24	1,1	F54-5
	2.0 WRX Turbo	EJ205	160/218	12.2000		FN 58 LZDPR	A198		0,75	
	2.0 WRX Turbo	EJ205	165/225	12.2002		FN 58 LZDPR	A198		0,75	
	2.0 WRX STi	EJ207	195/265	11.2001		RFC 62 LSDP5	A507		1,1	
	2.2 i 16V	EJ22 E [OHC] Cat	96-102/130-139			RFC 58 LS5	A38	B48	1,1	F54-5
	2.5 i 16V	EJ25 [SOHC]	122/165			RFC 52 LS5	A26	B24	1,1	F54-5
IMPREZA Station Wagon	2.0 Turbo GT 4WD	EJ20 (Turbo)	155/211	03.1994	12.2000	RFN 58 LZDP5	A187		1,1	
	2.0 Turbo	EJ205	160/218	12.2000		RFC 62 LSDP5	A507		1,1	
JUSTY	1.0 4WD	EF10	37-41/50-56	10.1984		RC 62 LS5	A24		1,1	L65-5
	1.0		51/69	01.2007		RFC 58 HZEDP5	A191		1,1	
	1000, 4WD	EF10	40/54	11.1984	12.1990	RC 62 LS	A6	B17	0,8	L65
	1000, 4WD	EF10	37/50	05.1987	11.1994	RC 62 LS	A6	B17	0,8	L65
	1.2 i 4WD	EF12	49-50/67-68	05.1987		RC 62 LS5	A24		1,1	L65-5
	1.2 i GLi, 4WD	EF12	55/75	05.1991		RC 62 LS5	A24		1,1	L65-5
	1.3 i 4WD	G13B Cat	50/68	10.1995		RC 62 LS	A6	B17	0,8	L65
LEGACY	1.6	EA71	54/73			RC 62 LS	A6	B17	0,8	L65
	1.6 i 16V	EJ16 [SOHC] Cat	66/90	05.1990	12.1993	RFC 58 LS5	A38	B48	1,1	F54-5
	1.8 i 16V	EJ18 E [SOHC] Cat	76/103	07.1995		RFC 58 LS5	A38	B48	1,1	F54-5
	1.8 i 16V 4WD	EJ18	76/103	01.1989	09.1993	RFC 58 LS5	A38	B48	1,1	F54-5
	1.8 i 16V 4WD, Station, Super Station	EJ18 SPI Cat	76/103	01.1989	12.1993	RFC 58 LS5	A38	B48	1,1	F54-5
	2.0 i 16V	EJ20 [DOHC] Cat	85/115	02.1989	09.1993	RFC 58 LS5	A38	B48	1,1	F54-5
	2.0 i 16V	EJ20 [SOHC] Cat	85/115	10.1993	08.1998	RFC 52 LS5	A26	B24	1,1	F54-5
	2.0 i 16V 4WD	EJ20 [SOHC] Cat	85/115	06.1991	09.1993	RFC 58 LS5	A38	B48	1,1	F54-5
	2.0 i 16V 4WD	EJ20 E [SOHC] Cat	85/115	05.1992		RFC 58 LS5	A38	B48	1,1	F54-5
	2.2 i 16V 4WD	EJ22 E [OHC] Cat	94-100/128-136	01.1989		RFC 58 LS5	A38	B48	1,1	F54-5
	2.2 i 16V 4WD	EJ22 [OHC] Cat	94-100/128-136	09.1993	05.1996	RFC 58 LS5	A38	B48	1,1	F54-5
	2.5		115/156	10.1998		RFC 42 LS5	A83		1,1	F54-5
	2.5 Station Wagon	EJ25	115/156	12.1998		RFC 42 LS5	A83		1,1	F54-5
	2000 Turbo 4WD	EJ20-GN	147/200	05.1992	07.1994	RFC 52 LZDP5	A149		1,1	
	2000 Turbo Super 4WD, Station Wagon	EJ20-GN	147/200	05.1992	07.1994	RFC 52 LZDP5	A149		1,1	
LEGACY IV	2.0	EJ20	101/138	09.2003		RFC 52 LS5	A26	B24	1,1	F54-5
LEONE	1300 : 1.3 i	EA65 [OHV]		01.1979	12.1985	RC 62 LS	A6	B17	0,8	L65
	1.5 i 16V	QG15DE	66/90	06.1999		RFC 52 LS5	A26	B24	1,1	F54-5
	1.6	EA71		08.1988	04.1994	RC 62 LS	A6	B17	0,8	L65
	1600 : 1.6			01.1979	12.1985	RC 62 LS	A6	B17	0,8	L65
	1.8 i 16V	QG18DE	84/114	06.1999		RFC 52 LS5	A26	B24	1,1	F54-5
	1.8 i Turbo	EA82 Cat	88/120	08.1988	01.1989	RC 62 LS5	A24		1,1	L65-5
	1800 : 1.8			01.1979	12.1985	RC 62 LS	A6	B17	0,8	L65
LIBERO	1.0 4WD	EF10	37/50	10.1983	04.1993	RC 62 LS5	A24		1,1	L65-5
	1.2 i 4WD	EF12	38/52	10.1986	04.1993	RC 62 LS5	A24		1,1	L65-5
	1.2 i 4WD, 4WD Transporter	EF12 E Cat	40/54	05.1993		RC 62 LS5	A24		1,1	L65-5
MV	1800 : 1.8	EA81	60/82	11.1984		C 62 LS	A4	B5	0,8	L65
OUTBACK	2.5		115/156	10.2000		RFC 52 LS5	A26	B24	1,1	F54-5
PLEO	0.66 i	EN07E [SOHC] Cat	35-38/48-52	10.1998		RFC 58 LS5	A38	B48	1,1	F54-5
REX	0.55	EK23	22/30	11.1986	06.1989	RFC 58 LS5	A38	B48	1,1	F54-5
	0.55	EN05	28/38	11.1986	02.1990	RFC 58 LS5	A38	B48	1,1	F54-5
	0.55 SR, SE	EK23	22-26/30-35	11.1986	06.1989	RFC 58 LS5	A38	B48	1,1	F54-5
	0.55 SG, SL, S, Vicky	EK23	22-26/30-35	11.1986	06.1989	RFC 58 LS5	A38	B48	1,1	F54-5
	500 : 0.55 Turbo Compresseur	EK23	40/54	06.1988		RFC 58 LS5	A38	B48	1,1	F54-5
	550 : 0.55	EN05	28/38	01.1989		RFC 58 LS5	A38	B48	1,1	F54-5
	550 : 0.55 Turbo Compresseur	EN05	45/61	01.1989		RFC 58 LS	A18		0,8	F54
	5-500 : 0.5	EK22				C 62 LS	A4	B5	0,8	L65
	0.66 i	EN07E [SOHC] Cat	35-38/48-52	03.1990	03.1992	RFC 58 LS5	A38	B48	1,1	F54-5
	700 : 0.7	EK42		09.1981	12.1988	RC 62 LS5	A24		1,1	L65-5
SAMBER	0.55	EK23	22/30		03.1990	RFC 58 LS5	A38	B48	1,1	F54-5
	0.66 i	EN07E [SOHC] Cat	35-38/48-52			RFC 58 LS5	A38	B48	1,1	F54-5
SVX	3.3 i 24V	EG33 [DOHC] Cat	169-176/230-239	09.1992		RFC 52 LZDP5	A149		1,1	
	3.3i 24V 4WD	EG30	162/220	09.1992	12.1997	RFN 58 LZDP5	A187		1,1	
	3.3i 24V 4WD	EG33 DOHC	169/230	09.1992	12.1997	RFN 58 LZDP5	A187		1,1	
	3.3 i 24V 4WD (CXW)	EG33 DOHC	169/230	09.1992	09.1994	RFC 62 LSDP5	A507		1,1	
	3.3 i 24V 4WD (CXW)	EG33 DOHC	162/220	09.1994	12.1997	RFC 62 LSDP5	A507		1,1	
VANILLE - LIBERO	1.2 i					RC 62 LS5	A24		1,1	L65-5
VIVIO	660 : 0.66 i, 4WD	EN07E [SOHC] Cat	35-38/48-52	03.1992	10.1998	RFC 58 LS5	A38	B48	1,1	F54-5

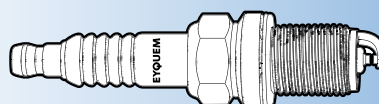

(1) Available until end of stock

- (a) 30 000 km
- (b) 60 000 km
- (c) Grey sticker on ignition coil
- (d) Green sticker on ignition coil

- (e) Hex 21 mm
- (f) Hex 16 mm
- (g) Recommended for cold weather



KW/HP

Box
10Blister
4

F3-D1

SUZUKI

ALTO	600 : 0.6 Turbo	F5A	22-30/30-41	06.1982	12.1985	RC 52 LS	A9	B20	0,8	L65	
	0.7	F6A		01.1990		RC 52 LS	A9	B20	0,8	L65	
	800 : 0.8	Y64 - F8A - F8B	27-29/37-39	10.1981		RC 52 LS	A9	B20	0,8	L65	
	1.0 i	G10B [OHC]	39-53/53-72	11.1993		RC 52 LS	A9	B20	0,8	L65	
ALTO IV	1.1	F10D - F10DN	46/63	06.2002		RZC 58 LS	A190	B59	0,9		
ALTO V	1.0	K10B	50/68	01.2009		RZC 62 LSDP5K	A518		1,1		
BALENO	1.3 i 16V	G13BB [SOHC] Cat	62-63/84-86	03.1995		RFC 58 LS	A18		0,8	F54	
	1.5 i 16V 4WD	G15A [SOHC] Cat	71/97	04.1995		RFC 58 LS	A18		0,8	F54	
	1.6 4WD	G16A [OHC] Cat	71-74/97-100	04.1995		RFC 58 LS	A18		0,8	F54	
	1.6 i 16V 4WD	G16B [OHC] Cat	71-74/97-100	04.1995		RFC 58 LS	A18		0,8	F54	
	1.8 i 16V	G18A - J18A [DOHC] Cat	89/121	09.1995		RFC 58 LS5	A38	B48	1,1	F54-5	
CAPPUCINO	660 : 0.6 12V Turbo	F6A [DOHC] Cat	47/64	09.1991		RC 62 LS5	A24		1,1	L65-5	
CARRY	0.8 ST20K / V550	LJ50				C 42 S	A12	B7	0,8	N43	
	0.8 ST80K / V800	F8A	27/37			C 52 LS	A1	B1	0,8	L65	
	0.8 ST90	F8A	27/37	10.1980	10.1985	RC 52 LS	A9	B20	0,8	L65	
	0.8 Super	F8A	27-31/37-42	01.1981		RC 52 LS	A9	B20	0,8	L65	
	1.0 SK410, SK110	F10A	30/41	10.1985		RC 52 LS	A9	B20	0,8	L65	
	1.3	G13B	58/79	03.1999		RFC 52 LS	A3	B16	0,8	F54	
CERVO	0.5	F5A	22/30	01.1980		RC 52 LS5	A36	B38	1,1	L65-5	
	0.7	F6A				RC 52 LS	A9	B20	0,8	L65	
GRAND VITARA	1.6	G16B	69/94	03.1998		RFC 52 LS	A3	B16	0,8	F54	
	2.0	J20A	94/128	03.1998		RFC 52 LS5	A26	B24	1,1	F54-5	
	2.5 V6 24V	H 25 A	106/144	04.1998		RFC 52 LS5	A26	B24	1,1	F54-5	
	1.3, 4WD	M13A	61/83	10.2000	09.2003	RFC 52 LS5	A26	B24	1,1	F54-5	
IGNIS II	1.3	M13A	69/94	09.2003		RFC 52 LS5	A26	B24	1,1	F54-5	
	1.5	M15A	73/99	09.2003		RFC 62 LSDP5	A507		1,1		
	1.5 4x4	M15A	73/99	09.2003		RFC 62 LSDP5	A507		1,1		
	1.5 Sport	M15A	80/109	12.2003		RFC 62 LSDP5	A507		1,1		
	1.3 i 16V Pack Luxe, STD	G13B Cat	59/80	10.1998		RFC 58 LS	A18		0,8	F54	
KEI	0.7	F6A		10.1998		RC 52 LS	A9	B20	0,8	L65	
LIANA	1.3	M13A	66/90	03.2002		RFC 62 LSDP5	A507		1,1		
	1.6	M16A	76/103	03.2002		RFC 62 LSDP5	A507		1,1		
	1.6 4WD	M16A	76/103	03.2002		RFC 62 LSDP5	A507		1,1		
	1.3	M13A	66/90	03.2002		RFC 52 LS5	A26	B24	1,1	F54-5	
LIANA Combi	1.3	M16A	78/106	04.2002		RFC 62 LSDP5	A507		1,1		
	1.6, 4WD	M16A	78/106	04.2002		RFC 52 LS5	A26	B24	1,1	F54-5	
	1.6 4WD	M16A	78/106	04.2002		RFC 62 LSDP5	A507		1,1		
	1.6 4WD	M16A	78/106	04.2002		RFC 62 LSDP5	A507		1,1		
	1.6 4WD	M16A	78/106	04.2002		RFC 62 LSDP5	A507		1,1		
	1.6 4WD	M16A	78/106	04.2002		RFC 62 LSDP5	A507		1,1		
	1.6 4WD	M16A	78/106	04.2002		RFC 62 LSDP5	A507		1,1		
LJ	80 : 0.8	F8A - F8B	29/39	10.1977	12.1983	RC 52 LS	A9	B20	0,8	L65	
SAMURAI	1.0	F10A	33/45	01.1988		RC 52 LS	A9	B20	0,8	L65	
	1.3	G13A [OHC]	47/64	01.1988		RC 52 LS	A9	B20	0,8	L65	
	1.3 i	G13BA		01.1988		RC 52 LS	A9	B20	0,8	L65	
	410 : 1.0	F10A	33/45	09.1981		RC 52 LS	A9	B20	0,8	L65	
SJ	410 : 1.0	F10A Cat	33/45	09.1981		RC 62 LS	A6	B17	0,8	L65	
	410 : 1.0 J, V	F10A	33/45	09.1986	12.1989	C 52 LS	A1	B1	0,8	L65	
	413 : 1.3	G13A - G13B [OHC] Cat	44-47-51/60-64-69	11.1984		RC 52 LS	A9	B20	0,8	L65	
	413 : 1.3	G13B [OHC]	44/60	01.1987	12.1989	RC 62 LS	A6	B17	0,8	L65	
	413 : 1.3	F13A				RC 62 LS	A6	B17	0,8	L65	
	SPLASH	1.0	K10B	48/65	01.2008		RZC 62 LSDP5K	A518		1,1	
		1.2	K12B	63/86	01.2008		RZC 62 LSDP5K	A518		1,1	
1.2 WVT		K12B	66/90	06.2011		RZC 62 LSDP5K	A518		1,1		
1.2 WVT		K12B	69/94	09.2010		RZC 62 LSDP5K	A518		1,1		
SWIFT	1.0	G10A [OHC]	37/50	10.1984	03.1989	C 62 LS	A4	B5	0,8	L65	
	1.0	G10A [OHC]	37-39/50-53	10.1984	03.1989	RC 62 LS	A6	B17	0,8	L65	
	1.0 i	G10A [OHC] Cat	39-41/53-56	03.1989		RC 62 LS	A6	B17	0,8	L65	
	1.3	G13B [OHC] Cat	47-50/64-68	08.1986	03.1989	RC 62 LS	A6	B17	0,8	L65	
	1.3 4WD	G13B [OHC]	49-60/67-82	03.1989		RC 62 LS	A6	B17	0,8	L65	
	1.3 GL, GLX	G13A [OHC]	47-54/64-73	10.1984	03.1989	RC 62 LS	A6	B17	0,8	L65	
	1.3 i 16V	G13B [DOHC] Cat	70-74/95-100	08.1986	03.1989	RC 62 LS	A6	B17	0,8	L65	
	1.3 i 16V GTi	G13B [DOHC] Cat	74-85/100-115	03.1989		RC 62 LS	A6	B17	0,8	L65	
	1.3 i 4WD	G13B Cat	50-52/68-71	03.1989		RC 62 LS	A6	B17	0,8	L65	
	1.6 i 16V 4WD	G16B [OHC] Cat	70/95	11.1989		RFC 58 LS	A18		0,8	F54	
	1.6 i 4WD	G16A [OHC] Cat	59/80	09.1987		RFC 58 LS	A18		0,8	F54	

(1) Available until end of stock

(a) 30 000 km

(b) 60 000 km

(c) Grey sticker on ignition coil

(d) Green sticker on ignition coil

(e) Hex 21 mm

(f) Hex 16 mm

(g) Recommended for

cold weather

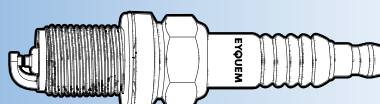

EYQUEM

209



Box 10
Blister 4



F3

SUZUKI									
SWIFT III	1.3	M13A	68/92	02.2005		RFC 62 LSDP5	A507		1.1
	1.3 4x4	M13A	68/92	02.2005		RFC 62 LSDP5	A507		1.1
	1.5	M15A	75/102	02.2005		RFC 62 LSDP5	A507		1.1
	1.6	M16A	92/125	05.2006		RFC 62 LSDP5	A507		1.1
SWIFT IV	1.2	K12B	66/90	10.2010		RFC 62 LSDP5	A507		1.1
	1.2	K12B	69/94	10.2010		RFC 62 LSDP5	A507		1.1
SX4	1.5	M15A	73/99	06.2006		RFC 62 LSDP5	A507		1.1
SX5	1.6 WT	M16A	79/107	06.2006		RFC 62 LSDP5	A507		1.1
VITARA	1.6	G16A	59/80	07.1988	01.1995	RC 62 LS	A6	B17	0,7 L65
	1.6	G16A	60/82	07.1988	12.1991	RC 62 LS	A6	B17	0,7 L65
	1.6	G16A [OHC] Cat	59-60/80-82	09.1988		RC 52 LS	A9	B20	0,8 L65
	1.6 i 16V	G16B [OHC] Cat	70-71/95-97	02.1991		RFC 58 LS	A18		0,8 F54
	2.0 i V6 24V	H20A [DOHC] Cat	100-125/136-170	11.1994		RFC 58 LS	A18		0,8 F54
	2.5 V6 24V		118/160	12.1995	03.1998	RFC 52 LS	A3	B16	0,8 F54
WAGON R	1.3 i	G13BB	56/76	05.2000		RFC 58 LS5	A38	B48	1,1 F54-5
	1.0		48/65	02.1998	05.2000	RZC 58 LS	A190	B59	0,9
	1.2		51/69	02.1998	05.2000	RZC 58 LS	A190	B59	0,9
	1.3	M13A	69/94	09.2003		RFC 62 LSDP5	A507		1.1
X-90	1.6 i 16V	G16B [OHC] Cat	71/97	09.1995		RFC 58 LS	A18		0,8 F54

TALBOT										
180	1.8					C 72 LS (1)	A30		0,7 L87	
	2.0					C 72 LS (1)	A30		0,7 L87	
AVENGER	1.6					C 62 LS	A4	B5	0,6 L65	
HORIZON	1.1 1.3 GL, GL écon., GLS, GLX, LS, S, SX					C 52 LS	A1	B1	0,6 L65	
	1.1 LS			07.1979	06.1986	C 52 LS	A1	B1	0,6 L65	
	1.3 GL			07.1979	06.1986	C 52 LS	A1	B1	0,6 L65	
	1.4 EX, GL, GLS			07.1979	06.1986	C 52 LS	A1	B1	0,6 L65	
	1.4 GL, GL écon., GLS, GLX, LS, S, SX					C 52 LS	A1	B1	0,6 L65	
	1.6 GLS, Prémium			07.1982	06.1986	C 52 LS	A1	B1	0,6 L65	
MATRA BAGHEERA	1.3 S	G4		08.1973	07.1978	C 82 LS	A40	B6	0,6 L87	
	1.4 S, X			07.1979	08.1980	C 82 LS	A40	B6	0,6 L87	
	1.4 SX	Y2 - Y4		08.1975	06.1979	C 82 LS	A40	B6	0,6 L87	
MURENA	1.6			09.1980	06.1983	C 52 LS	A1	B1	0,6 L65	
	1.6	J2A				C 52 LS	A1	B1	0,6 L65	
	2.2			09.1980	07.1984	C 52 LS	A1	B1	0,6 L65	
RANCHO	2.2	N2 - N4				C 52 LS	A1	B1	0,6 L65	
	1.4	X3Y2		03.1977	06.1979	C 52 LS	A1	B1	0,6 L65	
SAMBA	1.4 AS, Découverte, Grand Raid, X			07.1979	07.1984	C 52 LS	A1	B1	0,6 L65	
	1.0 Bahia, GL, L, LE, LS, Style, Sympa	XV5 - XV8			12.1987	C 62 LJS	A19	B2	0,6 J65	
	1.1 AS, Affaire, Bahia, Cabriolet, GL, GLS, LS, Roller, Sympa, Trio	XW7 [109..]	36/49			12.1987	C 62 LJS	A19	B2	0,6 J65
	1.2 Rallye	XZ7R			12.1987	C 72 LJS	A22		0,6 J87	
	1.4 Cabriolet, GL, GLS	XY7 [150D]	44/60			12.1987	C 62 LJS	A19	B2	0,6 J65
	1.4 Cabriolet, GL, GLS	XY6B [150]	53/72			12.1987	C 62 LJS	A19	B2	0,6 J65
SIMCA 1100	1.4 Cabriolet, GLS, Rallye, S	XY8			12.1987	C 72 LJS	A22		0,6 J87	
	Break L, LS, GL, GLS					C 52 LS	A1	B1	0,6 L65	
	ES, GL, GLA, GLE					C 52 LS	A1	B1	0,6 L65	
	Ti, Spécial (- 01/72)					C 82 LS	A40	B6	0,6 L87	
	VF1, VF2, VF3, AS					C 52 LS	A1	B1	0,6 L65	
SIMCA 1200 S	1.2 LS, GL, GLE, GLS					C 62 LS	A4	B5	0,6 L65	
SIMCA 1500	1.4					C 62 LS	A4	B5	0,6 L65	
	1.6					C 62 LS	A4	B5	0,6 L65	
SIMCA 1501	1.3 LS					C 52 LS	A1	B1	0,6 L65	
	1.4					C 52 LS	A1	B1	0,6 L65	
	1.6 SX					C 52 LS	A1	B1	0,6 L65	
SIMCA SUNBEAM	0.9					RC 62 LS	A6	B17	0,6 L65	
	1.3					RC 62 LS	A6	B17	0,6 L65	
	1.6					RC 62 LS	A6	B17	0,6 L65	
	1.6 100 PS					RC 72 LS	A32	B26	0,6 L87	
SOLARA	1.3 LS			06.1982		C 52 LS	A1	B1	0,6 L65	
	1.3 LS, 1.4, 1.6, GL, LS					C 52 LS	A1	B1	0,6 L65	
	1.4 GL, LS			05.1983		C 52 LS	A1	B1	0,6 L65	
	1.6 GL, GLX, SX			07.1986		C 52 LS	A1	B1	0,6 L65	
TAGORA	2.2 GL, GLS			06.1980	12.1983	C 52 LS	A1	B1	0,6 L65	

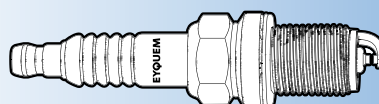

(1) Available until end of stock
(a) 30 000 km
(b) 60 000 km
(c) Grey sticker on ignition coil
(d) Green sticker on ignition coil

(e) Hex 21 mm
(f) Hex 16 mm
(g) Recommended for cold weather



Box
10

Blister
4



F3

TALBOT

2.7 SX				06.1980	12.1983	C 72 LJS	A22		0,6	J87
--------	--	--	--	---------	---------	----------	-----	--	-----	-----

TATRA

603	T2-603, T3-603	4 cyl.		01.1970		C 72 LS (1)	A30		0,7	L87
	3.5		120/163		12.1991	C 72 LS (1)	A30		0,9	L87
613-4	3.5		120/163		09.1993	RC 72 LS	A32	B26	0,9	L87
	3.5 i	Cat	147/200	10.1993		RFC 58 LS	A18		0,9	F54

TAZ

1500	1.5			10.1993	03.1994	RC 72 LS	A32	B26	0,7	L87
S 1203	1.2				12.1988	C 42 S	A12	B7	0,7	N43
S 1203 M	1.5 M			05.1985	09.1993	C 72 LS (1)	A30		0,7	L87

TOFAS

124	1.3 Serce					C 62 LS	A4	B5	0,7	L65
131	1.3 Murat, Sahin					C 62 LS	A4	B5	0,7	L65
DOGAN	1.6 Dogan SL, SLX, Kartal SL, SLX					RC 72 LS	A32	B26	0,7	L87
	1.6 Dogan, Kartal					C 62 LS	A4	B5	0,7	L65
SAHIN	1.6 Sahin					C 62 LS	A4	B5	0,7	L65
TEMPRA	1.6 ie					RC 72 LS	A32	B26	0,7	L87
	2.0 i ie					RC 72 LS	A32	B26	0,7	L87
TIPO	i Tous modèles / All models Injection			01.1994		RC 72 LS	A32	B26	0,7	L87
UNO	i Tous modèles / All models Injection			01.1995		RC 72 LS	A32	B26	0,7	L87

TOYOTA

1000	1.0	2K	33/45	04.1969	01.1981	C 52 LS	A1	B1	0,8	L65
4 RUNNER	2.4	22 R		01.1989	11.1995	RC 52 LS	A9	B20	0,8	L65
	2.4 i	22 RE Cat		01.1989	11.1995	RC 52 LS	A9	B20	0,8	L65
	2.7 i	3RZ-FE	112/152		11.1995	RFC 52 LZDP6	A156		1,3	
	3.0 iV6	3VZ-E Cat	105/143	08.1989	11.1995	RFC 52 LS	A3	B16	0,8	F54
ALTEZZA	2.0 i 16V	3S-GE - FE [DOHC]	94-129/128-175	10.1998		RFC 58 LZ5	A101		1,1	F54-5
	2.0 i 24V	1G-FE [DOHC]		10.1998		RFC 52 LS5	A26	B24	1,1	F54-5
ARISTO	3.0 i 24V	2JZ-GE Cat	156-163/212-222	10.1991	09.1996	RFC 58 LZ5	A101		1,1	F54-5
	4.0 iV8 32V	1UZ-FE		10.1992	08.1997	RFC 52 LZDP5	A149		1,1	
AURIS (_E15_)	NEW 1.33 Dual WTi	1NR-FE	73/99	01.2010	09.2012	RWN 42 HSIW	A544		1,0	
	NEW 1.33 Dual WTi	1NR-FE	74/101	05.2009	09.2012	RWN 42 HSIW	A544		1,0	
	1.4	4ZZ-FE [DOHC]	71/97	03.2007	09.2012	RFC 58 LZ5	A101		1,1	F54-5
	NEW 1.6	1ZR-FE	91/124	03.2007	09.2012	RWN 42 HSIW	A544		1,0	
	NEW 1.6	1ZR-FAE	97/132	05.2009	09.2012	RWN 42 HSIW	A544		1,0	
	NEW 1.8	2ZR-FAE	108/147	02.2009	09.2012	RWN 42 HSIW	A544		1,0	
	NEW 1.8 Hybrid	2ZR-FXE	73/99	09.2010	09.2012	RWN 42 HSIW	A544		1,0	
AURIS (_E18_)	NEW 1.3	1NR-FE	73/99	10.2012		RWN 42 HSIW	A544		1,0	
	NEW 1.6	1ZR-FAE	97/132	10.2012		RWN 42 HSIW	A544		1,0	
	NEW 1.8 Hybrid	2ZR-FXE	73/99	10.2012		RWN 42 HSIW	A544		1,0	
AURIS TOURING	NEW 1.3	1NR-FE	73/99	07.2013		RWN 42 HSIW	A544		1,0	
SPORTS(_E18_)	NEW 1.6	1ZR-FAE	97/132	07.2013		RWN 42 HSIW	A544		1,0	
	NEW 1.8 Hybrid	2ZR-FXE	73/99	07.2013		RWN 42 HSIW	A544		1,0	
AVENSIS (_T22_)	1.6	4A-FE	74/101	09.1997	10.2000	RFC 52 LZDP6	A156		1,3	
	1.6	4A-FE	81/110	09.1997	10.2000	RFC 52 LZDP6	A156		1,3	
	1.6 VVT-i	3ZZ-FE	81/110	10.2000	02.2003	RFC 52 LZDP6	A156		1,3	
	1.8	1ZZ-FE	95/129	04.2003		RFC 58 LZ5	A101		1,1	F54-5
	1.8	7A-FE	81/110	09.1997	10.2000	RFC 62 LSDP5	A507		1,1	
	1.8 VVT-i	1ZZ-FE	95/129	10.2000	02.2003	RFC 58 LZ5	A101		1,1	F54-5
	2.0 i 16V Hatchback,Combi	3S-FE [DOHC] Cat	94/128	10.1997	10.2000	RFC 58 LZ5	A101		1,1	F54-5
	2.0 VVT-i	1AZ-FSE	110/150	10.2000	02.2003	RFN 58 LZDP5	A187		1,1	
AVENSIS Liftback (_T22_)	1.6	4A-FE	74/101	09.1997	10.2000	RFC 52 LZDP6	A156		1,3	
	1.6	4A-FE	81/110	09.1997	10.2000	RFC 52 LZDP6	A156		1,3	
	1.6	3ZZ-FE	81/110	10.2000	02.2003	RFC 52 LZDP6	A156		1,3	
	1.8	7A-FE	81/110	09.1997	10.2000	RFC 62 LSDP5	A507		1,1	
	1.8	1ZZ-FE	95/129	10.2000	02.2003	RFC 58 LZ5	A101		1,1	F54-5
	2.0	3S-FE [DOHC] Cat	94/128	10.1997	10.2000	RFC 58 LZ5	A101		1,1	F54-5
	2.0	1AZ-FSE	110/150	10.2000	01.2003	RFN 58 LZDP5	A187		1,1	

(1) Available until end of stock

(a) 30 000 km

(b) 60 000 km

(c) Grey sticker on ignition coil

(d) Green sticker on ignition coil

(e) Hex 21 mm

(f) Hex 16 mm

(g) Recommended for cold weather



EYQUEM



Box
10

Blister
4



F3 → 1

TOYOTA										
AVENSIS Station Wagon (T22_)	1.6	4A-FE	74/101	09.1997	10.2000	RFC 52 LZDP6	A156		1,3	
	1.6	4A-FE	81/110	09.1997	10.2000	RFC 52 LZDP6	A156		1,3	
	1.6	3ZZ-FE	81/110	10.2000	02.2003	RFC 52 LZDP6	A156		1,3	
	1.8	7A-FE	81/110	09.1997	10.2000	RFC 62 LS DP5	A507		1,1	
	1.8	1ZZ-FE	95/129	10.2000	02.2003	RFC 58 LZ5	A101		1,1	F54-5
	2.0	3S-FE [DOHC] Cat	94/128	10.1997	10.2000	RFC 58 LZ5	A101		1,1	F54-5
	2.0	1AZ-FSE	110/150	10.2000	01.2003	RFN 58 LZ DP5	A187		1,1	
AVENSIS VERSO (M2_)	2.0	1AZ-FE	110/150	08.2001	11.2009	RFN 62 LZ DP5	A185		1,0	
AVENSIS (T25_)	1.6 VVT-i	3ZZ-FE	81/110	04.2003	11.2008	RFC 58 LZ5	A101		1,1	F54-5
	1.8	1ZZ-FE	95/129	04.2003	11.2008	RFC 58 LZ5	A101		1,1	F54-5
	2.0	1AZ-FSE	108/147	04.2003	11.2008	RFN 58 LZ DP5	A187		1,1	
	2.4	2AZ-FSE	120/163	10.2003	11.2008	RFN 58 LZ DP5	A187		1,1	
	2.4	2AZ-FSE	125/170	09.2003	11.2008	RFN 58 LZ DP5	A187		1,1	
AVENSIS A (T25_)	1.6 VVT-i	3ZZ-FE	81/110	04.2003	11.2008	RFC 58 LZ5	A101		1,1	F54-5
	1.8	1ZZ-FE	95/129	04.2003	11.2008	RFC 58 LZ5	A101		1,1	F54-5
	2.0	1AZ-FSE	108/147	04.2003	11.2008	RFN 58 LZ DP5	A187		1,1	
	2.4	2AZ-FSE	120/163	10.2003	11.2008	RFN 58 LZ DP5	A187		1,1	
	2.4	2AZ-FSE	125/170	09.2003	11.2008	RFN 58 LZ DP5	A187		1,1	
AVENSIS Station Wagon (T25_)	1.6 VVT-i	3ZZ-FE	81/110	04.2003	11.2008	RFC 58 LZ5	A101		1,1	F54-5
	1.8	1ZZ-FE	95/129	04.2003	11.2008	RFC 58 LZ5	A101		1,1	F54-5
	2.0	1AZ-FSE	108/147	04.2003	11.2008	RFN 58 LZ DP5	A187		1,1	
	2.4	2AZ-FSE	120/163	10.2003	11.2008	RFN 58 LZ DP5	A187		1,1	
	2.4	2AZ-FSE	125/170	09.2003	11.2008	RFN 58 LZ DP5	A187		1,1	
AVENSIS A (T27_)	NEW 1.6	1ZR-FAE	97/132	11.2008		RWN 42 HSIPW	A544		1,0	
	NEW 1.8	2ZR-FAE	108/147	11.2008		RWN 42 HSIPW	A544		1,0	
	NEW 2.0	3ZR-FAE	112/152	11.2008		RWN 42 HSIPW	A544		1,0	
AVENSIS Break (T27_)	NEW 1.6	1ZR-FAE	97/132	02.2009		RWN 42 HSIPW	A544		1,0	
	NEW 1.8	2ZR-FAE	108/147	02.2009		RWN 42 HSIPW	A544		1,0	
	NEW 2.0	3ZR-FAE	112/152	02.2009		RWN 42 HSIPW	A544		1,0	
AYGO (B1)	NEW 1.0 12v	1KR-FE	50/68	07.2005		RFN 58 HZ5	A534		1,15	
AYGO (B4)	NEW 1.0	1KR-FE	51/69	05.2014		RWN 42 HSIPW	A544		1,0	
b B	1.3 i 16V	2NZ-FE	63/86	12.2000		RFC 52 LS5	A26	B24	1,1	F54-5
	1.5 i 16V	1NZ-FE [DOHC]	81/110	12.2000		RFC 52 LS5	A26	B24	1,1	F54-5
CALDINA	1.5 i 16V	5E-FE [DOHC] Cat	74/101	11.1992		RFC 58 LZ5	A101		1,1	F54-5
	1.6 i 16V	4A-FE [DOHC] Cat	77/105	11.1992		RFC 58 LZ5	A101		1,1	F54-5
	1.8 i 16V	7A-FE [DOHC] Cat	85/115	11.1992		RFC 52 LZ DP6	A156		1,3	
	1.8 i 16V	4S-FE [DOHC] Cat	92/125	11.1992	01.1996	RFC 58 LZ5	A101		1,1	F54-5
	2.0 i 16V	3S-FE [DOHC] Cat	94/128	11.1992	09.1997	RFC 58 LZ5	A101		1,1	F54-5
	2.0 i 16V	3S-GE [DOHC]	129/175	02.1995	09.1997	RFC 58 LZ5	A101		1,1	F54-5
CAMI	1.3 i 16V	HC-EJ	61/83	05.1999	04.2000	RFC 58 LZ2	A54		1,0	F54
	1.3 i 16V	K3-VE [DOHC] Cat		05.2000		RFC 58 LZ5	A101		1,1	F54-5
CAMRY	1.8	1S-E		01.1983	02.1990	RC 52 LS	A9	B20	0,9	L65
	1.8 Break, Combi	1S	66/90	10.1986	08.1988	RC 52 LS	A9	B20	0,9	L65
	1.8 i	1S-L	66/90	10.1982	10.1986	RC 52 LS	A9	B20	0,9	L65
	1.8 i	1S-Ci		01.1983	02.1990	RC 52 LS	A9	B20	0,9	L65
	1.8 i	4S-Fi		08.1988	07.1990	RFC 42 LS5	A83		1,1	F54-5
	1.8 i 16V	4S-FE [DOHC] Cat	92/125	07.1990	06.1994	RFC 58 LZ5	A101		1,1	F54-5
	2.0	3S-FE	94/128	10.1987	05.1991	RFC 42 LS5	A83		1,1	F54-5
	2.0 i	2S		10.1982	10.1986	RC 52 LS	A9	B20	0,9	L65
	2.0 i	2S-ELC	72/98	01.1983	08.1986	RC 52 LS5	A36	B38	1,1	L65-5
	2.0 i	2S-ELC	73/99	04.1986	01.1988	RC 52 LS5	A36	B38	1,1	L65-5
	2.0 i	2S-ELC	77/105	01.1983	08.1986	RC 52 LS	A9	B20	0,9	L65
	2.0 i	2S-EL	79/107	03.1983	10.1986	RC 52 LS	A9	B20	0,9	L65
	2.0 i	2S-EC	73-79/99-107	01.1984	12.1986	RC 52 LS	A9	B20	0,9	L65
	2.0 GLi 16V	3S-FE	89/121	11.1986	05.1991	RFC 58 LZ5	A101		1,1	F54-5
	2.0 i 16V	3S-GE [DOHC]	129/175	08.1988	07.1990	RFC 58 LZ5	A101		1,1	F54-5
	2.0 i 16V	3S-FE [DOHC] Cat	94/128	07.1990	06.1994	RFC 58 LZ5	A101		1,1	F54-5
	2.0 i 16V Break, 4x4	3S-FE [DOHC] Cat	89-94/121-128	01.1987	05.1991	RFC 58 LZ5	A101		1,1	F54-5
	2.2	5S-FE	100/136	06.1991	08.1996	RFC 58 LZ5	A101		1,1	F54-5
	2.2	5S-FE	96/131	08.1996	11.2001	RFC 58 LZ5	A101		1,1	F54-5
	2.2 i 16V	5S-FE [DOHC] Cat	96-100/131-136	08.1996		RFC 58 LS5	A38	B48	1,1	F54-5

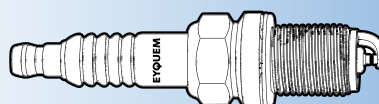

(1) Available until end of stock

- (a) 30 000 km
- (b) 60 000 km
- (c) Grey sticker on ignition coil
- (d) Green sticker on ignition coil

- (e) Hex 21 mm
- (f) Hex 16 mm
- (g) Recommended for cold weather



kW/HP



Box
10

Blister
4



F3

TOYOTA

	2.2 i 16V	5S-FE [DOHC] Cat	100/136	12.1996		RFC 58 LS5	A38	B48	1,1	F54-5
	2.2 i 16V Combi, GLi	5S-FE [DOHC] Cat	100-103/136-140	06.1991	08.1996	RFC 58 LS5	A38	B48	1,1	F54-5
	2.5 i V6 24V	2VZ-FE	118/160	02.1988	09.1991	RFC 52 LZDP5	A149		1,1	
	2.5 i V6 24V, Prominent	4VZ-FE [DOHC] Cat	130/177	02.1988	06.1994	RFC 58 LS5	A38	B48	1,1	F54-5
	3.0 24V	1MZ-FE	140/190	08.1996	11.2001	RFC 52 LS5	A26	B24	1,1	F54-5
	3.0 i 24V	3VZ-FE [DOHC] Cat	138/188	06.1991	09.1996	RFC 52 LZDP5	A149		1,1	
	3.0 (VCV10)	3VZ-FE	138/188	06.1991	08.1996	RFC 62 LSDP5	A507		1,1	
	3.0 V6	1MZ-FE	137/186	11.2001		RFC 62 LSDP5	A507		1,1	
CAMRY (_V2_)	2.2	5S-FE	93/126	11.2000	11.2001	RFN 58 LZDP5	A187		1,1	
	2.2	5S-FE	96/131	08.1996	01.2001	RFC 58 LZ5	A101		1,1	F54-5
	3.0 V6	1MZ-FE	135/184	08.1996	09.2001	RFN 58 LZDP5	A187		1,1	
CAMRY Station Wagon (_V1_)	2.2	5S-FE	100/136	03.1992	07.1996	RFC 58 LZ5	A101		1,1	F54-5
	3.0 (VCV10)	3VZ-FE	138/188	03.1992	07.1996	RFC 62 LSDP5	A507		1,1	
CAMRY Station Wagon (_V2_)	1.8	1S	66/90	11.1986	08.1988	RC 52 LS	A9	B20	0,8	L65
	2.0 GLi 16V	3S-FE	89/121	11.1986	02.1993	RFC 58 LZ5	A101		1,1	F54-5
	2.0	3S-FE	94/128	01.1987	05.1991	RFC 58 LZ5	A101		1,1	F54-5
	2.5	2VZ-FE	118/160	01.1990	05.1991	RFC 52 LZDP5	A149		1,1	
	2.2	5S-FE	100/136	06.1991	07.1996	RFC 58 LZ5	A101		1,1	F54-5
	3.0 (VCV10)	3VZ-FE	138/188	06.1991	08.1996	RFC 62 LSDP5	A507		1,1	
CAMRY A (_V3_)	2.4	2AZ-FE	112/152	11.2001	11.2006	RFN 62 LZDP5	A185		1,1	
	3.0	1MZ-FE	137/186	08.2001	11.2006	RFC 62 LSDP5	A507		1,1	
CARINA	1.6	2T	55/75	08.1972	07.1981	RC 62 LS	A6	B17	0,8	L65
	1.6 GL, ST	2T	55/75	08.1981	09.1983	RC 52 LS	A9	B20	0,8	L65
	1.6	2TB	63/86	10.1975	03.1978	RC 52 LS	A9	B20	0,8	L65
CARINA (TA4L, TA6_L)	1.6	2T	55/75	01.1978	07.1981	RC 62 LS	A6	B17	0,8	L65
	1.6	2T	55/75	08.1981	09.1983	RC 52 LS	A9	B20	0,8	L65
	1.8	3T-C	57/78	01.1978	05.1983	RC 52 LS5	A36	B38	1,1	L65-5
	1.8	3T	63/86	08.1979	09.1983	RC 52 LS	A9	B20	0,8	L65
CARINA Station Wagon (A6_)	1.6	2T	54/73	03.1981	01.1982	RC 52 LS	A9	B20	0,8	L65
	1.6	2T	55/75	04.1978	03.1983	RC 52 LS	A9	B20	0,8	L65
	1.8	3T-C	57/78	09.1982	12.1982	RC 52 LS5	A36	B38	1,1	L65-5
	1.8	3T-C	63/86	02.1980	09.1983	RC 52 LS5	A36	B38	1,1	L65-5
CARINA II	1.6	4A-FE	75/102	09.1989	03.1992	RFC 52 LZDP6	A156		1,3	
	1.6 i 16V	4A-FE [DOHC] Cat	77/105	05.1988	05.1990	RFC 52 LS5	A26	B24	1,1	F54-5
	1.6 i 16V	4A-GE [DOHC]	91/124	05.1988	08.1992	RFC 58 LZ5	A101		1,1	F54-5
	1.6 i 16V	4A-FE [DOHC] Cat	77/105	08.1996		RFC 58 LZ5	A101		1,1	F54-5
	1.6 i 16V XLi	4A-F [DOHC]	77/105	12.1987	02.1990	RFC 58 LS5	A38	B48	1,1	F54-5
	1.6 i 16V XLi Combi	4A-F [DOHC]	66-67/90-91	12.1987	09.1992	RFN 42 LZG5	A112		1,1	
	1.6 i 16V XLi, GLi	4A-FE [DOHC] Cat	77/105	11.1989	06.1991	RFC 52 LS5	A26	B24	1,1	F54-5
	1.6 i 16V XLi, GLi	4A-FE [DOHC] Cat	77/105	06.1991	11.1992	RFC 58 LZ5	A101		1,1	F54-5
	1.6 SX, XL	4A-LC Cat	52-55/71-75	10.1983	12.1987	RC 62 LS5	A24		1,1	L65-5
	1.6 XL	4A-L	63-74/86-100	10.1983	11.1987	RC 52 LS	A9	B20	0,8	L65
	1.8 i	4S-Fi		05.1988	05.1990	RFC 42 LS5	A83		1,1	F54-5
	1.8 i 16V	4S-FE [DOHC] Cat	92/125	05.1988	11.1992	RFC 58 LZ5	A101		1,1	F54-5
	2.0 i	2S-EL - 2SF	79/107	08.1985	11.1987	RC 52 LS	A9	B20	0,8	L65
	2.0 i 16V GLi	3S-FE [DOHC] Cat	89-94/121-128	12.1987	11.1992	RFC 58 LZ5	A101		1,1	F54-5
CARINA II (_T15_)	1.5	3A		01.1983		RC 62 LS	A6	B17	0,8	L65
	1.5 i	3E [SOHC]	58/79	05.1988	11.1992	RC 52 LS5	A36	B38	1,1	L65-5
	1.5 i 16V	5A-FE [DOHC]		05.1988	11.1992	RFC 52 LS5	A26	B24	1,1	F54-5
	1.6	4A-LC	55/75	10.1983	11.1987	RC 52 LS5	A36	B38	1,1	L65-5
	1.6	4A-L	62/84	10.1983	11.1987	RC 52 LS	A9	B20	0,8	L65
	1.6	4A-L	63/86	10.1986	11.1987	RC 52 LS	A9	B20	0,8	L65
	1.8	1S-L	74/101	10.1983	11.1987	RC 52 LS	A9	B20	0,8	L65
CARINA II A (_T15_)	1.6	4A-LC	55/75	10.1983	11.1987	RC 52 LS5	A36	B38	1,1	L65-5
	1.6	4A-L	62/84	10.1983	11.1987	RC 52 LS	A9	B20	0,8	L65
	1.8 GLi	1S-EL	74/101	10.1983	11.1987	RC 52 LS	A9	B20	0,8	L65
CARINA II (_T17_)	1.6	4A-F	66/90	12.1987	11.1989	RFN 42 LZG5	A112		1,1	
	1.6	4A-FE	72/98	12.1987	09.1989	RFC 52 LZDP6	A156		1,3	
	1.6	4A-FE	75/102	09.1989	03.1992	RFC 52 LZDP6	A156		1,3	
	2.0 GLi	3S-FE	89/121	01.1988	01.1992	RFC 58 LZ5	A101		1,1	F54-5
CARINA II A (_T17_)	1.6	4A-F	66/90	12.1987	08.1990	RFN 42 LZG5	A112		1,1	
	1.6	4A-FE	72/98	12.1987	09.1989	RFC 52 LZDP6	A156		1,3	

(1) Available until end of stock

(a) 30 000 km

(b) 60 000 km

(c) Grey sticker on ignition coil

(d) Green sticker on ignition coil

(e) Hex 21 mm

(f) Hex 16 mm

(g) Recommended for cold weather



EYQUEM



Box
10

Blister
4



F3-1

TOYOTA										
	1.6	4A-FE	75/102	12.1987	03.1992	RFC 52 LZDP6	A156		1,3	
	2.0 GLI	3S-FE	89/121	12.1987	01.1992	RFC 58 LZ5	A101		1,1	F54-5
CARINA II Station Wagon (_T17_)	1.6	4A-F	66/90	12.1987	12.1989	RFN 42 LZG5	A112		1,1	
	1.6	4A-FE	72/98	12.1987	09.1989	RFC 52 LZDP6	A156		1,3	
	1.6	4A-FE	75/102	12.1987	09.1989	RFC 52 LZDP6	A156		1,3	
	2.0	3S-FE	89/121	12.1987	04.1992	RFC 58 LZ5	A101		1,1	F54-5
CARINA III	1.5 i 16V	5A-FE [DOHC]		08.1996		RFC 52 LS5	A26	B24	1,1	F54-5
	1.6 i 16V	4A-FE - 4A-GE [DOHC] Cat	77-91/105-124	08.1996		RFC 58 LZ5	A101		1,1	F54-5
	1.8 i 16V	7A-FE [DOHC] Cat	85/115	08.1996		RFC 52 LZDP6	A156		1,3	
	2.0 i 16V	3S-GE - FE [DOHC]	94-129/128-175	08.1996		RFC 58 LZ5	A101		1,1	F54-5
CARINA E (_T19_)	1.5 i 16V	5A-FE [DOHC]		08.1992	08.1996	RFC 52 LS5	A26	B24	1,1	F54-5
	1.6	4A-FE	73/99	12.1993	09.1997	RFC 52 LZDP	A152		0,8	
	1.6 16V	4A-FE	78/106	10.1995	09.1997	RFC 52 LZDP6	A156		1,3	
	1.6 GLI	4A-FE	79/107	04.1992	09.1997	RFC 52 LZDP6	A156		1,3	
	1.6	4A-FE	85/116	12.1993	09.1997	RFC 52 LZDP	A152		0,8	
	1.8	7A-FE	79/107	01.1995	09.1997	RFC 62 LSDP5	A507		1,1	
	2.0 i 16V	3S-FE [DOHC] Cat	93/126	12.1993	09.1997	RFC 58 LZ5	A101		1,1	F54-5
	2.0 GLI	3S-FE	98/133	04.1992	09.1997	RFC 58 LZ5	A101		1,1	F54-5
	2.0 GTi	3S-GE	116/158	04.1992	02.1994	RFC 52 LZDP	A152		0,8	
	2.0 i 16V	3S-GE [DOHC]	129/175	03.1994	09.1997	RFC 52 LZDP	A152		0,8	
CARINA EA (_T19_)	1.6	4A-FE	73/99	01.1995	09.1997	RFC 52 LZDP	A152		0,8	
	1.6	4A-FE	78/106	10.1995	09.1997	RFC 52 LZDP6	A156		1,3	
	1.6	4A-FE	79/107	01.1993	09.1997	RFC 52 LZDP6	A156		1,3	
	1.6 16V	4A-FE	85/116	12.1994	09.1997	RFC 52 LZDP6	A156		1,3	
	1.8 i	7A-FE	79/107	01.1995	09.1997	RFC 62 LSDP5	A507		1,1	
	2.0 i	3S-FE	93/126	12.1992	09.1997	RFC 58 LZ5	A101		1,1	F54-5
	2.0	3S-FE	98/133	01.1993	09.1997	RFC 58 LZ5	A101		1,1	F54-5
	2.0 GTi	3S-GE	116/158	04.1992	02.1994	RFC 52 LZDP	A152		0,8	
	2.0 GTi 16V	3S-GE [DOHC]	129/175	03.1994	09.1997	RFC 52 LZDP	A152		0,8	
CARINA E Sportswagon (_T19_)	1.6 i	4A-FE	73/99	02.1995	09.1997	RFC 52 LZDP	A152		0,8	
	1.6 GLI	4A-FE	79/107	01.1993	09.1997	RFC 52 LZDP6	A156		1,3	
	1.8 i	7A-FE	79/107	02.1995	09.1997	RFC 62 LSDP5	A507		1,1	
	2.0 i	3S-FE	98/133	05.1995	09.1997	RFC 58 LZ5	A101		1,1	F54-5
	2.0 GLI	3S-FE	98/133	01.1993	09.1997	RFC 58 LZ5	A101		1,1	F54-5
CARINA ED	1.8 i	4S-Fi		05.1988	09.1989	RFC 42 LS5	A83		1,1	F54-5
	2.0 i 16V	3S-FE [DOHC] Cat	94/128	08.1987	09.1989	RFC 58 LZ5	A101		1,1	F54-5
	2.0 i 16V	3S-GE [DOHC]	129/175	09.1989	10.1993	RFC 58 LZ5	A101		1,1	F54-5
CELICA Coupe (_A2_)	1.6 LT	2T	55/75	02.1976	03.1978	RC 52 LS	A9	B20	0,8	L65
	1.6 LT	2TJ	58/79	05.1973	03.1978	RC 52 LS	A9	B20	0,8	L65
	1.6 ST	2TB	63/86	05.1973	03.1978	RC 52 LS	A9	B20	0,8	L65
	1.6 GT	2T-G	79/107	12.1974	03.1978	RC 62 LS	A6	B17	0,8	L65
	2.0	18R	63/86	10.1975	07.1977	RC 62 LS	A6	B17	0,8	L65
CELICA (_A4_)	1.6 ST	2TB	63/86	08.1977	07.1981	RC 52 LS	A9	B20	0,8	L65
	1.6 ST	2T	66/90	02.1979	07.1981	RC 52 LS	A9	B20	0,8	L65
	2.0 XT	18R	65/88	01.1980	07.1981	RC 52 LS	A9	B20	0,8	L65
	2.0 XT	18R	66/90	02.1979	07.1981	RC 52 LS	A9	B20	0,8	L65
	2.0 GT	18R-G	90/122	08.1977	07.1981	RC 62 LS	A6	B17	0,8	L65
CELICA Coupe (_A4_)	1.6 LT	2TB	55/75	02.1979	07.1981	RC 52 LS	A9	B20	0,8	L65
	1.6 ST	4AL-2TB	63/86	08.1977	07.1981	RC 52 LS	A9	B20	0,8	L65
	1.6 ST	2T	66/90	02.1979	07.1981	RC 52 LS	A9	B20	0,8	L65
	1.6 GT	2T-G	80/109	04.1978	07.1981	RC 62 LS	A6	B17	0,8	L65
	1.6 GT	2T-G	81/110	04.1980	07.1981	RC 62 LS	A6	B17	0,8	L65
CELICA (_A6_)	2.0 XT	21 R - 21 RC	75-77/102-105	08.1981	08.1984	RC 62 LS	A6	B17	0,8	L65
	2.0 XT	21 R - 21 RC	75-77/102-105	09.1984	07.1985	RC 52 LS	A9	B20	0,8	L65
CELICA Coupe (_A6_)	1.6 i 16V	4A-GEL	91/124	12.1983	12.1985	RFC 58 LZ5	A101		1,1	F54-5
	2.0	21R-U	77/105	01.1982	12.1985	RC 62 LS	A6	B17	0,8	L65
	2.0	18R-G	88/120	01.1982	08.1984	RC 62 LS	A6	B17	0,8	L65
	2.0	18R-G	88/120	09.1984	12.1985	RC 52 LS	A9	B20	0,8	L65
	Supra 2.8	5M-GE	125/170	08.1981	12.1985	RC 62 LS	A6	B17	0,8	L65
CELICA (_T16_)	1.6	4A-L	63/86	04.1986	08.1989	RC 52 LS	A9	B20	0,8	L65
	1.6 GT	4A-GELC	85/116	08.1987	08.1989	RFN 58 LZDP5	A187		1,1	
	1.6 GT LPG	4A-GELC	85/116	08.1987	08.1989	RFN 62 LZDP5	A185		1,0	
	1.6 GT 16V	4A-GEL	91/124	09.1985	08.1989	RFC 58 LZ5	A101		1,1	F54-5

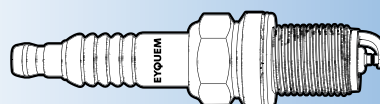

(1) Available until end of stock

- (a) 30 000 km
- (b) 60 000 km
- (c) Grey sticker on ignition coil
- (d) Green sticker on ignition coil

- (e) Hex 21 mm
- (f) Hex 16 mm
- (g) Recommended for cold weather



Box
10

Blister
4



F3-D1

TOYOTA

	2.0 GT	3S-GELC	103/140	09.1985	08.1989	RFN 58 LZDP5	A187		1,1	
	2.0 GT LPG	3S-GELC	103/140	09.1985	08.1989	RFN 62 LZDP5	A185		1,0	
	2.0 GT	3S-GEL	110/150	08.1985	08.1989	RFC 58 LZ5	A101		1,1	F54-5
CELICA Hatchback (_T16_)	1.6	4A-L	63/86	04.1986	08.1989	RC 52 LS	A9	B20	0,8	L65
	1.6 GT 16V	4A-GEL	91/124	04.1986	08.1989	RFC 58 LZ5	A101		1,1	F54-5
	2.0 GT	3S-GEL	110/150	01.1987	08.1989	RFC 58 LZ5	A101		1,1	F54-5
CELICA Coupe (_T16_)	2.0 Turbo 4WD	3S-GTE	136/185	03.1988	08.1989	RFN 58 LZDP5	A187		1,1	
	2.0 Turbo 4WD LPG	3S-GTE	136/185	03.1988	08.1989	RFN 62 LZDP5	A185		1,0	
CELICA Décapotable (_T16_)	2.0 GT	3S-GELC	103/140	08.1985	08.1989	RFN 58 LZDP5	A187		1,1	
	2.0 GT LPG	3S-GELC	103/140	08.1985	08.1989	RFN 62 LZDP5	A185		1,0	
	2.0 GT	3S-GEL	110/150	10.1986	08.1989	RFC 58 LZ5	A101		1,1	F54-5
CELICA Coupe (_T18_)	1.6	4A-FE	77/105	10.1989	11.1993	RFC 42 LS	A25		0,8	F54
	2.0 GTi	3S-GE	115/156	10.1989	11.1993	RFC 52 LZDP	A152		0,8	
	2.0 Turbo 4WD	3S-GTE	150/204	10.1989	11.1993	RFC 52 LZDP	A152		0,8	
	2.0 Turbo 4WD	3S-GTE	153/208	10.1989	11.1993	RFC 52 LZDP	A152		0,8	
CELICA Décapotable (_T18_)	2.0 GTi	3S-GE	115/156	10.1989	11.1993	RFC 52 LZDP	A152		0,8	
CELICA Coupe (_T20_)	1.8 i 16V	7A-FE	85/116	11.1993	11.1999	RFC 58 LS	A18		0,8	F54
	2.0 i 16V	3S-GE	125/170	04.1996	11.1999	RFC 52 LZDP	A152		0,8	
	2.0 i 16V	3S-GE	129/175	11.1993	11.1999	RFC 52 LZDP	A152		0,8	
	2.0 i Turbo 4WD	3S-GTE	178/242	02.1994	11.1999	RFC 52 LZDP	A152		0,8	
CELICA Décapotable (_T20_)	2.0 i 16V	3S-GE	125/170	11.1993	08.1999	RFC 52 LZDP	A152		0,8	
CELICA Coupe (_T23_)	1.8 16V VT-i	1ZZ-FE	105/143	11.1999	07.2005	RFC 58 LZ5	A101		1,1	F54-5
	1.8 16V TS	2ZZ-GE	141/192	08.1999	09.2005	RFC 62 LSDP5	A507		1,1	
CELICA LIFTBACK	1.6 i 16V Coupé, Liftback	4A-FE [DOHC] Cat	72-77/98-105	10.1989	06.1991	RFC 52 LS	A3	B16	1,0	F54
	1.6 GT	4A-GELC	85/115	08.1987	08.1989	RFN 58 LZDP5	A187		1,1	
	2.0 GT	3S-GELC	103/140	09.1985	08.1989	RFN 58 LZDP5	A187		1,1	
	2.0 GT, Liftback	3S-GELC	103/140	09.1985	08.1989	RFC 52 LZDP5	A149		1,1	
	2.0 GT, ST, XT, Liftback	18R	65/88	09.1979	12.1986	RC 62 LS	A6	B17	0,8	L65
	2.0 Liftback	18RG	87/118	08.1977	08.1984	RC 62 LS	A6	B17	0,8	L65
CELICA SUPRA	2.0 i	3Y-E	71/97	06.1996		RC 52 LS5	A36	B38	1,1	L65-5
CELSIOR	4.0 i V8 32V	1UZ-FE		10.1989	10.1994	RFC 52 LZDP5	A149		1,1	
CHASER / CRESTA	1.8 i	4S-Fi		08.1988	09.1990	RFC 42 LS5	A83		1,1	F54-5
	1.8 i 16V	4S-FE [DOHC] Cat	85/115	08.1990	09.1996	RFC 58 LZ5	A101		1,1	F54-5
	2.0 i 24V	1G-FE [DOHC]		08.1988	09.1996	RFC 52 LS5	A26	B24	1,1	F54-5
	2.0 i 24V	1G-GE [DOHC]	110/150	08.1988	11.1992	RFC 58 LS5	A38	B48	1,1	F54-5
	2.5 i 24V Turbo	1JZ-GTE [DOHC] Cat	207/281	08.1990	09.1996	RFC 52 LZDP5	A149		1,1	
	3.0 i 24V	7M-GE [DOHC]	150/204	08.1989	11.1992	RFC 52 LS5	A26	B24	1,1	F54-5
	3.0 i 24V	2JZ-GE Cat	156-163/212-222	11.1992	09.1996	RFC 58 LZ5	A101		1,1	F54-5
COASTER	1.5 i 16V	5E-FE [DOHC] Cat	74/101	08.1997		RFC 58 LZ5	A101		1,1	F54-5
	2.0	5R		01.1974	12.1986	C 62 LS	A4	B5	0,8	L65
	2.4	22 R		08.1979	01.1993	RC 52 LS	A9	B20	0,8	L65
	2.7	3RZ-F [DOHC]		09.1993	07.1999	RFC 58 LZ	A50		0,8	F54
	2.7 i	3RZ-F [DOHC]		07.1999		RFC 52 LS	A3	B16	0,8	F54
		B		01.1974	12.1986	C 62 LS	A4	B5	0,8	L65
COROLLA (KE_)	1.2	3K-B-C-H	40/54	05.1970	12.1980	RC 52 LS	A9	B20	0,8	L65
	1.2	3K-B-C-H	43/58	10.1972	07.1979	RC 52 LS	A9	B20	0,8	L65
COROLLA (KE, TE)	1.2	3K-B-C-H	40/54	09.1976	01.1980	RC 52 LS	A9	B20	0,8	L65
	1.6	2T	54/73	09.1976	01.1980	RC 62 LS	A6	B17	0,8	L65
	1.6	2TB	62/84	09.1976	01.1980	RC 62 LS	A6	B17	0,8	L65
COROLLA Combi (TE72_)	1.2	3K-B-H	40/54	07.1975	07.1979	RC 52 LS	A9	B20	0,8	L65
COROLLA Coupe (KE_)	1.2	3K-B-C-H	40/54	07.1975	08.1979	RC 52 LS	A9	B20	0,8	L65
COROLLA Hatchback (_E7_)	1.3	4K	44/60	09.1979	01.1982	RC 52 LS	A9	B20	0,8	L65
	1.3	4K	48/65	02.1982	05.1983	RC 52 LS	A9	B20	0,8	L65
	1.6	2T	54/73	09.1979	05.1983	RC 52 LS	A9	B20	0,8	L65
	1.6	2T	55/75	09.1979	05.1983	RC 52 LS	A9	B20	0,8	L65
	1.6	2TB	63/86	09.1979	05.1983	RC 52 LS	A9	B20	0,8	L65
	1.6 GT	2T-G	81/110	05.1980	09.1983	RC 62 LS	A6	B17	0,8	L65
	1.8	3T-C	63/86	08.1982	09.1983	RC 52 LS5	A36	B38	1,1	L65-5

(f) Available until end of stock

(a) 30 000 km

(b) 60 000 km

(c) Grey sticker on ignition coil

(d) Green sticker on ignition coil

(e) Hex 21 mm

(f) Hex 16 mm

(g) Recommended for

cold weather



EYQUEM



Box
10

Blister
4



F3→1

TOYOTA										
COROLLA Saloon (_E7_)	1.3	4K	44/60	09.1979	06.1983	RC 52 LS	A9	B20	0,8	L65
	1.3	4K	48/65	02.1982	06.1983	RC 52 LS	A9	B20	0,8	L65
	1.6	2T	55/75	10.1982	09.1983	RC 52 LS	A9	B20	0,8	L65
COROLLA Station Wagon (_E7_)	1.3	4K-C	44/60	12.1979	01.1982	RC 52 LS	A9	B20	0,8	L65
	1.3	4K	48/65	02.1982	07.1987	RC 52 LS	A9	B20	0,8	L65
COROLLA Liftback (_E8_)	1.3	2A-L	51/69	06.1983	09.1984	RC 52 LS	A9	B20	0,8	L65
	1.3	2E-LC	55/75	01.1985	08.1987	RC 62 LS5	A24		1,1	L65-5
	1.6	4A-LC	54/73	08.1985	08.1987	RC 52 LS	A9	B20	0,8	L65
	1.6	4A-L	62/84	06.1983	07.1987	RC 52 LS	A9	B20	0,8	L65
	1.6	4A-L	63/86	07.1985	05.1988	RC 52 LS5	A36	B38	1,1	L65-5
COROLLA FX Compact (_E8B_)	1.3	2E-L	55/75	08.1985	08.1987	RC 62 LS5	A24		1,1	L65-5
	1.6 GT	4A-GEL	89/121	08.1985	08.1987	RFC 58 LZ5	A101		1,1	F54-5
COROLLA Hatchback (_E8_)	1.3	2A-L	51/69	06.1983	09.1984	RC 52 LS	A9	B20	0,8	L65
	1.3	2E-LC	55/75	10.1984	08.1987	RC 62 LS5	A24		1,1	L65-5
	1.6	4A-LC	53/72	08.1985	08.1987	RC 52 LS	A9	B20	0,8	L65
	1.6	4A-LC	54/73	12.1985	05.1988	RC 52 LS	A9	B20	0,8	L65
	1.6	4A-L	62/84	06.1983	07.1987	RC 52 LS	A9	B20	0,8	L65
COROLLA Coupe (_AE86_)	1.6 GT	4A-GE	91/124	03.1983	07.1987	RFC 58 LZ5	A101		1,1	F54-5
COROLLA Liftback (_E9_)	1.3	2E	60/81	07.1987	04.1992	RC 52 LS5	A36	B38	1,1	L65-5
	1.3 i	2E-E	55/75	08.1987	01.1990	RC 52 LS	A9	B20	0,8	L65
	1.3 i	2E	55/75	08.1987	04.1992	RC 52 LS5	A36	B38	1,1	L65-5
	1.6	4A-F	66/90	08.1987	04.1992	RFN 42 LZG5	A112		1,1	
	1.6	4A-F	70/95	08.1987	04.1992	RFN 42 LZG5	A112		1,1	
	1.6	4A-FE	77/105	08.1989	04.1992	RFC 52 LS	A3	B16	0,8	F54
	1.6 GTI	4A-GE	92/125	07.1987	08.1989	RFC 58 LZ5	A101		1,1	F54-5
	1.6 GTI	4A-GE	92/125	09.1989	06.1993	RFC 52 LZDP	A152		0,8	
COROLLA Compact (_E9_)	1.3	2E	55/75	08.1987	12.1989	RC 52 LS5	A36	B38	1,1	L65-5
	1.6	4A-F	66/90	08.1987	04.1992	RFN 42 LZG5	A112		1,1	
	1.6 i	4A-FE	77/105	08.1989	04.1992	RFC 52 LS	A3	B16	0,8	F54
	1.6 GTI	4A-GE	85/116	08.1987	12.1989	RFC 58 LZ5	A101		1,1	F54-5
	1.6 GTI	4A-GE	85/116	01.1990	04.1992	RFC 52 LZDP	A152		0,8	
COROLLA Hatchback (_E9_)	1.3 i	2E	55/75	07.1987	12.1992	RC 52 LS5	A36	B38	1,1	L65-5
	1.3 i	2E-E	55/75	01.1990	01.1992	RC 52 LS	A9	B20	0,8	L65
	1.3	2E	60/81	05.1987	04.1992	RC 52 LS	A9	B20	0,8	L65
	1.6	4A-F	66/90	08.1987	12.1989	RFN 42 LZG5	A112		1,1	
	1.6 i	4A-FE	77/105	11.1989	06.1993	RFC 52 LS	A3	B16	0,8	F54
	1.6 i 4WD	4A-FE	77/105	10.1987	08.1990	RFC 58 LZ	A50		0,8	F54
COROLLA Station Wagon (_E9_)	1.3	2E	55/75	12.1987	06.1992	RC 52 LS5	A36	B38	1,1	L65-5
	1.6	4A-F	66/90	02.1988	05.1992	RFN 42 LZG5	A112		1,1	
	1.6	4A-F	70/95	12.1987	04.1992	RFN 42 LZG5	A112		1,1	
	1.6 XLI	4A-FE	77/105	11.1989	06.1992	RFC 52 LS	A3	B16	0,8	F54
	1.6 4WD	4A-FE	77/105	04.1988	10.1995	RFC 52 LS	A3	B16	0,8	F54
COROLLA Station Wagon (_E10_)	1.3	2E	53/72	07.1992	05.1995	RC 62 LS	A6	B17	0,8	L65
	1.3 XLI	4E-FE	55/75	09.1995	04.1997	RFC 58 LZ	A50		0,8	F54
	1.3 XLI 16V	4E-FE	65/88	07.1992	09.1995	RFC 58 LZ	A50		0,8	F54
	1.6 Si	4A-FE	84/114	07.1992	04.1997	RFC 58 LZ	A50		0,8	F54
COROLLA (_E10_)	1.3 12V	2E	53/72	07.1992	04.1997	RC 62 LS	A6	B17	0,8	L65
	1.3 XLI	4E-FE	55/75	09.1995	04.1997	RFC 58 LZ	A50		0,8	F54
	1.3 XLI 16V	4E-FE	65/88	07.1992	09.1995	RFC 58 LZ	A50		0,8	F54
	1.6 Si	4A-FE	84/114	09.1995	04.1997	RFC 58 LZ	A50		0,8	F54
	1.6	4A-FE	85/115	05.1992	07.1995	RFC 58 LZ	A50		0,8	F54
COROLLA Compact (_E10_)	1.3 12V	2E	53/72	07.1992	05.1995	RC 62 LS	A6	B17	0,8	L65
	1.3 XLI	4E-FE	55/75	09.1995	04.1997	RFC 58 LZ	A50		0,8	F54

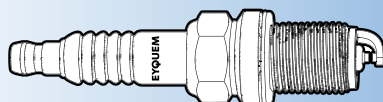

- (1) Available until end of stock
- (a) 30 000 km
- (b) 60 000 km
- (c) Grey sticker on ignition coil
- (d) Green sticker on ignition coil

- (e) Hex 21 mm
- (f) Hex 16 mm
- (g) Recommended for cold weather



Box
10

Blister
4



F3 →

TOYOTA

	1.3 XLI 16V	4E-FE	65/88	07.1992	09.1995	RFC 58 LZ	A50		0,8	F54
	1.6 Si	4A-FE	84/114	07.1992	04.1997	RFC 58 LZ	A50		0,8	F54
	1.8 GT	7A-FE	86/117	11.1992	05.1995	RFC 58 LZ	A50		0,8	F54
	1.8 GTi	7A-FE	81/110	11.1992	04.1995	RFC 58 LZ	A50		0,8	F54
COROLLA Compact (_E11_)	1.4	4ZZ-FE	71/97	02.2000	01.2002	RFC 58 LZ5	A101		1,1	F54-5
	1.4	4E-FE	63/86	05.1997	09.1999	RFC 42 LZ2E	A5		1,0	F54
	1.6 Automatic	4A-FE	79/107	04.1997	02.2000	RFC 58 LZ5	A101		1,1	F54-5
	1.6	4A-FE	81/110	04.1997	02.2000	RFC 58 LZ5	A101		1,1	F54-5
	1.6	3ZZ-FE	81/110	02.2000	01.2002	RFC 58 LZ5	A101		1,1	F54-5
COROLLA Liftback (_E10_)	1.3 12V	2E	53/72	07.1992	05.1995	RC 62 LS	A6	B17	0,8	L65
	1.3 XLI	4E-FE	65/88	07.1992	04.1997	RFC 58 LZ	A50		0,8	F54
	1.6	4A-FE	84/114	01.1993	04.1997	RFC 52 LS	A3	B16	0,8	F54
	1.8 GT	7A-FE	86/117	11.1992	05.1995	RFC 58 LZ	A50		0,8	F54
COROLLA (_E11_)	1.4	4ZZ-FE	71/97	02.2000	11.2001	RFC 58 LZ5	A101		1,1	F54-5
	1.4	4E-FE	63/86	04.1997	02.2000	RFC 42 LZ2E	A5		1,0	F54
	1.6 Automatic	4A-FE	79/107	04.1997	02.2000	RFC 58 LZ5	A101		1,1	F54-5
	1.6	3ZZ-FE	81/110	02.2000	11.2001	RFC 58 LZ5	A101		1,1	F54-5
COROLLA Liftback (_E11_)	1.4	4ZZ-FE	71/97	02.2000	01.2002	RFC 58 LZ5	A101		1,1	F54-5
	1.6 Automatic	4A-FE	79/107	04.1997	02.2000	RFC 58 LZ5	A101		1,1	F54-5
	1.6	4A-FE	81/110	04.1997	02.2000	RFC 58 LZ	A50		0,8	F54
	1.6	3ZZ-FE	81/110	02.2000	01.2002	RFC 58 LZ5	A101		1,1	F54-5
COROLLA Station Wagon (_E11_)	1.4	4E-FE	63/86	04.1997	02.2000	RFC 42 LZ2E	A5		1,0	F54
	1.4 16V	4ZZ-FE	71/97	02.2000	10.2001	RFC 58 LZ5	A101		1,1	F54-5
	1.6 Automatic	4A-FE	79/107	04.1997	02.2000	RFC 58 LZ5	A101		1,1	F54-5
	1.6	4A-FE	81/110	04.1997	02.2000	RFC 58 LZ5	A101		1,1	F54-5
	1.6 16V	3ZZ-FE	81/110	02.2000	10.2001	RFC 58 LZ5	A101		1,1	F54-5
	1.8	7A-FE	81/110	04.1997	10.2001	RFC 58 LZ	A50		0,8	F54
COROLLA (_E12_)	1.4 WVT-i	4ZZ-FE	71/97	01.2002	12.2006	RFC 58 LZ5	A101		1,1	F54-5
	1.6 WVT-i	3ZZ-FE	81/110	01.2002	12.2006	RFC 58 LZ5	A101		1,1	F54-5
	1.8 WTL-i TS	2ZZ-GE	141/192	01.2002	02.2007	RFN 62 LZDP5	A185		1,0	
	1.8 WTL-i TS	2ZZ-GE	165/224	02.2005	02.2007	RFN 62 LZDP5	A185		1,0	
COROLLA A (_E12_)	1.4 WVT-i	4ZZ-FE	71/97	08.2002	07.2007	RFC 58 LZ5	A101		1,1	F54-5
	1.6 WVT-i	3ZZ-FE	81/110	10.2001	07.2007	RFC 58 LZ5	A101		1,1	F54-5
COROLLA A NEW (_E18_,_ZRE17_)	1.3	1NR-FE	73/99	06.2013		RWN 42 HSI PW	A544		1,0	
	NEW 1.6	1ZR-FAE	97/132	06.2013		RWN 42 HSI PW	A544		1,0	
COROLLA Station Wagon (_E12_)	1.4 WVT-i	4ZZ-FE	71/97	01.2002	02.2007	RFC 58 LZ5	A101		1,1	F54-5
	1.6 WVT-i	3ZZ-FE	81/110	01.2002	08.2007	RFC 58 LZ5	A101		1,1	F54-5
COROLLA Verso (_E12_)	1.6 WVT-i	3ZZ-FE	81/110	01.2002	05.2004	RFC 58 LZ5	A101		1,1	F54-5
	1.8 WVT-i	1ZZ-FE	99/135	01.2002	05.2004	RFC 58 LZ5	A101		1,1	F54-5
COROLLA Verso (ZER, ZZE12_,R1)	1.6	3ZZ-FE	81/110	04.2004	03.2009	RFC 58 LZ5	A101		1,1	F54-5
	1.8	1ZZ-FE	95/129	04.2004	03.2009	RFC 58 LZ5	A101		1,1	F54-5
CORONA	1.5 i 16V	5A-FE [DOHC]		12.1987	02.1992	RFC 52 LS5	A26	B24	1,1	F54-5
	1.6	2T	55/75	01.1982	12.1984	RC 52 LS	A9	B20	0,8	L65
	1.6 i 16V	4A-GELU		01.1985	12.1989	RFC 58 LS5	A38	B48	1,1	F54-5
	1.6 i 16V	4A-FE [DOHC] Cat	77/105	08.1988	06.1991	RFC 52 LS5	A26	B24	1,1	F54-5
	1.6 i 16V	4A-FE [DOHC] Cat	77/105	06.1991	01.1996	RFC 58 LZ5	A101		1,1	F54-5
	1.6 i 16V	4A-FE [DOHC] Cat	77/105	01.1996		RFC 58 LZ5	A101		1,1	F54-5
	1.7	6R		01.1974	11.1987	RC 62 LS	A6	B17	0,8	L65
	1.8	2S - 2Y	57/78	08.1985		C 52 LS	A1	B1	0,8	L65
	1.8	16R				RC 62 LS	A6	B17	0,8	L65
	1.8 GL	13TU		09.1978	12.1981	C 62 LS3X	A13	B15	0,8	L65
	1.8 i	1S-L	64/87	10.1983	11.1987	RC 52 LS	A9	B20	0,8	L65
	1.8 i	1S-EL	89/121	08.1985	11.1987	RC 62 LS	A6	B17	0,8	L65
	1.8 i	4S-Fi		05.1988	11.1989	RFC 42 LS5	A83		1,1	F54-5
	1.8 i	4S-Fi		09.1989	10.1993	RFC 42 LS5	A83		1,1	F54-5
	1.8 i 16V	7A-FE [DOHC] Cat	85/115	01.1996		RFC 52 LZDP6	A156		1,3	
	1.8 i GLi	1S-EL	84/114	08.1985	11.1987	RC 52 LS	A9	B20	0,8	L65

(f) Available until end of stock

(a) 30 000 km

(b) 60 000 km

(c) Grey sticker on ignition coil

(d) Green sticker on ignition coil

(e) Hex 21 mm

(f) Hex 16 mm

(g) Recommended for cold weather



EYQUEM

217



Box
10

Blister
4



TOYOTA										
	2.0	21R	77/105	01.1976	12.1983	RC 62 LS	A6	B17	0,8	L65
	2.0	3S-GELU		01.1983		RFC 52 LS5	A26	B24	1,1	F54-5
	2.0 16V	3SF [DOHC]		12.1987	01.1992	RFC 52 LS5	A26	B24	1,1	F54-5
	2.0 i	1G-E	80/109	08.1985	11.1987	RC 62 LS	A6	B17	0,8	L65
	2.0 i 16V	3S-GE [DOHC]	129/175	12.1985	02.1992	RFC 58 LZ5	A101		1,1	F54-5
	2.0 i 16V	3S-FE [DOHC] Cat	94/128	12.1987	01.1992	RFC 52 LS5	A26	B24	1,1	F54-5
	2.0 i 16V	3S-GE - FE [DOHC]	94-129/128-175	09.1989	10.1993	RFC 58 LZ5	A101		1,1	F54-5
	2.0 i 16V	3S-FE [DOHC] Cat	94/128	02.1992	01.1996	RFC 58 LZ5	A101		1,1	F54-5
	2.0 i 16V	3S-FE [DOHC] Cat	94/128	01.1996		RFC 58 LZ5	A101		1,1	F54-5
	2.0 i GLi	2S-EL	89/121	08.1985	11.1987	RC 52 LS	A9	B20	0,8	L65
	2.3	2M				RC 52 LS	A9	B20	0,8	L65
	2.4 i	22 REC	81/110	08.1984	12.1986	RC 52 LS	A9	B20	0,8	L65
	2.6	4M			12.1983	RC 52 LS	A9	B20	0,8	L65
CORONA (RT1)	2.0	18R	65/88	01.1976	05.1979	RC 52 LS	A9	B20	0,8	L65
CORONA (_T1_)	1.8	3T	63/86	10.1979	01.1981	RC 62 LS	A6	B17	0,8	L65
CORONA (_T13_)	1.8	3T	63/86	06.1979	07.1981	RC 62 LS	A6	B17	0,8	L65
	1.8	3T	63/86	01.1982	11.1987	RC 52 LS	A9	B20	0,8	L65
CORONA Break (_RT118_)	2.0	18R	65/88	01.1976	05.1979	RC 52 LS	A9	B20	0,8	L65
CRESSIDA	1.8	1S-U - 3T	63/86	01.1980		RC 62 LS	A6	B17	0,8	L65
	2.0	18R	65/88	12.1976	08.1979	RC 52 LS	A9	B20	0,8	L65
	2.0	18R	65/88	09.1979	07.1981	RC 62 LS	A6	B17	0,8	L65
	2.0	21R	75-77/102-105	09.1980	08.1984	RC 62 LS	A6	B17	0,8	L65
	2.0	21R	75-77/102-105	09.1984	08.1988	RC 52 LS	A9	B20	0,8	L65
	2.0	21 RC	77/105	09.1980	08.1983	RC 62 LS	A6	B17	0,8	L65
	2.0 i	1G-E	80-90-92/ 109-122-125	08.1982	08.1988	RC 62 LS	A6	B17	0,8	L65
	2.0 i 24V	1G-GE [DOHC]	110/150	08.1984	08.1986	RFC 58 LS5	A38	B48	1,1	F54-5
	2.0 i 24V	1G-FE [DOHC]	99/135	08.1988		RFC 52 LS5	A26	B24	1,1	F54-5
	2.4	22 R	73-75/99-102	02.1985		RC 52 LS	A9	B20	0,8	L65
	2.6	4M		12.1976	07.1982	RC 62 LS	A6	B17	0,8	L65
	2.8 i	5M-GEU		01.1980	07.1984	RC 62 LS	A6	B17	0,8	L65
	2.8 i	5M-GE [DOHC]	125/170	08.1984	08.1987	RC 62 LS	A6	B17	0,8	L65
	2.8 i	5M-E	92-95/125-129	08.1984		RC 52 LS	A9	B20	0,8	L65
CROWN	2.0	5R	59/80	01.1971	08.1978	RC 52 LS	A9	B20	0,8	L65
	2.0	5M	81/110	09.1978		RC 52 LS	A9	B20	0,8	L65
	2.0	3Y	60-63/82-86	11.1983	09.1987	C 52 LS	A1	B1	1,0	L65
	2.0 6Cyl	M		10.1974	08.1979	RC 52 LS	A9	B20	0,8	L65
	2.0 i 24V	1G-GEU [DOHC]		01.1985		RFC 52 LS5	A26	B24	1,1	F54-5
	2.0 i 24V	1G-GZEU [DOHC]		01.1985		RFC 58 LS5	A38	B48	1,1	F54-5
	2.0 i 24V	1G-GE [DOHC]	110/150	09.1988	10.1991	RFC 58 LS5	A38	B48	1,1	F54-5
	2.0 i 24V	1G-FE [DOHC]	118/160	09.1988		RFC 58 LZ5	A101		1,1	F54-5
	2.2	4Y	60-63/82-86	11.1983		C 52 LS	A1	B1	1,0	L65
	2.3	2M			12.1983	RC 62 LS	A6	B17	0,8	L65
	2.5 i 24V Turbo	1JZ-GTE [DOHC] Cat	207/281	09.1999		RFC 52 LZDP5	A149		1,1	
	2.6	4M	100/136	09.1979	08.1980	RC 62 LS	A6	B17	0,8	L65
	2.8 i	5M-E	107/145	09.1979	09.1985	RC 62 LS	A6	B17	0,8	L65
	2.8 i	5M-GE [DOHC]	125-129/170-175	08.1983	08.1987	RC 62 LS	A6	B17	0,8	L65
	3.0 i	6M-GE [DOHC]	140/190	10.1984	08.1987	RC 62 LS	A6	B17	0,8	L65
	3.0 i 24V	7M-GE [DOHC]	140/190	10.1987		RFC 52 LS	A3	B16	1,0	F54
	3.0 i 24V	2JZ-GE Cat	156-163/212-222	10.1991	08.1995	RFC 58 LZ5	A101		1,1	F54-5
	4.0 i V8 32V	1UZ-FE		08.1989		RFC 52 LZDP5	A149		1,1	
	4.3 Royal Saloon	3UZ-FE	206/280	09.2003		RFC 62 LSDP5	A507		1,1	
	4.3 Royal Saloon 4x4	3UZ-FE	206/280	09.2003		RFC 62 LSDP5	A507		1,1	
CURREN	1.8 i 16V	4S-FE [DOHC] Cat	92/125	10.1995	07.1998	RFC 58 LZ5	A101		1,1	F54-5
	2.0 i 16V	3S-GE - FE [DOHC]	94-129/128-175	01.1994	07.1998	RFC 58 LZ5	A101		1,1	F54-5
CYNOS	1.3 i 16V	4E-FE [DOHC] Cat	55/75	01.1991	07.1999	RFC 52 LS5	A26	B24	1,1	F54-5
	1.5 i 16V	5E-FE [DOHC] Cat	74/101	01.1991	08.1995	RFC 58 LZ5	A101		1,1	F54-5
	1.5 i 16V	5E-FHE [DOHC] Cat	81/110	08.1995	07.1999	RFC 58 LZ5	A101		1,1	F54-5
DELI BOY	1.5	5K		07.1989		RC 52 LS	A9	B20	0,8	L65
DUET	1.0 i 12V	EJ-DE Cat	40/54	09.1998		RFC 58 LZ2	A54		1,0	F54
	1.3 i 16V	K3-VE [DOHC] Cat		05.2000		RFC 58 LZ5	A101		1,1	F54-5
DYNA (TOYO-ACE)	100, 150 : 1.8	1Y - 2Y		01.1985		RC 52 LS	A9	B20	0,8	L65
	150, 200 : 2.0	3Y	65/88	08.1984	08.1986	RC 52 LS5	A36	B38	1,1	L65-5
	2.0	5R			12.1984	RC 62 LS	A6	B17	0,8	L65

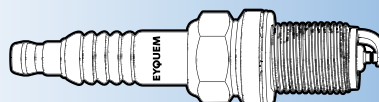

(1) Available until end of stock
 (a) 30 000 km
 (b) 60 000 km
 (c) Grey sticker on ignition coil
 (d) Green sticker on ignition coil

(e) Hex 21 mm
 (f) Hex 16 mm
 (g) Recommended for cold weather



Box
10

Blister
4



F3→1

TOYOTA

	2.0 i	3Y-E	71/97			RC 52 LS5	A36	B38	1,1	L65-5
	200 : 2.2	4Y	69/94	08.1986		RC 52 LS	A9	B20	0,8	L65
	200 : 2.4	22 R		08.1987		RC 52 LS	A9	B20	0,8	L65
	2000 : 2.0	5R		08.1977	12.1985	RC 62 LS	A6	B17	0,8	L65
	2500 : 2.5	2J				C 62 LS	A4	B5	0,8	L65
	3000 : 3.0	B				C 62 LS	A4	B5	0,8	L65
ESTIMA / LUCIDA / EMINA	2.4 i 16V	2TZ-FE	97/132	01.1992	01.2000	RFC 52 LS5	A26	B24	1,1	F54-5
	2.4 i 16V	2TZ-FZE [DOHC]	118/160	08.1994	01.2000	RFC 58 LZ5	A101		1,1	F54-5
FUN CARGO	1.3 i 16V	2NZ-FE	63/86	08.1999		RFC 52 LS5	A26	B24	1,1	F54-5
	1.5 i 16V	1NZ-FE [DOHC]	81/110	08.1999		RFC 52 LS5	A26	B24	1,1	F54-5
GAIA	2.0 i 16V	3S-FE [DOHC] Cat	94/128	05.1998		RFC 58 LZ5	A101		1,1	F54-5
GRANVIA	3.4 i 24V	5VZ-FE [DOHC]	133/181	08.1997		RFC 42 LZ2E	A5	B30	1,0	F54
HARRIER	2.2 i 16V	5S-FE [DOHC] Cat	100/136	04.1997		RFC 58 LS5	A38	B48	1,1	F54-5
HIACE	1.5	2R				RC 62 LS	A6	B17	0,8	L65
	1.6	12RJ		01.1972	08.1979	RC 52 LS	A9	B20	0,8	L65
	1.6	12RJ		09.1979	10.1982	RC 62 LS	A6	B17	0,8	L65
	1.6 Pick-up	12R		01.1982	07.1985	RC 52 LS5	A36	B38	1,1	L65-5
	1.8	2Y	58/79	03.1983	11.1989	RC 52 LS	A9	B20	0,8	L65
	1.8	2Y-U [OHV]	58/79	12.1982	08.1989	RC 52 LS5	A36	B38	1,1	L65-5
	1.8	2Y Cat		08.1988	05.1995	RC 52 LS	A9	B20	0,8	L65
	1.8 NF	16R				C 62 LS	A4	B5	0,8	L65
	2.0	18R		09.1981	10.1982	RC 52 LS	A9	B20	0,8	L65
	2.0	18R		10.1982		RC 62 LS	A6	B17	0,8	L65
	2.0	3Y	65/88	01.1985	01.1989	RC 52 LS	A9	B20	0,8	L65
	2.0 4x4	1RZ	74/101	08.1989		RC 52 LS	A9	B20	0,8	L65
	2.0 i	3Y-E	74/101	09.1989		RC 52 LS5	A36	B38	1,1	L65-5
	2.0 i MPV, Van, Radius	1RZ-E [SOHC]	81/110	08.1989		RC 52 LS5	A36	B38	1,1	L65-5
	2.2 4x4	4Y	69/94	08.1986	07.1987	RC 52 LS5	A36	B38	1,1	L65-5
	2.2 4x4	4Y	69/94	08.1987	08.1989	RC 52 LS	A9	B20	0,8	L65
	2.2 i 4x4, MPV	2RZ-E Cat	88/120	08.1989	07.1995	RC 52 LS5	A36	B38	1,1	L65-5
	2.7	3RZ-FE	106/144	11.2001	12.2006	RFC 52 LZDP6	A156		1,3	
	2.7, 4WD	3RZ-FE	105/143	04.1998	11.2001	RFC 52 LZDP6	A156		1,3	
	2.7, 4WD	3RZ-FE	105/143	04.1998	08.2006	RFC 52 LZDP6	A156		1,3	
HILUX / SURF	1.5	2R				RC 62 LS	A6	B17	0,8	L65
	1.6	12R				RC 62 LS	A6	B17	0,8	L65
	1.6	12RJ		01.1975	08.1979	RC 62 LS	A6	B17	0,8	L65
	1.6	1Y		01.1975		RC 62 LS	A6	B17	0,8	L65
	1.8	2Y-U [OHV]	58/79			RC 52 LS5	A36	B38	1,1	L65-5
	1.8	2Y-J [OHV]	58/79	11.1983	05.1989	RC 52 LS	A9	B20	0,8	L65
	1.8 Taro	2Y				RC 52 LS	A9	B20	0,8	L65
	2.0	18R - 3Y-C				RC 52 LS	A9	B20	0,8	L65
	2.0	3Y	65/88	09.1988	09.1997	RC 52 LS5	A36	B38	1,1	L65-5
	2.0 i	3Y-E	71/97	05.1989	09.1997	RC 52 LS5	A36	B38	1,1	L65-5
	2.2	4Y	69/94			RC 52 LS	A9	B20	0,8	L65
	2.4 i	22 RE Cat				RC 52 LS	A9	B20	0,8	L65
	2.4 i 4WD	2RZ-FE	103/140	08.1997		RFC 58 LZ	A50		0,8	F54
	3.0 iV6	3VZ-E Cat	105/143	08.1990	12.1995	RFC 52 LS	A3	B16	0,8	F54
	3.4 i 24V	5VZ-FE [DOHC]	111-137/150-185	12.1995		RFC 42 LZ2E	A5	B30	1,0	F54
HILUX VI Pick-up (N1)	2.4 i 4WD	2RZ-FE	103/140	08.1997	10.2005	RFC 58 LZ	A50		0,8	F54
IPSUM	2.0 i 16V	3S-FE [DOHC] Cat	94/128	05.1996		RFC 58 LZ5	A101		1,1	F54-5
IQ (_J1_) NEW	1.33	1NR-FE	72/98	01.2009		RWN 42 HSIPW	A544		1,0	
LAND CRUISER (J7)	2.4	22R	81/110	11.1984	05.1993	RC 52 LS	A9	B20	0,8	L65
	2.4 i	22 RE Cat	84/114	12.1988	12.1996	RC 52 LS	A9	B20	0,8	L65
LAND CRUISER 80 (_J8_)	4.0	3F-E	115/156	01.1990	08.1992	RC 52 LS5	A36	B38	1,1	L65-5
	4.5 24V	1FZ-FE	151/205	08.1992	08.1997	RFC 58 LZ	A50		0,8	F54
	4.5 24V LPG	1FZ-FE	151/205	08.1992	08.1997	RFC 52 LZDP	A152		0,7	
LAND CRUISER 90 (_J9_)	2.7 i	3RZ-F [DOHC]		05.1996		RFC 52 LS	A3	B16	0,8	F54
	3.4 i 24V	5VZ-FE [DOHC]	132/180	05.1996		RFC 42 LZ2E	A5	B30	1,0	F54
LAND CRUISER 100 (_J1_)	4.7	2UZ-FE	173/235	01.1998	08.2007	RFN 62 LZDP5	A185		1,0	
	4.7	2UZ-FE	175/238	02.2002	08.2007	RFN 62 LZDP5	A185		1,0	
LAND CRUISER PRADO	4.0	3F	107-115/146-156	08.1987	08.1992	RC 32 LS	A49	B19	0,8	L3
	4.0 i	3F-E [OHC]	114-115/155-156	01.1990	08.1992	RC 52 LS5	A36	B38	1,1	L65-5
	4.2	2F	89/121	08.1980	08.1987	RC 32 LS	A49	B19	0,8	L3
	4.5 i 24V	1FZ-FE [DOHC] Cat	151-158/205-215	01.1992	04.1996	RFC 58 LZ	A50		0,8	F54

(1) Available until end of stock

(a) 30 000 km

(b) 60 000 km

(c) Grey sticker on ignition coil

(d) Green sticker on ignition coil

(e) Hex 21 mm

(f) Hex 16 mm

(g) Recommended for cold weather

(g) Recommended for cold weather



EYQUEM



Box
10

Blister
4



F3-1

TOYOTA										
LAND CRUISER	NEW 4.0	1GR-FE	183/249	01.2003	03.2010	RFN 58 HZ5	A534		1.15	
PRADO	(_J12_)									
LITEACE / NOAH	1.3	4K-J			08.1990	RC 52 LS	A9	B20	0,8	L65
	1.3	4K	48/65			RC 52 LS	A9	B20	0,8	L65
	1.5	5K Cat		10.1985	01.1992	RC 32 LS	A49	B19	0,75	L3
	1.5	5K Cat		01.1992	01.1995	RC 52 LS	A9	B20	0,8	L65
	1.6	1Y				RC 52 LS	A9	B20	0,8	L65
	1.8	2Y	58/79	10.1986		RC 52 LS	A9	B20	0,8	L65
	1.8	2Y-C				RC 52 LS	A9	B20	0,8	L65
	1.8, Noah	2Y-U [OHV]	58/79	10.1982		RC 52 LS5	A36	B38	1,1	L65-5
	1.8 i	7K		10.1996		RC 52 LS	A9	B20	0,8	L65
	2.0	3Y	65/88	01.1993		RC 52 LS5	A36	B38	1,1	L65-5
	2.0 i 16V, Noah	3S-FE [DOHC] Cat	94/128	10.1996		RFC 58 LZ5	A101		1,1	F54-5
MARK II	1.8	2Y-J [OHV]	58/79	12.1988	02.1993	RC 52 LS	A9	B20	0,8	L65
	1.8 i	4S-Fi		08.1988	02.1990	RFC 42 LS5	A83		1,1	F54-5
	1.8 i 16V	4S-FE [DOHC] Cat	89/121	08.1990	09.1996	RFC 58 LZ5	A101		1,1	F54-5
	2.0 i	3Y-E	71/97	02.1993	04.1997	RC 52 LS5	A36	B38	1,1	L65-5
	2.0 i 24V	1G-FE [DOHC]		08.1988	04.1997	RFC 52 LS5	A26	B24	1,1	F54-5
	2.0 i 24V	1G-GE [DOHC]	110/150	08.1988	11.1992	RFC 58 LS5	A38	B48	1,1	F54-5
	2.2 i 16V	5S-FE [DOHC] Cat	104/141	09.1996		RFC 58 LS5	A38	B48	1,1	F54-5
	2.5 i 24V Turbo	1JZ-GTE [DOHC] Cat	207/281	08.1990	09.1996	RFC 52 LZDP5	A149		1,1	
	3.0 i 24V	7M-GE [DOHC]	150/204	08.1989	11.1992	RFC 52 LS5	A26	B24	1,1	F54-5
	3.0 i 24V	2JZ-GE Cat	156-163/212-222	11.1992	09.1996	RFC 58 LZ5	A101		1,1	F54-5
MARK II WAGON - QUALIS	2.2 i 16V	5S-FE [DOHC] Cat	100/136	04.1997		RFC 58 LS5	A38	B48	1,1	F54-5
MASTER ACE SURF	1.8	2Y-U [OHV]	58/79	11.1982	01.1992	RC 52 LS5	A36	B38	1,1	L65-5
MODELL F (CR2_, YR2_)	1.8	2Y Cat	58/79	11.1982	08.1984	RC 52 LS	A9	B20	0,8	L65
	1.8 4WD	2Y Cat	58/79	11.1982	07.1986	RC 52 LS	A9	B20	0,8	L65
	2.0 Super	3Y-3YC	65/88	08.1984	07.1988	RC 52 LS	A9	B20	0,8	L65
	2.0	3Y	66/90	08.1988	01.1990	RC 52 LS	A9	B20	0,8	L65
	2.2 i 4x4	4EYC Cat	72/98	01.1986	01.1990	RC 52 LS5	A36	B38	1,1	L65-5
MR 2	1500 : 1.5 i 16V S	3A-LU		06.1984	10.1989	RC 32 LS5	A110		1,1	
	1.6 i 16V	4A-GE [DOHC] Cat	91/124	06.1984	10.1989	RFC 58 LS5	A38	B48	1,1	F54-5
	2.0 i 16V	3S-GE [DOHC]	118/160	12.1989	10.1999	RFC 58 LZ5	A101		1,1	F54-5
	2.0 i 16V	3S-FE [DOHC] Cat	89/121	12.1989	08.1992	RFC 58 LZ5	A101		1,1	F54-5
	2.2 i 16V	5S-FE [DOHC] Cat	96-100/130-135			RFC 58 LS5	A38	B48	1,1	F54-5
MR 2 I (AW1_)	1.6 16V	4A-GELC	85/115	11.1984	06.1990	RFN 58 LZDP5	A187		1,1	
	1.6 16V LPG	4A-GELC	85/115	11.1984	06.1990	RFN 62 LZDP5	A185		1,0	
	1.6 i 16V GT	4A-GEL	91/124	11.1984	12.1989	RFC 58 LZ5	A101		1,1	F54-5
MR 2 II (SW2_)	2.0 i 16V	3S-GE [DOHC] Cat	115/156	01.1990	09.1999	RFC 52 LZDP	A152		0,8	
	2.0 i 16V	3S-GE [DOHC] Cat	125/170	12.1989	05.1996	RFC 52 LZDP	A152		0,8	
	2.0 i 16V	3S-GE [DOHC] Cat	125/170	06.1996	11.1999	RFC 58 LZ	A50		0,8	F54
	2.0 16V	3S-GE	129/175	12.1989	05.1996	RFC 52 LZDP	A152		0,8	
	2.0 16V	3S-GE	129/175	06.1996	05.2000	RFC 58 LZ	A50		0,8	F54
MR III (ZZW3_)	1.8 16V VT-i	1ZZ-FE	103/140	04.2000	06.2007	RFC 58 LZ5	A101		1,1	F54-5
NADIA	2.0 i 16V	3S-FE [DOHC] Cat	94/128	08.1998		RFC 58 LZ5	A101		1,1	F54-5
OPA	1.8 i 16V	1ZZ-FE [DOHC] Cat	91/124	01.2001		RFC 52 LS5	A26	B24	1,1	F54-5
PASEO	1.5 i 16V	5E-FE [DOHC]	66-74/90-100	10.1995	12.1997	RFC 58 LZ	A50		0,8	F54
	1.5 i 16V	5E-FE [DOHC]	66-74/90-100	01.1998	06.1999	RFC 58 LZ5	A101		1,1	F54-5
PICNIC (_XM1_)	2.0	3S-FE [DOHC] Cat	90/122	01.2001	12.2001	RFC 58 LZ5	A101		1,1	F54-5
	2.0 16V	3S-FE [DOHC] Cat	94/128	05.1996	12.2001	RFC 58 LZ5	A101		1,1	F54-5
	2.0 i 16V 4WD	3S-FE [DOHC] Cat	99/135	05.1996		RFC 58 LZ5	A101		1,1	F54-5
PLATZ	1.0 i 16V	1SZ-FE [DOHC]	50/68	08.1999		RFC 52 LS	A3	B16	0,8	F54
	1.3 i 16V	2NZ-FE	63/86	08.1999		RFC 52 LS5	A26	B24	1,1	F54-5
	1.5 i 16V	1NZ-FE [DOHC]	81/110	08.1999		RFC 52 LS5	A26	B24	1,1	F54-5
PREVIA (_R1_, _R2_)	2.4, 4WD	2TZ-FE	97/132	05.1990	08.2000	RFN 58 LZDP5	A187		1,1	
	2.4 LPG, 4WD	2TZ-FE	97/132	05.1990	08.2000	RFN 62 LZDP5	A185		1,0	
PREVIA (_R3_)	2.4, 4WD	2AZ-FE	115/156	08.2000	01.2006	RFN 62 LZDP5	A185		1,0	
PRIUS	2.4 i 16V	2TZ-FE	97/132	05.1990	08.2000	RFN 58 LZDP5	A187		1,1	
PRIUS (_W1_)	1.5	1NZ-FXE	53/72	05.2000	01.2004	FN 42 LZDPR5	A195		0,9	
PRIUS (_W2_)	1.5	1NZ-FXE	57/78	08.2003	03.2009	FN 42 LZDPR5	A195		0,9	
PRIUS (_W3_)	NEW 1.8 Hybrid	2ZR-FXE	73/99	04.2009		RWN 42 HSIPW	A544		1,0	
	NEW 1.8 Plug-in Hybrid	2ZR-FXE	73/99	01.2012		RWN 42 HSIPW	A544		1,0	
PRIUS PLUS (_W4_)	NEW 1.8 Hybrid	2ZR-FXE	73/99	05.2011		RWN 42 HSIPW	A544		1,0	

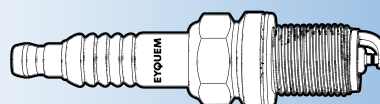

(1) Available until end of stock

- (a) 30 000 km
- (b) 60 000 km
- (c) Grey sticker on ignition coil
- (d) Green sticker on ignition coil

- (e) Hex 21 mm
- (f) Hex 16 mm
- (g) Recommended for cold weather



KW/HP



Box
10

Blister
4



F3-D1

TOYOTA

PROGRESS	3.0 i 24V	2JZ-GE Cat	156-163/212-222	05.1998		RFC 58 LZ5	A101	1,1	F54-5
RAUM	1.5 i 16V	5E-FE [DOHC] Cat	74/101	10.1995		RFC 58 LZ5	A101	1,1	F54-5
RAV4 I (_A1_)	2.0 4WD	3S-FE	94/129	06.1994	09.1997	RFC 58 LZ5	A101	1,1	F54-5
	2.0 4WD	3S-FE	94/129	10.1997	06.2000	RFN 58 LZDP5	A187	1,1	
RAV4 I Cabrio (_A1_)	2.0 4WD	3S-FE	94/129	12.1997	06.2000	RFN 58 LZDP5	A187	1,1	
RAV 4 II (_A2_)	1.8 i 16V	1ZZ-FE [DOHC] Cat	92/125	08.2000	11.2005	RFC 58 LZ5	A101	1,1	F54-5
RAV 4 III (_A3_)	2.0 4WD	1AZ-FE	112/152	03.2006		RFN 62 LZDP5	A185	1,0	
	NEW 2.0, 4WD	3ZR-FAE	116/158	12.2008		RWN 42 HSIPIW	A544	1,0	
RAV 4 IV (_A4_)	NEW 2.0 4WD	3ZR-FE	107/146	12.2012		RWN 42 HSIPIW	A544	1,0	
	NEW 2.0 4WD	3ZR-FAE	111/151	12.2012		RWN 42 HSIPIW	A544	1,0	
	NEW 2.0 4WD	3ZR-FAE	112/152	04.2015		RWN 42 HSIPIW	A544	1,0	
SCEPTER	2.2 i 16V	5S-FE [DOHC] Cat	100/136	11.1992	07.1996	RFC 58 LS5	A38	B48	1,1 F54-5
	3.0 i 24V	3VZ-FE [DOHC] Cat	138/188	11.1992	07.1996	RFC 52 LZDP5	A149		1,1
SERA	1.5 i 16V	5E-FHE [DOHC] Cat	81/110	03.1990	11.1995	RFC 58 LZ5	A101		1,1 F54-5
SOARER	2.0 i 24V	1G-GEU [DOHC]		01.1988	05.1991	RFC 52 LS5	A26	B24	1,1 F54-5
	2.0 i 24V	1G-FE [DOHC]		01.1989	05.1991	RFC 52 LS5	A26	B24	1,1 F54-5
	2.5 i 24V Turbo	1JZ-GTE [DOHC] Cat	207/281	05.1991		RFC 52 LZDP5	A149		1,1
	3.0 i 24V	2JZ-GE Cat	156-163/212-222	01.1994	09.1996	RFC 58 LZ5	A101		1,1 F54-5
	4.0 i V8 32V	1UZ-FE		05.1991		RFC 52 LZDP5	A149		1,1
SPARKY	1.3 i 16V	K3-VE [DOHC] Cat		10.2000		RFC 58 LZ5	A101		1,1 F54-5
SPRINTER	1.2	3K	39/53	05.1970	05.1978	RC 62 LS	A6	B17	0,8 L65
	1.3	2E		05.1987	06.1991	RC 52 LS5	A36	B38	1,1 L65-5
	1.3 i 16V	4E-FE [DOHC]	55/75	06.1991	05.1995	RFC 52 LS5	A26	B24	1,1 F54-5
	1.3 i 16V	4E-FE [DOHC] Cat	55/75	01.1994		RFC 52 LS5	A26	B24	1,1 F54-5
	1.5 i 16V	5A-FHE [DOHC] Cat	78/106	06.1986	05.1992	RFC 52 LS	A3	B16	0,8 F54
	1.5 i 16V	5A-FE [DOHC]		06.1991		RFC 52 LS5	A26	B24	1,1 F54-5
	1.5 i 16V	5E-FE [DOHC] Cat	74/101	06.1991		RFC 58 LZ5	A101		1,1 F54-5
	1.6	2T	55-63/75-86	05.1970	04.1979	RC 62 LS	A6	B17	0,8 L65
	1.6	2T-G	80/109	08.1974	04.1979	RC 72 LS	A32	B26	0,8 L87
	1.6 16V	4A-F [DOHC]	70/95	05.1988	08.1989	RFC 52 LS	A3	B16	0,8 F54
	1.6 i 16V	4A-GE [DOHC] Cat	91/124	05.1987	05.1992	RFC 58 LZ5	A101		1,1 F54-5
	1.6 i 16V	4A-FHE [DOHC]	81/110	02.1988	08.1995	RFC 52 LS	A3	B16	0,8 F54
	1.6 i 16V	4A-FE [DOHC] Cat	77/105	06.1989	06.1991	RFC 52 LS5	A26	B24	1,1 F54-5
	1.6 i 16V	4A-FE [DOHC] Cat	77/105	06.1991		RFC 58 LZ5	A101		1,1 F54-5
	1.8 i 16V	7A-FE [DOHC] Cat	85/115	08.1995		RFC 58 LZ5	A101		1,1 F54-5
STARLET	1.0	2K	33/45	02.1978	02.1984	RC 52 LS	A9	B20	0,8 L65
	1.0	1EL	40/54	10.1984	11.1989	RC 62 LS	A6	B17	1,0 L65
	1.2	3K-H	39/53	02.1978	09.1984	RC 52 LS	A9	B20	0,8 L65
	1.3	4K	36-48/49-65	08.1981	02.1984	RC 52 LS	A9	B20	0,8 L65
	1.3	2E Cat	53-55/72-75	10.1984	08.1987	RC 52 LS5	A36	B38	1,1 L65-5
	1.3	2E-LJ	55/75	10.1984	12.1989	RC 62 LS	A6	B17	1,0 L65
	1.3	2E-LC	55/75	10.1984	08.1987	RC 62 LS5	A24		1,1 L65-5
	1.3	1E - 2E		12.1989	12.1992	C 62 LS	A4	B5	0,8 L65
	1.3	2E		12.1989	12.1992	RC 52 LS5	A36	B38	1,1 L65-5
	1.3	1E		12.1989	12.1992	RC 62 LS	A6	B17	1,0 L65
	1.3	4E-FE	55/75	01.1996	10.1999	RFC 58 LZ	A50		0,8 F54
	1.3 i	2E-ELU		10.1984	12.1989	RC 52 LS5	A36	B38	1,1 L65-5
	1.3 i	2E-LU		01.1987	12.1989	RC 52 LS5	A36	B38	1,1 L65-5
	1.3 i 12V	2E-E Cat	55-60/75-82	12.1989	01.1996	RC 52 LS	A9	B20	0,8 L65
	1.3 i 16V	4E-F [DOHC]	55/75	12.1989	01.1996	RFC 52 LS5	A26	B24	1,1 F54-5
	1.3 i 16V	4E-FE [DOHC] Cat	55-62/75-84	01.1996	07.1999	RFC 52 LS5	A26	B24	1,1 F54-5
STOUT		GG - GR			12.1980	C 62 LS	A4	B5	0,8 L65
SUPRA	2.0 i 24V	1G-GEU [DOHC]		01.1986	05.1993	RFC 52 LS5	A26	B24	1,1 F54-5
	2.0 i 24V	1G-FE [DOHC]		01.1986	08.1992	RFC 52 LS5	A26	B24	1,1 F54-5
	2.5 i 24V Turbo	1JZ-GTE [DOHC] Cat	207/281	08.1990	05.1993	RFC 52 LZDP5	A149		1,1
	2.8 i GT	5M-GE [DOHC]	125/170	12.1981	09.1987	RC 62 LS	A6	B17	0,8 L65
	2.8 i Supra	5M-GE [DOHC]	125-129/170-175	12.1981	09.1987	RC 62 LS	A6	B17	0,8 L65
	2.8 i Supra	5M-E	103/140	08.1982	12.1985	RC 62 LS	A6	B17	0,8 L65
	3.0 i 24V	7M-GE [DOHC]	150-153-155/ 204-208-211	08.1988	04.1993	RFC 52 LS5	A26	B24	1,1 F54-5
	3.0 i 24V	2JZ-GE Cat	156-163/212-222	05.1993	09.1996	RFC 58 LZ5	A101		1,1 F54-5
SUPRA (_A7_)	3.0 24V	7M-GE	150/204	01.1986	08.1988	RFC 58 LZ	A50		0,8 F54
	3.0 Turbo	7M-GTE	173/235	09.1987	04.1993	RFC 52 LZDP	A152		0,8
	3.0 Turbo	7M-GTE	175/238	08.1988	05.1993	RFC 52 LZDP	A152		0,8
SUPRA (_A8_)	3.0 i Bi-Turbo	2JZ-GTE	243/330	05.1993	07.2002	RFC 62 LSDP5	A507		1,1

(f) Available until end of stock

(a) 30 000 km

(b) 60 000 km

(c) Grey sticker on ignition coil

(d) Green sticker on ignition coil

(e) Hex 21 mm

(f) Hex 16 mm

(g) Recommended for

cold weather

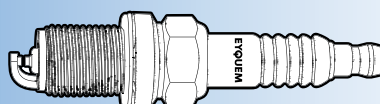

EYQUEM



Box 10
Blister 4



F3

TOYOTA										
TERCEL	1.3	2A	48-55/65-75	10.1982	08.1984	RC 52 LS	A9	B20	0,8	L65
	1.3	2E		05.1986	09.1990	RC 52 LS5	A36	B38	1,1	L65-5
	1.3 12V	2E		05.1986	09.1990	RC 62 LS	A6	B17	0,8	L65
	1.3 i 16V	4E-FE [DOHC]	55/75	09.1990	07.1999	RFC 52 LS5	A26	B24	1,1	F54-5
	1.5	3AC	50-52/68-71	10.1982	01.1988	RC 52 LS	A9	B20	0,8	L65
	1.5	3A-C	52/71	10.1982	08.1984	RC 52 LS	A9	B20	0,8	L65
	1.5	3A-C Cat	50/68	05.1986	01.1988	RC 52 LS5	A36	B38	1,1	L65-5
	1.5 Break, 4x4	3A-C Cat	52/71	10.1982	08.1987	RC 52 LS	A9	B20	0,8	L65
	1.5 Break, 4x4	3A-C Cat	52/71	09.1987	01.1988	RC 52 LS5	A36	B38	1,1	L65-5
	1.5 i	3E [SOHC]	58/79	05.1986	09.1990	RC 52 LS5	A36	B38	1,1	L65-5
	1.5 i	3E-LU				RC 62 LS5	A24		1,1	L65-5
	1.5 i 12V	3E-TE	85/115	09.1986	09.1990	RC 62 LS5	A24		1,1	L65-5
	1.5 i 16V	5E-FE [DOHC]	66/90	09.1990	07.1999	RFC 58 LZ5	A101		1,1	F54-5
	1.5 i 16V	5E-FHE [DOHC] Cat	81/110	09.1990	09.1994	RFC 58 LZ5	A101		1,1	F54-5
	1.6 i 16V	4A-FE [DOHC] Cat	76-77/103-105	09.1990	06.1991	RFC 52 LS	A3	B16	1,0	F54
TOWN ACE / NOAH	1.2	3K-J				C 52 LS	A1	B1	0,8	L65
	1.3	4K-J		08.1985	08.1992	RC 52 LS	A9	B20	0,8	L65
	1.5	5K		10.1996		RC 52 LS	A9	B20	0,8	L65
	1.5	5K		10.1986		RC 52 LS	A9	B20	0,8	L65
	1.6	2T	55/75			RC 52 LS	A9	B20	0,8	L65
	1.6	12RJ - 2TJ				C 62 LS	A4	B5	0,8	L65
	1.8	2Y		10.1986		RC 52 LS	A9	B20	0,8	L65
	1.8	13TU				C 62 LS	A4	B5	0,8	L65
	1.8, Noah	2Y-U [OHV]	58/79	11.1982	01.1992	RC 52 LS5	A36	B38	1,1	L65-5
	1.8 i	7K		10.1996	12.1998	RC 52 LS	A9	B20	0,8	L65
	2.0 i 16V, Noah	3S-FE [DOHC] Cat	94/128	10.1996		RFC 58 LZ5	A101		1,1	F54-5
TOYO-ACE / DYNA	1.6	12R				RC 62 LS	A6	B17	0,8	L65
	1.8	2Y Cat		08.1987	09.1993	RC 52 LS	A9	B20	0,8	L65
	2.0	3Y	65/88	05.1995		RC 52 LS5	A36	B38	1,1	L65-5
	2.0	5R				C 52 LS	A1	B1	0,8	L65
URBAN CRUISER (P1_)	1.33	1NR-FE	73/99	01.2009		RWN 42 HSIPW	A544		1,0	
	NEW 1.33	1NR-FE	74/101	04.2009		RWN 42 HSIPW	A544		1,0	
VERSO (_R2_)	NEW 1.6	1ZR-FAE	97/132	04.2009		RWN 42 HSIPW	A544		1,0	
	NEW 1.8	2ZR-FAE	108/147	04.2009		RWN 42 HSIPW	A544		1,0	
VERSO S (_P12_)	NEW 1.33	1NR-FE	73/99	11.2010	10.2016	RWN 42 HSIPW	A544		1,0	
VISTA / ARDEO	1.8 i	4S-Fi		08.1988	07.1990	RFC 42 LS5	A83		1,1	F54-5
	1.8 i 16V	4S-FE [DOHC] Cat	93/126	07.1990	06.1994	RFC 58 LZ5	A101		1,1	F54-5
	1.8 i 16V	1ZZ-FE [DOHC] Cat	91/124	07.1998		RFC 52 LS5	A26	B24	1,1	F54-5
	2.0 i 16V	3S-FE [DOHC] Cat	94/128	08.1986	06.1994	RFC 58 LZ5	A101		1,1	F54-5
	2.0 i 16V	3S-GE [DOHC]	129/175	08.1988	06.1992	RFC 58 LZ5	A101		1,1	F54-5
VITZ	1.0 i 16V	1SZ-FE [DOHC]	50/68	01.1999		RFC 52 LS	A3	B16	0,8	F54
	1.3 i 16V	2NZ-FE	63/86	08.1999		RFC 52 LS5	A26	B24	1,1	F54-5
	1.5 i 16V	1NZ-FE [DOHC]	81/110	10.2000		RFC 52 LS5	A26	B24	1,1	F54-5
WILL Vi	1.3 i 16V	2NZ-FE	63/86	01.2000		RFC 52 LS5	A26	B24	1,1	F54-5
WILL VS	1.8 i 16V	1ZZ-FE [DOHC] Cat	91/124	04.2001		RFC 52 LS5	A26	B24	1,1	F54-5
WINDOM	2.5 i V6 24V	4VZ-FE [DOHC] Cat	130/177	08.1993	08.1996	RFC 58 LS5	A38	B48	1,1	F54-5
	3.0 i 24V	3VZ-FE [DOHC] Cat	138/188	10.1991	08.1996	RFC 52 LZDP5	A149		1,1	
WISH	2.0 Zi	1AZ-FSE	114/155	04.2003		RFC 62 LSDP5	A507		1,1	
YARIS (_P1_)	1.0 16V	1SZ-FE	50/68	04.1999	12.2002	RFC 58 LZ5	A101		1,1	F54-5
	1.0 16V	1SZ-FE	48/65	03.2003	08.2005	RFC 58 LZ5	A101		1,1	F54-5
	1.3 16V	2NZ-FE	63/86	11.1999	10.2005	RFC 58 LZ5	A101		1,1	F54-5
	1.3 16V	2SZ-FE	64/87	08.1999	09.2005	RFC 58 LZ	A50		0,9	F54
	1.3 i 16V 85 VVTi, Linea Sol / Luna	2NZ-FE	63-66/86-90	11.1999		RFC 52 LS5	A26	B24	1,1	F54-5
	1.5	1NZ-FE	77/105	01.2003	11.2005	RFC 58 LZ5	A101		1,1	F54-5
	1.5	1NZ-FE	78/106	04.2001	09.2005	RFC 58 LZ	A50		0,8	F54
	1.5 i 16V 105 VVTi TS, Sport	1NZ-FE [DOHC]	81/110	03.2000		RFC 52 LS5	A26	B24	1,1	F54-5
	1.5	1NZ-FE	110/150	03.2000	07.2005	RFC 58 LZ	A50		0,8	F54
YARIS (_P2_)	1.3	2NZ-FE	62/84	11.2000	09.2005	RFC 58 LZ5	A101		1,1	F54-5
YARIS (_P9_)	NEW 1.0 VVT-i	1KR-FE	51/69	08.2005		RFN 58 HZ5	A534		1,15	
	1.33 VVT-i	2SZ-FE	64/87	08.2005		RFC 58 LZ	A50		0,8	F54
	NEW 1.33 VVT-i	1NR-FE	73/99	07.2010		RWN 42 HSIPW	A544		1,0	
	NEW 1.33 VVT-i	1NR-FE	74/100	11.2008		RWN 42 HSIPW	A544		1,0	
	NEW 1.8 VVT-i	2ZR-FE	98/133	01.2007		RWN 42 HSIPW	A544		1,0	
YARIS (_P13_)	NEW 1.3	1NR-FE	73/99	09.2011		RWN 42 HSIPW	A544		1,0	

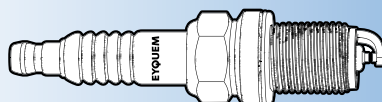

- (1) Available until end of stock
- (a) 30 000 km
- (b) 60 000 km
- (c) Grey sticker on ignition coil
- (d) Green sticker on ignition coil

- (e) Hex 21 mm
- (f) Hex 16 mm
- (g) Recommended for cold weather



Box
10

Blister
4



F3→1

TOYOTA

YARIS VERSO (_P2_) 1.3	2NZ-FE	62/84	11.2002	09.2005	RFC 58 LZ5	A101		1,1	F54-5
1.3	2NZ-FE	63/86	08.1999	10.2002	RFC 58 LZ5	A101		1,1	F54-5
1.5	1NZ-FE	77/105	05.2003	09.2005	RFC 58 LZ5	A101		1,1	F54-5
1.5	1NZ-FE	78/106	03.2000	09.2005	RFC 58 LZ	A50		0,8	F54
YARIS VERSO 105 VWTi, Linea Sol	1NZ-FE [DOHC]	81/110	03.2000		RFC 52 LS5	A26	B24	1,1	F54-5
85 VWTi, Linea Luna	2NZ-FE	63/86	11.1999		RFC 52 LS5	A26	B24	1,1	F54-5
4 RUNNER (N5_, N6_, N7_) 2.4 4WD	22REC	82/112	01.1989	07.1989	RC 52 LS	A9	B20	0,8	L65
4 RUNNER (_N1_) 3.0	3VZ-E	105/143	07.1990	11.1995	RFC 58 LZ	A50		0,8	F54

TRABANT

601 0.6 S	P65 - P66				C 62 S	A55		0,6	
1.1 1.1	VW				C 62 LS	A4	B5	0,7	L65
1.1 1.1	4V05,9 / 7,5GRF	30/41	05.1990	12.1991	C 62 LS	A4	B5	0,7	L65
1.1 Tramp	4V05,9 / 7,5GRF	30/41	05.1990	12.1991	C 62 LS	A4	B5	0,7	L65
1.1 Universal	4V05,9 / 7,5GRF	30/41	12.1990	12.1991	C 62 LS	A4	B5	0,7	L65

TRACER

TRACER 1.6 i	(5)		01.1988	12.1990	RC 32 LS5	A110		1,1	
1.8 i 16V	(8)		09.1990		RFC 42 LS	A25		0,8	F54
VILLAGER 3.0 i	VG30E	113/154	09.1992		RFC 52 LS5	A26	B24	1,1	F54-5

TRIUMPH

2500 2500 TC :					C 52 LS	A1	B1	0,7	L65
ACCLAIM 1.3				12.1984	RC 62 LS	A6	B17	0,7	L65
DOLOMITE 1300, 1500, 1850					C 52 LS	A1	B1	0,7	L65
2.0 Sprint					C 62 LJS	A19	B2	0,7	J65
SPITFIRE 1500 : 1.5					C 52 LS	A1	B1	0,7	L65
TR 7 2.0					C 52 LS	A1	B1	0,7	L65
TR 8 3.5					RC 22 LZ	A131		0,7	

TVR

280 2.8 iV6		110/150	03.1980		RC 72 LS	A32	B26	0,8	L87
350 3.5 iV8		145/197	03.1980		RC 62 LS	A6	B17	0,8	L65
390 SE 3.9 iV8		202/275	10.1984	12.1988	RC 72 LS	A32	B26	0,8	L87
400 SE 4.0 iV8		202/275	09.1988		RC 72 LS	A32	B26	0,8	L87
420 SEAC 4.2 iV8		219/298	09.1984	12.1988	RC 72 LS	A32	B26	0,8	L87
450 SEAC 4.5 iV8		234/318	09.1988		RC 72 LS	A32	B26	0,8	L87
CERBERA 4.2 iV8	APJ8	257/350	01.1994		RFC 52 LS3	A66		1,2	
CHIMAERA 4.0		206/280	01.1992		RC 62 LS	A6	B17	0,7	L65
4.2 V8		206/280	01.1992		RC 62 LS	A6	B17	0,7	L65
5.0 V8		250/340	01.1992		RC 72 LS	A32	B26	0,7	L87
CLIPPER 5.9					RC 32 LS	A49	B19	0,9	L3
GRIFFITH 4.2 V8		198/269	01.1990		RC 72 LS	A32	B26	0,7	L87
500 : 5.0 V8		250/340	01.1993		RC 72 LS	A32	B26	0,7	L87
ROADSTERS 2.8 iV6		105-110/143-150	10.1986		RC 72 LS	A32	B26	0,8	L87
S 2.8 V6		99/135	01.1987	12.1988	RC 72 LS	A32	B26	0,8	L87
2.9 iV6		110/150	01.1989		RFC 58 LS	A18		0,8	F54
2.9 iV6		125/170	01.1989		RC 52 LJS	A62	B27	0,8	J65
S2 2.9 iV6		125/170	10.1986		RC 72 LS	A32	B26	0,8	L87
S2C 2.9 iV6		125/170	10.1986		RC 72 LS	A32	B26	0,8	L87
TAIMAR 3.0 V6					RC 62 LS	A6	B17	0,8	L65
3.0 V6 Turbo					C 82 LS	A40	B6	0,8	L87
TASMIN 2.0	[OHC]	77/105	01.1981	12.1984	RKC 62 JS	A29		0,8	
2.8 iV6		110/150	01.1980	12.1985	RC 72 LS	A32	B26	0,8	L87
2.8 V6		99/135	01.1980	12.1985	RC 72 LS	A32	B26	0,8	L87
TUSCAN 3.5 iV8		145/197	01.1989		RC 62 LS	A6	B17	0,8	L65

VANDEN PLAS

1500 1500 : 1.5					C 62 LS	A4	B5	0,6	L65
-----------------	--	--	--	--	---------	----	----	-----	-----

VAUXHALL

AGILA 1.0 i	Z 10 XE Ecotec [DOHC]	43/58	07.2000		RFC 42 LZ2E	A5	B30	1,0	F54
ASTRA 1.2	12 ST [OHC]	40/54	01.1989	08.1991	RC 62 LS	A6	B17	0,7	L65
1.2 i	Z 12 XE Ecotec [DOHC]	55/75	07.2000		RFC 42 LZ2E	A5	B30	1,0	F54

(f) Available until end of stock

(a) 30 000 km

(b) 60 000 km

(c) Grey sticker on ignition coil

(d) Green sticker on ignition coil

(e) Hex 21 mm

(f) Hex 16 mm

(g) Recommended for cold weather



EYQUEM



Box
10

Blister
4



F3 → 1

VAUXHALL

	1.2 i 16V	X 12 XE [DOHC]	48/65	03.1998		RFC 42 LZ2E	A5	B30	1,0	F54
	1.2 S	12 S	44/60	09.1984	12.1988	RC 42 S	A69	B23	0,7	N43
	1.3 S, S Estate	13 S [OHC]	55/75	09.1984	08.1991	RC 62 LS	A6	B17	0,7	L65
	1.4	14 NV [OHC]	55/75	01.1990	08.1991	RC 62 LS	A6	B17	0,7	L65
	1.4	14 NV [OHC]	55/75	09.1991	02.1998	RFC 42 LZ2E (f)	A5	B30	1,0	F54
	1.4	14 NV [OHC]	55/75	09.1991	02.1998	RC 52 LS (e)	A9	B20	0,7	L65
	1.4 i	C 14 NZ [OHC]	44/60	09.1991		RFC 42 LZ2E (f)	A5	B30	1,0	F54
	1.4 i	C 14 SE [OHC]	60/82	09.1991		RFC 42 LZ2E (f)	A5	B30	1,0	F54
	1.4 i	C 14 NZ [OHC]	44/60	09.1991		RC 52 LS (e)	A9	B20	0,7	L65
	1.4 i	C 14 SE [OHC]	60/82	09.1991		RC 52 LS (e)	A9	B20	0,7	L65
	1.4 i	14 SE [OHC II]	60/82	03.1992	03.1996	RFC 42 LZ2E (f)	A5	B30	1,0	F54
	1.4 i	14 SE [OHC II]	60/82	03.1992	03.1996	RC 52 LS (e)	A9	B20	0,7	L65
	1.4 i 16V	X 14 XE [DOHC]	66/90	04.1996		RFC 42 LZ2E	A5	B30	1,0	F54
	1.6 i	E 16 NZ	55/75	01.1991	08.1993	RC 62 LS5	A24		1,1	L65-5
	1.6 i	X 16 SZ [OHC]	52/71	09.1991		RFC 42 LZ2E (f)	A5	B30	1,0	F54
	1.6 i	C 16 NZ - E 16 NZ - X 16 SZR [OHC]	55/75	09.1991		RFC 42 LZ2E	A5	B30	1,0	F54
	1.6 i	C 16 SE [OHC]	74/101	09.1991		RFC 42 LZ2E (f)	A5	B30	1,0	F54
	1.6 i	X 16 SZ [OHC]	52/71	09.1991		RC 52 LS (e)	A9	B20	0,7	L65
	1.6 i	C 16 NZ - E 16 NZ [OHC]	55/75	09.1991		RC 52 LS	A9	B20	0,7	L65
	1.6 i	C 16 SE [OHC]	74/101	09.1991		RC 52 LS (e)	A9	B20	0,7	L65
	1.6 i	C 16 LZ2 [OHC]		09.1993		RFC 42 LZ2E	A5	B30	1,0	F54
	1.6 i 16V	X 16 XEL [DOHC]	74/101	09.1993		RFC 42 LZ2E	A5	B30	1,0	F54
	1.6 i KAT	C 16 LZ/C 16 NZ	55/75	10.1987	02.1993	RC 62 LS5	A24		1,1	L65-5
	1.6 S, S Estate	16 S - 16 SV [OHC]	55-60/75-82		08.1991	RC 62 LS	A6	B17	0,7	L65
	1.8 i	C 18 NZ [OHC II]	66/90	09.1991		RFC 42 LZ2E (f)	A5	B30	1,0	F54
	1.8 i	C 18 NZ [OHC II]	66/90	09.1991		RC 52 LS (e)	A9	B20	0,7	L65
	1.8 i 16V	X 18 XE [DOHC]	85/115	09.1993		RFC 42 LZ2E	A5	B30	1,0	F54
	1.8 i 16V	C 18 XE [DOHC]		09.1994		RFC 42 LZ2E	A5	B30	1,0	F54
	1.8 i GTE	18 E - 18 SE [OHC]	82-85/112-115		08.1991	RC 62 LS	A6	B17	0,7	L65
	2.0 GTE 16V	20 XE	115/156	05.1988	08.1991	RFN 52 LZ	A27		0,9	F54
	2.0 i	C 20 NE [OHC]	85/115	09.1991		RFC 42 LZ2E (f)	A5	B30	1,0	F54
	2.0 i	C 20 NE [OHC]	85/115	09.1991		RC 52 LS (e)	A9	B20	0,7	L65
	2.0 i 16V	C 20 XE [DOHC]	110/150	09.1984	08.1992	RFN 58 LZ (b)	A7	B28	0,9	F54
	2.0 i 16V	20 XE [DOHC]	115/156	09.1984	08.1992	RFN 58 LZ (b)	A7	B28	0,9	F54
	2.0 i 16V	C 20 XE	110/150	09.1991	08.1992	RFN 52 LZ	A27		0,9	F54
	2.0 i 16V	C 20 XE [DOHC]	110/150	09.1992	02.1998	RFC 42 LZ2E	A5	B30	1,0	F54
	2.0 i 16V	20 XE [DOHC]	115/156	09.1992	02.1998	RFC 42 LZ2E	A5	B30	1,0	F54
	2.0 i 16V	X 20 XEV [DOHC]	100/136	01.1995		RFC 42 LZ2E	A5	B30	1,0	F54
	2.0 i 16V	C 20 XE [DOHC]	110/150	09.1984	08.1992	RFN 58 LZ3A (g)	A515		0,9	
	2.0 i 16V	20 XE [DOHC]	115/156	09.1984	08.1992	RFN 58 LZ3A (g)	A515		0,9	
	2.0 i 16V GTE 16V	20 XEH [DOHC]	110/150		08.1991	RFC 58 LS	A18		0,8	F54
	2.0 i GTE	20 SEH [OHC II]	95/129		08.1991	RC 62 LS	A6	B17	0,7	L65
ASTRA Mk V (H) CC	2.0 Turbo	Z 20 LEH	177/241	01.2004	05.2009	RFC 62 LSDP5	A507		1,1	
ASTRA Mk V (H)	2.0 i 16V Turbo	Z 20 LEH	176/239	02.2009		RFC 62 LSDP5	A507		1,1	
Sport Hatch										
ASTRAVAN	1.4 i	C 14 NZ	44/60	01.1991	10.1994	RC 52 LS	A9	B20	0,8	L65
	1.6 i	C 16 NZ	55/75	01.1991	08.1998	RC 52 LS	A9	B20	0,8	L65
BELMONT	1.3	13 S [OHC]	55/75	09.1985	09.1993	RC 62 LS	A6	B17	0,7	L65
	1.6	16 S - 16 SV [OHC]	55-60/75-82	09.1985	09.1993	RC 62 LS	A6	B17	0,7	L65
	1.8 i	18 E [OHC]	85/115	09.1985	09.1993	RC 62 LS	A6	B17	0,7	L65
BRAVA	2.3 i	4ZD1	65-72/88-98	06.1990		RC 62 LS	A6	B17	0,7	L65
CALIBRA	2.0 i 16V	C 20 XE [DOHC]	110/150	03.1990	08.1992	RFN 58 LZ (b)	A7	B28	0,9	F54
	2.0 i 16V	C 20 XE [DOHC]	110/150	09.1992	04.1997	RFC 42 LZ2E	A5	B30	1,0	F54
	2.0 i 16V	X 20 XEV [DOHC]	100/136	11.1993	04.1997	RFC 42 LZ2E	A5	B30	1,0	F54
	2.0 i 16V	C 20 XE [DOHC]	110/150	03.1990	08.1992	RFN 58 LZ3A (g)	A515		0,9	
	2.0 i 16V, 4x4	C 20 XE	110/150	06.1990	02.1994	RFN 52 LZ	A27		0,9	F54
	2.0 i 4x4, GT	C 20 NE [OHC]	85/115	06.1990	04.1997	RFC 42 LZ2E (f)	A5	B30	1,0	F54
	2.0 i 4x4, GT	C 20 NE [OHC]	85/115	06.1990	04.1997	RC 52 LS (e)	A9	B20	0,7	L65
	2.0 i Turbo 4x4	C 20 LET [DOHC]	150/204	03.1992	04.1997	RFC 58 LZE5	A75		1,1	F54-5
	2.0 i Turbo 4x4	C 20 LET	150/204	03.1992	07.1997	RFN 52 LZ	A27		0,9	F54
	2.5 i V6	C 25 XE [DOHC]	125/170	04.1993	04.1997	RFC 42 LZ2E	A5	B30	1,0	F54
	2.5 i V6 24V	X 25 XE [DOHC]	125/170	04.1993	04.1997	RFC 42 LZ2E	A5	B30	1,0	F54
CARLTON	1.8	18 NV - 18 SV - S 18 NV - E 18 NVR - 18 S [OHC, OHC II]	55-66/75-90	09.1986	10.1994	RC 62 LS	A6	B17	0,7	L65



(1) Available until end of stock

- (a) 30 000 km
- (b) 60 000 km
- (c) Grey sticker on ignition coil
- (d) Green sticker on ignition coil

- (e) Hex 21 mm
- (f) Hex 16 mm
- (g) Recommended for cold weather



kW/HP



Box
10

Blister
4



F3-D1

VAUXHALL

	1.8 i	18 SE [OHC II]	85/115	09.1986	10.1994	RC 62 LS	A6	B17	0,7	L65
	1.8 i, Estate	18 SEH	85/115	09.1986	03.1994	RC 52 LS	A9	B20	0,8	L65
	1.8 S	18 S [OHC]	66/90	12.1982	08.1986	RC 62 LS	A6	B17	0,7	L65
	2.0 i	20 SE [OHC]	85/115	09.1986	10.1994	RFC 42 LZ2E	A5	B30	1,0	F54
	2.0 i	20 SE [OHC]	90/122	09.1986	10.1994	RC 62 LS	A6	B17	0,7	L65
	2.0 i	X 20 SE [OHC]	85/115	01.1994		RFC 42 LZ2E	A5	B30	1,0	F54
	2.0 i 16V CD, GL	X 20 XEV [DOHC]	100/136	01.1994		RFC 42 LZ2E	A5	B30	1,0	F54
	2.0 i CD, Century, GL, GLT	C 20 NE [OHC]	74/101	09.1986	10.1994	RC 52 LS	A9	B20	0,8	L65
	2.0 S	20 S	74/101	10.1978	08.1986	RC 42 S	A69	B23	0,7	N43
	2.2 i	22 E	85/115	11.1984	08.1986	RC 42 S	A69	B23	0,7	N43
	2.4 i CD, GL, GLS	C 24 NE	92/125	09.1986	10.1994	RC 42 S	A69	B23	0,7	N43
	2.5 i V6 24V CD	X 25 XE [DOHC]	125/170	01.1994		RFC 42 LZ2E	A5	B30	1,0	F54
	2.6 i V6	C 26 NE	110/150	09.1986	10.1994	RC 42 S	A69	B23	0,7	N43
	3.0 24V GSi 3000	C 30 SEJ [DOHC]	147-150/200-204	01.1990	10.1994	RFC 58 LZ2E	A10	B31	0,9	F54
	3.0 3000 24V, Estate	C 30 SE	150/204	09.1989	03.1994	RFC 58 LZK (a)	A11	B29	0,8	F54
	3.0 i 24V GSi 3000	C 30 SE [DOHC]	147-150/200-204	01.1990	10.1994	RFC 58 LZ2E	A10	B31	0,9	F54
	3.0 i GSi 3000	30 NE	130/177	03.1987	10.1994	RC 42 S	A69	B23	0,7	N43
	3.0 i V6 24V	X 30 XE [DOHC]	155-169/211-230	01.1994		RFC 42 LZ2E	A5	B30	1,0	F54
	3.0 i V6 CDX, Estate			08.1989	08.1990	RC 42 S	A69	B23	0,7	N43
	3000 24V, Estate	C 30 SEJ	147/200	09.1989	03.1994	RFC 58 LZK (a)	A11	B29	0,8	F54
CAVALIER	1.3			08.1977	08.1981	RC 62 LS5	A24		1,1	L65-5
	1.3 S	13 S [OHC]	55-56/75-76	09.1981	08.1988	RC 62 LS	A6	B17	0,7	L65
	1.4	14 NV [OHC]	55/75	09.1988	08.1995	RFC 42 LZ2E (f)	A5	B30	1,0	F54
	1.4	14 NV [OHC]	55/75	09.1988	08.1995	RC 52 LS (e)	A9	B20	0,7	L65
	1.4 i	E 14 NZ [OHC I]	44/60	09.1993	08.1995	RC 62 LS	A6	B17	0,7	L65
	1.6	16 SH [OHC]	66/90	09.1986	08.1988	RFC 42 LZ2E (f)	A5	B30	1,0	F54
	1.6	16 SV [OHC]	60/82	09.1986	08.1995	RC 62 LS	A6	B17	0,7	L65
	1.6	16 SH [OHC]	60-67/82-91	09.1986	08.1988	RC 62 LS	A6	B17	0,7	L65
	1.6	16 SH [OHC]	66/90	09.1986	08.1988	RC 52 LS (e)	A9	B20	0,7	L65
	1.6 i	E 16 NZ [OHC]	55/75	09.1988	08.1995	RFC 42 LZ2E (f)	A5	B30	1,0	F54
	1.6 i	C 16 NZ [OHC]	55-60/75-82	09.1988	08.1995	RFC 42 LZ2E (f)	A5	B30	1,0	F54
	1.6 i	E 16 NZ [OHC]	55/75	09.1988	08.1995	RC 52 LS (e)	A9	B20	0,7	L65
	1.6 i	C 16 NZ [OHC]	55-60/75-82	09.1988	08.1995	RC 52 LS (e)	A9	B20	0,7	L65
	1.6 i	X 16 SZ [OHC]	52/71	09.1994	08.1995	RFC 42 LZ2E (f)	A5	B30	1,0	F54
	1.6 i	16 LZ2 [OHC]	55/75	09.1994	08.1995	RFC 42 LZ2E	A5	B30	1,0	F54
	1.6 i	X 16 SZ [OHC]	52/71	09.1994	08.1995	RC 52 LS (e)	A9	B20	0,7	L65
	1.6 S	16 S [OHC]	55/75	10.1975	08.1981	RC 42 S	A69	B23	0,7	N43
	1.6 S	16 S [OHC]	66-67/90-91	10.1975	08.1981	RC 62 LS	A6	B17	0,7	L65
	1.8	18 SV [OHC, OHC II]	66/90	09.1988	08.1995	RC 62 LS	A6	B17	0,7	L65
	1.8 i	18 E - 18 SE [OHC]	82/112	09.1981	08.1988	RC 62 LS	A6	B17	0,7	L65
	1.8 i	C 18 NZ [OHC II]	66/90	09.1988	08.1995	RFC 42 LZ2E (f)	A5	B30	1,0	F54
	1.8 i	C 18 NZ [OHC II]	66/90	09.1988	08.1995	RC 52 LS (e)	A9	B20	0,7	L65
	1.8 S	E 18 NVR [OHC II]	65/88	09.1988	08.1995	RC 62 LS	A6	B17	0,7	L65
	1.9 S	19 S	66/90	08.1975	03.1978	RC 42 S	A69	B23	0,7	N43
	2.0 i	C 20 NE [OHC]	85/115	09.1986	08.1988	RFC 42 LZ2E (f)	A5	B30	1,0	F54
	2.0 i	C 20 NE [OHC]	85/115	09.1986	08.1988	RC 52 LS (e)	A9	B20	0,7	L65
	2.0 i 16V	X 20 XEV [DOHC]	100/136	09.1993	08.1995	RFC 42 LZ2E	A5	B30	1,0	F54
	2.0 i 16V 4x4	C 20 XE [DOHC]	110/150	09.1988	08.1991	RFC 58 LS	A18		0,8	F54
	2.0 i 16V 4x4	C 20 XE [DOHC]	110/150	09.1991	08.1992	RFN 58 LZ (b)	A7	B28	0,9	F54
	2.0 i 16V 4x4	C 20 XE [DOHC]	110/150	09.1992	08.1995	RFC 42 LZ2E	A5	B30	1,0	F54
	2.0 i 16V 4x4	C 20 XE [DOHC]	110/150	09.1991	08.1992	RFN 58 LZ3A (g)	A515		0,9	
	2.0 i 16V GSi	20 XE [DOHC]	115/156	09.1988	08.1991	RFC 58 LS	A18		0,8	F54
	2.0 i 16V GSi	20 XE [DOHC]	115/156	09.1991	08.1992	RFN 58 LZ (b)	A7	B28	0,9	F54
	2.0 i 16V GSi	20 XE [DOHC]	115/156	09.1992	08.1995	RFC 42 LZ2E	A5	B30	1,0	F54
	2.0 i 16V GSi	20 XE [DOHC]	115/156	09.1991	08.1992	RFN 58 LZ3A (g)	A515		0,9	
	2.0 i 16V, 4x4	C 20 XE	110/150	09.1988	08.1992	RFN 52 LZ	A27		0,9	F54
	2.0 i 4x4, L, LS, GLS, SRI	20 SE - SEH [OHC]	95/129	03.1987	08.1995	RC 62 LS	A6	B17	0,7	L65
	2.0 S	20 S	74/101	03.1978	08.1981	RC 42 S	A69	B23	0,7	N43
	2.5 i V6	C 25 XE [DOHC]	125/170	02.1993	08.1993	RFC 58 LZ2E	A10	B31	0,9	F54
	2.5 i V6 24V	25 XE [DOHC]	125/170	02.1993	08.1993	RFC 58 LZ2E	A10	B31	0,9	F54
	2.5 i V6 24V	25 XE [DOHC]	125/170	09.1993	08.1995	RFC 42 LZ2E	A5	B30	1,0	F54
	2.5 V6	C 25 XE	125/170	02.1993	08.1993	RFC 58 LZK (a)	A11	B29	0,8	F54
CHEVANNE	1.3	13 N [OHV]	39/53	10.1980	12.1985	RC 72 LS	A32	B26	0,7	L87
CHEVETTE	1.3 E, GL, L	13 S [OHV]	42/57	10.1980	12.1985	RC 72 LS5	A116		1,0	L87

(f) Available until end of stock

(a) 30 000 km

(b) 60 000 km

(c) Grey sticker on ignition coil

(d) Green sticker on ignition coil

(e) Hex 21 mm

(f) Hex 16 mm

(g) Recommended for cold weather

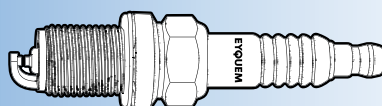

EYQUEM



Box 10
Blister 4



VAUXHALL

COMBO	1.2 i	12 NZ - C 12 NZ - X 12 SZ [OHC]	33/45	03.1994		RFC 42 LZ2E (f)	A5	B30	1,0	F54
	1.2 i	12 NZ - C 12 NZ - X 12 SZ [OHC]	33/45	03.1994		RC 52 LS (e)	A9	B20	0,7	L65
	1.4 i	C 14 NZ [DOHC]	44/60	07.1994		RFC 42 LZ2E (f)	A5	B30	1,0	F54
	1.4 i	C 14 NZ [DOHC]	44/60	07.1994		RC 52 LS (e)	A9	B20	0,7	L65
	1.4 i	X 14 SZ [OHC]	44/60	04.1996		RFC 42 LZ2E	A5	B30	1,0	F54
	1.4 i Si	C 14 SE [OHC]	60/82	07.1994		RFC 42 LZ2E (f)	A5	B30	1,0	F54
	1.4 i Si	C 14 SE [OHC]	60/82	07.1994		RC 52 LS (e)	A9	B20	0,7	L65
CORSA	1.0 i 12V	X 10 XE	40/54	03.1997		RFC 42 LZ2E	A5	B30	1,0	F54
	1.2 i	12 NZ - C 12 NZ - X 12 SZ [OHC]	33/45	08.1993		RFC 42 LZ2E (f)	A5	B30	1,0	F54
	1.2 i	12 NZ - C 12 NZ - X 12 SZ [OHC]	33/45	08.1993		RC 52 LS (e)	A9	B20	0,7	L65
	1.2 i 16V	X 12 XE [DOHC]	48/65	09.1997		RFC 42 LZ2E	A5	B30	1,0	F54
	1.2 i 16V	Z 12 XE Ecotec [DOHC]	55/75	09.2000		RFC 42 LZ2E	A5	B30	1,0	F54
	1.4 i	C 14 NZ [DOHC]	44/60	03.1993	10.1996	RFC 42 LZ2E (f)	A5	B30	1,0	F54
	1.4 i	C 14 NZ [DOHC]	44/60	03.1993	10.1996	RC 52 LS (e)	A9	B20	0,7	L65
	1.4 i	X 14 SZ [DOHC]	44/60	04.1996		RFC 42 LZ2E	A5	B30	1,0	F54
	1.4 i 16V	X 14 XE [DOHC]	66/90	11.1994		RFC 42 LZ2E	A5	B30	1,0	F54
	1.4 i Si	C 14 SE [OHC]	60/82	08.1993		RFC 42 LZ2E (f)	A5	B30	1,0	F54
	1.4 i Si	C 14 SE [OHC]	60/82	08.1993		RC 52 LS (e)	A9	B20	0,7	L65
	1.6 i	C 16 XE [DOHC]	80/109	08.1993		RFC 42 LZ2E	A5	B30	1,0	F54
	1.6 i 16V	X 16 XE [DOHC]	78/106	09.1994		RFC 42 LZ2E	A5	B30	1,0	F54
		Z 10 XE Ecotec [DOHC]	40/54			RFC 42 LZ2E	A5	B30	1,0	F54
FRONTERA	2.0 i	C 20 NE [OHC]	85/115	01.1992		RFC 42 LZ2E (f)	A5	B30	1,0	F54
	2.0 i	C 20 NE [OHC]	85/115	01.1992		RC 52 LS (e)	A9	B20	0,7	L65
	2.0 i	X 20 SE [OHC]	85/115	02.1995		RFC 42 LZ2E	A5	B30	1,0	F54
	2.2 i 16V	X 22 XE [DOHC]	100/136	02.1995		RFC 42 LZ2E	A5	B30	1,0	F54
	2.2 i	Y 22 SE	100/136	10.1998		RFN 58 LZDP5	A187		1,1	
	2.4 i	C 24 NE	92/125	01.1992		RC 42 S	A69	B23	0,7	N43
	3.2 i	6 VD1	151/205	10.1998		RFC 52 LS5	A26	B24	1,1	F54-5
	3.2 i	Y 32 NE	151/205	10.1998	10.2004	RFN 58 LZDP5	A187		1,1	
HA	1.3 Van	[OHV]	32/44	10.1980	12.1985	RC 72 LS	A32	B26	0,7	L87
MONTEREY	3.2 i 24V	6 VD 1	130/177	06.1992		RFC 58 LS5	A38	B48	1,1	F54-5
NOVA	1.0	10 S [OHV]	33/45	05.1983	03.1993	RC 42 S	A69	B23	0,7	N43
	1.2	12 NC - 12 NV [OHV]	33/45	05.1983	03.1993	RC 62 LS	A6	B17	0,7	L65
	1.2	12 S	40-43/54-58	05.1983	10.1987	RC 62 LS	A6	B17	0,7	L65
	1.2	12 ST [OHC]	37-40/50-54	01.1990	03.1993	RC 42 S	A69	B23	0,7	N43
	1.2 i	C 12 NZ [OHC]	33/45	09.1990	03.1993	RFC 42 LZ2E (f)	A5	B30	1,0	F54
	1.2 i	C 12 NZ [OHC]	33/45	09.1990	03.1993	RC 52 LS (e)	A9	B20	0,7	L65
	1.3	13 S - 13 SB [OHC]	51/69	05.1983	03.1993	RC 62 LS	A6	B17	0,7	L65
	1.4	14 NV [OHC]	55/75	01.1990	03.1993	RFC 42 LZ2E (f)	A5	B30	1,0	F54
	1.4	14 NV [OHC]	55/75	01.1990	03.1993	RC 52 LS (e)	A9	B20	0,7	L65
	1.4 i	C 14 NZ [OHC]	44/60	01.1990	03.1993	RFC 42 LZ2E (f)	A5	B30	1,0	F54
	1.4 i	C 14 NZ [OHC]	44/60	01.1990	03.1993	RC 52 LS (e)	A9	B20	0,7	L65
	1.4 i Si	C 14 SE [OHC]	60/82	09.1991	03.1993	RC 62 LS	A6	B17	0,7	L65
	1.6 i	C 16 SE [OHC]	74/101	05.1988	03.1993	RFC 42 LZ2E (f)	A5	B30	1,0	F54
	1.6 i	C 16 SE [OHC]	74/101	05.1988	03.1993	RC 52 LS (e)	A9	B20	0,7	L65
	1.6 i GSi, GTE	E 16 SE [OHC I]	72-74/98-100	05.1988	03.1993	RC 62 LS	A6	B17	0,7	L65
OMEGA	2.0 i	20 SE - X 20 SE [OHC]	85/115	01.1994		RFC 42 LZ2E	A5	B30	1,0	F54
	2.0 i 16V	X 20 XEV [DOHC]	100/136	01.1994		RFC 42 LZ2E	A5	B30	1,0	F54
	2.5 i V6 24V	X 25 XE [DOHC]	125/170	01.1994		RFC 42 LZ2E	A5	B30	1,0	F54
	2.6 V6, Estate	Y 26 SE	132/180	09.2000		RFC 42 LZ4E	A154		1,6	
	3.0 i V6 24V	X 30 XE [DOHC]	148/201	01.1994		RFC 42 LZ2E	A5	B30	1,0	F54
	3.2 V6, Estate	Y 32 SE	160/218	02.2001		RFC 42 LZ4E	A154		1,6	
ROYALE	2.2 E	22 E	85/115	11.1984	08.1987	RC 42 S	A69	B23	0,7	N43
	2.5 E	25 E	103/140	09.1984	08.1987	RC 42 S	A69	B23	0,7	N43
	2.8 S	28 S	95/129		12.1982	RC 42 S	A69	B23	0,7	N43
	2.9	C 30 LE	115/156	09.1985	08.1987	RC 42 S	A69	B23	0,7	N43
	3.0 i E	30 E	132/180		12.1982	RC 42 S	A69	B23	0,7	N43
SENATOR	2.5 i	25 E	100-140/136-190	09.1984	12.1989	RC 42 S	A69	B23	0,7	N43
	2.6 i V6	C 26 NE	110/150	09.1990	08.1993	RC 42 S	A69	B23	0,7	N43
	3.0 24V	C 30 SE	150/204	09.1989	09.1993	RFC 58 LZK (a)	A11	B29	0,8	F54
	3.0 i	30 E	132/180	01.1983	08.1987	RC 42 S	A69	B23	0,7	N43

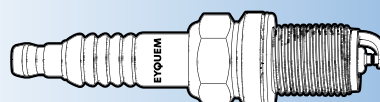

(1) Available until end of stock

- (a) 30 000 km
(b) 60 000 km
(c) Grey sticker on ignition coil
(d) Green sticker on ignition coil

- (e) Hex 21 mm
(f) Hex 16 mm
(g) Recommended for cold weather



KW/HP



Box 10
Blister 4



F3-1

VAUXHALL

	3.0 i	C 30 NE	115-130/156-177	09.1987	08.1993	RC 42 S	A69	B23	0,7	N43
	3.0 i 24V	C 30 SE [DOHC]	150/204	09.1989	08.1993	RFC 58 LZ2E	A10	B31	0,9	F54
	3.0 i V6	C 30 LE	115-130/156-177	09.1987	08.1993	RC 42 S	A69	B23	0,7	N43
SIGNUM	2.0 i Turbo		129/175	05.2003		RFN 62 LZDP5	A185		1,0	
	2.0 i Turbo	Z 20 NET	129/175	01.2002	10.2008	RFC 62 LZDP5	A507		1,1	
SINTRA	2.2 i 16V CD, GLS	X 22 XE [DOHC]	104/141	03.1996		RFC 42 LZ2E	A5	B30	1,0	F54
	3.0 i V6 24V CD, GLS	X 30 XE [DOHC]	148/201	03.1996		RFC 42 LZ2E	A5	B30	1,0	F54
TIGRA	1.4 i 16V	X 14 XE [DOHC]	66/90	11.1994		RFC 42 LZ2E	A5	B30	1,0	F54
	1.6 i 16V	X 16 XE [DOHC]	78/106	11.1994		RFC 42 LZ2E	A5	B30	1,0	F54
VECTRA	1.4 [86_, 87_]	14 NV [OHC]	55/75	09.1988		RC 62 LS	A6	B17	0,7	L65
	1.6 [86_, 87_]	16 SV [OHC]	60/82	09.1988		RC 62 LS	A6	B17	0,7	L65
	1.6 i	C 16 NZ - E 16 NZ [OHC]	55/75	09.1988		RC 52 LS	A9	B20	0,7	L65
	1.6 i	C 16 NZ - E 16 NZ [OHC]	55/75	09.1988		RFC 42 LZ2E	A5	B30	1,0	F54
	1.6 i	16 LZ2 - X 16 SZR [OHC]	55/75	09.1995		RFC 42 LZ2E	A5	B30	1,0	F54
	1.6 i [86_, 87_]	X 16 SZ [OHC]	52/71	09.1988		RFC 42 LZ2E (f)	A5	B30	1,0	F54
	1.6 i [86_, 87_]	X 16 SZ [OHC]	52/71	09.1988		RC 52 LS (e)	A9	B20	0,7	L65
	1.6 i 16V	X 16 XEL [DOHC]	74/101	09.1995		RFC 42 LZ2E	A5	B30	1,0	F54
	1.8	18 SV - C 18 SV - E 18 MVR [OHC, OHC II]	65-66/88-90	09.1988	08.1995	RC 62 LS	A6	B17	0,7	L65
	1.8 i [86_, 87_]	C 18 NZ [OHC II]	66/90	03.1990		RFC 42 LZ2E (f)	A5	B30	1,0	F54
	1.8 i [86_, 87_]	C 18 NZ [OHC II]	66/90	03.1990		RC 52 LS (e)	A9	B20	0,7	L65
	1.8 i 16V	X 18 XE [DOHC]	85/115	09.1995		RFC 42 LZ2E	A5	B30	1,0	F54
	2.0 16V Turbo, Mk II GTS		129/175	03.2003		RFN 62 LZDP5	A185		1,0	
	2.0 16V Turbo, Mk II, Estate		129/175	03.2003		RFN 62 LZDP5	A185		1,0	
	2.0 i	20 NE - C 20 NE [OHC]	85/115	09.1988		RC 52 LS	A9	B20	0,7	L65
	2.0 i	20 NE - C 20 NE [OHC]	85/115	09.1988		RFC 42 LZ2E	A5	B30	1,0	F54
	2.0 i	20 NEJ [OHC]	82/112	09.1995		RFC 42 LZ2E	A5	B30	1,0	F54
	2.0 i [86_, 87_]	20 SEH [OHC II]	95/129	09.1988		RC 62 LS	A6	B17	0,7	L65
	2.0 i 16V	C 20 XE - 20 XE [DOHC]	110-115/150-156		08.1992	RFC 58 LZ2E	A10	B31	0,9	F54
	2.0 i 16V CDX	C 20 XE - 20 XE - X 20 XEV [DOHC]	100-115/1136-156	09.1995	03.2002	RFC 42 LZ2E	A5	B30	1,0	F54
	2.0 i Turbo [86_, 87_]	C 20 LET [DOHC]	150/204	09.1992	08.1995	RFC 58 LZ2E	A75		1,1	F54-5
	2.5 i V6	C 25 XE [DOHC]	125/170	09.1993		RFC 42 LZ2E	A5	B30	1,0	F54
	2.5 i V6 [86_, 87_]	C 25 XE [DOHC]	125/170		08.1993	RFC 58 LZ2E	A10	B31	0,9	F54
	2.5 i V6 24V	25 XE [DOHC]	125/170	09.1993		RFC 42 LZ2E	A5	B30	1,0	F54
	2.5 i V6 24V	X 25 XE [DOHC]	125/170	09.1995		RFC 42 LZ2E	A5	B30	1,0	F54
	2.5 i V6 24V [86_, 87_]	25 XE [DOHC]	125/170		08.1993	RFC 58 LZ2E	A10	B31	0,9	F54
	2.6 i V6, Estate	Y 26 SE	125/170	09.2000		RFC 42 LZ4E	A154		1,6	
VECTRA Mk II (C)	2.0 16V Turbo	Z 20 NET	129/175	01.2000	10.2008	RFC 62 LZDP5	A507		1,1	
	2.8 V6 Turbo	Z 28 NEL	169/230	08.2005	07.2008	RFC 58 HZEDP5	A191		1,1	
VECTRA Mk II (C) Estate	2.0 16V Turbo	Z 20 NET	129/175	10.2003	07.2008	RFC 62 LZDP5	A507		1,1	
	2.8 V6 Turbo	Z 28 NEL	169/230	08.2005	07.2008	RFC 58 HZEDP5	A191		1,1	
	2.8 V6 Turbo	Z 28 NET	188/256	08.2006	07.2008	RFC 58 HZEDP5	A191		1,1	
VECTRA Mk II (C) GTS	2.0 16V Turbo	Z 20 NET	129/175	03.2003	07.2008	RFC 62 LZDP5	A507		1,1	
	2.8 V6 Turbo	Z 28 NEL	169/230	08.2005	07.2008	RFC 58 HZEDP5	A191		1,1	
	2.8 V6 Turbo	Z 28 NET	188/256	08.2005	07.2008	RFC 58 HZEDP5	A191		1,1	
VICEROY	2500 : 2.5	25 S	85/115	10.1980	12.1982	RC 42 S	A69	B23	0,7	N43
VIVA	1300 : 1.3			01.1972	12.1979	C 62 LS	A4	B5	1,0	L65
VIVARO Combi	2.0 16V	F4R 720	88/120	08.2001		RFC 62 LZDP5	A507		1,1	
	2.0 16V	F4R 720	88/120	08.2001		RFN 58 LZDP	A519		0,9	
	2.0 16V	F4R 720	88/120	08.2001		RFC 62 LZDP5	A507		1,1	
	2.0 16V	F4R 720	88/120	08.2001		RFN 58 LZDP	A519		0,9	
ZAFIRA	1.6 i 16V Comfort, Elegance	X 16 XEL [DOHC]	74/101	03.1999		RFC 42 LZ2E	A5	B30	1,0	F54
	1.8 i 16V Elegance	X 18 XE1 [DOHC]	85/115	03.1999		RFC 42 LZ2E	A5	B30	1,0	F54
ZAFIRA Mk II (B)	2.0	Z 20 LEH	176/239	01.2006		RFC 62 LZDP5	A507		1,1	

VENTURI

2.0 4 cyl.	200 :					805 LJSP	A96		0,65	
	2.0 4 cyl.					805 LJSP	A96		0,65	
2.5 4 cyl.	210 : 2.5 i Turbo	Z7U- 730	154/209			805 LJSP	A96		0,65	

VOLKSWAGEN

181	1.5	H	32/44	09.1969	07.1970	C 32	A33		0,6	
	1.6	AG	32/44	08.1970	07.1973	C 32	A33		0,6	
	1.6	AL-AM	35/48	03.1973	02.1979	C 32	A33		0,6	

(f) Available until end of stock

(a) 30 000 km

(b) 60 000 km

(c) Grey sticker on ignition coil

(d) Green sticker on ignition coil

(e) Hex 21 mm

(f) Hex 16 mm

(g) Recommended for

cold weather

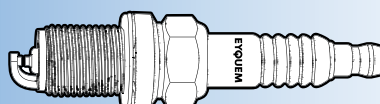

EYQUEM



Box
10

Blister
4



F3 → 1

VOLKSWAGEN

AMAROK (2H_S1B)	2.0 TSI	CFPA	118/160	12.2010		FN 68 LZDPR	A523		0,7	
BEETLE (5C1,5C2)	NEW 1.2 TSI	CBZB	77/105	07.2011		FN 68 LZIPFRS	A548		0,7	
	NEW 1.2 TSI 16V	CYVD	77/105	12.2014		ZN 62 LSDPFRSO	A538		0,75	
	NEW 1.4 TSI	CZDA	110/150	12.2014		ZN 62 LSDPFRSO	A538		0,75	
	NEW 1.4 TSI	CAVD/CNWA	118/160	10.2011		FN 72 LZIPFRS	A551		0,7	
	NEW 2.0 TSI	CPLA	155/211	12.2012		FN 72 HZIPRSO	A537		0,75	
	NEW 2.0 TSI	CULC	162/220	12.2014		FN 72 HZIPRSO	A537		0,75	
	1.4 TSI	CAVD	118/160	04.2011		FC 62 LSDPR	A522		0,9	
	2.0 TSI	CCTA/CBFA	147/200	04.2011		FN 68 LZDPR	A523		0,7	
	2.5	CBTA/CBUA/CCCA	125/170	04.2011		FN 58 LZKFR5	A521		1,05	
BEETLE Cabriolet (5C7, 5C8)	NEW 1.2 TSI 16V	CYVD	77/105	12.2014		ZN 62 LSDPFRSO	A538		0,75	
	NEW 1.4 TSI	CZDA	110/150	12.2014		ZN 62 LSDPFRSO	A538		0,75	
	NEW 1.4 TSI	CAVD/CNWA/GTHD/CTKA	118/160	12.2011		FN 72 LZIPFRS	A551		0,7	
	2.0 TSI	CBFA/CCTA/CCZA	147/200	12.2011		FN 68 LZDPR	A523		0,7	
	NEW 2.0 TSI	CPLA	155/201	12.2012		FN 72 HZIPRSO	A537		0,75	
	NEW 2.0 TSI	CULC	162/220	12.2014		FN 72 HZIPRSO	A537		0,75	
BORA	1.6 i	ATN	77/105	11.1999	05.2000	RFC 58 LZ3EX	A58	B55	0,9	F54
	1.6 i 16V	AJV	88/120	02.1999		RFC 58 LZ3EX	A58	B55	0,9	F54
	1.6 i Comfort	AHL	74/101	10.1998		RFC 58 LZ3EX	A58	B55	0,9	F54
	1.6 i Comfort, Variant	AEH - AKL - APF [OHC]	74/101	09.1998		RFC 58 LZ3EX	A58	B55	0,9	F54
	1.8 i 20V 4 Motion, 4 Motion Variant	AGN [DOHC]	92/125	09.1998		RFC 58 LZ3EX	A58	B55	0,9	F54
	2.0	AZH	85/115	05.1999		RFC 58 LZ3EX	A58	B55	0,9	F54
	2.0	APK	85/115	05.1999		RFC 58 LZ3EX	A58	B55	0,9	F54
	2.0	AQY	85/115	05.1999		RFC 58 LZ3EX	A58	B55	0,9	F54
	2.0	AZG	85/115	05.1999		RFN 52 LZDPF5	A153		1,0	
	2.0	AZJ	85/115	05.1999		RFN 52 LZDPF5	A153		1,0	
	2.0 4motion	AZH	85/115	04.2000		RFC 58 LZ3EX	A58	B55	0,9	F54
	2.0 4motion	AZJ	85/115	04.2000		RFN 52 LZDPF5	A153		1,0	
	2.0 i Comfort, Sport, Variant	APK - AQY	85/115	09.1998		RFC 58 LZ3EX	A58	B55	0,9	F54
	2.3 i V5 20V	AQN	125/170	10.2000		RFN 52 LZDPF5	A153		1,0	
		AQP	150/204	05.1999		RFN 52 LZDPF5	A153		1,0	
BORA (1J2)	1.4 16V	AHW	55/75	03.2000	05.2005	RFC 58 LZ3EX	A58	B55	0,9	F54
	1.4 16V	APE	55/75	03.2000	05.2005	RFC 58 LZ3EX	A58	B55	0,9	F54
	1.4 16V	AXP	55/75	03.2000	05.2005	RFC 58 LZ3EX	A58	B55	0,9	F54
	1.4 16V	AKQ	55/75	03.2000	05.2005	RFC 58 LZ3EX	A58	B55	0,9	F54
	1.4 16V	BCA	55/75	03.2000	05.2005	RFN 52 LZDPF5	A153		1,0	
	1.6	AEH/AKL/APF	74/101	10.1998	05.2005	RFC 58 LZ3EX	A58	B55	0,9	F54
	1.6	AVU/BFQ	75/102	08.2000	05.2005	RFC 58 LZ3EX	A58	B55	0,9	F54
	1.6 16V	ATN/AUS	77/105	05.2000	05.2005	RFC 58 LZ3EX	A58	B55	0,9	F54
	1.6 16V	AZD/BCB	77/105	05.2000	05.2005	RFN 52 LZDPF5	A153		1,0	
	1.8	AGN/BAF	92/125	10.1998	05.2005	RFC 58 LZ3EX	A58	B55	0,9	F54
	1.8 4motion	AGN	92/125	02.1999	05.2005	RFC 58 LZ3EX	A58	B55	0,9	F54
	1.8 T	AGU/ARX/AUM/BAE	110/150	05.2000	05.2005	FN 58 LZDPR	A198		0,75	
	1.8 T	AUQ	132/180	03.2002	05.2005	FN 58 LZDPR	A198		0,75	
	2.0	APK/AQY/AZH	85/115	10.1998	05.2005	RFC 58 LZ3EX	A58	B55	0,9	F54
	2.0	AZG/AZJ	85/115	10.1998	05.2005	RFN 52 LZDPF5	A153		1,0	
	2.0 4motion	AZH	85/115	04.2000	05.2005	RFC 58 LZ3EX	A58	B55	0,9	F54
	2.0 4motion	AZJ	85/115	04.2000	05.2005	RFN 52 LZDPF5	A153		1,0	
	2.3 i V5, 4motion	AGZ	110/150	10.1998	10.2000	RFC 42 LZ4E	A154		1,6	
	2.3 i V5, 4motion LPG	AGZ	110/150	10.1998	10.2000	RFC 52 LZ4E	A159		1,6	
	2.3 i V5, 4motion	AQN	125/170	10.2000	05.2005	RFN 52 LZDPF5	A153		1,0	
	2.8 i V6, 4motion	AQP/AUE/BDE	150/204	03.1999	05.2005	RFN 52 LZDPF5	A153		1,0	
BORA Break (1J6)	1.4 16V	BCA/AHW	55/75	09.2001	05.2005	RFC 58 LZ3EX	A58	B55	0,9	F54
	1.4 16V	AXP	55/75	09.2001	05.2005	RFN 52 LZDPF5	A153		1,0	
	1.6	AEH/AKL/APF	74/100	05.1999	05.2005	RFC 58 LZ3EX	A58	B55	0,9	F54
	1.6	AVU/BFQ	75/102	08.2000	05.2005	RFC 58 LZ3EX	A58	B55	0,9	F54
	1.6 16V	ATN/AUS	77/105	02.2000	05.2005	RFC 58 LZ3EX	A58	B55	0,9	F54
	1.6 i 16V	AZD/BCB	77/105	05.2000	05.2005	RFN 52 LZDPF5	A153		1,0	
	1.8 4motion	AGN	92/125	05.1999	05.2005	RFC 58 LZ3EX	A58	B55	0,9	F54
	1.8 T	AGU/ARX/AUM	110/150	05.2000	05.2005	FN 58 LZDPR	A198		0,75	
	1.8 T	AUQ	132/180	05.2002	05.2005	FN 58 LZDPR	A198		0,75	
	2.0	AQY/APK	85/115	05.1999	05.2005	RFC 58 LZ3EX	A58	B55	0,9	F54
	2.0	AZG/AZJ	85/115	05.1999	05.2005	RFN 52 LZDPF5	A153		1,0	

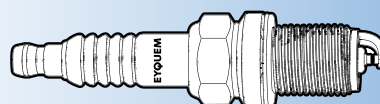

(1) Available until end of stock

- (a) 30 000 km
- (b) 60 000 km
- (c) Grey sticker on ignition coil
- (d) Green sticker on ignition coil

- (e) Hex 21 mm
- (f) Hex 16 mm
- (g) Recommended for cold weather



Box
10

Blister
4



F3-D1

VOLKSWAGEN

	2.0 4motion	AZH	85/115	04.2000	05.2005	RFC 58 LZ3EX	A58	B55	0,9	F54
	2.0 4motion	AZJ	85/115	04.2000	05.2005	RFN 52 LZDPF5	A153		1,0	F54
	2.3 V5, 4motion	AGZ	110/150	05.1999	10.2000	RFC 42 LZ4E	A154		1,6	
	2.3 V5 LPG, 4motion	AGZ	110/150	05.1999	10.2000	RFC 52 LZ4E	A159		1,6	
	2.3 V5, 4motion	AQN	125/170	10.2000	05.2005	RFN 52 LZDPF5	A153		1,0	
	2.8 VR6	AUE	150/204	03.2000	05.2000	RFN 52 LZDPF5	A153		1,0	
	2.8 VR6 4motion	AQP	150/204	05.1999	05.2005	RFN 52 LZDPF5	A153		1,0	
BUS	1.9 Syncro	DF, DG	44/60	08.1982	07.1992	C 62 LS (c)	A4	B5	0,7	L65
	1.9 Syncro	DF, DG	44/60	08.1982	07.1992	C 62 LS3X (d)	A13	B15	0,8	L65
	2.1 Syncro	DJ	82/112	08.1985	07.1992	C 62 LS3X (d)	A13	B15	0,8	L65
	2.1 Syncro	DJ	82/112	08.1985	07.1992	C 72 LS (1) (c)	A30		0,8	L87
	2.1 Syncro	SR	64/87	08.1989	07.1992	C 62 LS3X	A13	B15	0,8	L65
CADDY I (14)	1.5	JB	51/69	08.1982	07.1983	C 52 LS	A1	B1	0,7	L65
	1.6	EW	55/75	08.1982	07.1983	C 62 LS	A4	B5	0,7	L65
	1.6	EW/HN	55/75	08.1983	07.1989	C 52 LS3X	A28	B25	0,9	L65
	1.8	JH	70/95	08.1985	07.1992	RC 58 LZ3EX	A34	B54	0,9	L65
CADDY II Break (9K9B)	1.4 i	ANX	44/60	01.1998		RC 58 LZ3EX	A34	B54	0,9	L65
	1.4 i	AEX/APQ/AKV	44/60	11.1995	01.2004	RC 58 LZ3EX	A34	B54	0,9	L65
	1.4 i	AUD	44/60	11.1995	01.2004	RFN 52 LZDPF5	A153		1,1	
	1.4 i	AUA	55/75	08.2000	01.2004	RFC 58 LZ3EX	A58	B55	0,9	F54
	1.6 i	1F	55/75	11.1995	05.1997	RC 52 LZ3EX	A35		0,9	L65
	1.6 i	AEE	55/75	06.1997	09.2000	RC 58 LZ3EX	A34	B54	0,9	L65
CADDY II Camionnette (9K9A)	1.4 60	AEX/APQ	44/60	11.1995	01.2004	RC 58 LZ3EX	A34	B54	0,9	L65
	1.4 60	AUD	44/60	11.1995	01.2004	RFN 52 LZDPF5	A153		1,1	
	1.4 i	AUA	55/75	08.2000	01.2004	RFC 58 LZ3EX	A58	B55	0,9	F54
	1.6 i	1F	55/75	11.1995	05.1997	RC 52 LZ3EX	A35		0,9	L65
	1.6 i	AEE	55/75	11.1995	09.2000	RC 58 LZ3EX	A34	B54	0,9	L65
CADDY II Pick-up (9U7)	1.6 i	AEE	55/75	06.1996	12.2000	RC 58 LZ3EX	A34	B54	0,9	L65
CADDY III Break (2KB, 2KJ, 2CB, 2CJ)	1.2 TSI	CBZA	63/86	09.2010	05.2015	FN 68 LZPFRS	A548		0,7	
NEW	1.2 TSI	CBZB	77/105	09.2010	05.2015	FN 68 LZPFRS	A548		0,7	
	1.4 i	BCA	55/75	03.2004	05.2006	RFC 58 LZ3EX	A58	B55	0,9	F54
	1.4 i	BUD	59/80	05.2006	08.2010	FN 58 LZKFR5	A521		1,05	
	1.6 i	BRY	74/101	03.2005		RFC 58 LS	A18		0,8	F54
	1.6 i	BGU/BSE/BSF	75/102	04.2004		RFC 58 LZ3EX	A58	B55	0,9	F54
	1.6 i BiFuel	CHGA	75/102	05.2011		RFC 58 LZ3EX	A58	B55	0,9	F54
	2.0 Ecofuel	BSX	80/109	04.2006		RFN 58 LZDP5	A187		1,05	
CADDY III Camionnette (2KA, 2KH, 2CA, 2CH)	1.2 TSI	CBZA	63/86	09.2010	05.2015	FN 68 LZPFRS	A548		0,7	
NEW	1.2 TSI	CBZB	77/105	09.2010	05.2015	FN 68 LZPFRS	A548		0,7	
	1.4 i	BCA	55/75	03.2004	05.2006	RFC 58 LZ3EX	A58	B55	0,9	F54
	1.4 i	BUD	59/80	05.2006	08.2010	FN 58 LZKFR5	A521		1,05	
	1.6 i	BGU/BSE/BSF	75/102	04.2004		RFC 58 LZ3EX	A58	B55	0,9	F54
	1.6 i BiFuel	CHGA	75/102	05.2011		RFC 58 LZ3EX	A58	B55	0,9	F54
	2.0 Ecofuel	BSX	80/109	04.2006		RFN 58 LZDP5	A187		1,05	
CADDY III Variant (2KB, 2KJ, 2CB, 2CJ)	1.2 TSI	CBZA	63/86	09.2010	05.2015	FN 68 LZPFRS	A548		0,7	
CADDY IV break (SAB, SAJ)	1.2 TSI	CYVC	62/84	06.2015		ZN 62 LSDPFRSO	A538		0,75	
NEW	1.4 TGI CNG	CPWA	81/110	06.2015		ZN 62 LSDPFRSO	A538		0,75	
NEW	1.4 TSI	CZCB	92/125	05.2015		ZN 62 LSDPFRSO	A538		0,75	
CADDY IV camionnette (SAA, SAH)	1.2 TSI	CYVC	62/84	06.2015		ZN 62 LSDPFRSO	A538		0,75	
NEW	1.4 TGI CNG	CPWA	81/110	06.2015		ZN 62 LSDPFRSO	A538		0,75	
NEW	1.4 TSI	CZCB	92/125	05.2015		ZN 62 LSDPFRSO	A538		0,75	
CADDY Alltrack break (SAB)	1.2 TSI	CYVC	62/84	06.2015		ZN 62 LSDPFRSO	A538		0,75	
NEW	1.4 TGI CNG	CPWA	81/110	06.2015		ZN 62 LSDPFRSO	A538		0,75	
NEW	1.4 TSI	CZCB	92/125	05.2015		ZN 62 LSDPFRSO	A538		0,75	
CADDY Alltrack camionnette (SAA)	1.2 TSI	CYVC	62/84	06.2015		ZN 62 LSDPFRSO	A538		0,75	
NEW	1.4 TGI CNG	CPWA	81/110	06.2015		ZN 62 LSDPFRSO	A538		0,75	
NEW	1.4 TSI	CZCB	92/125	05.2015		ZN 62 LSDPFRSO	A538		0,75	

(1) Available until end of stock

(a) 30 000 km

(b) 60 000 km

(c) Grey sticker on ignition coil

(d) Green sticker on ignition coil

(e) Hex 21 mm

(f) Hex 16 mm

(g) Recommended for cold weather



EYQUEM



Box
10

Blister
4



F3

VOLKSWAGEN

CALIFORNIA	1.8	PD	48-49/65-67	12.1990	07.1992	C 62 LS3X	A13	B15	0,8	L65
	2.0 i	AAC	62-64/84-87	09.1990		RC 52 LZ3EX	A35		0,9	L65
	2.5 i Syncro	AAF	81/110	11.1990	12.1993	RC 52 LZ3EX	A35		0,9	L65
	2.8 VR6, T4	AES	103/140	11.1995	04.2000	RFC 42 LZ4E	A154		1,6	
CARAVELLE	2.5 i Syncro	ACU	81/110	07.1994		RC 52 LZ3EX	A35		0,9	L65
	2.8 VR6, T4	AES	103/140	11.1995	04.2000	RFC 42 LZ4E	A154		1,6	
COCCINELLE (Brezel)	1.1	M5	18/24	12.1947	12.1953	C 32	A33		0,6	
COCCINELLE (42005)	1.2	M51	22/30	01.1954	07.1965	C 32	A33		0,6	
COCCINELLE 1200 (11)	1.2	D	25/34	01.1960	12.1985	C 32	A33		0,6	
COCCINELLE 1302 (11)	1.2	D	25/34	08.1969	08.1972	C 32	A33		0,6	
COCCINELLE 1303 (13)	1.2	D	25/34	07.1972	02.1976	C 32	A33		0,6	
COCCINELLE 1300 (13)	1.3	E	27/37	08.1965	07.1970	C 32	A33		0,6	
COCCINELLE 1300 (11)	1.3	F	29/40	01.1965	07.1970	C 32	A33		0,6	
COCCINELLE 1302	1.3	AC	29/40	08.1970	07.1975	C 32	A33		0,6	
COCCINELLE 1300 (11)	1.3	AB	32/44	01.1970	01.1973	C 32	A33		0,6	
COCCINELLE 1302 (11)	1.3	AB	32/44	08.1970	08.1972	C 32	A33		0,6	
COCCINELLE 1303 (13)	1.3	AB-AR	32/44	08.1972	07.1975	C 32	A33		0,6	
COCCINELLE 1500 (11)	1.5	H	32/44	08.1966	11.1973	C 32	A33		0,6	
COCCINELLE 1302	1.6	AH-AE-AK	35/48	07.1971	07.1974	C 32	A33		0,6	
COCCINELLE 1303	1.6	AD	35/48	08.1972	12.1979	C 32	A33		0,6	
COCCINELLE 1500	1.6	AD	37/50	07.1970	01.1973	C 32	A33		0,6	
COCCINELLE 1302	1.6	AD	37/50	01.1970	08.1972	C 32	A33		0,6	
COCCINELLE 1303 LS, S	1.6	AD-AJ-AS	37/50	08.1972	12.1979	C 32	A33		0,6	
COCCINELLE 1600	1.6	AF	34/46	05.1973	09.1992	C 32	A33		0,6	
(Mexico)										
COCCINELLE 1600 i	1.6	ACD	34/46	10.1992	12.1992	C 32 LS	A31		0,8	L3
(Mexico)										
	1.6	ACD	34/46	01.1993	07.2003	C 52 LS	A1		0,8	L65
COCCINELLE Cabriolet	1.1	M5	18/24	07.1949	12.1954	C 32	A33		0,6	
(15)										
COCCINELLE Cabriolet	1.3	F	29/40	07.1964	07.1970	C 32	A33		0,6	
Karman (15)										
COCCINELLE Cabriolet	1.2	D	25/34	04.1975	12.1979	C 32	A33		0,6	
1303 (15)										
COCCINELLE Cabriolet	1.3	AC	29/39	08.1970	07.1974	C 32	A33		0,6	
1302 (15)										
COCCINELLE Cabriolet	1.3	AB	32/44	07.1970	03.1981	C 32	A33		0,6	
1303 (15)										
COCCINELLE Cabriolet	1.6	AF	34/46	08.1970	07.1974	C 32	A33		0,6	
1302 (15)										
COCCINELLE Cabriolet	1.6	AH-AE-AK	35/48	08.1970	07.1974	C 32	A33		0,6	
1303 (15)										
COCCINELLE Cabriolet	1.6	AD	37/50	07.1970	06.1979	C 32	A33		0,6	
1302, 1303 (15)										
COCCINELLE Cabriolet	1.5	H	32/44	01.1966	12.1970	C 32	A33		0,6	
1500 (15)										
	1.6	B	35/48	07.1969	07.1970	C 32	A33		0,6	
CORRADO (53i)	1.8 i 16V	KR	98-102/133-139	09.1988	07.1992	RFC 62 LS3X	A59		0,9	F86
	1.8 i 16V	KR	100/136	04.1989	07.1992	RFC 62 LS3X	A59		0,9	F86
	1.8 G60	PG	118/160	09.1988	09.1993	C 72 LS3X	A63		0,8	L87
	2.0 i	2E	85/115	04.1993	09.1994	RC 52 LZ3EX	A35		0,9	L65
	2.0 i	ADY	85/115	07.1994	12.1995	RC 58 LZ3EX	A34	B54	0,9	L65
	2.0 i 16V	9A	100/136	08.1991	12.1995	RFC 62 LZ3EX	A86		0,9	F86
	2.9 VR6	ABV	140/190	08.1995	12.1995	RFC 42 LZ4E	A154		1,6	
	2.9 VR6 LPG	ABV	140/190	08.1995	12.1995	RFC 52 LZ4E	A159		1,6	
CC (358)	NEW 1.4 TSI	CZDA	110/150	05.2015		ZN 62 LSDPFRSO	A538		0,75	
	1.4 TSI	CTHD	118/160	11.2011		FC 62 LSDPR	A522		0,9	
	1.8 TSI	CDA	118/160	11.2011		FN 68 LZDPR	A523		0,7	
	2.0 TSI	CCZB	155/211	02.2012		FN 68 LZDPR	A523		0,7	
DERBY (86)	0.9	HA	29/40	04.1975	01.1982	C 62 LS	A4	B5	0,7	L65
	1.0	GL	29/39	10.1981	10.1986	C 62 LS	A4	B5	0,7	L65
	1.1	HB - HD	37-38/50-52	04.1975	07.1983	C 62 LS	A4	B5	0,7	L65
	1.3	MH	40/54	08.1985	08.1987	C 62 LS (c)	A4	B5	0,7	L65
	1.3	MH	40/54	08.1985	08.1987	C 62 LS3X (d)	A13	B15	0,8	L65
	1.3	HJ	43/58	01.1977	07.1982	C 62 LS	A4	B5	0,7	L65

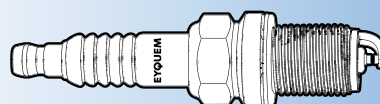

(1) Available until end of stock

- (a) 30 000 km
 (b) 60 000 km
 (c) Grey sticker on ignition coil
 (d) Green sticker on ignition coil

- (e) Hex 21 mm
 (f) Hex 16 mm
 (g) Recommended for cold weather



Box
10

Blister
4



F3-1

VOLKSWAGEN

	1.3	HH	44/60	01.1977	07.1983	C 62 LS	A4	B5	0,7	L65
DERBY (86C, 80)	1.0	GL	29/40	10.1981	12.1984	C 62 LS	A4	B5	0,7	L65
	1.1	HB	37/50	10.1981	07.1983	C 62 LS	A4	B5	0,7	L65
	1.3	HK	40/54	08.1983	07.1985	C 62 LS	A4	B5	0,7	L65
	1.3	HH	44/60	08.1991	07.1983	C 62 LS	A4	B5	0,7	L65
	1.3	GK	55/75	07.1982	12.1984	C 82 LS (c)	A40	B6	0,7	L87
	1.3	GK	55/75	07.1982	12.1984	C 82 LS3X (d)	A92		0,8	L87
EOS (1F7, 1F8)	1.4 TSI	CAXA	90/122	11.2007	08.2015	FC 62 LSDPR	A522		0,9	
	NEW 1.4 TSI	CAVD/CTHD	118/160	05.2008	08.2015	FN 72 LZIFRS	A551		0,7	
	2.0 FSI	BVY	110/150	03.2006	05.2008	FN 62 LZFDPR2A	A192		1,1	
	2.0 FSI	BVZ	110/150	03.2006	05.2008	RFN 58 LZDP5	A187		1,1	
	2.0 FSI LPG	BVZ	110/150	03.2006	05.2008	RFN 62 LZDP5	A185		0,7	
	2.0 TFSI	BPY/BWA/CAWB/ CBFA/CCTA/CCZA	147/200	03.2006	08.2015	FN 68 LZDPR	A523		0,7	
	2.0 TSI	CCZB	155/211	11.2009	08.2015	FN 68 LZDPR	A523		0,7	
EUROVAN	2.5 i	AAF	81/110	09.1991	12.1993	RC 52 LZ3EX	A35		0,9	L65
	2.5 i	ACU	81/110	01.1994	05.1996	RC 52 LZ3EX	A35		0,9	L65
FOX (5Z1, 5Z3)	1.2	CHFB	40/54	04.2005		FN 58 LZKFR5	A521		1,05	
	1.2	BMD	40/54	12.2007		FN 58 LZKFR	A183		0,9	
	1.2	CHFA	44/60	09.2010		FN 58 LZKFR5	A521		1,05	
	1.4 i	BKR	55/75	04.2005		RFN 52 LZDPF5	A153		1,0	
GOLF I (17)	1.1	FA - FJ	37-38/50-52	04.1974	07.1979	C 62 LS	A4	B5	0,7	L65
	1.1	GG	37/50	08.1979	07.1984	C 62 LS	A4	B5	0,7	L65
	1.3	GF-GS	44/60	08.1979	07.1984	C 62 LS	A4	B5	0,7	L65
	1.3	HK	40/54	08.1983	07.1986	C 62 LS	A4	B5	0,7	L65
	1.5	JB	51/69	08.1977	07.1984	C 52 LS	A1	B1	0,7	L65
	1.5	FH	51/70	04.1974	12.1975	C 62 LS	A4	B5	0,7	L65
	1.5	EH	57/78	08.1977	07.1979	C 62 LS	A4	B5	0,7	L65
	1.5	GH	48/65	08.1979	12.1981	C 52 LS	A1	B1	0,7	L65
	1.6	FV	51/69	02.1976	07.1979	C 62 LS	A4	B5	0,7	L65
	1.6	FT	51/69	08.1975	07.1977	C 62 LS	A4	B5	0,7	L65
	1.6	EM-FN-FP	55/75	08.1975	12.1984	C 62 LS	A4	B5	0,7	L65
	1.6	FR	63/86	08.1975	07.1984	C 62 LS	A4	B5	0,7	L65
	1.6 Rivage, Young Line	EW	51-55/69-75	08.1983	12.1992	C 52 LS3X (d)	A28	B25	0,9	L65
	1.6 Rivage, Young Line	RE-HN	53-55/72-75	08.1983	12.1992	C 52 LS3X	A28	B25	0,9	L65
	1.6	EJ	61/83	08.1979	07.1980	C 62 LS	A4	B5	0,7	L65
	1.6 i	EG	81/110	01.1979	07.1982	C 82 LS	A40	B6	0,7	L87
	1.6 i GLi, GTI	EG	81/110	06.1976	07.1982	C 82 LS	A40	B6	0,7	L87
	1.6 i GLi, GTI	EG	81/110	06.1976	07.1982	C 82 LS 3X	A92		0,8	L87
	1.7	EN	57/78	08.1980	07.1984	C 62 LS	A4	B5	0,7	L65
	1.8 Bel Air, Classic Line, Match, Quartett, Sport Line, Young Line	2H - KT	74-82/100-112	08.1982	08.1993	C 62 LS3X	A13	B15	0,8	L65
	1.8 Bel Air, Classic Line, Match, Quartett, Sport Line, Young Line	EX	66/90	08.1983	07.1984	C 72 LS	A30		0,8	L87
	1.8 Bel Air, Classic Line, Match, Quartett, Sport Line, Young Line	JH	70/95	08.1983	08.1993	RC 58 LZ3EX	A34	B54	0,9	L65
	1.8 GTI	DX-JJ	82/112	08.1982	12.1983	C 62 LS3X	A13	B15	0,8	L65
GOLF I Cabriolet (155)	1.5	JB	51/70	01.1979	11.1983	C 52 LS	A1	B1	0,7	L65
	1.6	RE	53/72	04.1986	12.1990	C 52 LS3X	A28	B25	0,9	L65
	1.6	EW-HN	55/75	08.1983	04.1992	C 52 LS3X	A28	B25	0,9	L65
	1.6	EM	55/75	08.1979	07.1983	C 62 LS	A4	B5	0,7	L65
	1.6 i GLi, GTI	EG	81/110	08.1979	07.1982	C 82 LS	A40	B6	0,7	L87
	1.6 i GLi, GTI	EG	81/110	08.1979	07.1982	C 82 LS 3X	A92		0,8	L87
	1.8	EX	66/90	08.1983	07.1985	RC 72 LS	A32		0,8	L87
	1.8	EX	66/90	08.1985	09.1992	RC 58 LZ3EX	A34	B54	0,9	L65
	1.8	JH	70/95	08.1983	04.1993	RC 58 LZ3EX	A34	B54	0,9	L65
	1.8 LPG	JH	70/95	08.1983	04.1993	RC 72 LS	A32		0,7	L87
	1.8	2H	72/98	08.1989	03.1993	C 62 LS3X	A13	B15	0,8	L65
	1.8	DX-EV-PB-KT	82/112	08.1982	12.1989	C 62 LS3X	A13	B15	0,8	L65
GOLF II (19E, 1G1)	1.0	GN	33-37/45-50	08.1983	07.1985	C 62 LS	A4	B5	0,7	L65
	1.0	HZ	37/50	08.1985	07.1988	C 62 LS3X (d)	A13	B15	0,8	L65
	1.0	HZ	37/50	08.1988	07.1989	C 62 LS (c)	A4	B5	0,7	L65
	1.3	HW	37/50	08.1983	07.1984	C 62 LS	A4	B5	0,7	L65
	1.3	NU	37/50	08.1985	08.1988	C 62 LS3X	A13	B15	0,8	L65
	1.3	MH	40/55	08.1983	06.1987	C 62 LS (c)	A4	B5	0,7	L65

- (1) Available until end of stock
 (a) 30 000 km
 (b) 60 000 km
 (c) Grey sticker on ignition coil
 (d) Green sticker on ignition coil

- (e) Hex 21 mm
 (f) Hex 16 mm
 (g) Recommended for cold weather



EYQUEM



Box 10
Blister 4



F3-1

VOLKSWAGEN

1.3	HK	40/55	08.1983	06.1987	RC 72 LS	A32		0,7	L87	
1.3	MH-NZ-2G	40/54	06.1986	12.1992	C 62 LS (c)	A4	B5	0,7	L65	
1.3 i	2C	44/60	08.1985	08.1988	C 62 LS (c)	A4	B5	0,7	L65	
1.3 i	2C	44/60	08.1985	08.1988	C 62 LS3X (d)	A13	B15	0,8	L65	
1.6	PN	51/70	08.1986	07.1992	RC 52 LZ3EX	A35		0,9	L65	
1.6	RF	53/72	02.1986	10.1991	C 52 LS (c)	A1	B1	0,7	L65	
1.6	RF	53/72	02.1986	10.1991	C 52 LS3X (d)	A28	B25	0,9	L65	
1.6	EZ-HM-ABN	55/75	08.1983	07.1992	C 52 LS (c)	A1	B1	0,7	L65	
1.6	EZ-HM-ABN	55/75	08.1983	07.1992	C 52 LS3X	A28	B25	0,9	L65	
1.8 i	RH	62/84	06.1986	07.1987	C 62 LS3X (d)	A13	B15	0,8	L65	
1.8 i	RH	62/84	08.1987	07.1989	C 62 LS (c)	A4	B5	0,7	L65	
1.8 i	RH	62/84	08.1989	07.1990	C 62 LS3X (d)	A13	B15	0,8	L65	
1.8 Syncro	RH	62/84	08.1987	07.1988	RC 72 LS	A32	B26	0,7	L87	
1.8 i	HV	66/90	04.1984	07.1987	C 62 LS3X	A13	B15	0,8	L65	
1.8 i	GU	66/90	04.1984	10.1991	C 62 LS3X	A13	B15	0,8	L65	
1.8 i	GX	66/90	01.1984	07.1988	RC 58 LZ3EX	A34	B54	0,9	L65	
1.8 i CAT	GX-RP	66/90	08.1982	10.1991	RC 58 LZ3EX	A34	B54	0,9	L65	
1.8 Syncro	GX	66/90	02.1986	07.1991	RC 58 LZ3EX	A34	B54	0,9	L65	
1.8 Syncro	GU	66/90	02.1986	07.1991	C 62 LS3X	A13	B15	0,8	L65	
1.8 Syncro CAT	RP	66/90	08.1987	10.1991	RC 58 LZ3EX	A34	B54	0,9	L65	
1.8 Country	MZ	70/95	08.1984	02.1987	C 62 LS3X	A13	B15	0,8	L65	
1.8 Syncro	1P	72/98	02.1986	08.1991	C 62 LS (c)	A4	B5	0,7	L65	
1.8 Syncro	1P	72/98	02.1986	08.1991	C 62 LS3X	A13	B15	0,8	L65	
1.8 GTI	HT-RV	77/105	01.1985	07.1985	C 62 LS3X	A13	B15	0,8	L65	
1.8 i	RG	79/107	08.1985	07.1987	RC 58 LZ3EX	A34	B54	0,9	L65	
1.8 GTI	RD	79/107	08.1985	07.1988	RC 58 LZ3EX	A34	B54	0,9	L65	
1.8 GTI CAT	PF	79/107	01.1987	10.1991	C 62 LS (c)	A4	B5	0,7	L65	
1.8 GTI CAT	PF	79/107	01.1987	10.1991	C 62 LS3X	A13	B15	0,8	L65	
1.8 GTi	DX-JJ	82/112	08.1982	07.1984	C 62 LS3X	A13	B15	0,8	L65	
1.8 GTi	EV	82/112	08.1982	07.1987	C 62 LS3X	A13	B15	0,8	L65	
1.8 GTi	GZ	82/112	08.1983	07.1989	C 62 LS3X	A13	B15	0,8	L65	
1.8 GTi	PB-PF	79-82/107-112	01.1987	10.1991	C 62 LS (c)	A4	B5	0,7	L65	
1.8 GTi	PB-PF	79-82/107-112	01.1987	10.1991	C 62 LS3X (d)	A13	B15	0,8	L65	
1.8 GTi 16V	PL	95/129	02.1986	10.1991	RFC 62 LZ3EX	A86		0,9	F86	
1.8 GTi 16V	KR	100-102/136-139	08.1985	07.1992	RFC 62 LS3X	A59		0,9	F86	
1.8 GTi G60	PG	118/160	01.1990	07.1991	RC 72 LS (1)	A32	B26	0,7	L87	
1.8 GTi G60 Syncro	1H-PG	118/160	01.1990	07.1991	RC 72 LS (1)	A32	B26	0,7	L87	
2.0 i 16V	9A	100/136	07.1989	12.1992	RFC 62 LZ3EX	A86		0,9	F86	
GOLF III (1H1)	1.3 i	ADX	44/60	10.1994	09.1997	RC 58 LZ3EX	A34	B54	0,9	L65
	1.4 i	ABD	44/60	08.1991	07.1995	C 52 LS3X	A28	B25	0,9	L65
	1.4 i	AEX	44/60	10.1994	08.1997	RC 58 LZ3EX	A34	B54	0,9	L65
	1.6 i	ABU	55/75	07.1992	09.1994	C 52 LS3X	A28	B25	0,9	L65
	1.6 i	AEA	55/75	07.1994	07.1995	RC 58 LZ3EX	A34	B54	0,9	L65
	1.6 i	AEE	55/75	07.1995	08.1997	RC 58 LZ3EX	A34	B54	0,9	L65
	1.6 i	AEK	74/101	07.1994	12.1995	RFC 58 LZ3EX	A58	B55	0,9	F54
	1.6 i	AFT	74/101	08.1995	04.1999	RFC 58 LZ3EX	A58	B55	0,9	F54
	1.6 i	AKS	74/101	04.1997		RFC 58 LZ3EX	A58	B55	0,9	F54
	1.8 i	AAM	55/75	08.1991	08.1997	RC 52 LZ3EX	A35		0,9	L65
	1.8 i	ANN	55/75	01.1998		RC 52 LZ3EX	A35		0,9	L65
	1.8 i	ABS-ADZ-ACC	66/90	11.1991	08.1997	RC 58 LZ3EX	A34	B54	0,9	L65
	1.8 i	ANP	66/90	01.1998		RC 58 LZ3EX	A34	B54	0,9	L65
	1.8 i Syncro	ABS-ADZ	66/90	01.1993	08.1997	RC 58 LZ3EX	A34	B54	0,9	L65
	2.0 i	AEP	79/107	10.1994	08.1997	RC 58 LZ3EX	A34	B54	0,9	L65
	2.0 i	2E	85/115	09.1991	09.1994	RC 52 LZ3EX	A35		0,9	L65
	2.0 i	ADY	85/115	07.1994	03.1996	RC 58 LZ3EX	A34	B54	0,9	L65
	2.0 i	AGG	85/115	07.1995	08.1997	RC 58 LZ3EX	A34	B54	0,9	L65
	2.0 i	AKR	85/115	07.1995	08.1997	RC 58 LZ3EX	A34	B54	0,9	L65
	2.0 i Syncro	AGG	85/115	08.1995	08.1997	RC 58 LZ3EX	A34	B54	0,9	L65
	2.0 GTi 16V	ABF	110/150	08.1992	08.1997	RFC 58 LZ3EX	A58	B55	0,9	F54
	2.8 VR6	AAA	128/174	08.1991	08.1997	RFC 42 LZ4E	A154		1,6	
	2.8 VR6 LPG	AAA	128/174	08.1991	08.1997	RFC 52 LZ4E	A159		1,6	
	2.9 VR6, Syncro	ABV	140/190	08.1995	08.1997	RFC 42 LZ4E	A154		1,6	
	2.9 VR6, Syncro LPG	ABV	140/190	08.1995	08.1997	RFC 52 LZ4E	A159		1,6	
GOLF III Cabriolet (1E7)	1.6 i	AEK-AFT-AKS	74/101	10.1994	05.1998	RFC 58 LZ3EX	A58	B55	0,9	F54
	1.8 i	AAM	55/75	07.1993	05.1998	RC 52 LZ3EX	A35		0,9	L65

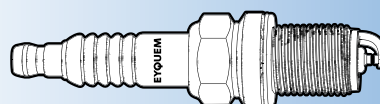

(1) Available until end of stock

- (a) 30 000 km
- (b) 60 000 km
- (c) Grey sticker on ignition coil
- (d) Green sticker on ignition coil

- (e) Hex 21 mm
- (f) Hex 16 mm
- (g) Recommended for cold weather



Box 10
Blister 4



F3-1

VOLKSWAGEN

	1.8 i	ABS-ADZ	66/90	07.1993	05.1998	RC 58 LZ3EX	A34	B54	0,9	L65
	2.0 i	2E-ADY-AGG-AKR	85/115	07.1993	05.1998	RC 58 LZ3EX	A34	B54	0,9	L65
GOLF III Variant (1H5)	1.4 i	ABD	44/60	04.1993	04.1999	RC 58 LZ3EX	A34	B54	0,9	L65
	1.4 i	AEX-APQ	44/60	07.1993	04.1999	RC 52 LZ3EX	A35		0,9	L65
	1.6 i	AFT-AEK-AKS	74/101	07.1994	04.1999	RFC 58 LZ3EX	A58	B55	0,9	F54
	1.8 i	AAM-ANN	55/75	07.1993	04.1999	RC 52 LZ3EX	A35		0,9	L65
	1.8 i	ABS-ADZ-ANP	66/90	07.1993	04.1999	RC 58 LZ3EX	A34	B54	0,9	L65
	1.8 i Syncro	ADZ	66/90	10.1994	04.1999	RC 58 LZ3EX	A34	B54	0,9	L65
	2.0 i	2E-ADY-AGG-AKR	85/115	07.1993	04.1999	RC 58 LZ3EX	A34	B54	0,9	L65
	2.0 i Syncro	AGG	85/115	08.1995	04.1999	RC 58 LZ3EX	A34	B54	0,9	L65
	2.9 VR6, Syncro	ABV	140/190	10.1994	04.1999	RFC 42 LZ4E	A154		1,6	
	2.9 VR6, Syncro LPG	ABV	140/190	10.1994	04.1999	RFC 52 LZ4E	A159		1,6	
GOLF IV (1J1)	1.4 i	APQ	44/60	12.1997	05.1998	RC 58 LZ3EX	A34	B54	0,9	L65
	1.4 16V	AHW-AKQ-APE-AXP-BCA	55/75	08.1997	06.2005	RFC 58 LZ3EX	A58	B55	0,9	F54
	1.6	AEH-AKL-APF	74/101	08.1997	05.2004	RFC 58 LZ3EX	A58	B55	0,9	F54
	1.6	AFT	74/101	06.1998		RFC 58 LZ3EX	A58	B55	0,9	F54
	1.6	AVU-BFQ	75/102	08.2000	06.2005	RFC 58 LZ3EX	A58	B55	0,9	F54
	1.6 16V	ATN-AUS	77/105	11.1999	06.2005	RFC 58 LZ3EX	A58	B55	0,9	F54
	1.6 16V	AZD-BCB	77/105	02.2000	06.2005	RFN 52 LZDPF5	A153		1,0	
	1.8	ADD	66/90	09.1997		RC 58 LZ3EX	A34	B54	0,9	L65
	1.8	AGN-BAF	92/125	08.1997	06.2005	RFC 58 LZ3EX	A58	B55	0,9	F54
	1.8 4motion	AGN	92/125	05.1998	06.2005	RFC 58 LZ3EX	A58	B55	0,9	F54
	1.8 T 20V	AGU-AUR-AMZ-AWD-AQA	110/150	09.1997	06.2005	FN 58 LZDPR	A198		0,75	
	1.8 GTI	AUQ	132/180	08.2001	06.2005	FN 58 LZDPR	A198		0,75	
	2.0	APK-AQY	85/115	07.1998	05.2004	RFC 58 LZ3EX	A58	B55	0,9	F54
	2.0	AZJ-AZG	85/115	07.1998	05.2004	RFN 52 LZDPF5	A153		1,0	
	2.0 Bi-Fuel	BEH	85/115	02.2002	06.2005	RFN 52 LZDPF5	A153		1,0	
	2.0 4motion	AZH	85/115	10.2000	06.2005	RFC 58 LZ3EX	A58	B55	0,9	F54
	2.0 4motion	AZJ	85/115	10.2000	06.2005	RFN 52 LZDPF5	A153		1,0	
	2.3 i V5, 4motion	AGZ	110/150	08.1997	10.2000	RFC 42 LZ4E	A154		1,6	
	2.3 i V5, 4motion LPG	AGZ	110/150	08.1997	10.2000	RFC 52 LZ4E	A159		1,6	
	2.3 i V5	AQN	125/170	08.1997	06.2005	RFN 52 LZDPF5	A153		1,0	
	2.3 i V5, 4motion	AQN	125/170	10.2000	06.2005	RFN 52 LZDPF5	A153		1,0	
	2.8 i V6, 4motion	AQP	150/204	03.1999	06.2005	RFN 52 LZDPF5	A153		1,0	
GOLF IV Cabriolet (1E7)	1.6	AFT	74/100	06.1998	06.2002	RFC 58 LZ3EX	A58	B55	0,9	F54
	1.8 i	AAM-ANN	55/75	06.1998	06.2002	RC 52 LZ3EX	A35		0,9	L65
	1.8 i	ANP-ADZ	66/90	06.1998	06.2002	RC 58 LZ3EX	A34	B54	0,9	L65
	1.8 i	AGG-AKR	85/115	06.1998	06.2002	RC 58 LZ3EX	A34	B54	0,9	L65
	1.8 i	ATU-AWF-AWG	85/115	09.1999	06.2002	FN 58 LZDPR	A198		0,75	
GOLF IV Variant (1J5)	1.4 16V	AHW-AKQ-APE-AXP-BCA	55/75	05.1999	06.2006	RFC 58 LZ3EX	A58	B55	0,9	F54
	1.6	AEH-AKL-APF	74/101	05.1999	04.2002	RFC 58 LZ3EX	A58	B55	0,9	F54
	1.6	AVU-BFQ	75/102	08.2000	06.2006	RFC 58 LZ3EX	A58	B55	0,9	F54
	1.6 16V	ATN-AUS	77/105	02.2000	06.2006	RFC 58 LZ3EX	A58	B55	0,9	F54
	1.6 16V	AZD-BCB	77/105	02.2000	06.2006	RFC 58 LZ3EX	A58	B55	0,9	F54
	1.8 4motion	AGN	92/125	05.1999	06.2006	RFC 58 LZ3EX	A58	B55	0,9	F54
	1.8 T	AGU-AUR-AMZ-AWD-AQA	110/150	09.1997	06.2005	FN 58 LZDPR	A198		0,75	
	2.0	APK-AQY	85/115	05.1999	06.2006	RFC 58 LZ3EX	A58	B55	0,9	F54
	2.0	AZJ	85/115	05.1999	06.2006	RFN 52 LZDPF5	A153		1,0	
	2.0 4motion	AZH	85/115	10.2000	06.2006	RFC 58 LZ3EX	A58	B55	0,9	F54
	2.0 4motion	AZJ	85/115	10.2000	06.2006	RFN 52 LZDPF5	A153		1,0	
	2.0 Bi-Fuel	BEH	85/115	02.2002	06.2006	RFN 52 LZDPF5	A153		1,0	
	2.3 i V5, 4motion	AGZ	110/150	05.1999	06.2006	RFC 42 LZ4E	A154		1,6	
	2.3 i V5, 4motion LPG	AGZ	110/150	05.1999	06.2006	RFC 52 LZ4E	A159		1,6	
	2.3 i V5, 4motion	AQN	125/170	10.2000	06.2006	RFN 52 LZDPF5	A153	1,0		
	2.8 i V6, 4motion	AQP	150/204	05.1999	06.2006	RFN 52 LZDPF5	A153		1,0	
GOLF V (1K1)	1.4 16V	BCA	55/75	10.2003	05.2006	RFC 58 LZ3EX	A58	B55	0,9	F54
	1.4 16V	BUD	59/80	05.2006	11.2008	FN 58 LZKFR5	A521		1,05	
	1.4 TSI	CAXA	90/122	05.2007	11.2008	FC 62 LSDPR	A522		0,9	
	1.4 TSI	BMY (OE: 101 905 626)	103/140	05.2006	11.2008	FC 62 LSDPR	A522		0,9	
NEW	1.4 TSI	BMY (OE: 03C 905 601B)	103/140	05.2006	11.2008	FN 72 LZIPFRS	A551		0,7	
	1.4 TSI	BLG	125/170	11.2005	11.2008	FC 62 LSDPR	A522		0,9	
	1.6	BGU-BSE-BSF	75/102	01.2004	11.2008	RFC 58 LZ3EX	A58	B55	0,9	F54
	2.0	CBPA-BHY	85/116	06.2006	11.2008	RFC 58 LZ3EX	A58	B55	0,9	F54
	2.0 FSI	BLY-BVZ	110/150	01.2004	11.2008	RFN 58 LZDP5	A187		1,1	
	2.0 FSI, 4motion	AXW-BLX-BLR-BVY-BVX	110/150	01.2004	11.2008	FN 62 LZFDPR2A	A192		1,1	

(1) Available until end of stock

(a) 30 000 km

(b) 60 000 km

(c) Grey sticker on ignition coil

(d) Green sticker on ignition coil

(e) Hex 21 mm

(f) Hex 16 mm

(g) Recommended for cold weather



EYQUEM



Box
10

Blister
4



F3 → 1

VOLKSWAGEN

	2.0 GTI	AXX-BPY-BWA-CAWB-CBFA-CCTA	147/200	10.2004	02.2009	FN 68 LZDPR	A523		0,7
	2.0 GTI	BYD	169/230	09.2006	12.2008	FN 68 LZDPR	A523		0,7
GOLF V Variant (1K5)	1.4	BUD	59/80	06.2007	07.2009	FN 58 LZKFR5	A521		1,05
	NEW 1.4 TSI	CAXA	90/122	06.2007	07.2009	FN 72 LZIPFRS	A551		0,7
	NEW 1.4 TSI	CAVD	118/160	07.2008	07.2009	FN 72 LZIPFRS	A551		0,7
	1.4 TSI	BLG	127/170	06.2007	07.2009	FC 62 LSDPR	A522		0,9
	1.6	BSE-BSF-CCSA	75/102	06.2007	07.2009	RFC 58 LZ3EX	A58	B55	0,9 F54
	2.0	BWA-CAWB-CCTA	147/200	06.2007	02.2009	FN 68 LZDPR	A523		0,7
GOLF VI (5K1)	NEW 1.2 TSI	CBZA	63/86	05.2010	11.2012	FN 68 LZIPFRS	A548		0,7
	NEW 1.2 TSI	CBZB	77/105	11.2008	11.2012	FN 68 LZIPFRS	A548		0,7
	1.4	CGGA	59/80	10.2008	11.2012	FN 58 LZKFR5	A521		1,05
	1.4 TSI	CAXA	90/122	10.2008	11.2012	FC 62 LSDPR	A522		0,9
	NEW 1.4 TSI	CAVD/CNWA/CTHD	118/160	10.2008	11.2012	FN 72 LZIPFRS	A551		0,7
	1.6	BSE/BSF/CCSA/CMXA	75/102	10.2008	11.2012	RFC 58 LZ3EX	A58	B55	0,9 F54
	1.6 BiFuel	CHGA	75/102	03.2009	11.2012	RFC 58 LZ3EX	A58	B55	0,9 F54
	1.6 MultiFuel	CCSA/CMXA	75/102	10.2008	11.2012	RFC 58 LZ3EX	A58	B55	0,9 F54
	1.8 TSI	CDA	118/160	06.2009	01.2011	FN 68 LZDPR	A523		0,7
	2.0 GTI	CBFA/CCTA	147/200	06.2009		FN 68 LZDPR	A523		0,7
	2.0 GTI	CCZB	155/211	04.2009	11.2012	FN 68 LZDPR	A523		0,7
	2.0 GTI	CDLG	173/235	05.2011	11.2012	FN 68 LZDPR	A523		0,7
	2.0 R 4motion	CDLC-CRZA	188/256	11.2009	11.2013	FN 68 LZDPR	A523		0,7
	2.0 R 4motion	CDLA	195/265	11.2009	05.2011	FN 68 LZDPR	A523		0,7
	2.0 R 4motion	CDLF	199/271	11.2009	11.2012	FN 68 LZDPR	A523		0,7
	2.5 FSI	CBUA/CBTA	125/170	08.2009		FN 58 LZKFR	A183		0,9
GOLF VI Variant (AJ5)	NEW 1.2 TSI	CBZA	63/86	07.2010	07.2013	FN 68 LZIPFRS	A548		0,7
	NEW 1.2 TSI	CBZB	77/105	07.2009	07.2013	FN 68 LZIPFRS	A548		0,7
	1.4	BUD	59/80	07.2009	07.2013	FN 58 LZKFR	A183		0,9
	1.4	CGGA	59/80	07.2009	07.2013	FN 58 LZKFR5	A521		1,05
	1.4 TSI	CAXA	90/122	07.2009	07.2013	FC 62 LSDPR	A522		0,9
	NEW 1.4 TSI	CAVD/CNWA/CTHD	118/160	07.2009	07.2013	FN 72 LZIPFRS	A551		0,7
	1.6	BSE-BSF-CCSA-CMXA	75/102	07.2009	07.2013	RFC 58 LZ3EX	A58	B55	0,9 F54
	1.6 MultiFuel	CMXA	75/102	07.2010	07.2013	RFC 58 LZ3EX	A58	B55	0,9 F54
	2.0 TSI	CCZA	147/200	07.2009	07.2013	FN 68 LZDPR	A523		0,7
GOLF VI cabriolet (517)	NEW 1.2 TSI	CBZB	77/105	03.2011		FN 68 LZIPFRS	A548		0,7
	NEW 1.2 TSI 16V	CYVD	77/105	11.2013		ZN 62 LSDPFRSO	A538		0,75
	NEW 1.2 TSI 16V	CYVD	77/105	05.2015		ZN 62 LSDPFRSO	A538		0,75
	1.4 TSI	CAXA	90/122	11.2011		FC 62 LSDPR	A522		0,9
	NEW 1.4 TSI	CZCA	92/125	11.2013		ZN 62 LSDPFRSO	A538		0,75
	NEW 1.4 TSI	CZDA	110/150	11.2013		ZN 62 LSDPFRSO	A538		0,75
	NEW 1.4 TSI	CAVD/CNWA/CTHD	118/160	03.2011		FN 72 LZIPFRS	A551		0,7
	2.0 GTI	CCZB	155/211	11.2011		FN 68 LZDPR	A523		0,7
	NEW 2.0 TSI	CULC	162/220	11.2013		FN 72 HZIPRSO	A537		0,75
	2.0 R	CDLA	195/265	01.2013		FN 68 LZDPR	A523		0,7
GOLF VII (5G1, BQ1, BE1, BE2)	NEW 1.0 TSI	CHZK	63/86	01.2017		ZN 62 LSDPFRSO	A538		0,75
	NEW 1.0 TSI	CHZC	81/110	11.2016		ZN 62 LSDPFRSO	A538		0,75
	NEW 1.2 TSI	CJZB/CYVA	63/86	08.2012		ZN 62 LSDPFRSO	A538		0,75
	NEW 1.2 TSI	CJZA	77/105	11.2012		ZN 62 LSDPFRSO	A538		0,75
	NEW 1.2 TSI	CYVB	81/110	04.2014		ZN 62 LSDPFRSO	A538		0,75
	NEW 1.4 TGI CNG	CPWA	81/110	06.2013		ZN 62 LSDPFRSO	A538		0,75
	NEW 1.4 TSI	CMBA/CXSA/CPVA	90/122	11.2012		ZN 62 LSDPFRSO	A538		0,75
	NEW 1.4 TSI MultiFuel	CPVA	90/122	04.2013		ZN 62 LSDPFRSO	A538		0,75
	NEW 1.4 TSI MultiFuel	CPVB	92/125	12.2013		ZN 62 LSDPFRSO	A538		0,75
	NEW 1.4 TSI	CZCA	92/125	05.2014		ZN 62 LSDPFRSO	A538		0,75
	NEW 1.4 TSI	CHPA/CPTA	103/140	11.2012		ZN 62 LSDPFRSO	A538		0,75
	NEW 1.4 TSI	CZDA/CZEA	110/150	05.2014		ZN 62 LSDPFRSO	A538		0,75
	NEW 1.4 GTE Hybrid	CUKB	110/150	05.2014		ZN 62 LSDPFRSO	A538		0,75
	NEW 2.0 GTI	CHHB/CXDA	162/220	04.2013		FN 72 HZIPRSO	A537		0,75
	NEW 2.0 GTI	CHHA	169/230	04.2013		FN 72 HZIPRSO	A537		0,75
	NEW 2.0 GTI Clubsport	CJXE	195/265	02.2016		FN 72 HZIPRSO	A537		0,75
	NEW 2.0 R 4motion	CJXB	206/280	11.2013		FN 72 HZIPRSO	A537		0,75
	NEW 2.0 R 4motion	CJXC	221/300	11.2013		FN 72 HZIPRSO	A537		0,75

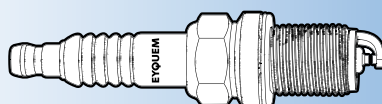

(1) Available until end of stock

- (a) 30 000 km
- (b) 60 000 km
- (c) Grey sticker on ignition coil
- (d) Green sticker on ignition coil

- (e) Hex 21 mm
- (f) Hex 16 mm
- (g) Recommended for cold weather



kW/HP



Box
10

Blister
4



F3-D1

VOLKSWAGEN

GOLF VII break (BA5, BV5)	NEW 1.0 TSI	CHZK	63/86	01.2017		ZN 62 LSDPFRSO	A538		0,75	
	NEW 1.0 TSI	CHZC	81/110	01.2017		ZN 62 LSDPFRSO	A538		0,75	
	NEW 1.2 TSI	CJZB	63/86	05.2013		ZN 62 LSDPFRSO	A538		0,75	
	NEW 1.2 TSI	CJZA	77/105	05.2013		ZN 62 LSDPFRSO	A538		0,75	
	NEW 1.2 TSI	CYVB	81/110	04.2014		ZN 62 LSDPFRSO	A538		0,75	
	NEW 1.4 TGI CNG	CPWA	81/110	09.2013		ZN 62 LSDPFRSO	A538		0,75	
	NEW 1.4 TSI	CXSA	90/122	05.2013		ZN 62 LSDPFRSO	A538		0,75	
	NEW 1.4 TSI MultiFuel	CPVA	90/122	04.2013		ZN 62 LSDPFRSO	A538		0,75	
	NEW 1.4 TSI MultiFuel	CPVB	92/125	05.2014		ZN 62 LSDPFRSO	A538		0,75	
	NEW 1.4 TSI	CZCA/CPVB	92/125	05.2014		ZN 62 LSDPFRSO	A538		0,75	
	NEW 1.4 TSI	CHPA	103/140	05.2013		ZN 62 LSDPFRSO	A538		0,75	
	NEW 1.4 TSI	CZDA	110/150	05.2014		ZN 62 LSDPFRSO	A538		0,75	
	NEW 2.0 R 4motion	CJXB	206/280	03.2015		FN 72 HZIPRSO	A537		0,75	
	NEW 2.0 R 4motion	CJXC	221/300	03.2015		FN 72 HZIPRSO	A537		0,75	
GOLF ALLTRACK (BA5)	NEW 1.8 TSI 4motion	CJSB	132/180	12.2014		FN 72 HZIPRSO	A537		0,75	
GOLF PLUS (5M1, 521)	1.4 16V	BCA	55/75	01.2005	11.2006	RFC 58 LZ3EX	A58	B55	0,9	F54
	1.4 16V	BUD/CGGA	59/80	05.2006	12.2013	FN 58 LZKFR5	A521		1,05	
	NEW 1.2 TSI	CBZB	77/105	11.2009	12.2013	FN 68 LZIPFRS	A548		0,7	
	1.4 TSI	CAXA	90/122	06.2007	12.2013	FC 62 LSDPR	A522		0,9	
	1.4 TSI	BMV	103/140	05.2006	06.2008	FC 62 LSDPR	A522		0,9	
	NEW 1.4 TSI	CAVD	118/160	06.2008	12.2013	FN 72 LZIPFRS	A551		0,7	
	1.4 TSI	BLG	125/170	05.2006	06.2008	FC 62 LSDPR	A522		0,9	
	1.6	BSE/BSF/CCSA	75/102	05.2005	12.2013	RFC 58 LZ3EX	A58	B55	0,9	F54
	1.6 MultiFuel	CCSA/CMXA	75/102	11.2007	12.2013	RFC 58 LZ3EX	A58	B55	0,9	F54
	1.6 BiFuel	CHGA	75/102	05.2009	12.2013	RFC 58 LZ3EX	A58	B55	0,9	F54
	2.0 FSI	BLY-BVZ	110/150	05.2005	06.2008	RFN 58 LZDP5	A187		1,1	
	2.0 FSI LPG	BLY-BVZ	110/150	05.2005	06.2008	RFN 62 LZDP5	A185		0,7	
GOLF PLUS	2.0 FSI	BLR-BVY	110/150	05.2005	06.2008	FN 62 LZDFPR2A	A192		1,1	
GOLF SPORTSVAN (AM1)	NEW 1.2 TSI	CYVA	63/86	05.2014		ZN 62 LSDPFRSO	A538		0,75	
	NEW 1.2 TSI	CYVB	81/110	04.2014		ZN 62 LSDPFRSO	A538		0,75	
	NEW 1.4 TSI	CZCA	92/125	04.2014		ZN 62 LSDPFRSO	A538		0,75	
	NEW 1.4 TSI MultiFuel	CPVB	92/125	04.2014		ZN 62 LSDPFRSO	A538		0,75	
	NEW 1.4 TSI	CZDA	110/150	02.2014		ZN 62 LSDPFRSO	A538		0,75	
ILTIS (183)	1.7	WL-YX	55/75	03.1979	12.1988	C 62 LS	A4	B5	0,7	L65
JETTA I (16)	1.1	GG-FA	37/50	08.1979	07.1984	C 62 LS	A4	B5	0,7	L65
	1.3	GF	44/60	08.1979	07.1984	C 62 LS	A4	B5	0,7	L65
	1.3	HK	40/54	08.1983	07.1986	C 62 LS	A4	B5	0,7	L65
	1.5	JB	51/69	08.1977	07.1984	C 52 LS	A1	B1	0,7	L65
	1.6	FR	63/86	08.1975	07.1984	C 62 LS	A4	B5	0,7	L65
	1.6	EZ	51-53/69-72	08.1983	12.1992	C 52 LS (c)	A1	B1	0,7	L65
	1.6	EW	55/75	08.1982	07.1983	C 52 LS 3X	A28	B25	0,9	L65
	1.6 i GLi, GTI	EG	81/110	06.1976	07.1982	C 82 LS	A40	B6	0,7	L87
	1.6 i GLi, GTI	EG	81/110	06.1976	07.1982	C 82 LS 3X	A92		0,7	L87
	1.8	DX	82/112	08.1982	02.1984	C 62 LS3X (d)	A13	B15	0,8	L65
JETTA II (19E, 1G2, 165)	1.3	MH	40/54	08.1985	12.1988	C 62 LS (c)	A4	B5	0,8	L65
	1.3	HK	40/54	08.1985	12.1988	RC 72 LS	A32	B26	0,7	L65
	1.3 CAT	MH-NZ-2G	40/54	06.1987	12.1991	C 62 LS (c)	A4	B5	0,8	L65
	1.3	GT	44/60	08.1983	07.1987	C 62 LS	A4	B5	0,7	L65
	1.6	PN	51/69	08.1986	07.1992	RC 52 LZ3EX	A35		0,9	L65
	1.6	RF	53/72	02.1986	10.1991	C 52 LS	A1	B1	0,7	L65
	1.6	RF	53/72	02.1986	10.1991	C 52 LS3X	A28	B25	0,9	L65
	1.6	EZ-HM-ABN	51-53/69-72	08.1983	12.1992	C 52 LS3X (d)	A28	B25	0,9	L65
	1.6	HM - HN	55/75	08.1983	07.1988	C 52 LS3X	A28	B25	0,9	L65
	1.8 i	RH	62/84	08.1986	07.1987	C 62 LS3X (d)	A13	B15	0,8	L65
	1.8 i	RH	62/84	08.1987	07.1989	C 62 LS	A4	B5	0,7	L65
	1.8 i	RH	62/84	08.1989	01.1990	C 62 LS3X (d)	A13	B15	0,8	L65
	1.8 i	HV-GU	66/90	08.1982	10.1991	C 62 LS3X	A13	B15	0,8	L65
	1.8 i	GX	66/90	01.1984	07.1988	RC 58 LZ3EX	A34	B54	0,9	L65
	1.8 CAT	GX-RP	66/90	07.1987	10.1991	RC 58 LZ3EX	A34	B54	0,9	L65
	1.8 Syncro	RP-GU	66/90	08.1987	12.1988	RC 58 LZ3EX	A34	B54	0,9	L65
	1.8 Syncro	1P	72/98	08.1988	07.1991	RC 58 LZ3EX	A13	B15	0,8	L65
	1.8 i	RD	79/107	08.1985	07.1988	RC 58 LZ3EX	A34	B54	0,9	L65

(1) Available until end of stock

(a) 30 000 km

(b) 60 000 km

(c) Grey sticker on ignition coil

(d) Green sticker on ignition coil

(e) Hex 21 mm

(f) Hex 16 mm

(g) Recommended for cold weather

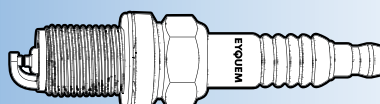

EYQUEM



Box
10

Blister
4



F3 → 1

VOLKSWAGEN

	1.8 CAT	PF	79/107	01.1987	10.1991	C 62 LS (c)	A4	B5	0,7	L65
	1.8 CAT	PF	79/107	01.1987	10.1991	C 62 LS3X (d)	A13	B15	0,8	L65
	1.8 i	DX	82/112	08.1982	07.1984	C 62 LS3X	A13	B15	0,8	L65
	1.8 i	EV-GZ	82/112	01.1984	10.1991	C 62 LS3X (d)	A13	B15	0,8	L65
	1.8 i	PB	82/112	01.1984	10.1991	C 62 LS (c)	A4	B5	0,7	L65
	1.8 i 16V	PL	95/129	02.1986	10.1991	RFC 62 LZ3EX	A86		0,9	F86
	1.8 i 16V	KR	100-102/136-140	08.1985	07.1992	FC 62 LS3X	A57		0,9	F86
	1.8 i 16V	KR	100-102/136-140	08.1985	07.1992	RFC 62 LS3X	A59		0,9	F86
JETTA III (1K2)	1.4 TSI	CAXA	90/122	05.2007	10.2010	FC 62 LSDPR	A522		0,9	
	1.4 TSI	BMY	103/140	07.2006	10.2010	FC 62 LSDPR	A522		0,9	
NEW	1.4 TSI	CAVD	118/160	07.2008	10.2010	FN 72 LZPFRS	A551		0,7	
	1.4 TSI	BLG	125/170	07.2006	10.2010	FC 62 LSDPR	A522		0,9	
	1.6	BSE/BSF/CCSA	75/102	10.2005	10.2010	RFC 58 LZ3EX	A58	B55	0,9	F54
	1.6 MultiFuel	CCSA	75/102	01.2008	10.2010	RFC 58 LZ3EX	A58	B55	0,9	F54
	2.0 FSI	BLY-BLR-BVY	110/150	08.2005	10.2010	FN 62 LZDFPR2A	A192		1,1	
	2.0 FSI	BVZ	110/150	08.2005	10.2010	RFN 58 LZDP5	A187		1,1	
	2.0 TFSI	CAWA	125/170	03.2008	10.2010	FN 68 LZDPR	A523	0,7		
	2.0 TFSI	AXX/BPY/BWA/CAWB/ CBFA/CCTA/CCZA	147/200	10.2005	10.2010	FN 68 LZDPR	A523		0,7	
	2.5 FSI	BTK/BGP	110/150	01.2006	10.2010	RFN 52 LZDPF5	A153		1,0	
JETTA IV (162, 163)	NEW 1.2 TSI	CBZB	77/105	10.2010		FN 68 LZPFRS	A548		0,7	
	NEW 1.2 TSI	CYVD	77/105	08.2014		ZN 62 LSDPFRSO	A538		0,75	
	1.4 TSI	CAXA/CMSB	90/122	05.2011		FC 62 LSDPR	A522		0,9	
	NEW 1.4 TSI	CZCA	92/125	08.2014		ZN 62 LSDPFRSO	A538		0,75	
	NEW 1.4 TSI	CAVA/CTHA	110/150	04.2011	07.2014	FN 72 LZPFRS	A551		0,7	
	NEW 1.4 TSI	CZDA	110/150	08.2014		ZN 62 LSDPFRSO	A538		0,75	
	NEW 1.4 TSI Hybrid	CNLA/CRJA	110/150	04.2011		ZN 62 LSDPFRSO	A538		0,75	
	NEW 1.4 TSI	CAVD/CTHD	118/160	04.2001		FN 72 LZPFRS	A551		0,7	
	1.6	CFNA/CLRA	77/105	12.2011		FN 58 LZKFR5	A521		1,05	
	2.0	CBPA	85/115	06.2010		FN 58 LZKFR5	A521		1,05	
		Fgst.Nr. 16-B-000 001 -->								
	2.0	CKJA	85/115	06.2010		FN 58 LZKFR	A183		0,9	
	2.0 TSI	CBFA/CCTA/CCZA	147/200	12.2010		FN 68 LZDPR	A523		0,7	
	2.5 FSI	CCCA	125/170	04.2010		FN 58 LZKFR5	A521		1,05	
	NEW 2.5 FSI	CBTA	125/170	04.2010		RFN 52 LZDPF5	A153		1,0	
K 70 (48)	1.6	DB	55/75	08.1970	07.1971	C 62 LS	A4	B5	0,7	L65
	1.6	DA	66/90	08.1970	10.1974	C 62 LS	A4	B5	0,7	L65
	1.8	DC	74/101	08.1973	10.1974	C 62 LS	A4	B5	0,7	L65
KAEFER / BEETLE / COCCINELLE	1.6	ACD	34/46	01.1993		C 52 LS	A1	B1	0,7	L65
	1200 : 1.2	AB-AR-D				C 32	A33		0,6	
	1303 : 1.6	AD-AF-AJ-AS				C 32	A33		0,6	
LOAD UP	NEW 1.0 EcoFuel	CPGA	50/68	12.2014		ZN 62 LSDPFRSO	A538		0,75	
LT 28-35 I Bus (281-363)	2.0	CL-CH	51-55/69-75	04.1975	09.1983	RC 72 LS	A32	B26	0,7	L87
	2.4	HS-DL	62-64/84-90	12.1982	07.1992	C 62 LS	A4	B5	0,7	L65
	2.4 i	1E	70/95	10.1988	12.1990	C 62 LS	A4	B5	0,7	L65
	2.4 i	1E	70/95	01.1991	07.1995	C 52 LS3X	A28	B25	0,9	L65
	2.4 i	1E	70/95	08.1995	06.1996	RC 52 LZ3EX	A35		0,9	L65
LT 28-35 I Camionnette (281-363)	2.0	CH	55/75	04.1975	09.1983	RC 72 LS	A32	B26	0,7	L87
	2.4	DL	66/90	12.1982	07.1992	C 62 LS	A4	B5	0,7	L65
	2.4 i	1E	70/95	10.1988	12.1990	C 62 LS	A4	B5	0,7	L65
	2.4 i	1E	70/95	01.1991	07.1995	C 52 LS3X	A28	B25	0,9	L65
	2.4 i	1E	70/95	08.1995	06.1996	RC 52 LZ3EX	A35		0,9	L65
LT 28-35 I Platform/ Chassis (281-363)	2.0	CH	55/75	04.1975	09.1983	RC 72 LS	A32	B26	0,7	L87
	2.4, Syncro	DL	66/90	12.1982	07.1992	C 62 LS	A4	B5	0,7	L65
	2.4 i	1E	70/95	03.1994	07.1995	C 52 LS3X	A28	B25	0,9	L65
	2.4 i	1E	70/95	08.1995	07.1996	RC 52 LZ3EX	A35		0,9	L65
	2.4 i	1E	70/95	08.1992	07.1994	RC 52 LS	A9	B20	0,8	L65
LT 40-55 I Camionnette (291-512)	2.0	CH	55/75	04.1975	09.1983	RC 72 LS	A32	B26	0,7	L87
	2.4, Syncro	DL	66/90	12.1982	07.1992	C 62 LS	A4	B5	0,7	L65



- (1) Available until end of stock
 (a) 30 000 km
 (b) 60 000 km
 (c) Grey sticker on ignition coil
 (d) Green sticker on ignition coil

- (e) Hex 21 mm
 (f) Hex 16 mm
 (g) Recommended for cold weather



Box
10 Blister
4



F3-D1

VOLKSWAGEN

	2.4 i	1E	70/95	01.1993	07.1995	C 52 LS3X	A28	B25	0,9	L65
	2.4 i	1E	70/95	08.1995	07.1996	RC 52 LZ3EX	A35		0,9	L65
LT 40-55 I Platform/ Chassis (293-909)	2.0	CH	55/75	04.1975	09.1983	RC 72 LS	A32	B26	0,7	L87
	2.4 i	1E	70/95	03.1994	07.1995	C 52 LS3X	A28	B25	0,9	L65
	2.4 i	1E	70/95	08.1995	07.1996	RC 52 LZ3EX	A35		0,9	L65
LT 28-35 II Bus (2DB, 2DE, 2DK)	2.3 i	AGL	105/143	05.1996	07.2006	RFC 58 LZ2E	A10	B31	0,9	F54
LT 28-46 II Box (2DA, 2DD, 2DH)	2.3 i	AGL	105/143	05.1996	07.2006	RFC 58 LZ2E	A10	B31	0,9	F54
LT 28-46 II Platform/ Chassis (2DC, 2DF, 2DG, 2DL, 2DM)	2.3 i	AGL	105/143	05.1996	07.2006	RFC 58 LZ2E	A10	B31	0,9	F54
LUPO (6X1, 6E1)	1.0	AHT	37/50	10.1998	05.2000	FN 58 LZDPR	A198		0,75	
	1.0	AER-ALL	37/50	09.1998	07.2005	RC 58 LZ3EX	A34	B54	0,9	L65
	1.0	ALD-ANV-AUC	37/50	04.1998	07.2005	RFN 52 LZDPF5	A153		1,0	
	1.4	AUD	44/60	10.2000	07.2005	RFN 52 LZDPF5	A153		1,0	
	1.4 16V	AHW-AKQ-APE-AUA-BBY	55/75	09.1998	07.2005	RFC 58 LZ3EX	A58	B55	0,9	F54
	1.4 16V	AFK/ANM/AQ/AUB	74/101	08.1999	07.2005	RFC 58 LZ3EX	A58	B55	0,9	F54
	1.6 i 16V	AJV	88/120	08.1998		RFC 58 LZ3EX	A58	B55	0,9	F54
	1.6 GTI	AVY	92/125	09.2000	07.2005	RFC 58 LZ3EX	A58	B55	0,9	F54
MULTIVAN	1.8	PD	48-49/65-67	12.1990	07.1992	C 62 LS3X	A13	B15	0,8	L65
	2.0	AXA	85/115	04.2003		RFC 58 LZ3EX	A58	B55	0,9	F54
	2.0 i, T4	AAC	62-64/84-87	09.1990		RC 52 LZ3EX	A35		0,9	L65
	2.5 i, Synchro	AAF - ACU	81/110	11.1990	08.1996	RC 52 LZ3EX	A35		0,9	L65
	2.5 i, T4	AAF - ACU - AEN	81/110	11.1990	08.1996	RC 52 LZ3EX	A35		0,9	L65
	2.5 i, T4	AET - AEU	81/110	08.1996		RC 52 LZ3EX	A35		0,9	L65
	2.8 VR6, T4	AES	103/140	11.1995	04.2000	RFC 42 LZ4E	A154		1,6	
MULTIVAN V (7HM, 7HN, 7HF, 7EF, 7EM, 7EN)	2.0	AXA	85/115	11.2003		RFC 58 LZ3EX	A58	B55	0,9	F54
	2.0 TSI	CJKB	110/150	07.2012		FN 68 LZDPR	A523		0,7	
	2.0 TSI, 4motion	CJKA	150/204	05.2011		FN 68 LZDPR	A523		0,7	
MULTIVAN VI (SGF, SGM, SGN)	2.0 TSI	CJKB	110/150	04.2015		FN 68 LZDPR	A523		0,7	
	2.0 TSI, 4motion	CJKA	150/204	04.2015		FN 68 LZDPR	A523		0,7	
NEW BEETLE (9C1, 1C1)	1.4	BCA	55/75	11.2001	09.2010	RFN 52 LZDPF5	A153		1,1	
	1.6	AWH	74/101	10.1999	09.2000	RFC 58 LZ3EX	A58	B55	0,9	F54
	1.6	AYD	75/102	09.2000	07.2001	RFN 52 LZDPF5	A153		1,1	
	1.6	AYD-BFS	75/102	08.2001	09.2010	RFC 58 LZ3EX	A58	B55	0,9	F54
	1.8 T	APH/AVC/AWU/AWW/BKF	110/150	01.2003	09.2010	FN 58 LZDPR	A198		0,75	
	1.8 T	AWP/BNU	132/180	11.2001	06.2005	FN 58 LZDPR	A198		0,75	
	2.0	AEG/APK/AQY/BHP/CPBA/BEJ	85/115	01.1998	09.2010	RFC 58 LZ3EX	A58	B55	0,9	F54
	2.0	AZJ/AZG/BER/BEV/AVH	85/115	01.1998	09.2010	RFN 52 LZDPF5	A153		1,1	
	2.3 V5	AQN	125/170	10.2000	09.2010	RFN 52 LZDPF5	A153		1,1	
	2.5	BPS/BPR	110/150	07.2005	09.2010	FN 58 LZKFR5	A521		1,05	
	3.2 RSI	AXJ	165/225	04.2000	05.2001	RFN 52 LZDPF5	A153		1,1	
NEW BEETLE Cabriolet (1Y7)	1.4	BCA	55/75	01.2003	09.2010	RFN 52 LZDPF5	A153		1,1	
	1.6	BFS	75/102	01.2003	09.2010	RFC 58 LZ3EX	A58	B55	0,9	F54
	1.8 T	AWU/AWW/BKF	110/150	01.2003	09.2010	FN 58 LZDPR	A198		0,75	
	2.0	AZJ//BEV/BDC/BEV/BGD	85/115	09.2002	05.2005	RFN 52 LZDPF5	A153		1,1	
	2.0	AZJ//BEV	85/115	06.2005	10.2010	FN 58 LZKFR	A183		0,9	
	2.5	BPS/BPR	110/150	07.2005	09.2010	FN 58 LZKFR5	A521		1,05	
PASSAT I (32)	1.3	FY-FZ-ZA-ZF	40-44/54-60	05.1972	07.1983	C 62 LS	A4	B5	0,7	L65
	1.5	ZB-YG	55/75	07.1973	12.1975	RC 72 LS	A32	B26	0,7	L87
	1.5	ZC	63/86	05.1973	12.1975	C 82 LS	A40	B6	0,7	L87
	1.6	WP	48/65	08.1979	01.1982	C 62 LS	A4	B5	0,7	L65
	1.6	YP	63/85	08.1975	07.1980	C 62 LS	A4	B5	0,7	L65
	1.6	YU-YT	51/69	09.1975	08.1979	C 62 LS	A4	B5	0,7	L65
	1.6	WV	51-55/69-75	09.1975	07.1983	C 62 LS	A4	B5	0,7	L65
	1.6	WVA-YN-WY-WZ-YP	55-63/75-85	09.1975	07.1983	C 62 LS	A4	B5	0,7	L65
	1.6	YY	51/69	09.1979	07.1981	C 62 LS	A4	B5	0,7	L65
	1.6	YG-YH	63/86	09.1975	07.1980	C 62 LS	A4	B5	0,7	L65

(1) Available until end of stock

(a) 30 000 km

(b) 60 000 km

(c) Grey sticker on ignition coil

(d) Green sticker on ignition coil

(e) Hex 21 mm

(f) Hex 16 mm

(g) Recommended for cold weather

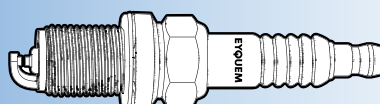

EYQUEM



Box 10
Blister 4



F3 → 1

VOLKSWAGEN

	1.6	YS	81/110	01.1976	07.1980	C 82 LS	A40	B6	0,7	L87
PASSAT I Variant (33)	1.3	FY	40/55	05.1973	07.1980	C 62 LS	A4	B5	0,7	L65
	1.3	ZA	40/55	05.1973	01.1978	C 62 LS	A4	B5	0,7	L65
	1.3	ZF	44/60	10.1973	01.1978	C 62 LS	A4	B5	0,7	L65
	1.5	ZB-YG	55/75	10.1973	08.1975	RC 72 LS	A32	B26	0,7	L87
	1.5	ZC	63/86	10.1973	12.1975	RC 72 LS	A32	B26	0,7	L87
	1.6	YN	55/75	02.1976	07.1980	C 62 LS	A4	B5	0,7	L65
	1.6	YP	63/85	08.1975	07.1980	C 62 LS	A4	B5	0,7	L65
	1.6 i	YS	81/110	06.1978	07.1980	C 82 LS	A40	B6	0,7	L87
PASSAT II (32B)	1.3	FY	40/55	08.1980	07.1983	C 62 LS	A4	B5	0,7	L65
	1.3	FZ	44/60	08.1980	07.1986	C 62 LS	A4	B5	0,7	L65
	1.3	EP-EU	44/60	08.1980	07.1986	C 52 LS3X	A28	B25	0,9	L65
	1.6	PP	51/69	03.1987	08.1988	RC 52 LZ3EX	A35		0,9	L65
	1.6	RL-JU	53-55/72-75	08.1983	04.1988	C 52 LS3X	A28	B25	0,9	L65
	1.6	YN-WV	55/75	08.1980	03.1988	C 62 LS	A4	B5	0,7	L65
	1.6	DT-DTA	51-55/69-75	08.1980	03.1988	C 52 LS3X	A28	B25	0,9	L65
	1.6	YP	63/85	01.1982	02.1983	C 62 LS	A4	B5	0,7	L65
	1.8	RM	64/87	02.1986	03.1988	RC 72 LS	A32	B26	0,7	L87
	1.8	DS-JN	66/90	01.1983	04.1988	C 62 LS3X	A13	B15	0,8	L65
	1.8	JV	66/90	01.1983	04.1988	C 72 LS3X	A63		0,8	L87
	1.8	DZ	82/112	01.1983	07.1984	C 62 LS3X	A13	B15	0,8	L65
	1.9	WN	85/115	10.1980	08.1983	C 82 LS	A40	B6	0,7	L87
	1.9	WN	85/115	10.1980	08.1983	C 82 LS3X	A92		0,8	L87
	2.0	JS-HP	85/115	08.1983	03.1988	C 62 LS3X	A13	B15	0,8	L65
	2.1	WE	85/115	01.1981	07.1983	C 62 LS	A4	B5	0,7	L65
	2.2	KX	85/115	08.1985	03.1988	C 62 LS3X	A13	B15	0,8	L65
	2.2	KV	100/136	08.1984	04.1988	C 72 LS3X	A63		0,8	L87
	2.2 Syncro	HY	100/136	08.1984	04.1988	C 72 LS3X	A63		0,8	L87
PASSAT II A (32B)	1.6	PP	51/69	08.1987	03.1988	RC 52 LZ3EX	A35		0,9	L65
	1.6	RL	53/72	01.1985	03.1988	C 52 LS3X	A28	B25	0,9	L65
	1.6	DT	55/75	01.1985	03.1988	C 52 LS3X	A28	B25	0,9	L65
	1.8	RM	64/87	05.1986	03.1988	RC 72 LS	A32	B26	0,7	L87
	1.8	DS-JN	66/90	01.1985	03.1988	C 62 LS3X	A13	B15	0,8	L65
	2.0	JS-HP	85/115	08.1984	07.1985	C 62 LS3X	A13	B15	0,8	L65
	2.2	KX	85/115	01.1985	03.1988	C 62 LS3X	A13	B15	0,8	L65
PASSAT II Variant (32B)	1.3	FY	40/55	08.1980	07.1983	C 62 LS	A4	B5	0,7	L65
	1.3	FZ	44/60	08.1980	07.1986	C 62 LS	A4	B5	0,7	L65
	1.3	EP-EU	44/60	08.1980	07.1986	C 52 LS3X	A28	B25	0,9	L65
	1.6	PP	51/69	08.1987	03.1988	RC 52 LZ3EX	A35		0,9	L65
	1.6	RL	53/72	01.1985	03.1988	C 52 LS3X	A28	B25	0,9	L65
	1.6	YN-WV	55/75	08.1980	03.1988	C 62 LS	A4	B5	0,7	L65
	1.6	YP	63/85	01.1981	02.1983	C 62 LS	A4	B5	0,7	L65
	1.6	DT	55/75	08.1980	03.1988	C 52 LS3X	A28	B25	0,9	L65
	1.8	RM	64/87	05.1986	03.1988	RC 72 LS	A32	B26	0,7	L87
	1.8	DS-JN	66/90	01.1983	03.1988	C 62 LS3X	A13	B15	0,8	L65
	1.8	JV	66/90	01.1983	04.1988	C 72 LS3X	A63		0,8	L87
	1.8 Syncro	DS-JN	66/90	01.1986	03.1988	C 62 LS3X	A13	B15	0,8	L65
	1.8	DZ	82/112	12.1983	03.1988	C 62 LS3X	A13	B15	0,8	L65
	1.9	WN	85/115	01.1981	07.1983	C 82 LS	A40	B6	0,7	L87
	1.9	WN	85/115	01.1981	07.1983	C 82 LS3X	A92		0,8	L87
	2.0	JS-HP	85/115	08.1983	03.1988	C 62 LS3X	A13	B15	0,8	L65
	2.0 Syncro	JS	85/116	05.1984	03.1988	C 62 LS3X	A13	B15	0,8	L65
	2.2	KX	85/115	08.1985	03.1988	C 62 LS3X	A13	B15	0,8	L65
	2.2 Syncro	JT	88/120	08.1985	03.1988	C 62 LS3X	A13	B15	0,8	L65
	2.2	KV	100/136	08.1985	03.1988	C 72 LS3X	A63		0,8	L87
PASSAT III (3A2, 35I)	1.6	1F	53/72	02.1988	09.1991	RC 52 LZ3EX	A35		0,9	L65
	1.6	EZ	55/75	04.1988	07.1992	C 52 LS (c)	A1	B1	0,7	L65
	1.6	EZ	55/75	04.1988	07.1992	C 52 LS3X (d)	A28	B25	0,9	L65
	1.6	EZ-ABN	55/75	08.1989	07.1992	C 52 LS3X	A28	B25	0,9	L65
	1.6	AFT-AEK	74/101	07.1994	12.1995	RFC 58 LZ3EX	A58	B55	0,9	F54
	1.6 i	AHL	74/101	09.1996		RFC 58 LZ3EX	A58	B55	0,9	F54
	1.8 i	AAM	55/75	08.1990	03.1997	RC 52 LZ3EX	A35		0,9	L65
	1.8 i	RP	66/90	01.1983	07.1991	RC 58 LZ3EX	A34	B54	0,9	L65
	1.8 i	ABS	66/90	08.1991	09.1994	RC 58 LZ3EX	A34	B54	0,9	L65
	1.8 i	ADZ	66/90	07.1994	03.1997	RC 58 LZ3EX	A34	B54	0,9	L65

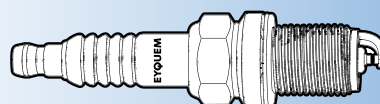

- (1) Available until end of stock
(a) 30 000 km
(b) 60 000 km
(c) Grey sticker on ignition coil
(d) Green sticker on ignition coil

- (e) Hex 21 mm
(f) Hex 16 mm
(g) Recommended for cold weather



Box
10

Blister
4



F3-1

VOLKSWAGEN

	1.8 i	PF	79/107	04.1988	07.1990	C 62 LS (c)	A4	B5	0,7	L65
	1.8 i	PF	79/107	07.1990	07.1993	C 62 LS3X (d)	A13	B15	0,8	L65
	1.8 i	PB	82/112	04.1988	07.1992	C 62 LS (c)	A4	B5	0,7	L65
	1.8 i	PB	82/112	04.1988	07.1992	C 62 LS3X (d)	A13	B15	0,8	L65
	1.8 i 16V	KR	100-102/136-139	04.1988	07.1992	FC 62 LS3X	A57		0,9	F86
	1.8 i 16V	KR	100-102/136-139	04.1988	07.1992	RFC 62 LS3X	A59		0,9	F86
	2.0 i	AEP	79-85/107-115	06.1993	08.1996	RC 58 LZ3EX	A34	B54	0,9	L65
	2.0 i	AAW	81/110	01.1991		C 52 LS3X	A28	B25	0,9	L65
	2.0 i Syncro	ACX	85/115	06.1993	12.1995	RC 58 LZ3EX	A34	B54	0,9	L65
	2.0 i	2E	85/115	02.1990	08.1996	RC 52 LZ3EX	A35		0,9	L65
	2.0 i	ADY-AGG	85/115	02.1990	08.1996	RC 58 LZ3EX	A34	B54	0,9	L65
	2.0 i Syncro	2E	85/115	10.1990	08.1996	RC 52 LZ3EX	A35		0,9	L65
	2.0 i Syncro	ADY-AGG	85/115	10.1990	08.1996	RC 58 LZ3EX	A34	B54	0,9	L65
	2.0 i 16V	9A	100/136	08.1988	09.1993	RFC 62 LZ3EX	A86		0,9	F86
	2.0 i 16V	ABF	110/150	08.1993	03.1997	RFC 58 LZ3EX	A58	B55	0,9	F54
	2.8 VR6	AAA	128/174	01.1985	08.1996	RFC 42 LZ4E	A154		1,6	
	2.8 VR6 LPG	AAA	128/174	01.1985	08.1996	RFC 52 LZ4E	A159		1,6	
PASSAT III Variant (3A5, 35I)	1.6	1F	53/72	04.1988	09.1991	RC 52 LZ3EX	A35		0,9	L65
	1.6	EZ	53/72	04.1988	09.1991	C 52 LS3X	A28	B25	0,9	L65
	1.6	AFT-AEK	74/101	07.1994	12.1995	RFC 58 LZ3EX	A58	B55	0,9	F54
	1.8 i	AAM	55/75	08.1990	05.1997	RC 52 LZ3EX	A35		0,9	L65
	1.8 i	RP-ABS-ADZ	66/90	02.1988	05.1997	RC 58 LZ3EX	A34	B54	0,9	L65
	1.8 i	PF	79/107	04.1988	07.1990	C 62 LS3X (d)	A13	B15	0,8	L65
	1.8 i	PB	82/112	04.1988	07.1992	C 62 LS (c)	A4	B5	0,7	L65
	1.8 i	PB	82/112	04.1988	07.1992	C 62 LS3X (d)	A13	B15	0,8	L65
	1.8 i 16V	KR	100/136	04.1988	12.1989	FC 62 LS3X	A57		0,9	F86
	1.8 i 16V	KR	100/136	04.1988	12.1989	RFC 62 LS3X	A59		0,9	F86
	2.0 i	AEP	79/107	03.1995	08.1996	RC 58 LZ3EX	A34	B54	0,9	L65
	2.0 i	2E	85/115	02.1990	05.1997	RC 52 LZ3EX	A35		0,9	L65
	2.0 i	ADY-AGG	85/115	02.1990	05.1997	RC 58 LZ3EX	A34	B54	0,9	L65
	2.0 i 16V	9A	100/136	08.1988	09.1993	RFC 62 LZ3EX	A86		0,9	F86
	2.0 16V	ABF	110/150	01.1994	05.1997	RFC 58 LZ3EX	A58	B55	0,9	F54
	2.8 VR6	AAA	128/174	06.1991	05.1997	RFC 42 LZ4E	A154		1,6	
	2.8 VR6 LPG	AAA	128/174	06.1991	05.1997	RFC 52 LZ4E	A159		1,6	
	2.9 VR6 Syncro	ABV	135/184	01.1994	05.1997	RFC 42 LZ4E	A154		1,6	
	2.9 VR6 Syncro LPG	ABV	135/184	01.1994	05.1997	RFC 52 LZ4E	A159		1,6	
PASSAT IV (3B2)	1.6 i	AHL/ADP/ANA/ARM	74/101	10.1996	11.2000	RFC 58 LZ3EX	A58	B55	0,9	F54
	1.8 i	AFY	85/115	08.1995	11.2000	RFC 58 LZ3EX	A58	B55	0,9	F54
	1.8, Syncro	ADR/APT/ARG	92/125	10.1996	11.2000	RFC 58 LZ3EX	A58	B55	0,9	F54
	1.8 T	AEB/ANB/APU	110/150	10.1996	11.2000	FN 58 LZDPR	A198		0,75	
	2.0, 4motion	ASU/AUZ	88/120	04.2000	11.2000	RFC 58 LZ3EX	A58	B55	0,9	F54
	2.3 iV5	AGZ	110/150	08.1996	11.2000	RFC 42 LZ4E	A154		1,6	
	2.3 iV5 LPG	AGZ	110/150	08.1996	11.2000	RFC 52 LZ4E	A159		1,6	
	2.3 iV5 Syncro 4motion	AGZ	110/150	10.1997	11.2000	RFC 42 LZ4E	A154		1,6	
	2.3 iV5 Syncro 4motion LPG	AGZ	110/150	10.1997	11.2000	RFC 52 LZ4E	A159		1,6	
	2.8 V6	AGE	132/180	06.1997	11.2000	RFC 58 LZP4	A193		1,5	
	2.8 V6	ATX	140/190	08.1996	11.2000	RFC 58 LZP4	A193		1,5	
	2.8 V6	ACK- AHA-AQD-APR	142/193	08.1996	11.2000	RFC 62 LZ2	A150		1,6	
	2.8 V6 Syncro/4motion	ACK-ALG-APR-AQD-AHA	142/193	10.1996	11.2000	RFC 62 LZ2	A150		1,6	
PASSAT IV Variant (3B5)	1.6	AHL/ANA/ARM/ADP	74/101	06.1997	11.2000	RFC 58 LZ3EX	A58	B55	0,9	F54
	1.8, Syncro/4motion	ADR/APT/ARG	92/125	06.1997	11.2000	RFC 58 LZ3EX	A58	B55	0,9	F54
	1.8 T	AEB/ANB/APU	110/150	06.1997	11.2000	FN 58 LZDPR	A198		0,75	
	2.0, 4motion	ASU/AUZ	88/120	04.2000	11.2000	RFC 58 LZ3EX	A58	B55	0,9	F54
	2.3 iV5	AGZ	110/150	06.1997	11.2000	RFC 42 LZ4E	A154		1,6	
	2.3 iV5 LPG	AGZ	110/150	06.1997	11.2000	RFC 52 LZ4E	A159		1,6	
	2.3 iV5 Syncro 4motion	AGZ	110/150	10.1997	11.2000	RFC 42 LZ4E	A154		1,6	
	2.3 iV5 Syncro 4motion LPG	AGZ	110/150	10.1997	11.2000	RFC 52 LZ4E	A159		1,6	
	2.8 V6, Syncro/4motion	ACK- AHA-AQD-APR	142/193	06.1997	11.2000	RFC 62 LZ2	A150		1,6	
PASSAT V (3B3)	1.6	ALZ	75/102	11.2000	05.2005	RFC 58 LZ3EX	A58	B55	0,9	F54
	1.8 i	APT-ARG	92/125	01.1999		RFC 58 LZ3EX	A58	B55	0,9	F54
	1.8 T 20V	AWT-AWL	110/150	11.2000	05.2005	FN 58 LZDPR	A198		0,75	
	1.8 T 4motion	AWM	125/170	03.2001	05.2005	FN 58 LZDPR	A198		0,75	
	2.0	AZM-BFF	85/115	11.2000	05.2005	RFC 58 LZ3EX	A58	B55	0,9	F54
	2.0 4motion	AZM	85/115	11.2000	05.2005	RFC 58 LZ3EX	A58	B55	0,9	F54

(1) Available until end of stock

(a) 30 000 km

(b) 60 000 km

(c) Grey sticker on ignition coil

(d) Green sticker on ignition coil

(e) Hex 21 mm

(f) Hex 16 mm

(g) Recommended for cold weather

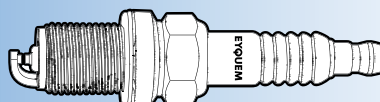

EYQUEM



Box
10

Blister
4



F3 → 1

VOLKSWAGEN

	2.3 V5, 4motion	AZX	125/170	11.2000	05.2005	RFN 52 LZDPF5	A153		1,1	
	2.8 V6 4motion	AMX-ATQ	142/193	11.2000	05.2005	RFC 62 LZ2	A150		1,6	
PASSAT V Variant (3B6)	1.6	ALZ	75/102	11.2000	05.2005	RFC 58 LZ3EX	A58	B55	0,9	F54
	1.8 T 20V	AWT	110/150	11.2000	05.2005	FN 58 LZDPR	A198		0,75	
	2.0, 4motion	AZM	85/115	11.2000	05.2005	RFC 58 LZ3EX	A58	B55	0,9	F54
	2.3 VR5, 4motion	AZX	125/170	11.2000	05.2005	RFN 52 LZDPF5	A153		1,1	
	2.8 V6 4motion	AMX-ATQ	142/193	11.2000	05.2005	RFC 62 LZ2	A150		1,6	
PASSAT VI (3C2)	1.4 TSI	CAXA	90/122	05.2007	07.2010	FC 62 LSDPR	A522		0,9	
	1.6	BSE/BSF	75/102	05.2005	07.2010	RFC 58 LZ3EX	A58	B55	0,9	F54
	1.8 TSI	BZB/CDA	118/160	05.2007	07.2010	FN 68 LZDPR	A523		0,7	
	2.0 FSI	BLY-BVZ	110/150	03.2005	07.2010	RFN 58 LZDP5	A187		1,1	
	2.0 FSI LPG	BLY-BVZ	110/150	03.2005	07.2010	RFN 62 LZDP5	A185		0,7	
	2.0 FSI	BLR-BVY	110/150	03.2005	07.2010	FN 62 LZFDPR2A	A192		1,1	
	2.0 FSI 4motion	BLX-BVX	110/150	09.2005	07.2010	FN 62 LZFDPR2A	A192		1,1	
	2.0 FSI 4motion	BLY	110/150	09.2005	07.2010	RFN 58 LZDP5	A187		1,1	
	2.0 FSI	AXX/BWA/BPY/ CAWB/CCTA/CCZA	147/200	07.2005	07.2010	FN 68 LZDPR	A523		0,7	
PASSAT VI Variant (3C5)	1.4 TSI	CAXA	90/122	05.2007	11.2010	FC 62 LSDPR	A522		0,9	
	1.6	BSE/BSF	75/102	05.2005	11.2010	RFC 58 LZ3EX	A58	B55	0,9	F54
	1.8 TSI	BZB/CDA	118/160	05.2007	10.2011	FN 68 LZDPR	A523		0,7	
	2.0 FSI	BLY-BVZ	110/150	08.2005	11.2010	RFN 58 LZDP5	A187		1,1	
	2.0 FSI LPG	BLY-BVZ	110/150	08.2005	11.2010	RFN 62 LZDP5	A185		0,7	
	2.0 FSI	BLR-BVY	110/150	08.2005	11.2010	FN 62 LZFDPR2A	A192		1,1	
	2.0 FSI 4motion	BLX-BVX	110/150	09.2005	07.2010	FN 62 LZFDPR2A	A192		1,1	
	2.0 FSI 4motion	BLY	110/150	09.2005	07.2010	RFN 58 LZDP5	A187		1,1	
	2.0 FSI	AXX/BWA/BPY/ CAWB/CCTA/CCZA	147/200	07.2005	07.2010	FN 68 LZDPR	A523		0,7	
PASSAT VII (362)	1.4 TSI	CAXA	90/122	08.2010	12.2014	FC 62 LSDPR	A522		0,9	
NEW	1.4 TSI	CTHD	118/160	11.2012	12.2014	FN 72 LZIPFRS	A551		0,7	
	1.8 TSI	CDA	118/160	08.2010	12.2014	FN 68 LZDPR	A523		0,7	
	2.0 TSI	CCZB	155/211	11.2010	12.2014	FN 68 LZDPR	A523		0,7	
PASSAT VII Variant (365)	1.4 TSI	CAXA	90/122	08.2010	11.2010	FC 62 LSDPR	A522		0,9	
NEW	1.4 TSI	CTHD	118/160	11.2012	12.2014	FN 72 LZIPFRS	A551		0,7	
	1.8 TSI	CDA	118/160	08.2010	12.2014	FN 68 LZDPR	A523		0,7	
	2.0 TSI	CCZB	155/210	11.2010	12.2014	FN 68 LZDPR	A523		0,7	
PASSAT VIII (3G2)	NEW 1.4 GTE Hybrid	CUKC	115/156	06.2015		ZN 62 LSDPFRSO	A538		0,75	
NEW	1.4 TSI	CZCA	92/125	11.2014		ZN 62 LSDPFRSO	A538		0,75	
NEW	1.4 TSI	CZEA	110/150	11.2014		ZN 62 LSDPFRSO	A538		0,75	
NEW	1.4 TSI 4motion	CZEA	110/150	02.2015		ZN 62 LSDPFRSO	A538		0,75	
NEW	1.8 TSI	CJSA/CJSC	132/180	02.2015		FN 72 HZIPRSO	A537		0,75	
NEW	2.0 TSI	CHHB	162/220	02.2015		FN 72 HZIPRSO	A537		0,75	
NEW	2.0 TSI 4motion	CJXA	206/280	05.2015		FN 72 HZIPRSO	A537		0,75	
PASSAT VIII VARIANT (3G5)	NEW 1.4 GTE Hybrid	CUKC	115/156	06.2015		ZN 62 LSDPFRSO	A538		0,75	
NEW	1.4 TSI	CZCA	92/125	11.2014		ZN 62 LSDPFRSO	A538		0,75	
NEW	1.4 TSI	CZEA	110/150	11.2014		ZN 62 LSDPFRSO	A538		0,75	
NEW	1.4 TSI 4motion	CZEA	110/150	02.2015		ZN 62 LSDPFRSO	A538		0,75	
NEW	1.8 TSI	CJSA/CJSC	132/180	02.2015		FN 72 HZIPRSO	A537		0,75	
NEW	2.0 TSI	CHHB	162/220	02.2015		FN 72 HZIPRSO	A537		0,75	
NEW	2.0 TSI 4motion	CJXA	206/280	05.2015		FN 72 HZIPRSO	A537		0,75	
PASSAT ALLTRACK (365)	1.8 TSI	CDAB	112/152	01.2012	12.2014	FN 68 LZDPR	A523		0,7	
	1.8 TSI	CDA	118/160	01.2012	12.2014	FN 68 LZDPR	A523		0,7	
	1.8 TSI	CCZB	155/211	01.2012	12.2014	FN 68 LZDPR	A523		0,7	
PASSAT ALLTRACK (3G5)	NEW 1.4 TSI 4motion	CZEA	110/150	05.2015		ZN 62 LSDPFRSO	A538		0,75	
NEW	2.0 TSI 4motion	CHHB	162/220	07.2015		FN 72 HZIPRSO	A537		0,75	
PASSAT CC (357)	1.8 TSI	BZB/CDA	118/160	06.2008	01.2012	FN 68 LZDPR	A523		0,7	
	2.0 TSI	CAWB/CCTA/CBFA/CCZA	147/200	06.2008	01.2012	FN 68 LZDPR	A523		0,7	
	2.0 TSI	CCZB	155/211	11.2010	01.2012	FN 68 LZDPR	A523		0,7	
PHAETON (3D_)	4.2 V8 4motion	BGH/BGJ	246/335	05.2003	03.2016	RFC 52 LZ4E	A159		1,6	
	6.0 W12 4motion	BAN	309/420	04.2002	05.2005	RFN 52 LZDPF5	A153		1,1	
	6.0 W12 4motion	BRN/BTT	331/450	05.2005	03.2016	RFN 52 LZDPF5	A153		1,1	
POLO I (86)	0.8	HE	25/34	04.1975	09.1981	C 62 LS	A4	B5	0,7	L65
	0.9	HA	29/39	04.1975	09.1981	C 62 LS	A4	B5	0,7	L65

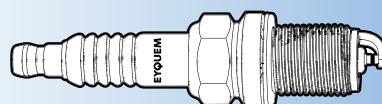

(1) Available until end of stock

- (a) 30 000 km
- (b) 60 000 km
- (c) Grey sticker on ignition coil
- (d) Green sticker on ignition coil

- (e) Hex 21 mm
- (f) Hex 16 mm
- (g) Recommended for cold weather



kW/HP



Box
10

Blister
4



F3-1

VOLKSWAGEN

	1.1	HB-HD-HC	37-44/50-60	04.1975	07.1983	C 62 LS	A4	B5	0,7	L65
	1.3 Coupé	HJ	43/58	01.1977	07.1983	C 62 LS	A4	B5	0,7	L65
	1.3 Coupé	HH	44/60	01.1977	07.1983	C 62 LS	A4	B5	0,7	L65
POLO II (86C, 80)	0.9	HA	29/39	10.1981	12.1981	C 62 LS	A4	B5	0,7	L65
	1.0 Coupé	GL	29/39	10.1981	10.1986	C 62 LS	A4	B5	0,7	L65
	1.0	HZ	33/45	08.1985	12.1992	C 62 LS (c)	A4	B5	0,7	L65
	1.0	HZ	33/45	08.1985	12.1992	C 62 LS3X (d)	A13	B15	0,8	L65
	1.0 CAT	AAK	33/45	08.1989	12.1992	C 62 LS3X	A13	B15	0,8	L65
	1.0 CAT	ACM	33/45	08.1989	07.1994	C 62 LS3X	A13	B15	0,8	L65
	1.0 CAT	AAU	33/45	08.1990	09.1994	C 52 LS3X	A28	B25	0,9	L65
	1.3	HK-MH	40/54	08.1983	07.1988	C 62 LS	A4	B5	0,7	L65
	1.3	HK-MH	40/54	08.1983	07.1988	C 62 LS3X	A13	B15	0,8	L65
	1.3 CAT	MH-NZ-2G	40/55	07.1987	09.1994	C 62 LS	A4	B5	0,7	L65
	1.3 CAT	MH-NZ-2G	40/55	07.1987	09.1994	C 62 LS3X	A13	B15	0,8	L65
	1.3 CAT	AAV	40/54	07.1987	09.1994	C 52 LS3X	A28	B25	0,9	L65
	1.3	HH	44/60	10.1981	07.1983	C 62 LS	A4	B5	0,7	L65
	1.3	GK	55/75	07.1982	12.1992	C 82 LS (c)	A40	B6	0,7	L87
	1.3	GK	55/75	07.1982	12.1992	C 82 LS3X (d)	A92		0,8	L87
	1.3 i CLi, Coupé, GT	3F	55-57/75-78	10.1989	09.1994	C 72 LS3X	A63		0,8	L87
POLO II CLASSIC (86C, 80)	1.0	GL	29/39	01.1985	10.1990	C 62 LS (c)	A4	B5	0,7	L65
	1.0	AAK-HZ	33/45	01.1985	09.1994	C 62 LS3X	A13	B15	0,8	L65
	1.0	AAU	33/45	01.1985	09.1994	C 52 LS3X	A28	B25	0,9	L65
	1.3	HK	40/54	01.1985	07.1987	C 62 LS (c)	A4	B5	0,7	L65
	1.3	MH	40/54	01.1985	07.1987	C 62 LS3X	A13	B15	0,8	L65
	1.3 CAT	MH-NZ	40/55	07.1987	09.1994	C 62 LS3X	A13	B15	0,8	L65
POLO II Coupe (86C, 80)	1.0	GL	29/40	05.1982	10.1986	C 62 LS	A4	B5	0,7	L65
	1.0	HZ	33/45	08.1985	12.1992	C 62 LS (c)	A4	B5	0,7	L65
	1.0	HZ	33/45	08.1985	12.1992	C 62 LS3X (d)	A13	B15	0,8	L65
	1.0 CAT	AAK-ACM	33/45	08.1989	07.1994	C 62 LS3X	A13	B15	0,8	L65
	1.0 CAT	AAU	33/45	08.1990	09.1994	C 52 LS3X	A28	B25	0,9	L65
	1.0	HB	37/50	10.1981	07.1983	C 62 LS (c)	A4	B5	0,7	L65
	1.3	HW	37/50	08.1983	07.1985	C 62 LS	A4	B5	0,7	L65
	1.3	NU	37/50	08.1985	12.1987	C 62 LS3X	A13	B15	0,8	L65
	1.3	HK-MH	40/54	08.1983	06.1987	C 62 LS	A4	B5	0,7	L65
	1.3	HK-MH	40/54	08.1983	06.1987	C 62 LS3X	A13	B15	0,8	L65
	1.3 CAT	MH-NZ-2G	40/55	07.1987	08.1994	C 62 LS	A4	B5	0,7	L65
	1.3 CAT	MH-NZ-2G	40/55	07.1987	08.1994	C 62 LS3X	A13	B15	0,8	L65
	1.3 CAT	AAV	40/54	07.1987	08.1994	C 52 LS3X	A28	B25	0,9	L65
	1.3	GT	43-44/58-60	08.1982	12.1988	C 62 LS	A4	B5	0,7	L65
	1.3	HH	44/60	10.1981	07.1983	C 62 LS	A4	B5	0,7	L65
	1.3	GK	55/75	09.1982	09.1989	C 82 LS (c)	A40	B6	0,7	L87
	1.3	GK	55/75	09.1982	09.1989	C 82 LS3X (d)	A92		0,8	L87
	1.3	3F	55/75	10.1989	09.1994	C 72 LS3X	A63		0,8	L87
	1.3	3F	57/78	03.1991	09.1994	C 72 LS3X	A63		0,8	L87
	1.3 G40	PY	83/113	08.1990	08.1994	C 82 LS3X	A92		0,8	L87
	1.3 GT, G40	PY	85/115	01.1987	09.1990	C 82 LS3X	A92		0,8	L87
POLO II Camionnette (86CF)	1.0	AAU	33/45	08.1992	07.1994	C 52 LS3X	A28	B25	0,9	L65
	1.3	AAV	40/54	08.1992	09.1994	C 52 LS3X	A28	B25	0,9	L65
POLO III (6N1)	1.0 i	AER	37/50	03.1996	10.1999	RC 58 LZ3EX	A34	B54	0,9	L65
	1.0 i	ALL	37/50	05.1997	10.1999	RC 58 LZ3EX	A34	B54	0,9	L65
	1.0 i	AEV	33/45	10.1994	09.1996	RC 58 LZ3EX	A34	B54	0,9	L65
	1.3 i	ADX	40/54	10.1994	04.1997	RC 58 LZ3EX	A34	B54	0,9	L65
	1.4 i	AEX	44/60	10.1994	10.1999	RC 58 LZ3EX	A34	B54	0,9	L65
	1.4 i	AEX-AKV-APQ	44/60	07.1995	10.1999	RC 58 LZ3EX	A34	B54	0,9	L65
	1.4 i 16V	AFH	74/101	04.1996	10.1999	RFC 58 LZ3EX	A58	B55	0,9	F54
	1.6 i	AEE-AEA	55/75	10.1994	10.1999	RC 58 LZ3EX	A34	B54	0,9	L65
	1.6 i	AHS	55/75	10.1994	10.1999	RC 52 LZ3EX	A35		0,9	L65
	1.6 16V GTI	AJV	88/120	09.1998	10.1999	RFC 58 LZ3EX	A58	B55	0,9	F54
POLO III Camionnette (6NF)	1.0 i	AEV	33/45	10.1994	12.1999	RC 52 LZ3EX	A35		0,9	L65
	1.4 i	AEX-APQ	44/60	05.1998	12.1999	RC 58 LZ3EX	A34	B54	0,9	L65

(1) Available until end of stock

(a) 30 000 km

(b) 60 000 km

(c) Grey sticker on ignition coil

(d) Green sticker on ignition coil

(e) Hex 21 mm

(f) Hex 16 mm

(g) Recommended for cold weather



EYQUEM

241



Box
10

Blister
4



F3 → 1

VOLKSWAGEN

POLO III CLASSIC (6KV2)	1.4 i	ANX	44/60	01.1998	08.1999	RC 58 LZ3EX	A34	B54	0,9	L65
	1.4 i	AEX-AKV-APQ	44/60	12.1995	09.2001	RC 58 LZ3EX	A34	B54	0,9	L65
	1.4 i	AKK-ANW-AUD	44/60	12.1995	09.2001	RFN 52 LZDPF5	A153		1,0	
	1.4 i 16V	APE-AUA	55/75	10.1999	09.2001	RFC 58 LZ3EX	A58	B55	0,9	F54
	1.6 i	1F	55/75	11.1995	09.1997	RC 52 LZ3EX	A35		0,9	L65
	1.6 i	AKL-AEH-AUR-AFT-APF	74/101	12.1995	09.2001	RFC 58 LZ3EX	A58	B55	0,9	F54
	1.6 i	AEE-ALM	55/75	11.1995	09.2001	RC 58 LZ3EX	A34	B54	0,9	L65
	1.8 i	ADD-ADZ	66/90	01.1997	09.2001	RC 58 LZ3EX	A34	B54	0,9	L65
POLO III Variant (6KV5)	1.4	AKP	40/54	12.1998	09.2001	RFN 52 LZDPF5	A153		1,0	
	1.4	AEX-AKV-APQ	44/60	04.1997	09.2001	RC 58 LZ3EX	A34	B54	0,9	L65
	1.4	AKK-ANW-AUD	44/60	04.1997	09.2001	RFN 52 LZDPF5	A153		1,0	
	1.4 16V	AUA-APE	55/75	10.1999	09.2001	RFC 58 LZ3EX	A58	B55	0,9	F54
	1.6 i	AEE-ALM	55/75	05.1997	09.2001	RC 58 LZ3EX	A34	B54	0,9	L65
	1.6 i	AKL-AEH-AUR-AFT-APF	74/101	05.1997	09.2001	RFC 58 LZ3EX	A58	B55	0,9	F54
	1.8 i	ADZ	66/90	05.1997	09.2001	RC 58 LZ3EX	A34	B54	0,9	L65
POLO IV (6N2)	1.0	ALD-ANV-AUC	37/50	10.1999	09.2001	RFN 52 LZDPF5	A153		1,0	
	1.4	AKP-ANX	40/54	10.1999	09.2001	RFN 52 LZDPF5	A153		1,0	
	1.4 i	AKK-AUD	44/60	10.1999	09.2001	RFN 52 LZDPF5	A153		1,0	
	1.4 i 16V	AHW-AUA	55/75	10.1999	09.2001	RFC 58 LZ3EX	A58	B55	0,9	F54
	1.4 16V	AFK/AUB	74/101	10.1999	09.2001	RFC 58 LZ3EX	A58	B55	0,9	F54
	1.4 i	ANM	74/101	07.1998		RFC 58 LZ3EX	A58	B55	0,9	F54
	1.4 i 16V	AFK-AUB-AQQ	74/101	10.1999	09.2001	RFC 58 LZ3EX	A58	B55	0,9	F54
	1.6 i	AEH-AKL-AUR	74/101	10.1999		RFC 58 LZ3EX	A58	B55	0,9	F54
	1.6 i 16V GTI	AJV	88/120	04.1998		RFC 58 LZ3EX	A58	B55	0,9	F54
	1.6 16V GTI	ARC/AVY	92/125	10.1999	09.2001	RFC 58 LZ3EX	A58	B55	0,9	F54
POLO V (9N_)	1.2	AWY/BMD	40/54	01.2002	05.2007	FN 58 LZKFR	A183		0,9	
	1.2	BBM	44/60	05.2007	11.2007	FN 58 LZKFR	A183		0,9	
	1.2	BBM	44/60	11.2007	11.2009	FN 58 LZKFR5	A521		1,05	
	1.2 12V	AZQ/BME	47/64	10.2001	07.2007	FN 58 LZKFR	A183		0,9	
	1.2 12V	BZG	51/69	05.2007	11.2007	FN 58 LZKFR	A183		0,9	
	1.2 12V	BZG	51/69	11.2007	11.2009	FN 58 LZKFR5	A521		1,05	
	1.4 16V	BKY	55/75	10.2001	05.2008	FN 58 LZKFR	A183		0,9	
	1.4 16V	BBY/AUA	55/75	10.2001	05.2008	RFC 58 LZ3EX	A58	B55	0,9	F54
	1.4 16V	BBY	55/75	10.2001	05.2008	RFN 52 LZDPF5	A153		1,0	
	1.4 16V	BUD	59/80	05.2006	11.2009	FN 58 LZKFR5	A521		1,05	
	1.4 16V	AUB-BBZ	74/101	10.2001	05.2008	RFC 58 LZ3EX	A58	B55	0,9	F54
	1.6 16V	BTS	77/105	05.2006		FN 58 LZKFR	A183		0,9	
	1.8 GTI	BJX	110/150	09.2005	11.2009	FN 58 LZDPR	A198		0,75	
	1.8 GTI Cup Edition	BBU	132/180	05.2006	11.2009	FN 58 LZDPR	A198		0,75	
POLO V A (9A4)	1.4	BKY	55/75	07.2003		FN 58 LZKFR	A183		0,9	
	1.4	BBY	55/75	07.2003		RFC 58 LZ3EX	A58	B55	0,9	F54
	1.4	BBY	55/75	07.2003		RFN 52 LZDPF5	A153		1,0	
	1.4	BBZ	74/101	11.2003		RFC 58 LZ3EX	A58	B55	0,9	F54
POLO VI (6R, 6C)	1.2	CGPB	44/60	06.2009		FN 58 LZKFR5	A521		1,05	
	1.2	CGPA	51/69	06.2009		FN 58 LZKFR5	A521		1,05	
	NEW 1.0 TSI	CHZB	70/95	11.2014		ZN 62 LSDPFRSO	A538		0,75	
	NEW 1.0 TSI	CHZC	81/110	11.2014		ZN 62 LSDPFRSO	A538		0,75	
	NEW 1.2 TSI	CBZC	66/90	05.2011	05.2014	FN 68 LZIPFRS	A548		0,7	
	NEW 1.2 TSI	CBZB	77/105	11.2009		FN 68 LZIPFRS	A548		0,7	
	NEW 1.2 TSI 16V	CJZC	66/90	02.2014		ZN 62 LSDPFRSO	A538		0,75	
	NEW 1.2 TSI	CJZD	81/110	01.2014		ZN 62 LSDPFRSO	A538		0,75	
	1.4 BiFuel	CMAA	60/82	03.2010	01.2011	FN 58 LZKFR	A183		0,9	
	1.4	CGGB/CLPA	63/86	06.2009		FN 58 LZKFR5	A521		1,05	
	NEW 1.4 TSI	CPTA	103/140	10.2012		ZN 62 LSDPFRSO	A538		0,75	
	NEW 1.4 TSI	CZEA	110/150	05.2014		ZN 62 LSDPFRSO	A538		0,75	
	1.6 BiFuel	CNKA	60/82	01.2011		FN 58 LZKFR5	A521		1,05	
	1.6	CLSA	77/105	01.2010		FN 58 LZKFR5	A521		1,05	
	NEW 1.8 GTI	DAJB	141/192	11.2014		FN 72 HZIPRSO	A537		0,75	
	2.0 R WRC	CDLJ	162/220	08.2013		FN 68 LZDPR	A523		0,7	
POLO VI (6R1, 6C1)	NEW 1.4 GTI	CAVE/CTHE	132/180	05.2010		FN 72 LZIPFRS	A551		0,7	
POLO Van (6R)	NEW 1.2 TSI	CJZC	66/90	02.2014		ZN 62 LSDPFRSO	A538		0,75	
	NEW 1.2 TSI	CJZD	81/110	01.2014		ZN 62 LSDPFRSO	A538		0,75	
	NEW 1.4 TSI	CZEA	110/150	05.2014		ZN 62 LSDPFRSO	A538		0,75	



(1) Available until end of stock

(a) 30 000 km

(b) 60 000 km

(c) Grey sticker on ignition coil

(d) Green sticker on ignition coil

(e) Hex 21 mm

(f) Hex 16 mm

(g) Recommended for cold weather



Box 10
Blister 4



F3-1

VOLKSWAGEN

SANTANA (32B)	1.3	FZ	44/60	09.1975	07.1983	RC 72 LS	A32	B26	0,7	L87
	1.3	FY	40/54	09.1975	07.1983	RC 72 LS	A32	B26	0,7	L87
	1.3	EP	44/60	08.1981	07.1984	C 62 LS3X	A13	B15	0,8	L65
	1.6	WV-WVA	51-55/69-75	08.1981	07.1983	C 62 LS	A4	B5	0,7	L65
	1.6	YP	63/86	09.1975	12.1982	C 62 LS	A4	B5	0,7	L65
	1.6	WP	48/65	08.1979	01.1982	C 62 LS	A4	B5	0,7	L65
	1.6	WY	55/75	09.1979	07.1983	C 52 LS	A1	B1	0,7	L65
	1.6	DT-JU	55/75	08.1983	07.1987	C 62 LS	A4	B5	0,7	L65
	1.8	DS-JN-JV	66/90	09.1982	04.1988	C 62 LS3X	A13	B15	0,8	L65
	1.8	JV	66/90	09.1982	04.1988	RC 52 LS	A9	B20	0,8	L65
	1.8 i	DZ	82/112	09.1982	04.1988	C 62 LS3X	A13	B15	0,8	L65
	1.9	WN	85/115	10.1980	08.1983	C 82 LS3X	A92		0,8	L87
	1.9	WN	85/115	10.1980	08.1983	C 82 LS	A40	B6	0,7	L87
	2.0	HP	85/115	08.1983	12.1984	C 62 LS3X	A13	B15	0,8	L65
	2.0 i	JS	85/115	08.1983	07.1985	C 62 LS3X	A13	B15	0,8	L65
	2.1 L5	WE	85/115	03.1977	07.1983	C 62 LS	A4	B5	0,7	L65
	2.1 L5	KM	77/105	09.1982	07.1984	C 82 LS	A40	B6	0,7	L87
SCIROCCO I (53)	1.1	FA-FJ	37-38/50-52	04.1974	07.1979	C 62 LS	A4	B5	0,7	L65
	1.3	HK-GT-GF	40-43/54-60	08.1979	07.1984	C 62 LS	A4	B5	0,7	L65
	1.5	JB	51/69	08.1977	07.1984	C 52 LS	A1	B1	0,7	L65
	1.5	FH	51/69	02.1974	07.1977	C 62 LS	A4	B5	0,7	L65
	1.5	ZB-YJ	55/75	02.1974	08.1975	C 62 LS	A4	B5	0,7	L65
	1.5	FD	63/86	02.1974	12.1977	C 82 LS	A40	B6	0,7	L87
	1.5	FB	55/75	02.1974	07.1977	C 62 LS	A4	B5	0,7	L65
	1.5	GH	48/65	08.1977	07.1984	C 52 LS	A1	B1	0,7	L65
	1.6	FV	51/69	02.1976	07.1979	C 62 LS	A4	B5	0,7	L65
	1.6	FP	55/75	08.1975	08.1977	RC 72 LS	A32	B26	0,7	L87
	1.6	FN	55/75	01.1976	07.1979	C 62 LS	A4	B5	0,7	L65
	1.6	EM	55/75	08.1975	07.1984	C 62 LS	A4	B5	0,7	L65
	1.6	FR	63/86	08.1975	07.1984	C 62 LS	A4	B5	0,7	L65
	1.6 GTi	EG	81/110	06.1976	07.1982	C 82 LS3X	A92		0,8	L87
	1.6 GTi	EG	81/110	06.1976	07.1982	C 82 LS	A40	B6	0,7	L87
SCIROCCO II (53B)	1.3	HK	40/55	08.1983	07.1984	C 62 LS	A4	B5	0,7	L65
	1.3	GF	44/60	08.1980	12.1983	C 62 LS	A4	B5	0,7	L65
	1.5	JB	51/70	08.1980	12.1983	C 52 LS	A1	B1	0,7	L65
	1.6	EM	55/75	08.1983	07.1983	C 62 LS	A4	B5	0,7	L65
	1.6	HN	55/75	08.1983	07.1986	C 52 LS3X	A28	B25	0,9	L65
	1.6	EW	51-55/69-75	01.1983	07.1992	C 52 LS3X	A28	B25	0,9	L65
	1.6	EWA	51/69	01.1983	07.1987	C 52 LS3X	A28	B25	0,9	L65
	1.6	FR	63/86	08.1980	04.1984	C 62 LS	A4	B5	0,7	L65
	1.6 GTi	EG	81/110	08.1980	07.1982	C 82 LS3X	A92		0,8	L87
	1.6 GTi	EG	81/110	08.1980	07.1982	C 82 LS	A40	B6	0,7	L87
	1.6	RE	53/72	04.1986	07.1990	C 52 LS3X	A28	B25	0,9	L65
	1.6	RE	53/72	04.1986	07.1990	RC 52 LZ3EX	A35		0,9	L65
	1.8 GT	EX	66/90	08.1983	07.1992	C 62 LS3X	A13	B15	0,8	L65
	1.8	JH	70/95	11.1985	07.1992	RC 58 LZ3EX	A34	B54	0,9	L65
	1.8	PB	82/112	08.1982	12.1989	C 62 LS	A4	B5	0,7	L65
	1.8 i GT, GTX	DX	82/112	08.1982	07.1992	C 62 LS3X	A13	B15	0,8	L65
	1.8	DX-JJ-KT	82/112	08.1982	12.1989	C 62 LS3X	A13	B15	0,8	L65
	1.8 i 16V GT, GTX	PL	95/129	01.1986	07.1992	RFC 62 LZ3EX	A86		0,9	F86
	1.8 i 16V GT, GTX	KR	100-102/136-139	10.1985	07.1989	FC 62 LS3X	A57		0,9	F86
	1.8 i 16V GT, GTX	KR	100-102/136-139	10.1985	07.1989	RFC 62 LS3X	A59		0,9	F86
SCIROCCO III (137, 138)	1.4 TSi	CAXA/CMSB	90/122	08.2008		FC 62 LSDPR	A522		0,9	
NEW	1.4 TSi	CZDA	110/150	07.2015		ZN 62 LSDPFRSO	A538		0,75	
NEW	1.4 TSi	CAVD	118/160	05.2008	11.2017	FN 72 LZIPFRS	A551		0,7	
NEW	2.0 TSi	CULA	132/180	11.2013		FN 72 HZIPRSO	A537		0,75	
	2.0 TSi	CAWB	147/200	05.2008	11.2009	FN 68 LZDPR	A523		0,7	
	2.0 TSi	CCZB	155/211	11.2009	05.2014	FN 68 LZDPR	A523		0,7	
NEW	2.0 TSi	CULC	162/220	11.2013		FN 72 HZIPRSO	A537		0,75	
	2.0 R	CDLC	188/256	11.2009		FN 68 LZDPR	A523		0,7	
	2.0 R	CDLA	195/265	11.2009		FN 68 LZDPR	A523		0,7	
	2.0 R	CDLK	206/280	05.2014		FN 68 LZDPR	A523		0,7	
SHARAN I (7M8, 7M9, 7M6)	1.8 T 20V	AJH	110/150	09.1997	03.2010	RFC 58 LZ3EX	A58	B55	0,9	F54
	1.8 T 20V	AWC	110/150	09.1997	03.2010	FN 58 LZDPR	A198		0,75	

(1) Available until end of stock

(a) 30 000 km

(b) 60 000 km

(c) Grey sticker on ignition coil

(d) Green sticker on ignition coil

(e) Hex 21 mm

(f) Hex 16 mm

(g) Recommended for cold weather



EYQUEM



Box 10
Blister 4



F3 → 1

VOLKSWAGEN

	2.0	ADY-ATM	85/115	09.1995	03.2010	RFC 58 LZ3EX	A58	B55	0,9	F54
	2.0 LPG	ATM	85/115	04.2006	03.2010	RFC 58 LZ3EX	A58	B55	0,9	F54
	2.0 i	AKT	85/115	01.1997		RFC 58 LZ3EX	A58	B55	0,9	F54
	2.0 i 16V	ABF	110/150	05.1995		RFC 58 LZ3EX	A58	B55	0,9	F54
	2.8 VR6	AAA-AMY	128/174	09.1995	04.2000	RFC 42 LZ4E	A154		1,6	
	2.8 VR6 LPG	AAA-AMY	128/174	09.1995	04.2000	RFC 52 LZ4E	A159		1,6	
	2.8 VR6 Syncro	AAA-AMY	128/174	11.1996	04.2000	RFC 42 LZ4E	A154		1,6	
	2.8 VR6 LPG Syncro	AAA-AMY	128/174	11.1996	04.2000	RFC 52 LZ4E	A159		1,6	
	2.8 i V6 24V, 4 Motion	AYL	150/204	04.2000	03.2010	RFN 52 LZDPF5	A153		1,0	
SHARAN II (7N1, 7N2)	NEW 1.4 TSI	CAVA	110/150	05.2010		FN 72 LZIPFRS	A551		0,7	
	NEW 1.4 TSI	CZDA	110/150	05.2015		ZN 62 LSDPFRSO	A538		0,75	
	2.0 TSI	CCZA	147/200	12.2010		FN 68 LZDPR	A523		0,7	
	NEW 2.0 TSI	DEDA	162/220	05.2015		FN 72 HZIPRSO	A537		0,75	
TARO	1.8	2Y	61/83	04.1989	09.1994	RC 52 LS	A9	B20	0,8	L65
	2.2, 4x4	4Y	69/94	06.1989	07.1994	RC 52 LS	A9	B20	0,8	L65
	2.4	22R	84/114	06.1989	03.1997	RC 52 LS	A9	B20	0,8	L65
	2.4 i 4x4	22R	84/114	06.1989	03.1997	RC 32 LS	A49	B19	0,75	L3
TIGUAN I (5N_)	1.4 TSI	CAXA	90/122	08.2010		FC 62 LSDPR	A522		0,9	
TIGUAN I (5N)	NEW 1.4 TSI	CZDB	92/125	05.2015		ZN 62 LSDPFRSO	A538		0,75	
	NEW 1.4 TSI	BWK	110/150	05.2008	11.2008	FN 72 LZIPFRS	A551		0,7	
TIGUAN I (5N_)	1.4 TSI	CAVA/CTHA	110/150	05.2008		FN 72 LZIPFRS	A551		0,7	
TIGUAN I (5N)	NEW 1.4 TSI	CZDA	110/150	05.2015		ZN 62 LSDPFRSO	A538		0,75	
	NEW 1.4 TSI	CAVD/CTHD	118/160	05.2011		FN 72 LZIPFRS	A551		0,7	
	NEW 1.4 TSI 4motion	BWK	110/150	11.2007	11.2008	FN 72 LZIPFRS	A551		0,7	
	NEW 1.4 TSI 4motion	CAVA	110/150	05.2008		FN 72 LZIPFRS	A551		0,7	
	NEW 1.4 TSI 4motion	CAVD/CTHD	118/160	05.2011		FN 72 LZIPFRS	A551		0,7	
TIGUAN I (5N_)	2.0 TFSI 4motion	CAWA/CCZC	125/170	09.2007		FN 68 LZDPR	A523		0,7	
TIGUAN I (5N)	2.0 TSI 4motion	CCZD	132/180	05.2011		FN 68 LZDPR	A523		0,7	
TIGUAN I (5N_)	2.0 TFSI	CCTA	147/200	11.2007		FN 68 LZDPR	A523		0,7	
	2.0 TFSI 4motion	CAWB/CCTA/CCZA	147/200	09.2007		FN 68 LZDPR	A523		0,7	
	2.0 TSI 4motion	CCZB	155/211	05.2011		FN 68 LZDPR	A523		0,7	
TIGUAN (AD1)	NEW 2.0 TSI 4motion	CZPA	132/180	01.2016		FN 72 HZIPRSO	A537		0,75	
	NEW 2.0 TSI 4motion	CHHB	162/220	06.2016		FN 72 HZIPRSO	A537		0,75	
TOUAREG (7LA, 7L6, 7L7)	4.2 V8	AXQ/BHX	228/310	12.2002	11.2006	RFC 52 LZ4E	A159		1,6	
	6.0 W12	BJM/CFRA	331/450	08.2004	05.2010	RFN 52 LZDPF5	A153		1,0	
TOUAREG (7P5)	3.0 V6 TSI Hybrid	CGFA/CGEA	245/333	04.2010		FN 68 LZDPR	A523		0,7	
TOURAN (1T1, 1T2)	1.4 FSI	BLG	125/170	11.2006	11.2008	FC 62 LSDPR	A522		0,9	
	NEW 1.4 FSI	CAVB	125/170	11.2008		FN 72 LZIPFRS	A551		0,7	
	NEW 1.4 TSI	BMV	103/140	02.2006		FN 72 LZIPFRS	A551		0,7	
	NEW 1.4 TSI	CAVC (OE: 03C 905 601 A/B)	103/140	11.2008		FN 72 LZIPFRS	A551		0,7	
	1.6	BGU/BSE/BSF	75/102	07.2003		RFC 58 LZ3EX	A58	B55	0,9	F54
	2.0 EcoFuel	BSX	80/109	02.2006	05.2009	RFN 58 LZDP5	A187		1,1	
	2.0 FSI	BLY/BVZ	110/150	10.2003	01.2007	RFN 58 LZDP5	A187		1,1	
	2.0 FSI	AXW/BLR/BLX/BVY	110/150	10.2003	01.2007	FN 62 LZFDPR2A	A192		1,1	
TOURAN (1T3)	NEW 1.2 TSI	CBZB	77/105	05.2010	05.2015	FN 68 LZIPFRS	A548		0,7	
	NEW 1.4 TSI	CVAC/CTHC	103/140	05.2010	05.2015	FN 72 LZIPFRS	A551		0,7	
	NEW 1.4 TSI	CAVB/CTHB	125/170	05.2010	05.2015	FN 72 LZIPFRS	A551		0,7	
TOURAN (5T1)	NEW 1.2 TSI	CYVB	81/110	05.2015		ZN 62 LSDPFRSO	A538		0,75	
	NEW 1.4 TSI	CZDA	110/150	05.2015		ZN 62 LSDPFRSO	A538		0,75	
	NEW 1.8 TSI	CJSA	132/180	11.2015		FN 72 HZIPRSO	A537		0,75	
TRANSPORTER II Bus	1.6	AF	34/47	08.1967	07.1970	C 32	A33		0,6	
	1.6	AH-AD-AS	37/50	08.1970	04.1979	C 32	A33		0,6	
	1.7	CA-CB	49/66	08.1971	10.1973	C 32	A33		0,6	
	1.8	AP	50/68	11.1973	07.1975	C 32	A33		0,6	
	2.0	GD-CJ-GE	51/70	08.1975	04.1979	C 32	A33		0,6	
TRANSPORTER II Camionnette	1.6	AD-AE-AS	37/50	08.1970	04.1979	C 32	A33		0,6	
	1.7	CA-CB	49/66	08.1971	12.1973	C 32	A33		0,6	
	1.8	AP	50/68	11.1973	07.1975	C 32	A33		0,6	
	2.0	GD-CJ-GE	51/70	08.1975	07.1979	C 32	A33		0,6	
TRANSPORTER II Platform/Chassis	1.6	AS-AD	37/50	08.1968	07.1979	C 32	A33		0,6	



(1) Available until end of stock

- (a) 30 000 km
- (b) 60 000 km
- (c) Grey sticker on ignition coil
- (d) Green sticker on ignition coil

- (e) Hex 21 mm
- (f) Hex 16 mm
- (g) Recommended for cold weather



Box
10

Blister
4



F3→1

VOLKSWAGEN

TRANSPORTER III Bus/Camionnette	1.6	CT	37/50	05.1979	12.1982	C 32	A33		0,6	
	1.9 Syncro	DF	44/60	08.1982	07.1987	C 62 LS3X	A13	B15	0,8	L65
	1.9 Syncro	DF	44/60	08.1987	07.1989	C 62 LS	A4	B5	0,7	L65
	1.9 Syncro	DF	44/60	08.1989	07.1992	C 62 LS3X	A13	B15	0,8	L65
	1.9 Syncro	SP	54/73	08.1982	07.1987	C 62 LS3X	A13	B15	0,8	L65
	1.9, Syncro	DG	57/78	08.1982	07.1987	C 62 LS3X	A13	B15	0,8	L65
	1.9, Syncro	DG	57/78	08.1987	07.1989	C 62 LS	A4	B5	0,7	L65
	1.9, Syncro	DG	57/78	08.1989	07.1992	C 62 LS3X	A13	B15	0,8	L65
	2.1, Syncro	SR	64/87	08.1989	07.1992	C 62 LS3X	A13	B15	0,8	L65
	2.1, Syncro	DJ	82/112	07.1985	07.1987	C 62 LS3X	A13	B15	0,8	L65
	2.1, Syncro	DJ	82/112	08.1987	07.1989	RC 72 LS	A32	B26	0,7	L87
	2.1, Syncro	DJ	82/112	08.1989	07.1992	C 62 LS3X	A13	B15	0,8	L65
TRANSPORTER III Platform/Chassis	1.9 Syncro	DF	44/60	08.1982	07.1987	C 62 LS3X	A13	B15	0,8	L65
	1.9 Syncro	DF	44/60	08.1987	07.1989	C 62 LS	A4	B5	0,7	L65
	1.9 Syncro	DF	44/60	08.1989	07.1992	C 62 LS3X	A13	B15	0,8	L65
	1.9 Syncro	DG	57/78	08.1982	07.1987	C 62 LS3X	A13	B15	0,8	L65
	1.9 Syncro	DG	57/78	08.1987	07.1989	C 62 LS	A4	B5	0,7	L65
	1.9 Syncro	DG	57/78	08.1989	07.1992	C 62 LS3X	A13	B15	0,8	L65
	2.1, Syncro	DJ	82/112	07.1985	07.1987	C 62 LS3X	A13	B15	0,8	L65
	2.1, Syncro	DJ	82/112	08.1987	07.1989	RC 72 LS	A32	B26	0,7	L87
	2.1, Syncro	DJ	82/112	08.1989	07.1992	C 62 LS3X	A13	B15	0,8	L65
TRANSPORTER IV Bus (70XB, 70XC, 7DB, 7DW, 7DK)	1.8	PD	49/67	12.1990	07.1992	C 62 LS3X	A13	B15	0,8	L65
	2.0 i	AAC	62-64/84-87	08.1995	04.2003	RC 52 LZ3EX	A35		0,9	L65
	2.5, Syncro	AAF/ACU/AEN/AEU	81/110	11.1990	04.2003	RC 52 LZ3EX	A35		0,9	L65
	2.5, Syncro	AET	85/115	08.1996	04.2003	RC 52 LZ3EX	A35		0,9	L65
	2.8 VR6	AES	103/140	11.1995	04.2000	RFC 42 LZ4E	A154		1,6	
	2.8 VR6 LPG	AES	103/140	11.1995	04.2000	RFC 52 LZ4E	A159		1,6	
	2.8 V6	AMV	150/204	04.2000	04.2003	RFN 52 LZDPF5	A153		1,0	
TRANSPORTER IV Camionnette (70XA)	2.0	AAC	62/84	08.1995	04.2003	RC 52 LZ3EX	A35		0,9	L65
	2.5, Syncro	AAF/ACU/AEN/AEU	81/110	11.1990	04.2003	RC 52 LZ3EX	A35		0,9	L65
	2.5, Syncro	AET	85/115	01.1996	04.2003	RC 52 LZ3EX	A35		0,9	L65
	2.8 VR6	AES	103/140	05.1996	05.2000	RFC 42 LZ4E	A154		1,6	
	2.8 VR6 LPG	AES	103/140	05.1996	05.2000	RFC 52 LZ4E	A159		1,6	
	2.8 V6	AMV	150/204	06.2000	04.2003	RFN 52 LZDPF5	A153		1,0	
	2.8 i V6 24V	AYL	150/204	04.2000		RFN 52 LZDPF5	A153		1,0	
TRANSPORTER IV Platform/Chassis (70XD)	2.0	PD	49/67	12.1990	07.1992	C 62 LS3X	A13	B15	0,8	L65
	2.0	AAC	62/84	09.1990	04.2003	RC 52 LZ3EX	A35		0,9	L65
	2.5, Syncro	AAF/ACU/AEN/AEU	81/110	11.1990	04.2003	RC 52 LZ3EX	A35		0,9	L65
	2.5, Syncro	AET	85/115	01.1996	04.2003	RC 52 LZ3EX	A35		0,9	L65
TRANSPORTER V Bus (7HB, 7HJ, 7EB, 7EJ, 7EF, 7EG, 7HF, 7EC)	2.0	AXA	85/115	11.2003		RFC 58 LZ3EX	A58	B55	0,9	F54
	2.0 TSI	CJKB	110/150	07.2012		FN 68 LZDPR	A523		0,7	
	2.0 TSI, 4motion	CJKA	150/204	05.2011		FN 68 LZDPR	A523		0,7	
TRANSPORTER V Camionnette (7HA, 7HH, 7EA, 7EH)	2.0	AXA	85/115	11.2003		RFC 58 LZ3EX	A58	B55	0,9	F54
	2.0 TSI	CJKB	110/150	07.2012		FN 68 LZDPR	A523		0,7	
	2.0 TSI, 4motion	CJKA	150/204	05.2011		FN 68 LZDPR	A523		0,7	
TRANSPORTER V Platform/Chassis (7JD, 7JE, 7JL, 7JY, 7JZ, 7FD)	2.0	AXA	85/115	11.2003		RFC 58 LZ3EX	A58	B55	0,9	F54
	2.0 TSI	CJKB	110/150	07.2012		FN 68 LZDPR	A523		0,7	
TRANSPORTER VI Bus (SGB, SGG, SGJ)	2.0 TSI	CJKB	110/150	04.2015		FN 68 LZDPR	A523		0,7	
	2.0 TSI, 4motion	CJKA	150/204	04.2015		FN 68 LZDPR	A523		0,7	
TRANSPORTER VI Camionnette (SGA, SGH)	2.0 TSI	CJKB	110/150	04.2015		FN 68 LZDPR	A523		0,7	

(1) Available until end of stock

(a) 30 000 km

(b) 60 000 km

(c) Grey sticker on ignition coil

(d) Green sticker on ignition coil

(e) Hex 21 mm

(f) Hex 16 mm

(g) Recommended for cold weather



EYQUEM



Box 10
Blister 4



F3-1

VOLKSWAGEN

	2.0 TSI, 4motion	CJKA	150/204	04.2015		FN 68 LZDPR	A523		0,7
TRANSPORTER VI Platform/Chassis (SFD, SFE, SFL)	2.0 TSI	CJKB	110/150	04.2015		FN 68 LZDPR	A523		0,7
UP	NEW 1.0 EcoFuel	CPGA	50/68	11.2012		ZN 62 LSDPFRSO	A538		0,75
	NEW 1.0 TSI	CHZA	66/90	05.2016		ZN 62 LSDPFRSO	A538		0,75
VENTO (1H2)	1.3 i	ADX	44/60	10.1994	10.1998	RC 58 LZ3EX	A34	B54	0,9 L65
	1.4 i	ABD/AEX	40/55	11.1991	09.1998	RC 58 LZ3EX	A34	B54	0,9 L65
	1.4 i	ABD	44/60	11.1991	09.1998	C 52 LS3X	A28	B25	0,9 L65
	1.4 i	AEX	44/60	11.1991	09.1998	RC 58 LZ3EX	A34	B54	0,9 L65
	1.6 i	ABU	55/75	07.1992	09.1994	C 52 LS3X	A28	B25	0,9 L65
	1.6 i	AEA	55/75	07.1994	07.1995	RC 58 LZ3EX	A34	B54	0,9 L65
	1.6 i	AEE	55/75	07.1995	09.1998	RC 58 LZ3EX	A34	B54	0,9 L65
	1.6 i	AFT	74/101	10.1994	09.1998	RFC 58 LZ3EX	A58	B55	0,9 F54
	1.6 i	AEK	74/101	07.1994	12.1995	RFC 58 LZ3EX	A58	B55	0,9 F54
	1.6 i	AKS	74/101	05.1997		RFC 58 LZ3EX	A58	B55	0,9 F54
	1.8 i	AAM	55/75	09.1991	09.1998	RC 52 LZ3EX	A35		0,9 L65
	1.8 i	ABS	66/90	09.1991	08.1994	RC 58 LZ3EX	A34	B54	0,9 L65
	1.8 i	ACC-ADZ	66/90	07.1994	09.1998	RC 58 LZ3EX	A34	B54	0,9 L65
	2.0 i	AEP	79-85/107-115	07.1994	07.1997	RC 58 LZ3EX	A34	B54	0,9 L65
	2.0 i	ADY	85/115	07.1994	09.1998	RC 58 LZ3EX	A34	B54	0,9 L65
	2.0 i	AGG	85/115	07.1995	09.1998	RC 58 LZ3EX	A34	B54	0,9 L65
	2.0 i	AKR	85/115	05.1997	09.1998	RC 58 LZ3EX	A34	B54	0,9 L65
	2.0 i GTI	2E	85/115	09.1991	09.1994	RC 58 LZ3EX	A34	B54	0,9 L65
	2.0 i 16V	ABF	110/150	09.1991	07.1997	RFC 58 LZ3EX	A58	B55	0,9 F54
	2.8 VR6	AAA	128/174	11.1991	09.1998	RFC 42 LZ4E	A154		1,6
	2.8 VR6 LPG	AAA	128/174	11.1991	09.1998	RFC 52 LZ4E	A159		1,6

VOLKSWAGEN (BR)

APOLLO	1.8 GLS	AP 1800	68/92	12.1994		RC 52 LS	A9	B20	0,7 L65
	1.8 GLS	AP 1800	77/105	12.1994		RC 82 LS	A78		0,7 L87
FUSCA	1.6	1600	40/54	08.1993		RC 52 LS	A9	B20	0,7 L65
	1.6	1600	44/60	08.1993		RC 82 LS	A78		0,7 L87
GOLF	1.0 i	AE 1000	38/52	01.1995		RFC 58 LS	A18		0,7 F54
	1.6	AE 1600 Alcool	55/75	07.1990		RFC 62 LS	A48		0,7 F86
	1.6 i	AP 1600	64/87	01.1995		RC 82 LS	A78		0,7 L87
	1.6 Mi	AP 1600	74/101	10.1996		RC 82 LS	A78		0,8 L87
	1.8 GT	AP 1800	63/86	03.1984		RC 52 LS	A9	B20	0,7 L65
	1.8 GT	AP 1800	73/99	03.1984		RC 82 LS	A78		0,7 L87
	1.8 GTS	AP 1800	63/86	03.1984		RC 52 LS	A9	B20	0,7 L65
	1.8 GTS	AP 1800	73/99	03.1984		RC 82 LS	A78		0,7 L87
	1.8 i	AP 1800	75/102	10.1994		RC 82 LS	A78		0,7 L87
	1.8 i Mi	AP 1800	77/105	10.1996		RC 82 LS	A78		0,7 L87
	2.0 i 16V Mi 16	AP 2000	114/155	10.1996		RFC 58 LS	A18		0,7 F54
	2.0 i GTI	AP 2000	89/121	01.1995		RC 62 LS	A6	B17	0,7 L65
	2.0 i GTI	AP 2000	92/125	01.1995		RC 82 LS	A78		0,7 L87
	2.0 i Mi	AP 2000	93/126	10.1996		RC 82 LS	A78		0,7 L87
LOGUS	1.6 CL, GL	AE 1600 Alcool	55/75	02.1993		RFC 62 LS	A48		0,7 F86
	1.6 i	AP 1600	60/82	01.1995		RC 52 LS	A9	B20	0,7 L65
	1.6 i	AP 1600	64/87	01.1995		RC 82 LS	A78		0,7 L87
	1.8 i CL, GL, GLS	AP 1800	70-71/95-97	02.1993		RC 52 LS	A9	B20	0,7 L65
	1.8 i CL, GL, GLS	AP 1800	70-75/95-102	02.1993		RC 82 LS	A78		0,7 L87
	2.0 i	AP 2000	89/121	07.1994		RC 52 LS	A9	B20	0,7 L65
	2.0 i	AP 2000	92/125	07.1994		RC 82 LS	A78		0,7 L87
PARITI	1.6	AE 1600 Alcool	55/75	07.1990		RFC 62 LS	A48		0,7 F86
	1.6 Mi	AP 1600	75/102	10.1996		RC 52 LZ3EX	A35		0,9 L65
	1.8	UD 1800	66/90	01.1988		RC 52 LS	A9	B20	0,7 L65
	1.8	UE 1800	73/99	01.1988		RC 82 LS	A78		0,7 L87
	1.8 i	AP 1800	71/97	10.1994		RC 52 LS	A9	B20	0,7 L65
	1.8 i	AP 1800	72/98	10.1994		RC 82 LS	A78		0,7 L87
	1.8 i Mi	AP 1800	75/102	10.1996		RC 52 LZ3EX	A35		0,9 L65
	2.0 i	AP 2000	71/97	10.1994		RC 62 LS	A6	B17	0,7 L65
	2.0 i	AP 2000	88/120	10.1996		RC 82 LS	A78		0,7 L87
	2.0 i Mi	AP 2000	88/120	10.1996		RC 52 LZ3EX	A35		0,9 L65
SANTANA	1.8	UE 1800	71/97	05.1985		RC 82 LS	A78		0,7 L87

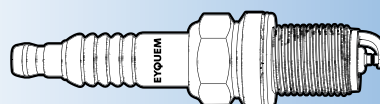

(1) Available until end of stock

- (a) 30 000 km
- (b) 60 000 km
- (c) Grey sticker on ignition coil
- (d) Green sticker on ignition coil

- (e) Hex 21 mm
- (f) Hex 16 mm
- (g) Recommended for cold weather



Box
10

Blister
4



F3-D1

VOLKSWAGEN (BR)

1.8 GL	UD 1800	71/97	04.1991	RC 52 LS	A9	B20	0,7	L65
1.8 GL	AP 1800	73/99	04.1991	RC 82 LS	A78		0,7	L87
1.8 i	AP 1800	71/97	03.1993	RC 52 LS	A9	B20	0,7	L65
1.8 i	AP 1800	75/102	03.1993	RC 82 LS	A78		0,7	L87
1.8 i Mi	AP 1800	75/102	10.1996	RC 52 LZ3EX	A35		0,9	L65
1.8 i Quantum	AP 1800	75/102	12.1994	RC 52 LS	A9	B20	0,7	L65
1.8 Quantum	UD 1800	63-65/86-88	11.1984	RC 52 LS	A9	B20	0,7	L65
1.8 Quantum	AP 1800	71/97	05.1985	RC 82 LS	A78		0,7	L87
2.0 Executive	AP 2000	88/120	08.1989	RC 62 LS	A6	B17	0,7	L65
2.0 GLS	AP 2000	88/120	04.1991	RC 52 LS	A9	B20	0,7	L65
2.0 GLS	AP 2000	93/126	04.1991	RC 82 LS	A78		0,7	L87
2.0 i GLS	AP 2000	88/120	06.1991	RC 62 LS	A6	B17	0,7	L65
2.0 i i Quantum	AP 2000	89/121	01.1994	RC 62 LS	A6	B17	0,7	L65
2.0 i i Quantum	AP 2000	92/125	01.1994	RC 82 LS	A78		0,7	L87
2.0 i Mi	AP 2000	88/120	10.1996	RC 52 LZ3EX	A35		0,9	L65
2.0 Quantum	AP 2000	73/99	04.1988	RC 52 LS	A9	B20	0,7	L65
2.0 Quantum	AP 2000	82/112	04.1988	RC 82 LS	A78		0,7	L87
VOYAGE	1.8	70/95	08.1989	RC 52 LS	A9	B20	0,7	L65

VOLKSWAGEN (ESP)

CADDY	1.4 i	AEX	44/60	11.1995	RC 58 LZ3EX	A34	B54	0,9	L65
	1.6 i	1F	55/75	11.1995	RC 52 LZ3EX	A35		0,9	L65
SANTANA	1.8	DS	66/90	06.1985	C 62 LS3X	A13	B15	0,8	L65
	2.0 i	JS	85/115	06.1985	C 62 LS3X	A13	B15	0,8	L65

VOLKSWAGEN (MEX)

GOLF	1.8 i	RV	77/105	12.1988	12.1991	C 62 LS (c)	A4	B5	0,7	L65
	1.8 i	RV	77/105	12.1988	12.1991	C 62 LS3X (d)	A13	B15	0,8	L65
	1.8 i	PF	79/107	12.1988	12.1991	C 62 LS (c)	A4	B5	0,7	L65
	1.8 i	PF	79/107	12.1988	12.1991	C 62 LS3X (d)	A13	B15	0,8	L65
	1.8 i 16V	PL	95/129	12.1988	07.1989	RFC 62 LZ3EX	A86		0,9	F86
	2.0 i 16V	9A	100/136	01.1990	12.1991	RFC 62 LZ3EX	A86		0,9	F86
KAEFER / BEETLE / COCCINELLE	1.6	ACD	34/46	10.1992		C 32 LS	A31		0,7	L3

VOLKSWAGEN (US)

GOLF	1.8	HT - GX	66/90	08.1984	07.1987	RC 58 LZ3EX	A34	B54	0,9	L65
	1.8 i	RD	79/107	08.1984	07.1987	RC 58 LZ3EX	A34	B54	0,9	L65
RABBIT	1.7	JF	48/65	12.1981	07.1984	C 62 LS	A4	B5	0,7	L65
	1.8	JH	66/90	08.1982	07.1984	RC 58 LZ3EX	A34	B54	0,9	L65

VOLVO

66	1.1	BB110E	33-35/45-47	08.1975	08.1978	C 32 S	A8		0,7	N43
	1.3	B 130	42/57	08.1975	08.1978	C 32 S	A8		0,7	N43
140	142, 144, 145 : 1.8	B 18 A				C 42 S	A12	B7	0,7	N43
	142, 144, 145 : 2.0	B 20 A - B - D			07.1974	C 62 S	A55		0,7	
	142, 144, 145 : 2.0 i	B 20 E - F			07.1974	C 62 S	A55		0,7	
164	164 : 3.0 i	B 30 E			07.1974	C 62 S	A55		0,7	
	164, 165 : 3.0	B 30 A - F			07.1974	C 62 S	A55		0,7	
240	1.8 DL, GL	B 17 A	66/90	11.1978	07.1988	C 62 LS	A4	B5	0,7	L65
	2.0 DL, GL	B 19 A/K	66-74/90-101	09.1976	07.1984	C 62 LS	A4	B5	0,7	L65
	2.0 DL, GL	B 200 K	72-76/98-103	08.1984	07.1989	RC 62 LS	A6	B17	0,7	L65
	2.0 i DL, GL, GLE, GLT	B 19 E	86/117	09.1976	07.1984	RC 72 LS	A32	B26	0,7	L87
	2.0 i DL, GL, GLE, GLT	B 200 E	82-86/112-117	08.1984	07.1992	RC 72 LS	A32	B26	0,7	L87
	2.0 i DL, GL, GLE, GLT	B 200 F Cat	77-82/105-112	04.1991	08.1993	RC 62 LS	A6	B17	0,7	L65
	2.0 i Turbo GLT	B 19 ET	107/145	08.1981	07.1984	C 72 LS (1)	A30		0,7	L87
	2.0 i Turbo GLT	B 200 FT	105/143	08.1984	08.1993	RC 62 LS	A6	B17	0,7	L65
	2.0 i Turbo GLT	B 200 ET	120/163	08.1984	08.1993	RC 62 LS	A6	B17	0,7	L65
	2.1 DL, GL	B 21 A	74-80/101-109	08.1974	07.1984	C 62 LS	A4	B5	0,7	L65
	2.1 i DL, GL, GLE, GLT	B 21 E	90/122	08.1974	07.1982	C 72 LS (1)	A30		0,7	L87
	2.1 i Turbo GLE, GLT	B 21 ET	114/155	08.1980	07.1986	C 72 LS (1)	A30		0,7	L87
	2.3 DL, GL, GLE, GLT	B 23 A	82/112	08.1984	07.1988	C 62 LS	A4	B5	0,7	L65
	2.3 GL	B 230 K	78-81/106-110	08.1984	07.1986	C 62 LS	A4	B5	0,7	L65
	2.3 i DL, GL, GLE, GLT	B 230 A	78/106	08.1984	07.1988	RC 62 LS	A6	B17	0,7	L65
	2.3 i DL, GL, GLE, GLT, SE	B 23 E	103/140	03.1979	07.1992	RC 72 LS	A32	B26	0,7	L87

(1) Available until end of stock

(a) 30 000 km

(b) 60 000 km

(c) Grey sticker on ignition coil

(d) Green sticker on ignition coil

(e) Hex 21 mm

(f) Hex 16 mm

(g) Recommended for cold weather

(g) Recommended for cold weather



EYQUEM



Box
10
Blister
4



F3

VOLVO										
	2.3 i DL, GL, GLE, GLT, SE	B 230 E	95-96/129-131	03.1979	07.1992	RC 72 LS	A32	B26	0,7	L87
	2.3 i DL, GL, GLE, GLT, SE	B 230 F Cat	84-85/114-116	08.1984	08.1993	RC 62 LS	A6	B17	0,7	L65
	2.3 i DL, GL, GLE, GLT, SE	B 230 FD Cat	85/115	08.1992	08.1993	RC 62 LS	A6	B17	0,7	L65
	2.3 i GL	B 230 K	78-81/106-110	08.1986	07.1990	RC 72 LS	A32	B26	0,7	L87
	2.3 i Turbo GLT	B 230 ET	134/182	08.1984	08.1993	RC 62 LS	A6	B17	0,7	L65
	2.8 i V6	B 28 E	114/155	08.1980	07.1984	RC 72 LJS	A88		0,7	J87
260	2.3	B 23 A	78-82/106-112	08.1981	07.1982	C 62 LS	A4	B5	0,7	L65
	2.7 i V6 Coupé	B 27 E	103/140	08.1974	07.1980	RC 72 LJS	A88		0,7	J87
	2.7 V6	B 27 A	92/125	08.1974	07.1982	RC 72 LJS	A88		0,7	J87
	2.8 i V6 Coupé	B 28 E	114/155	08.1980	07.1984	RC 72 LJS	A88		0,7	J87
	2.8 V6 Coupé	B 28 A	95/129	08.1979	07.1982	RC 72 LJS	A88		0,7	J87
360	1.3 DL, GL, GLE	B 13 E		01.1989		RC 62 LS	A6	B17	0,7	L65
	2.0 DL, GL, GLE	B 19 A	65-70/88-95	08.1982	07.1984	RC 62 LS	A6	B17	0,7	L65
	2.0 i DL, GL, GLE	B 200 K	76/103	08.1984	07.1990	RC 62 LS	A6	B17	0,7	L65
	2.0 i DL, GL, GLE, GLT	B 19 E	83-86/113-117	08.1982	07.1984	RC 72 LS	A32	B26	0,7	L87
	2.0 i DL, GL, GLE, GLT	B 200 EE - ES - E - F	82/112	08.1984	07.1990	RC 72 LS	A32	B26	0,7	L87
440	1.6 i DL, GL, GLE, GLT, SE	B 16F Cat	61-69/83-94	09.1988	08.1997	RC 62 LS	A6	B17	0,7	L65
	1.7 i DL, ES, GL, GLE, GLT, SE	B 18 ES	75-90/102-122	09.1988	09.1989	RC 62 LS	A6	B17	0,7	L65
	1.7 i DL, ES, GL, GLE, GLT, SE	B 18 ED	78/106	09.1988	12.1989	RC 62 LS	A6	B17	0,7	L65
	1.7 i DL, ES, GL, GLE, GLT, SE	B 18 EP	78-80/106-109	09.1988	08.1997	RC 62 LS	A6	B17	0,7	L65
	1.7 i DL, ES, GL, GLE, GLT, SE	B 18 E	88/120	09.1988	09.1989	RC 62 LS	A6	B17	0,7	L65
	1.7 i DL, ES, GL, GLE, GLT, SE	B 18 FP	75/102	08.1989	12.1993	RC 62 LS	A6	B17	0,7	L65
	1.7 i DL, GL, GLE, GLT, SE	B 18 K	58-60/79-82	09.1988	08.1994	RC 62 LS	A6	B17	0,7	L65
	1.7 i DL, GL, GLE, GLT, SE	B 18 KPD	64-66/87-90	09.1988	02.1992	RC 62 LS	A6	B17	0,7	L65
	1.7 i DL, GL, GLE, GLT, SE	B 18 KP	64-66/87-90	09.1988	08.1997	RC 62 LS	A6	B17	0,7	L65
	1.7 i DL, GL, GLE, GLT, SE	B 18 F	70-75/95-102	09.1988	03.1992	RC 62 LS	A6	B17	0,7	L65
	1.7 i DL, GL, GLE, GLT, SE	B 18 KD	57/78	09.1989	12.1991	RC 62 LS	A6	B17	0,7	L65
	1.7 i Turbo	B 18 FT - FTM	88-90/120-122	09.1988	08.1997	RC 72 LS	A32	B26	0,7	L87
	1.8 i DL, GL, GLE, GLT, SE	B 18 U Cat	66/90	09.1991	08.1997	RC 62 LS	A6	B17	0,7	L65
	2.0 i	B 20 F Cat	81/110	09.1992	12.1996	RC 72 LS	A32	B26	0,7	L87
480	1.7 i	B 18 ED	78/106	10.1987	08.1988	RC 72 LS	A32	B26	0,7	L87
	1.7 i ES	B 18 E - ES	78-80/106-109	04.1986	07.1989	RC 72 LS	A32	B26	0,7	L87
	1.7 i ES	B 18 F	70-75/95-102	05.1987	12.1993	RC 62 LS	A6	B17	0,7	L65
	1.7 i Turbo	B 18 FT - FTM	88-90/120-122	03.1988	08.1995	RC 72 LS	A32	B26	0,7	L87
	2.0 i	B 20 F Cat	81/110	09.1992	12.1996	RC 72 LS	A32	B26	0,7	L87
740	2.0 DL, DLE, GL	B 200 K	76/103	08.1984	07.1989	RC 62 LS	A6	B17	0,7	L65
	2.0 i 16V GLT	B 204 E	103/140	08.1988	07.1991	RC 72 LS	A32	B26	0,7	L87
	2.0 i 16V Turbo	B 204 GT	136/185	08.1989	08.1991	RC 72 LS	A32	B26	0,7	L87
	2.0 i GL, GLE, SE	B 200 E - G - GE	80-82/109-112	08.1989	08.1994	RC 62 LS	A6	B17	0,7	L65
	2.0 i GLE	B 19 E - B 200 E	86-88/117-120	08.1983	07.1991	RC 72 LS	A32	B26	0,7	L87
	2.0 i Turbo	B 19 ET	110/150	04.1984	07.1984	C 72 LS (1)	A30		0,7	L87
	2.0 i Turbo	B 200 ET	120/163	08.1984	08.1986	C 62 LS	A4	B5	0,7	L65
	2.0 i Turbo	B 200 ET	120/163	09.1986	07.1989	RC 62 LS	A6	B17	0,7	L65
	2.0 i Turbo	B 204 FT Cat	140/190	08.1989	07.1990	RC 62 LS	A6	B17	0,7	L65
	2.0 i Turbo	B 200 FT	105-114/143-155	08.1990	07.1992	RC 72 LS	A32	B26	0,7	L87
	2.3 DL, GL, GLE	B 230 K	84/114	08.1984	07.1986	C 62 LS	A4	B5	0,7	L65
	2.3 i 16V	B 234 G	114/155	08.1990	08.1992	RC 72 LS	A32	B26	0,7	L87
	2.3 i 16V GLT	B 234 F Cat	111-117/151-159	04.1988	07.1991	RC 72 LS	A32	B26	0,7	L87
	2.3 i DL, GL, GLE	B 230 K	84/114	08.1986	07.1990	RC 72 LS	A32	B26	0,7	L87
	2.3 i DL, GL, GLT, SE	B 230 A	82/112	08.1984	07.1987	RC 62 LS	A6	B17	0,7	L65
	2.3 i DL, GL, GLT, SE	B 230 F Cat	85-96/116-130	08.1984	07.1995	RC 62 LS	A6	B17	0,7	L65
	2.3 i GLE	B 230 E	96/131	08.1983	07.1991	RC 72 LS	A32	B26	0,7	L87
	2.3 i GLE, GLT	B 23 E	95/129	04.1983	07.1985	C 72 LS (1)	A30		0,7	L87
	2.3 i GLT, SE	B 230 G	94/128	08.1991	07.1995	RC 62 LS	A6	B17	0,7	L65
	2.3 i Turbo	B 230 FT Cat	114-119/155-162	08.1984	07.1989	RC 62 LS	A6	B17	0,7	L65
	2.3 i Turbo	B 230 ET	130-134/177-182	08.1984	07.1989	RC 62 LS	A6	B17	0,7	L65
	2.3 i Turbo	B 230 GT	120/163	08.1989	07.1990	RC 72 LS	A32	B26	0,7	L87
	2.3 i Turbo	B 230 FT Cat	114-119/155-162	08.1989	07.1991	RC 72 LS	A32	B26	0,7	L87
760	2.0 i 16V Turbo	B 204 GT	136/185	01.1990	07.1992	RC 72 LS	A32	B26	0,7	L87
	2.0 i Turbo	B 200 ET	120/163	08.1984	07.1987	C 72 LS (1)	A30		0,7	L87
	2.0 i Turbo	B 200 ET	120/163	08.1987	07.1989	RC 72 LS	A32	B26	0,7	L87
	2.0 i Turbo	B 204 FT Cat	140/190	01.1990	07.1992	RC 62 LS	A6	B17	0,7	L65
	2.3 i Turbo	B 23 ET	127/173	04.1982	07.1984	C 72 LS (1)	A30		0,7	L87
	2.3 i Turbo	B 230 FT Cat	114-119/155-162	08.1984	07.1992	RC 72 LS	A32	B26	0,7	L87
	2.3 i Turbo	B 230 ET	130-134/177-182	08.1984	07.1992	RC 72 LS	A32	B26	0,7	L87

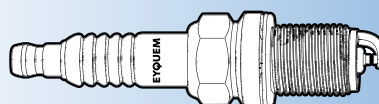

(1) Available until end of stock
(a) 30 000 km
(b) 60 000 km
(c) Grey sticker on ignition coil
(d) Green sticker on ignition coil

(e) Hex 21 mm
(f) Hex 16 mm
(g) Recommended for cold weather



KW/HP



Box 10 Blister 4



F3-D1

VOLVO

	2.3 i Turbo	B 230 GT	120/163	08.1989	07.1990	RC 72 LS	A32	B26	0,7	L87	
	2.8 i V6 GLE	B 28 E	115/156	02.1982	04.1986	RC 72 LJS	A88		0,7	J87	
	2.8 i V6 GLE	B 28 F - B 280 F	100-105/136-143	08.1982	08.1991	RC 72 LJS	A88		0,7	J87	
	2.8 i V6 GLE	B 280 E	108-115-125/ 147-156-170	05.1986	07.1991	RC 72 LJS	A88		0,7	J87	
780	2.8 V6 GLE	B 28 A	96/131	08.1982	07.1986	RC 72 LJS	A88		0,7	J87	
	2.0 i 16V Turbo	B 204 GT	136/185	08.1987	07.1990	RC 72 LS	A32	B26	0,7	L87	
	2.0 i Turbo GLE	B 200 ET	120/163	01.1986	07.1990	RC 72 LS	A32	B26	0,7	L87	
	2.0 i Turbo GLE	B 204 FT Cat	140/190	01.1989	12.1990	RC 72 LS	A32	B26	0,7	L87	
	2.3 i Turbo	B 230 FT Cat	114-119/155-162	01.1989	12.1990	RC 72 LS	A32	B26	0,7	L87	
	2.8 i V6 GLE	B 280 E - F	108-125/147-170	05.1986	07.1991	RC 72 LJS	A88		0,7	J87	
850	2.0 Kombi	B 5202 S	93/126	08.1994	12.1996	RFC 52 LS3	A66		1,2		
	2.0 i 20V S, SE, GLT	B 5204	96-105/130-143	09.1991	12.1996	RFC 58 LS	A18		0,8	F54	
	2.0 i 20V Turbo	B 5204 FT Cat	129-150-155/ 175-204-211	01.1994	12.1997	RFN 58 LZ (b)	A7	B28	0,8	F54	
	2.0 i 20V Turbo	B 5204 FT Cat	129-150-155/ 175-204-211	01.1994	12.1997	RFN 58 LZ3A (g)	A515		0,8		
	2.0 i S, SE, GLT	B 5202 F - S Cat	93/126	09.1994	12.1996	RFC 58 LS	A18		0,8	F54	
	2.3 i 20V Turbo	B 5234 FT Cat	160-166-177-184/ 218-226-241-	09.1993	12.1997	RFN 58 LZ (b)	A7	B28	0,8	F54	
	2.3 i 20V Turbo	B 5234 FT Cat	160-166-177-184/ 218-226-241-	09.1993	12.1997	RFN 58 LZ3A (g)	A515		0,8		
	2.5 Kombi	B 5252	103/140	06.1991	07.1994	RFC 52 LS3	A66		1,2		
	2.5 Kombi	B 5254 S	125/170	08.1991	12.1996	RFC 52 LS3	A66		1,2		
	2.5 Kombi	B 5252 S	106/144	08.1994	12.1996	RFC 52 LS3	A66		1,2		
	2.5 i 20V S, SE, GLT	B 5254 F - S Cat	125/170	09.1991	12.1997	RFC 52 LS	A3	B16	0,7	F54	
	2.5 i 20V Turbo	B 5254 FT	140/190	09.1996	12.1997	RFN 62 LZ	A71		0,8	F86	
940	2.5 i S, SE, GL	B 5252 F - S Cat	103-106/140-144	09.1992	12.1997	RFC 52 LS	A3	B16	0,7	F54	
	2.0 i	B 200 E	88/120	09.1990	08.1991	RC 72 LS	A32	B26	0,7	L87	
	2.0 i 16V GL, GLE, GLT, SE	B 204 E	100-103/136-140	09.1990	08.1991	RC 72 LS	A32	B26	0,7	L87	
	2.0 i 16V Turbo	B 204 GT	140/190	09.1992	08.1994	RC 72 LS	A32	B26	0,7	L87	
	2.0 i GL, GLT, SE	B 200 F - G	80-82/109-112	09.1991	08.1995	RC 62 LS	A6	B17	0,7	L65	
	2.0 i Turbo	B 200 FT	105-114/143-155	01.1991	08.1997	RC 72 LS	A32	B26	0,7	L87	
	2.0 i Turbo	B 204 FT Cat	140/190	09.1992	08.1994	RC 72 LS	A32	B26	0,7	L87	
	2.3 i 16V GL, GLT, SE	B 234 G	114/155	09.1990	08.1992	RC 72 LS	A32	B26	0,7	L87	
	2.3 i 16V GL, GLT, SE	B 234 F Cat	114/155	09.1990	09.1994	RC 72 LS	A32	B26	0,7	L87	
	2.3 i GL, GLE, GLT, SE	B 230 F - B 230 FD Cat	84/114	09.1990	08.1995	RC 62 LS	A6	B17	0,7	L65	
	2.3 i GL, GLE, GLT, SE	B 230 FB Cat	96/131	09.1992	08.1995	RC 62 LS	A6	B17	0,7	L65	
	2.3 i GL, GLT, SE	B 230 G	96/131	09.1991	08.1995	RC 62 LS	A6	B17	0,7	L65	
	2.3 i S, SE	B 230 FK Cat	99/135	09.1994	08.1997	RC 62 LS	A6	B17	0,7	L65	
	2.3 i Turbo	B 230 FT Cat	121/165	09.1990	08.1997	RC 72 LS	A32	B26	0,7	L87	
	2.3 i Turbo	B 230 GT	125/170	09.1991	08.1997	RC 62 LS	A6	B17	0,7	L65	
960	2.0 i Turbo	B 204 FT Cat	140/190	09.1990	08.1994	RC 72 LS	A32	B26	0,7	L87	
	2.0 i Turbo	B 200 FT	105/143	09.1992	08.1997	RC 72 LS	A32	B26	0,7	L87	
	2.3 i Turbo	B 230 FT Cat	121/165	09.1990	08.1996	RC 62 LS	A6	B17	0,7	L65	
	2.3 i Turbo	B 230 GK - GT	104-125/141-170	09.1991	08.1997	RC 62 LS	A6	B17	0,7	L65	
	2.5 i 24V	B 6254 F - G Cat	125/170	08.1994	08.1997	RFC 52 LS	A3	B16	0,8	F54	
	2.8 i V6	B 280 E - F	110-125/150-170	09.1990	08.1991	RC 72 LJS	A88		0,7	J87	
	2.9 i V6 24V	B 6304 FS - GS Cat	135-150/184-204	09.1990	07.1998	RFC 52 LS	A3	B16	0,8	F54	
340-360	1.1 DL, GL	B 110 E			12.1980	C 32 S	A8		0,7	N43	
	1.3 DL, GL	B 130 E			12.1980	C 32 S	A8		0,7	N43	
	1.4 DL, GL	B 14 Renault	47/64	02.1976	09.1978	C 42 S	A12	B7	0,7	N43	
	1.4 DL, GL	B 14 Renault	47-53/64-72	02.1976	09.1978	RC 62 LS	A6	B17	0,7	L65	
	1.7	B 17 2 K	59/80	09.1986	07.1991	RC 32 LS	A49	B19	0,75	L3	
		Fgst.Nr. 241000 -->									
	1.7 DL, GL	B 17 2K	59/80	07.1985	08.1986	RC 62 LS	A6	B17	0,7	L65	
	1.7 DL, GL	B 172 KD		09.1986	07.1991	RC 52 LS	A9	B20	0,7	L65	
	1.7 DL, GL	B 17 2K	59/80	09.1986	07.1991	RC 52 LS	A9	B20	0,7	L65	
	2.0	B 200 K	72-76/98-103	08.1984	07.1988	RC 62 LS	A6	B17	0,7	L65	
	2.0 i	B 200 F	86/117			RC 72 LS	A32	B26	0,7	L87	
	2.0 i	B 200 E	86/117	08.1984	07.1988	RC 72 LS	A32	B26	0,7	L87	
	2.0 Sport	B 19 A	65-68-90/88-92-122	08.1979	07.1984	C 62 LS	A4	B5	0,7	L65	
440 K	2.0	B 20 F	81/110	08.1992	07.1995	RC 62 LS	A6	B17	0,7	L65	
	2.0	B 20 F	80/109	08.1993	07.1996	RC 62 LS	A6	B17	0,7	L65	
460 L	2.0	B 20 F	81/110	08.1992	07.1995	RC 62 LS	A6	B17	0,7	L65	

(f) Available until end of stock

(a) 30 000 km

(b) 60 000 km

(c) Grey sticker on ignition coil

(d) Green sticker on ignition coil

(e) Hex 21 mm

(f) Hex 16 mm

(g) Recommended for cold weather

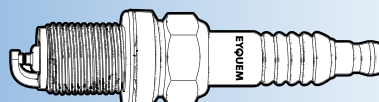

EYQUEM

**Box**
10**Blister**
4**F3****VOLVO**

	2.0	B 20 F	80/109	08.1993	07.1996	RC 62 LS	A6	B17	0,7	L65
480 E	1.7	B 18 F	70/95	08.1987	07.1989	RC 32 LS	A49	B19	0,75	L3
	2.0	B 20 F	81/110	08.1992	09.1995	RC 62 LS	A6	B17	0,7	L65
C	202 : 2.0	B 20 A		03.1975	12.1991	C 42 S	A12	B7	0,7	N43
	303, 304, 306 : 3.0	B 30 A	86/117	10.1974	12.1991	C 62 S	A55		0,7	
C30	1.6	B 4164S3	74/101	10.2006		RC 62 HJS6	A182	B57	1,3	
	1.8	B4184S11	92/125	10.2006	07.2010	RN 62 LJZDP6	A503		1,3	
	1.8 FlexFuel	B4184S8	92/125	01.2007	07.2010	RN 62 LJZDP6	A503		1,3	
	2.0	B4204S3	107/145	10.2006		RN 62 LJZDP6	A503		1,3	
	2.0 FlexFuel	B4204S4	107/145	01.2010		RN 62 LJZDP6	A503		1,3	
C70	2.0 i	B 5202 S - F Cat	93-105/126-143	01.1997		RFC 52 LS3	A66		1,2	
	2.0 i 20V	B 5204 F - S Cat	105/143	01.1997		RFC 52 LS3	A66		1,2	
	2.0 i 20V Turbo	B 5204 T	132-166/180-226	01.1997		RFN 58 LZ (b)	A7	B28	0,8	F54
	2.0 i 20V Turbo	B 5204 T	132-166/180-226	01.1997		RFN 58 LZ3A (g)	A515		0,8	
	2.3 i 20V	B 5234 S	120/163	01.1999		RFC 52 LS3	A66		1,2	
	2.4 i 20V	B 5244 S	103-125/140-170	01.1999		RFC 52 LS3	A66		1,2	
	2.5 Coupé		121/165	03.1999	09.2002	RFC 52 LS	A3	B16	0,8	F54
	2.5 i	B 5252 S Cat	106/144	01.1997	03.2000	RFC 52 LS3	A66		1,2	
	2.5 i 20V	B 5254 F - S Cat	125/170	01.1997		RFC 52 LS3	A66		1,2	
S40	1.6 i 16V	B 4164 S	77/105	06.1996	08.1999	RFC 52 LS3	A66		1,2	
	1.6 i 16V	B 4164 F	77/105	06.1996		RFC 52 LS3	A66		1,2	
	1.6 i 16V	B 4164 S2	80/109	03.1999		RFC 52 LS3	A66		1,2	
	1.8 i 16V	B 4184 S	85/115	09.1995		RFC 52 LS3	A66		1,2	
	1.8 i 16V Optimum	B 4184 SM	92/125	09.1995		RFC 52 LS3	A66		1,2	
	2.0 i 16V	B 4204 S	103/140	09.1995		RFC 52 LS3	A66		1,2	
S40 II	1.6	B 41S3	74/101	01.2005		RC 62 HJS6	A182	B57	1,3	
	1.8	B4184S11	92/125	04.2004	07.2010	RN 62 LJZDP6	A503		1,3	
	1.8 FlexFuel	B4184S8	92/125	01.2006	07.2010	RN 62 LJZDP6	A503		1,3	
	2.0	B4204S3	107/145	10.2006		RN 62 LJZDP6	A503		1,3	
	2.0 FlexFuel	B4204S4	107/145	10.2006	06.2008	RN 62 LJZDP6	A503		1,3	
S60	2.4	B 5244 S2	103/140	11.2000		RFC 52 LS3	A66		1,2	
S70	2.0 i	B 5202 F - S Cat	93-105/126-143	01.1997		RFC 52 LS3	A66		1,2	
	2.0 i 20V	B 5204 F - S Cat	105/143	01.1997		RFC 52 LS3	A66		1,2	
	2.0 i 20V Turbo	B 5204 T	132-166/180-226	01.1997		RFN 58 LZ (b)	A7	B28	0,8	F54
	2.0 i 20V Turbo	B 5204 T	132-166/180-226	01.1997		RFN 58 LZ3A (g)	A515		0,8	
	2.3 i 20V	B 5234 S	120/163	01.1999		RFC 52 LS3	A66		1,2	
	2.4 i 20V	B 5244 S	103-125/140-170	01.1999		RFC 52 LS3	A66		1,2	
	2.5 i	B 5252 S Cat	106/144	01.1997	03.2000	RFC 52 LS3	A66		1,2	
	2.5 i 20V	B 5254 F - S Cat	121-125/165-170	01.1997		RFC 52 LS3	A66		1,2	
S80	2.4 i	B 6244 F	120/163	01.1997		RFN 58 LZ (b)	A7	B28	0,8	F54
	2.4 i	B 6244 F	120/163	01.1997		RFN 58 LZ3A (g)	A515		0,8	
	2.4 i 20V	B 5244 S	103-125/140-170			RFC 52 LS3	A66		1,2	
	2.9 i V6 24V	B 6304 S	150/204	06.1998		RFC 52 LS3	A66		1,2	
S90	2.5 i 24V	B 6254 F - G Cat	125/170	01.1997		RFN 58 LZ (b)	A7	B28	0,8	F54
	2.5 i 24V	B 6254 F - G Cat	125/170	01.1997		RFN 58 LZ3A (g)	A515		0,8	
	2.9 i V6 24V	B 6304 S - F - G	132-150/180-204	01.1997		RFN 58 LZ (b)	A7	B28	0,8	F54
	2.9 i V6 24V	B 6304 S - F - G	132-150/180-204	01.1997		RFN 58 LZ3A (g)	A515		0,8	
SAMFENG	2.3 i	B 230 GS	114/155	08.1994	07.1997	RC 62 LS	A6	B17	0,8	L65
V40	1.6 i 16V	B 4164 F - S	77/105	06.1996		RFC 52 LS3	A66		1,2	
	1.6 i 16V	B 4164 S2	80/109	03.1999		RFC 52 LS3	A66		1,2	
	1.8 i 16V	B 4184 S	85-92/115-125	09.1995		RFC 52 LS3	A66		1,2	
	2.0 i 16V	B 4204 S	103/140	09.1995		RFC 52 LS3	A66		1,2	
V50	1.6	B4164S3	74/101	01.2005		RC 62 HJS6	A182	B57	1,3	
	1.8	B 4184 S11	92/125	04.2004		RFC 52 LS3	A66		1,2	
	1.8 FlexFuel	B4184S8	92/125	01.2005	07.2010	RN 62 LJZDP6	A503		1,3	
	2.0	B4204S3	107/145	10.2006	12.2012	RN 62 LJZDP6	A503		1,3	
	2.0 FlexFuel	B4204S4	107/145	01.2010	12.2012	RN 62 LJZDP6	A503		1,3	
V70	2.0 i	B 5202 F - S Cat	93-105/126-143	01.1997		RFC 52 LS3	A66		1,2	
	2.0 i 20V	B 5204 F - S Cat	105/143	01.1997		RFC 52 LS3	A66		1,2	
	2.0 i 20V Turbo	B 5204 T	132-166/180-226	01.1997		RFN 58 LZ (b)	A7	B28	0,8	F54
	2.0 i 20V Turbo	B 5204 T	132-166/180-226	01.1997		RFN 58 LZ3A (g)	A515		0,8	
	2.3 i 20V	B 5234 S	120/163	01.1999		RFC 52 LS3	A66		1,2	
	2.4 i 20V	B 5244 S	103-125/140-170	01.1999		RFC 52 LS3	A66		1,2	
	2.5 i	B 5252 S Cat	106/144	01.1997	03.2000	RFC 52 LS3	A66		1,2	
	2.5 i 20V	B 5254 F - S Cat	121-125/165-170	01.1997		RFC 52 LS3	A66		1,2	

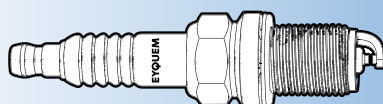

(1) Available until end of stock

(a) 30 000 km

(b) 60 000 km

(c) Grey sticker on ignition coil

(d) Green sticker on ignition coil

(e) Hex 21 mm

(f) Hex 16 mm

(g) Recommended for cold weather



kW/HP



Box 10
Blister 4



F3-1

VOLVO

V90	2.5 i 24V	B 6254 F - G Cat	125/170	01.1997		RFN 58 LZ (b)	A7	B28	0,8	F54
	2.5 i 24V	B 6254 F - G Cat	125/170	01.1997		RFN 58 LZ3A (g)	A515		0,8	
	2.9 i V6 24V	B 6304 S - F - G	132-150/180-204	01.1997		RFN 58 LZ (b)	A7	B28	0,8	F54
	2.9 i V6 24V	B 6304 S - F - G	132-150/180-204	01.1997		RFN 58 LZ3A (g)	A515		0,8	

WARTBURG

353	1.0			07.1971	09.1989	C 42 S	A12	B7	0,6	N43
	1.0 W		37/50	01.1978	12.1990	C 42 S	A12	B7	0,6	N43
	1.3	Mot. VW	43/58	09.1988	05.1991	C 62 LS	A4	B5	0,7	L65

YULON (YUE LOONG)

101 Feeling	1.6	CA16S	65/88	01.1988		RFC 52 LS5	A26	B24	1,1	F54-5
	1.8	CA18S	72/98	01.1988		RFC 52 LS5	A26	B24	1,1	F54-5

ZASTAVA (YUGO)

YUGO	101 : 1.1			06.1972	12.1993	RC 62 LS	A6	B17	0,7	L65
	101 : 1.3 1300			06.1972	12.1993	RC 62 LS	A6	B17	0,7	L65
	101 : 1.4 125 PZ			06.1972	12.1993	RC 62 LS	A6	B17	0,7	L65
	45 : 0.9		33/45	04.1980	12.1993	RC 52 LS	A9	B20	0,7	L65
	55 : 1.1		41-44/56-60	04.1980	12.1993	RC 52 LS	A9	B20	0,7	L65
	60 ie : 1.1 ie		41-44/56-60	04.1980	12.1993	RC 52 LS	A9	B20	0,7	L65
	65 : 1.3, Cabrio		47-48/64-65	05.1985	12.1993	RC 52 LS	A9	B20	0,7	L65
	65 ie : 1.3 ie, Cabrio		47-48/64-65	05.1985	12.1993	RC 52 LS	A9	B20	0,7	L65
	750 : 0.75				12.1978	RC 42 S	A69	B23	0,7	N43
	750 : 0.75 S			01.1978	12.1980	RC 62 LS	A6	B17	0,7	L65
	Sana			06.1972	12.1993	RC 62 LS	A6	B17	0,7	L65
YUGO FLORIDA	1.3		50-52-62/68-71-84	10.1988	12.1993	RC 52 LS	A9	B20	0,7	L65
	1.4		50-52-62/68-71-84	10.1988	12.1993	RC 52 LS	A9	B20	0,7	L65
	1.6		50-52-62/68-71-84	10.1988	12.1993	RC 52 LS	A9	B20	0,7	L65

ZAZ

966 / 968	1.0		28-33/38-45	01.1974	05.1990	C 62 S	A55		0,6	
	1.2		28-33/38-45	01.1974	05.1990	C 62 S	A55		0,6	
DANA	1105 : 1.1		39/53	01.1995		C 62 LS	A4	B5	0,7	L65
TAVRIJA	1102, 1105 : 0.9, 1.1, 1.3			01.1989		C 62 LS	A4	B5	0,7	L65

(1) Available until end of stock

(a) 30 000 km

(b) 60 000 km

(c) Grey sticker on ignition coil

(d) Green sticker on ignition coil

(e) Hex 21 mm

(f) Hex 16 mm

(g) Recommended for

cold weather



EYQUEM

APPLICATIONS BY SPARK PLUG APPLICATIONS PAR BOUGIE

VERWENDUNG NACH FAHRZEUGTYP
APLICACIONES POR VEHÍCULO



253

EYQUEM



Short ref



805 LJSP	A96	RENAULT, VENTURI
805 LP	A79	LAMBORGHINI, RENAULT
883 LJP	A87	CITROËN, RENAULT
C 30 LS	A47	BERTONE, BMW
C 32	A33	VOLKSWAGEN
C 32 LS	A31	NISSAN, VOLKSWAGEN (MEX)
C 32 S	A8	LAND ROVER, MG-ROVER, RENAULT, VOLVO
C 42 LJS3	A77	RENAULT
C 42 S	A12	ARO, CITROËN, DACIA, FIAT, GAZ, MOSKVITCH, RENAULT, SKODA, SUZUKI, TAZ, VOLVO, WARTBURG
C 52 LJS	A23	AUSTIN - MORRIS, LEYLAND-FREIGHT ROVER, MERCEDES, PEUGEOT, RENAULT
C 52 LS	A1	ALFA ROMEO, ARO, AUDI, BMW, CITROËN, DAIMLER LTD, HINDUSTAN, HYUNDAI, ISUZU, JAGUAR, LAND ROVER, MASERATI, MAZDA, MERCEDES, MITSUBISHI, NISSAN, OTOSAN, PEUGEOT, PROTON, SANTANA, SIMCA (Chrysler), SUZUKI, TALBOT, TOYOTA, TRIUMPH, VOLKSWAGEN
C 52 LS3X	A28	ALFA ROMEO, AUDI, SEAT, VOLKSWAGEN
C 62	A20	CITROËN, PIAGGIO
C 62 LJS	A19	CITROËN, MERCEDES, PEUGEOT, RENAULT, ROVER, TALBOT, TRIUMPH
C 62 LS	A4	ALFA ROMEO, ALPINA, AUDI, AUSTIN - MORRIS, BMW, CITROËN, DAF, DAIHATSU, DAIMLER LTD, FIAT, FISSORE, FORD, FSO, GINETTA, HONDA, HYUNDAI, ISUZU, IVECO, KIA, LADA (Shiguli), LANCIA, LAND ROVER, LEYLAND-DAF, LEYLAND-FREIGHT ROVER, MASERATI, MAZDA, MERCEDES, MITSUBISHI, MOSKVITCH, NISSAN, PEUGEOT, ROVER, SAAB, SEAT, SIMCA (Chrysler), SUBARU, SUZUKI, TALBOT, TOFAS, TOYOTA, TRABANT, VANDEN PLAS, VAUXHALL, VOLKSWAGEN, VOLVO, WARTBURG, ZAZ
C 62 LS3X	A13	ALFA ROMEO, AUDI, DAIHATSU, FSO, LANCIA, NISSAN, PEUGEOT, SEAT, TOYOTA, VOLKSWAGEN
C 62 S	A55	CITROËN, FIAT, SAAB, SKODA, TRABANT, VOLVO, ZAZ
C 72	A64	CITROËN, PIAGGIO
C 72 L	A106	ALFA ROMEO
C72 LS	A30	ALFA ROMEO, AUDI, MERCEDES, VOLKSWAGEN, VOLVO
C 72 LJS	A22	CITROËN, LEYLAND-FREIGHT ROVER, OLCIT, OPEL, PANTHER, PEUGEOT, RENAULT, TALBOT
C 72 LS3X	A63	ALFA ROMEO, AUDI, FIAT, LANCIA, PORSCHE, VOLKSWAGEN
C 82 L	A105	JAGUAR, MASERATI
C 82 LJS	A52	ALPINE, JAGUAR, MERCEDES, PEUGEOT, RENAULT
C 82 LS	A40	ALFA ROMEO, AUDI, DINO, FERRARI, FIAT, FSO, LAMBORGHINI, LANCIA, MASERATI, PEUGEOT, PORSCHE, RENAULT, SAAB, SIMCA (Chrysler), TALBOT, TVR, VOLKSWAGEN
C 82 LS3X	A92	PIAGGIO, VOLKSWAGEN
FC 42 LS	A15	DAEWOO, MERCEDES, PUCH, RENAULT, SAAB, SKODA, SSANGYONG
FC 52 LS	A2	MERCEDES, NISSAN, PROTON, ROVER
FC 52 LZWR	A543	MERCEDES
FC 58 LS	A14	OPEL, ROVER
FC 62 LS	A43	CITROËN, SAAB, SKODA
FC 62 LS3	A82	RENAULT
FC 62 LS3X	A57	ALFA ROMEO, AUDI, NISSAN, RENAULT, SEAT, VOLKSWAGEN
FC 62 LSDPR	A522	AUDI, SEAT, SKODA, VOLKSWAGEN



Short ref



FN 42 LZDPR5	A195	MERCEDES
FN 52 LS	A41	VAUXHALL
FN 58 LZKFR	A183	SEAT, SKODA, VOLKSWAGEN
FN 58 LZKFR 5	A521	SEAT, SKODA, VOLKSWAGEN
FN 58 LZDPR	A198	ALFA, AUDI, LANCIA, ROVER, SEAT, SKODA, SUBARU, VOLKSWAGEN
FN 62 LZFDPR2A	A192	AUDI, VOLKSWAGEN
FN 68 LZDPR	A523	AUDI, SEAT, SKODA, VOLKSWAGEN
FN 68 LZPFRS	A548	AUDI, SEAT, SKODA, VOLKSWAGEN
FN 72 HZIPRSO	A537	AUDI-SEAT-SKODA-VW
FN 72 LZPFRS	A551	VW
RC 22 LJZ7	A129	FORD
RC 22 LZ	A131	TRIUMPH
RC 30 LS	A109	BENTLEY, CHRYSLER, DODGE, JEEP, PLYMOUTH, PONTIAC, RELIANT, ROVER
RC 32 LS	A49	BEDFORD, BENTLEY, BRISTOL, CHRYSLER, DAEWOO, DODGE, JAGUAR, LADA (Shiguli), LAND ROVER, LEYLAND-DAF, LEYLAND-FREIGHT ROVER, MG-ROVER, PANTHER, PANTHER, RENAULT, ROLLS-ROYCE, SEAT, TOYOTA, TVR, VOLKSWAGEN, VOLVO
RC 32 LS5	A110	BENTLEY, CHEVROLET, CHRYSLER, DAEWOO, DODGE, HYUNDAI, JEEP EAGLE, MERCURY, MITSUBISHI, NISSAN, PLYMOUTH, TOYOTA
RC 42 HJS3E5	A179	FIAT, OPEL
RC 42 S	A69	BEDFORD, DACIA, DAEWOO, OPEL, VAUXHALL, ZASTAVA (YUGO)
RC 42 JS5	A138	CHEVROLET, PONTIAC
RC 52 LJS	A62	AUDI, CITROËN, FORD, FREIGHT ROVER, JEEP EAGLE, MERCURY, RENAULT, ROVER, TVR
RC 52 LJS4E	A155	AUDI
RC 52 LJS5	A74	BEDFORD, FORD (USA), FORD, MAZDA, OPEL
RC 52 LS	A9	ASIA, CHRYSLER, DAEWOO, DAIHATSU, DODGE, FIAT, FREIGHT ROVER, HOLDEN, HONDA, HYUNDAI, INNOCENTI, KIA, LADA (Shiguli), LAND ROVER, MAZDA, MITSUBISHI, MOSKVITCH, NISSAN, OPEL, PIAGGIO, PORSCHE, PREMIER, RENAULT, ROVER, SANTANA, SEAT, SUZUKI, TOYOTA, VAUXHALL, VOLKSWAGEN, VOLVO, ZASTAVA (YUGO)
RC 52 LS5	A36	BEDFORD, CHRYSLER, DAEWOO, DAIHATSU, GEO, HINDUSTAN, HOLDEN, HONDA, HYUNDAI, ISUZU, KIA, MAZDA, MITSUBISHI, NISSAN, OPEL, PLYMOUTH, PROTON
RC 52 LZ3EX	A35	AUDI, SEAT, VOLKSWAGEN
RC 52 LZ	A67	BERTONE, BMW
RC 58 LZ3EX	A34	AUDI, LANCIA, SEAT, SKODA, VOLKSWAGEN
RC 62 HJS6	A182	FORD, MAZDA
RC 62 HJSP	A181	FORD, MAZDA
RC 62 LJS	A68	CHEVROLET
RC 62 LJS5	A103	AUDI, FORD, VOLVO





Short ref



RC 62 LS	A6	AC, ALFA ROMEO, ASTON-MARTIN, AUTOBIANCHI, BEDFORD, BMW, BUICK, CHEVROLET, CHRYSLER, CITROËN, DAEWOO, DAIHATSU, DODGE, FIAT, FORD, FREIGHT ROVER, FSO, GAZ, HILLMAN, HOLDEN, HONDA, HYUNDAI, INNOCENTI, ISUZU, JAGUAR, JEEP, JEEP EAGLE, KIA, LADA (Shiguli), LANCIA, LAND ROVER, LOTUS, MASERATI, MAZDA, MG, MG-ROVER, MITSUBISHI, MORGAN, MOSKVITCH, MURAT, NISSAN, OPEL, PANTHER, PONTIAC, PORSCHE, PROTON, RELIANT, RENAULT, ROVER, SAAB, SANTANA, SEAT, STEYR (Steyr-Daimler-Puch AG), SUBARU, SUZUKI, TALBOT, TOYOTA, TRIUMPH, TVR, VAUXHALL, VOLKSWAGEN, VOLVO, ZASTAVA (YUGO)
RC 62 LS5	A24	AUSTIN - MORRIS, BEDFORD, DAIHATSU, HOLDEN, HONDA, HYUNDAI, INNOCENTI, ISUZU, KIA, LADA (Shiguli), MAZDA, MITSUBISHI, NISSAN, OPEL, PROTON, ROVER, SUBARU, SUZUKI, TOYOTA, VAUXHALL
RC 62 S	A95	ARO, FIAT, OPEL
RC 72	A93	
RC 82	A115	MOTORCYCLE
RC 72 L	A114	JAGUAR, MITSUBISHI
RC 72 LJS	A88	CITROËN, FORD, MAZDA, RENAULT, VOLVO
RC 72 LJS3	A80	DE LOREAN, LANCIA, PEUGEOT
RC 72 LS	A32	ALFA ROMEO, ASTON-MARTIN, AUSTIN - MORRIS, AUTOBIANCHI, BEDFORD, CATERHAM, DAIHATSU, FIAT, FISSORE, FORD, GINETTA, HILLMAN, INNOCENTI, ISUZU, JAGUAR, LANCIA, LAND ROVER, LOTUS, MG-ROVER, MITSUBISHI, MORGAN, MOSKVITCH, PORSCHE, RELIANT, RENAULT, ROVER, SAAB, SEAT, SUBARU, TALBOT, TATRA, TAZ, TOFAS, TOYOTA, TVR, VAUXHALL, VOLVO
RC 72 LS5	A116	MITSUBISHI, VAUXHALL
RC 82 L	A94	AUTOBIANCHI, CATERHAM, FORD, LANCIA, PORSCHE
RC 82 LS	A78	CATERHAM, FORD, LANCIA, LOTUS, MAZDA, MITSUBISHI, PORSCHE, VOLKSWAGEN (BR)
RFC 32 LZ5	A117	HONDA, ISUZU, JEEP, MAZDA, ROVER, SATURN
RFC 42 LS	A25	AUDI, CHRYSLER, DODGE, FIAT, JEEP EAGLE, JEEP, LANCIA, MAZDA, MERCURY, OLDSMOBILE, PEUGEOT, PONTIAC, SKODA, TOYOTA
RFC 42 LS5	A83	ACURA, BUICK, CHEVROLET, CHRYSLER, DAEWOO, DAIHATSU, DODGE, GEO, HYUNDAI, JEEP, KIA, MAZDA, MITSUBISHI, NISSAN, PLYMOUTH, PONTIAC, SAAB, SATURN, SUBARU, TOYOTA
RFC 42 LZ2E	A5	DAEWOO, HOLDEN, LADA (Shiguli), MERCEDES, OPEL, TOYOTA
RFC 42 LZ4E	A154	FORD, MERCEDES, OPEL, SEAT, VAUXHALL, VOLKSWAGEN
RFC 42 LZDP	A188	MAZDA
RFC 52 LS	A3	AUTOBIANCHI, CATERHAM, CHEVROLET, CHRYSLER, CITROËN, DAIHATSU, DAIMLER LTD, DODGE, FIAT, HYUNDAI, JAGUAR, JEEP, KIA, LANCIA, MAZDA, MORGAN, NISSAN, OPEL, PEUGEOT, RENAULT, ROVER, SAAB, SKODA, SUZUKI, TOYOTA, VOLVO
RFC 52 LS3	A66	RENAULT, TVR, VOLVO
RFC 52 LS5	A26	DAEWOO, DAIHATSU, FORD, HOLDEN, HONDA, HYUNDAI, ISUZU, JEEP, KIA, MAZDA, MERCURY, MG, MITSUBISHI, NISSAN, OPEL, PROTON, RENAULT, ROVER, SAAB, SUBARU, SUZUKI
RFC 52 LZ4E	A159	AUDI, VOLKSWAGEN
RFC 52 LZDP	A152	LEXUS, NISSAN, SAAB, TOYOTA
RFC 52 LZDP5	A149	ACURA, FORD, HOLDEN, HONDA, LOTUS, NISSAN, ROVER, SUBARU, TOYOTA



Short ref



RFC 52 LZDP6	A156	TOYOTA
RFC 52 LZE	A102	BMW
RFC 58 HZEDP5	A191	DAIHATSU, BMW, MCC, MITSUBISHI, OPEL, SMART, TOYOTA
RFC 58 LS	A18	CATERHAM, CHEVROLET, DAIMLER LTD, FORD, FSO, HYUNDAI, ISUZU, KIA, LAND ROVER, MAZDA, MG-ROVER, MITSUBISHI, NISSAN, OPEL, PANTHER, PORSCHE, RELIANT, ROVER, SUBARU, SUZUKI, TATRA
RFC 58 LS3	A16	CITROËN, PEUGEOT, RENAULT
RFC 58 LS5	A38	ACURA, DAEWOO, DAIHATSU, FORD, HOLDEN, HONDA, ISUZU, KIA, LADA (Shiguli), MAZDA, MITSUBISHI, NISSAN, OPEL, PROTON, RELIANT, ROVER, SAAB, SUBARU, SUZUKI, TOYOTA, VAUXHALL
RFC 58 LZ	A50	NISSAN, TOYOTA
RFC 58 LZ2	A54	CITROËN, DAIHATSU, FIAT, LANCIA, RENAULT, TOYOTA
RFC 58 LZ2E	A10	BERTONE, BMW, DACIA, DACIA, HOLDEN, LAND ROVER, LOTUS, MCC SMART, OPEL, PORSCHE, RENAULT, SAAB, SEAT, VAUXHALL, VOLKSWAGEN
RFC 58 LZ3EX	A58	AUDI, DAIHATSU, FIAT, LANCIA, MERCEDES, SEAT, SEAT, SKODA, VOLKSWAGEN
RFC 58 LZ5	A101	DAIHATSU, HOLDEN, NISSAN, TOYOTA
RFC 58 LZE5	A75	FORD (USA), FORD, HONDA, JEEP, KIA, MAZDA, OPEL, ROVER, TOYOTA, VAUXHALL
RFC 58 LZF5	A186	NISSAN
RFC 58 LZK	A11	CITROËN, DACIA, DAIHATSU, FIAT, HONDA, LANCIA, LOTUS, NISSAN, OPEL, PEUGEOT, PORSCHE, RENAULT, SEAT, VAUXHALL
RFC 58 LZP	A178	RENAULT
RFC 58 LZP4	A193	ALFA ROMEO, AUDI, BMW, ROVER, SAAB, SKODA, VOLKSWAGEN
RFC 58 LZDP	A99	RENAULT
RFC 62 LS	A48	CITROËN, FIAT, FORD, HYUNDAI, MORGAN, NISSAN, PANTHER, RENAULT, ROVER, SEAT, VOLKSWAGEN (BR)
RFC 62 LS3	A56	CITROËN, PEUGEOT, RENAULT
RFC 62 LS3X	A59	FIAT, LANCIA
RFC 62 LS5	A42	DAEWOO, DAIHATSU, FORD, HONDA, ISUZU, NISSAN
RFC 62 LSDP5	A507	FORD, HONDA, LEXUS, MITSUBISHI, NISSAN, OPEL, RENAULT, SUBARU, SUZUKI, TOYOTA, VAUXHALL
RFC 62 LS4GF6	A511	AUDI, SKODA, VW
RFC 62 LZ2	A150	AUDI, VOLKSWAGEN
RFC 62 LZ3EX	A86	AUDI, SEAT, VOLKSWAGEN (MEX), VOLKSWAGEN
RFC 82 LS	A76	ALFA ROMEO, ASTON-MARTIN, CATERHAM, FORD, JAGUAR, LANCIA, RENAULT, SAAB, SEAT
RFC 82 LS5	A65	SAAB
RFC 96 HS3	A196	CITROËN
RFN 42 HZP5	A512	NISSAN
RFN 42 HZDP5	A184	CITROËN, INFINITY, LANCIA, NISSAN, PEUGEOT, RENAULT
RFN 42 LZG	A532	ALFA, CHEVROLET, FIAT, OPEL
RFN 42 LZG5	A112	CHRYSLER, JEEP, TOYOTA
RFN 42 LZP	A194	FORD, SKODA
RFN 52 HZ	A157	CITROËN, FIAT, LANCIA, NISSAN, PEUGEOT, RENAULT
RFN 52 HZ3A	A100	CITROËN, FIAT, LANCIA, PEUGEOT
RFN 52 HZ5	A545	HYUNDAI, KIA, NISSAN
RFN 58 HZ	A158	CITROËN, NISSAN, PEUGEOT, TOYOTA
RFN 58 HZ3A	A516	CITROËN, NISSAN, PEUGEOT, TOYOTA
RFN 58 HZ 5	A534	CITROËN, DAIHATSU, MITSUBISHI, PEUGEOT, TOYOTA





Short ref



RFN 52 LZ	A27	CITROËN, DAEWOO, DAIHATSU, FIAT, LADA (Shiguli), LANCIA, NISSAN, OPEL, PEUGEOT, PORSCHE, RENAULT, VAUXHALL
RFN 52 LZDPF5	A153	AUDI, FORD, SEAT, SKODA, VOLKSWAGEN
RFN 58 LZ	A7	ALFA ROMEO, ASTON-MARTIN, AUTOBIANCHI, CATERHAM, CITROËN, DACIA, FIAT, FORD, FSO, LANCIA, LAND ROVER, MASERATI, OPEL, PEUGEOT, RELIANT, RENAULT, ROVER, SAAB, VAUXHALL, VOLVO
RFN 58 LZ3A	A515	ALFA ROMEO, ASTON-MARTIN, AUTOBIANCHI, CATERHAM, CITROËN, DACIA, FIAT, FORD, FSO, LANCIA, LAND ROVER, MASERATI, OPEL, PEUGEOT, RELIANT, RENAULT, ROVER, SAAB, VAUXHALL, VOLVO
RFN 58 LZDP	A519	OPEL, RENAULT, VAUXHALL
RFN 58 LZDP5	A187	HONDA, KIA, MITSUBISHI, NISSAN, SUBARU
RFN 58 LZDPE5	A539	BMW
RFN 62 HZDP	A504	CITROËN, FORD, MERCEDES, NISSAN, PEUGEOT, VOLVO
RFN 62 LZ	A71	ASTON-MARTIN, CITROËN, FIAT, FORD, LANCIA, LOTUS, PEUGEOT, VOLVO
RFN 62 LZDP5	A185	OPEL, SAAB, VAUXHALL
RKC 62 JS	A29	AC, FORD, FSO, OTOSAN, TVR
RN 22 HJSE6	A180	CHRYSLER, JEEP
RN 62 LJZDP6	A503	FORD
RN 62 LJZEDP6	A505	FORD, MAZDA
RTC 62 LSDP	A199	ALFA ROMEO
RWC 42 HSEW	A555	DACIA, NISSAN, RENAULT
RWC 52 HSK	A197	CITROËN, PEUGEOT, RENAULT, DACIA
RWC 58 HSE5DP	A528	NISSAN, RENAULT
RWC 58 HSEW	A530	DACIA, RENAULT
RWC 62 HSDPS	A520	RENAULT
RWN 42 HSIPS	A542	DACIA, RENAULT, NISSAN
RWN 42 HSIPW	A544	TOYOTA
RXC 42 HSEDP 2A	A513	CITROËN, PEUGEOT
RXC 42 HZGP5	A506	CITROËN, PEUGEOT
RXC 58 HSEDP	A500	CITROËN, PEUGEOT
RXC 62 HSEDP	A189	BMW, MINI,
RXN 62 HSDP	A525	CITROËN, MINI, PEUGEOT
RXN 62 HSEP	A514	MINI
RXN 72 HSDPFT	A540	BMW
RXN 72 HSIPFS	A541	CITROËN, PEUGEOT
RXN 72 HSIPFSO	A550	BMW, MINI
RZC 58 HST	A533	HYUNDAI, KIA
RZC 62 HSET	A526	HYUNDAI, KIA
RZC 58 LS	A190	FIAT, LANCIA, SUZUKI
RZC 62 LS	A524	CHEVROLET
RZC 62 LS 5	A509	DAIHATSU, FIAT, FORD, LANCIA, SUZUKI
RZC 62 LSDP5K	A518	OPEL
RZC 62 LSE	A510	ALFA, FIAT, LANCIA
RZC 68 HS2	A552	SMART
RZC 72 LS	A508	FIAT, FORD
RZC 82 HSDPS	A536	FIAT
RZC 82 LSDPT	A535	ALFA-ROMEO, FIAT, LANCIA
RZN 32 HSWDP	A531	CITROËN, PEUGEOT
ZN 62 LSDPFRSO	A538	AUDI-SEAT-SKODA-VW
ZN 68 HSTDPR	A527	MERCEDES



Short ref

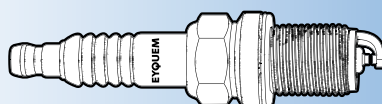

CROSS REFERENCES CORRESPONDANCES

UMSCHLÜSSELUNGEN
REFERENCIAS CRUZADAS



257

EYQUEM

**EYQUEM****ACDELCO**

44	500 C
2500	C 82 LS
2502	C 82 LJS
2503	C 82 LS 3X
3500	C 72 LS 3X
3501	C 72 LJS
4500	C 62 LS 3X
4501	C 62 LJS
4502	C 62
4503	FC 62 LS 3X
4504	FC 62 LS
5500	FC 58 LS
6500	C 52 LS 3X
6501	C 52 LJS
6502	C 52 LS
6503	FN 52 LS
6602	RC 52 LJS
7500	FC 42 LS
7501	C 42 LJS 3
7502	C 42 S
8500	C 32
8501	C 32 LS
8502	C 32 S
9500	C 30 LS
41 XLS	C 82 LS
41F	C 82
42 F	C 62
42 FS	C 62 S
42 LTS	755 LJS
42 XL	C 72 L
42 XLS	C 62 LS
422 Z	C 32
43 FS	C 32 S
438 XLS	C 92 LS
44 NS	C 30 LS
44 XLS	C 32 LS
445 Z	C 82
44F	C 32
45 NS	C 32 LS
45 XLS	C 32 LS
45F	C 32
C 42 CFS	C 42 S
C 42 XLS	C 52 LS
C45	500 C
CFR 2 CLS	RFC 58 LS
CFR 3 CLS	RFC 52 LS
CR 41 CXLS	RC 82 LS
CR 42 CLTS	RC 62 LJS
CR 42 N	RC 72 L
CR 42 XLSX	RC 62 LS 5
CR 425 FS	RC 42 S
CR 43 TS	RC 42 JS
CR 44 NS	RC 72 LS
FR 1 LS	RFC 58 LS
FR 2 LS	RFC 42 LS
LM 49	R 202 CT
M 42 FF	C 42
N 700	C 62 S
N 701	C 62
N 702	C 82
N 705	805 LP
N 802	805 LJSP
R 2600	RFC 82 LS 5
R 2601	RFC 82 LS
R 2602	RC 82 LS 5

**EYQUEM****ACDELCO**

R 3600	RC 72 LS
R 3601	RC 72 LS 5
R 3602	RC 72 LJS
R 3603	RC 72 LJS 5
R 41 XL	RC 82 L
R 41 XLS	RC 82 LS
R 41CF	RC 82
R 42 XLS	RC 62 LS
R 43 CXLS	RC 32 LS
R 43 TS	RC 42 JS 5
R 43 XLS	RC 52 LS
R 44 LTS6	RC 22 LJZ 7
R 44 XLS	RC 22 LZ
R 45 NS	RC 30 LS
R 4600	RC 62 LJS 5
R 4601	RFC 62 LS 5
R 4602	RFC 62 LS
R 4604	RFC 62 LS 3X
R 4605	RC 62 S
R 4606	RFN 62 LZ
R 4607	RFC 62 LZ 3EX
R 5601	RFC 58 LS 3
R 5602	RFC 58 LZ 2E
R 5603	RFC 58 LZ 2
R 5604	RFC 58 LS 5
R 5605	RFN 58 LZ
R 5605	RFN 58 LZ 3A
R 5606	RFC 58 LZ 3EX
R 5607	RC 58 LZ 3EX
R 5608	RFC 58 LZ
R 5609	RFC 58 LZ 5
R 5610	RFC 58 LZE 5
R 6600	RC 52 LZE
R 6601	RFC 52 LZE
R 6603	RC 52 LJS 5
R 6604	RFC 52 LS 3
R 6605	RFC 52 LS 5
R 6606	RC 52 LS 5
R 6607	RC 52 LZ 3EX
R 6609	RFN 52 LZ
R 6612	RFN 52 HZ
R 7600	RFC 42 LS
R 7601	RFC 42 LS 5
R 7602	RFC 42 LZ 2E
R 7603	RFN 42 LZG 5
R 8600	RC 32 LS
R 8601	RC 32 LS 5
R 8602	RFC 32 LZ 5
R 9600	RC 30 LS
S 41 FR	RC 82
S 42 F	C 72
S 42 FR	RC 72

ALFA ROMEO

46521529	RFC 58 LZP 4
46521530	RTC 62 LSDP
46521530	RTC 62 LSDP
60569957	FN 58 LZDPR
60579903	FN 58 LZDPR
60599495	RTC 62 LSDP
60599495	RTC 62 LSDP
60810689	FN 58 LZDPR
962 800 028 0	RFC 58 LZ 2E

**EYQUEM****AUDI**

03C 905 601 A	FN 72LZIPFRS
03C 905 601 B	FN 72LZIPFRS
03F 905 600 A	FN 68 LZIPFRS
04E 905 601	ZN 62 LSDPFRSO
04E 905 612	ZN 62 LSDPFRSO
04E 905 612 C	ZN 62 LSDPFRSO
101 905 626	FC 62 LSDPR
101 000 054 AC	RFC 52 LZ 4E
06K 905 601 B	FN 72 HZIPRSO
06K 905 611 C	FN 72 HZIPRSO

AUTOLITE

53	C 62 LS
54	C 32 LS
62	RC 72 LS
63	RC 62 LS
64	RC 52 LS
65	RC 52 LS 5
103	RC 72 LJS
274	C 42 S
275	C 32 S
284	RC 42 S
294	500 C
294	C 42
393	C 72 L
402	RC 82 L
411	C 82
413	C 62
414	C 42
415	C 32
416	C 32
425	C 32
458	R 202 CT
664	RC 42 JS 5
724	RC 42 JS
945	RC 22 LZ
2614	C 82 L
2634	C 72
2635	C 72
2653	C 72
2795	RTC 72
3462	RC 72 L
3922	RFC 62 LS
3923	RFC 52 LS
3924	RFC 42 LS
4092	RC 82
4203	RTC 72
5224	RFC 32 LZ 5
8922	RFC 58 LZ 2E
8923	RFC 42 LZ 2E
9061	C 82 LS 3X
9063	C 62 LS 3X
9064	C 52 LS 3X
9923	RFC 58 LZ 3EX

BERU

0 001 245 901	ZN 68 HSTDPR
0 001 325 701	C 32 LS
0 001 325 704	C 32 LS
0 001 330 112	RC 52 LZ 3EX
0 001 330 113	RC 52 LZ 3EX
0 001 330 702	C 52 LS
0 001 330 707	FC 42 LS
0 001 330 709	C 52 LS 3X
0 001 330 713	C 52 LS

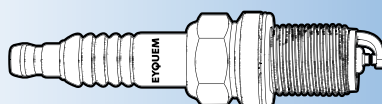

**EYQUEM****BERU**

0 001 330 717	RFC 52 LZE
0 001 330 718	RC 52 LZE
0 001 330 725	FC 42 LS
0 001 330 729	RFC 58 LS
0 001 330 731	FC 42 LS
0 001 330 780	FC 52 LZWR
0 001 330 905	FN 42 LZDPR 5
0 001 335 107	RFC 58 LZ 3EX
0 001 335 108	RC 58 LZ 3EX
0 001 335 702	C 62 LS
0 001 335 709	C 62 LS 3X
0 001 335 714	C 62 LS
0 001 335 721	FC 58 LS
0 001 335 725	FC 52 LS
0 001 335 732	RFC 58 LZ 2E
0 001 335 737	C 62 LS
0 001 335 742	FN 58 LZKFR
0 001 335 789	FN 58 LZKFR 5
0 001 335 911	RFN 52 LZDPF 5
0 001 335 914	FN 58 LZDPR
0 001 340 103	RFC 62 LZ 3EX
0 001 340 702	C 72 LS
0 001 340 704	C 72 LS 3X
0 001 340 706	RFC 62 LS 3X
0 001 340 707	C 72 LS
0 001 340 716	FC 62 LS
0 001 340 717	FC 62 LS 3X
0 001 340 717	RFC 62 LS 3X
0 001 340 723	FC 62 LS
0 001 340 910	FN 62 LZFDPR 2A
0 001 340 917	FC 62 LSDPR
0 001 345 702	C 82 LS
0 001 345 704	C 82 LS 3X
0 001 345 711	C 82 LS
0 001 345 720	RFC 82 LS
0 001 345 914	FN 68 LZDPR
0 001 345 915	FN 72 HZIPRSO
0 001 350 903	805 LP
0 001 355 700	C 82 L
0 001 400 701	200
0 001 430 700	C 32 S
0 001 430 701	C 32
0 001 435 700	C 42 S
0 001 435 705	C 42
0 001 440 700	C 62 S
0 001 445 702	C 62
0 001 450 702	C 72
0 001 455 702	C 82
0 001 455 702	RC 82
0 001 630 700	C 42 LJS 3
0 001 635 700	C 52 LJS
0 001 635 700	C 62 LJS
0 001 635 709	C 52 LJS
0 001 635 709	C 62 LJS
0 001 640 700	C 72 LJS
0 001 640 704	C 72 LJS
0 001 645 700	C 82 LJS
0 001 645 703	C 82 LJS
0 001 735 700	RKC 62 JS
0 001 740 700	RKC 62 JS
0 002 140 900	RTC 62 LSDP
0 002 140 900	RTC 62 LSDP
0 002 150 700	RTC 72
0 002 230 300	RWC 52 HSK
0 002 230 900	RXC 42 HZGP 5

**EYQUEM****BERU**

0 002 230 901	RXC 42 HSEDP 2A
0 002 235 700	RZC 58 LS
0 002 235 719	RFN 58 HZ
0 002 235 719	RFN 58 HZ 3A
0 002 235 901	RXC 58 HSEDP
0 002 235 905	RWC 58 HSE5DP
0 002 240 701	RZC 62 LSE
0 002 240 702	RZC 62 LS 5
0 002 240 707	RZC 62 LS
0 002 240 902	RXC 62 HSEDP
0 002 240 907	RXN 62 HSEP
0 002 240 910	RWC 62 HSDPS
0 002 240 911	RXN 62 HSDP
0 002 240 913	RZC 62 LSDP 5K
0 002 245 703	RZC 68 HS2
0 002 245 704	RZC 72 LS
0 002 250 900	RZC 82 LSDPT
0 002 250 901	RZC 82 HSDPS
0 002 325 700	RC 32 LS
0 002 330 102	RFC 42 LZ 4E
0 002 330 203	RFN 42 LZG 5
0 002 330 204	RFC 58 LZ 5
0 002 330 701	RC 52 LS
0 002 330 702	RC 52 LS 5
0 002 330 703	RFC 42 LS
0 002 330 704	RFC 42 LS 5
0 002 330 708	RFC 52 LS 5
0 002 330 709	RC 52 LS
0 002 330 710	RFC 42 LZ 2E
0 002 330 716	RFN 52 HZ
0 002 330 794	RFN 42 LZG
0 002 330 795	RFC 42 LZ 2E
0 002 330 796	RFN 52 HZ 3A
0 002 330 904	RFN 42 HZDP 5
0 002 330 905	RFN 42 LZP
0 002 330 918	RFC 42 LZDP
0 002 330 926	RFN 42 HZP 5
0 002 335 100	RFC 58 LS 3
0 002 335 104	RFC 52 LZ 4E
0 002 335 131	RFC 52 LZ 4E
0 002 335 500	RFC 58 LZ 2E
0 002 335 503	RFC 58 LZ 2E
0 002 335 600	L65
0 002 335 601	F54
0 002 335 701	RC 62 LS
0 002 335 706	RC 62 LS 5
0 002 335 707	RFC 52 LS
0 002 335 708	RFC 58 LS 5
0 002 335 709	RFC 58 LZ 2
0 002 335 712	RFC 58 LZ
0 002 335 714	RFC 58 LZ 5
0 002 335 717	RFN 58 LZ
0 002 335 717	RFN 58 LZ 3A
0 002 335 902	RFC 52 LZDP 5
0 002 335 903	RFC 52 LZDP 6
0 002 335 904	RFC 52 LZDP
0 002 335 911	RFC 58 LZP 4
0 002 335 912	RFC 58 LZDP
0 002 335 912	RFC 58 LZP
0 002 335 914	RFN 58 LZDP 5
0 002 335 915	RFC 58 HZEDP 5
0 002 335 935	RFN 58 LZDPE5
0 002 335 938	FN 42 LZDPR 5
0 002 335 946	RFN 58 LZDP
0 002 336 715	RFC 58 LZP 5

**EYQUEM****BERU**

0 002 336 724	RFC 58 LZK
0 002 336 734	RFN 52 HZ5
0 002 336 738	RFN 58 HZ 5
0 002 340 102	RFC 62 LZ 2
0 002 340 117	RFC 52 LS 3
0 002 340 123	RFC 62 LS4GF 6
0 002 340 701	RC 72 LS
0 002 340 702	RFC 62 LS
0 002 340 703	RC 72 LS 5
0 002 340 704	RFC 62 LS 5
0 002 340 905	RFN 62 LZDP 5
0 002 340 906	RFN 62 HZDP
0 002 340 908	RFC 62 LSDP 5
0 002 345 600	L87
0 002 345 601	F86
0 002 345 701	RC 82 LS
0 002 345 702	RFC 82 LS
0 002 35 715	RFC 58 LZE 5
0 002 435 701	RC 42 S
0 002 620 708	RN 22 HJSE 6
0 002 630 701	RC 62 HJS 6
0 002 630 715	RC 42 HJS 3E5
0 002 635 100	RC 52 LJS 4E
0 002 635 600	J65
0 002 635 700	RC 52 LJS
0 002 635 701	RC 52 LJS 5
0 002 640 700	RC 72 LJS
0 002 640 900	RC 62 HJSP
0 002 640 904	RN 62 LJZDP 6
0 002 640 907	RN 62 LJZEDP 6
0 002 645 600	J87
10 FR-4 AU	RTC 72
10 FR-6 CPU03	RTC 62 LSDP
10 FR-6 CPU03	RTC 62 LSDP
12 F-6 LPPR2L	ZN 62 LSDPFRSO
12 FR-4 DPUT	RZC 82 LSDPT
12 FR-4 MPPUS	RZC 82 HSDPS
12 FR-5 DU	RZC 72 LS
12 FR-5 SDU	RZC 68 HS2
12 FR-6 DU	RZC 62 LS 5
12 FR-6 DUT	RZC 62 LS
12 FR-6 LUX	RZC 62 LSE
12 FR-7 DU	RZC 58 LS
12 FR-7 ME	RZC 58 HST
12 FR-7 SE	RZC 62 HSET
12 VR-6 MPPUS	RWC 62 HSDPS
12 VR-7 SPUX	RWC 58 HSE5DP
12 VR-8 SE	RWC 52 HSK
12 ZR-5 TPP2	RXN 72 HSDPFT
12 ZR-6 MIP2L	RXN 72 HSIPIFSO
12 ZR-6 SPO3	RXC 62 HSEDP
12 ZR-6 SPP2-1	RXN 62 HSDP
12 ZR-7 SPO3	RXC 58 HSEDP
12 ZR-8 STP	RXC 42 HSEDP 2A
12 ZR-8 TP	RXC 42 HZGP 5
12 FR-6DPUX	RZC 62 LSDP 5K
14 F-5 NPUR2T	ZN 68 HSTDPR
14 F-5 DPURS2	FN 68 LZDPR
14 F-5 DU	RFC 82 LS
14 F-5 MIUR2L	FN 72 HZIPRSO
14 F-5 MPUR2L	FN 72 HZIPRSO
14 F-6 DTU	FC 62 LS 3X
14 F-6 DTU	RFC 62 LS 3X
14 F-6 DUO	FC 62 LS
14 F-6 DUOR	FC 62 LS

**EYQUEM**

**EYQUEM****BERU**

14 F-6 HTPRX02	FN 62 LZFDPR 2A
14 F-6 LPURW03	FC 62 LSDPR
14 F-7 DU	FC 52 LS
14 F-7 DU0	FC 58 LS
14 F-7 DUOR	RFC 58 LS
14 F-7 HPURX2	RFN 52 LZDPF 5
14 F-7 HUR2	FN 58 LZKFR
14 F-7 HURU02	FN 58 LZKFR 5
14 F-7 LDUR4	RFC 58 LZ 2E
14 F-7DPUR02	FN 58 LZDPR
14 F-8 DPURX02	FN 42 LZDPR 5
14 F-8 DU	FC 42 LS
14 F-8 DU0	FC 42 LS
14 F-8 DUR	FC 52 LZR
14 F-8 DU4	FC 42 LS
14 F-8 LUR	RFC 52 LZE
14 FGH-6 DTUR	RFC 62 LZ 3EX
14 FGH-7 DTURX	RFC 58 LZ 3EX
14 FGR-6 DDU	RFC 62 LZ 2
14 FGR-6 HQU	RFC 62 LS4GF 6
14 FGR-7 CTU	RFC 58 LS 3
14 FGR-7 KQE	RFC 52 LZ 4E
14 FGR-7 KQU	RFC 52 LZ 4E
14 FGR-8 CTU	RFC 52 LS 3
14 FGR-8 KQU	RFC 42 LZ 4E
14 FLR-8 LDUX	RFC 42 LZ 2E
14 FR-5 DU	RFC 82 LS
14 FR-6 DPOX	RFC 62 LSDP 5
14 FR-6 DPURX02	RFN 62 LZDP 5
14 FR-6 DU	RFC 62 LS
14 FR-6 DUX	RFC 62 LS 5
14 FR-6 MPU2	RFN 62 HZDP
14 FR-7 DPPUW2	RFN 58 LZDP
14 FR-7 DPURX02	RFN 58 LZDP 5
14 FR-7 DQUP7	RFC 58 LZP 4
14 FR-7 DU	RFC 52 LS
14 FR-7 DU2	RFN 58 LZ
14 FR-7 DU2	RFN 58 LZ 3A
14 FR-7 DUW	RFC 58 LZK
14 FR-7 DUX	RFC 52 LS 5
14 FR-7 DUX	RFC 58 LS 5
14 FR-7 HUX	RFC 58 LZ 5
14 FR-7 KDU	RFC 58 LZ 2
14 FR-7 KPU	RFC 52 LZDP
14 FR-7 KPUV	RFC 52 LZDP 6
14 FR-7 KPUX	RFC 52 LZDP 5
14 FR-7 KU	RFC 58 LZ
14 FR-7 KUOX	RFC 58 LZ 5
14 FR-7 LDU	RFC 58 LZ 2E
14 FR-7 LDUW	RFC 58 LZ 2E
14 FR-7 LUX	RFC 58 LZ 5
14 FR-7 MU2	RFN 58 HZ
14 FR-7 MU2	RFN 58 HZ 3A
14 FR-7 MUX2	RFN 52 HZ5
14 FR-7 NUX2	RFN 58 HZ 5
14 FR-7 SPUX03	RFC 58 HZEDP 5
14 FR-7 DPU3	RFC 58 LZDP
14 FR-7 DPU3	RFC 58 LZP
14 FR-7LPURX02	RFN 58 LZDPE5
14 FR-8 DPU2	RFN 42 LZP
14 FR-8 DU	RFC 42 LS
14 FR-8 DUX	RFC 42 LS 5
14 FR-8 HUT	RFN 42 LZG 5
14 FR-8 KUOU	RFC 58 LZ 5
14 FR-8 LDU3	RFC 42 LZ 2E

**EYQUEM****BERU**

14 FR-8 LDUOX4	RFC 42 LZ 2E
14 FR-8 LPU02	RFC 42 LZDP
14 FR-8 LU2	RFN 42 LZG
14 FR-8 MPURX02	RFN 42 HZDP 5
14 FR-8 MPUX2	RFN 42 HZP 5
14 FR-8 MU2	RFN 52 HZ
14 FR-8 NQU23	RFN 52 HZ 3A
14 GH-7 DTUR	RC 58 LZ 3EX
14 GH-8 DTUR	RC 52 LZ 3EX
14 GH-8 DTURX	RC 52 LZ 3EX
14 K-5 DU	C 82 LJS
14 K-5 DU0	C 82 LJS
14 K-6 DU	C 72 LJS
14 K-6 DU0	C 72 LJS
14 K-7 DU	C 62 LJS
14 K-7 DU0	C 62 LJS
14 K-7DU	C 52 LJS
14 K-7DU0	C 52 LJS
14 K-8 DU	C 42 LJS 3
14 KGR -7 KQU	RC 52 LJS 4E
14 KR 6 MPX	RC 62 HJSP
14 KR-10 SUV2	RN 22 HJSE 6
14 KR-6 DPUV02	RN 62 LJZDP 6
14 KR-6 DU	RC 72 LJS
14 KR-6 KPUV02	RN 62 LJZEDP 6
14 KR-7 DU	RC 52 LJS
14 KR-7 DUX	RC 52 LJS 5
14 KR-8 MUV	RC 62 HJS 6
14 KR-8 STUX	RC 42 HJS 3E5
14 R-5 DU	RC 82 LS
14 R-6 DU	RC 72 LS
14 R-6 DUX	RC 72 LS 5
14 R-7 BU	RC 42 S
14 R-7 DU	RC 62 LS
14 R-7 DUX	RC 62 LS 5
14 R-8 DU	RC 52 LS
14 R-8 DU4	RC 52 LS
14 R-8 DUX	RC 52 LS 5
14 R-9 DU	RC 32 LS
14 R-9 EU0	R 500 CT
14 S-9E0	R 502 CT
14 SR-9E0	R 502 CT
14 SR-5F	R 755 CT
14 SR-6 F	R 700 CTS
14 Z-3 AU	C 82
14 Z-3 AU	RC 82
14 Z-3 CU	C 82 L
14 Z-4 AU	C 72
14-10A	200
14-4 DPO	805 LP
14-5 AU	C 62
14-5 DTU	C 82 LS 3X
14-5 DU	C 82 LS
14-5 DU0	C 82 LS
14-6 BU	C 62 S
14-6 DTU	C 72 LS 3X
14-6 DU	C 72 LS
14-6 DU0	C 72 LS
14-7 AU	C 42
14-7 BU	C 42 S
14-7 DTU	C 62 LS 3X
14-7 DU	C 62 LS
14-7 DU0	C 62 LS
14-7 E	500 C
14-8 AU	C 32

**EYQUEM****BERU**

14-8 BU	C 32 S
14-8 DTU	C 52 LS 3X
14-8 DU	C 52 LS
14-8 DU0	C 52 LS
14-8 E	500 C
14-8 LUR	RC 52 LZE
14-9 DU	C 32 LS
14-9 DU0	C 32 LS
14-9 EU0	R 500 CT
14-10 A	200
18 K-6 BU	RKC 62 JS
18 K-7 BU	RKC 62 JS
UX 56	L87
UX 79	L65
UXF 56	F86
UXF 79	F54
UXK 79	J65
Z 1	C 52 LS
Z 10	C 42 S
Z 100	FC 42 LS
Z 103	805 LP
Z 106	R 700 CTS
Z 11	C 62 LS
Z 118	C 32 S
Z 119	RC 52 LS
Z 12	C 62 LS 3X
Z 123	RFC 58 LZ 2
Z 127	RC 52 LJS 4E
Z 13	RFC 58 LS
Z 14	RFC 58 LZ 2E
Z 145	RFC 62 LZ 2
Z 149	RFC 52 LZDP 5
Z 15	RFC 52 LS
Z 150	RFC 52 LZDP 6
Z 151	RFC 52 LZDP
Z 155	RFC 58 LZ
Z 157	RFC 58 LZ 5
Z 158	RFC 58 LZ 5
Z 16	RFC 52 LS 5
Z 16	RFC 58 LZ 5
Z 17	C 52 LJS
Z 17	C 62 LJS
Z 172	RFC 52 LZ 4E
Z 173	RFC 42 LZ 4E
Z 176	RFN 52 LZDPF 5
Z 177	RC 62 HJS 6
Z 18	C 52 LJS
Z 18	C 62 LJS
Z 183	RFN 52 HZ
Z 184	RFN 58 HZ
Z 184	RFN 58 HZ 3A
Z 188	FN 58 LZDPR
Z 19	RC 42 S
Z 193	RFN 58 LZ
Z 193	RFN 58 LZ 3A
Z 199	RTC 72
Z 2	C 52 LS 3X
Z 20	RC 62 LS
Z 200	FN 58 LZKFR
Z 203	RFN 42 LZG
Z 204	RFC 52 LS 3
Z 208	RFC 42 LZ 2E
Z 209	RN 62 LJZDP 6
Z 21	RC 62 LS 5
Z 210	RTC 62 LSDP

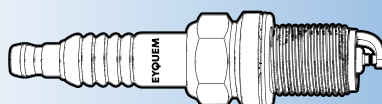

**EYQUEM****BERU**

Z 216	RN 22 HJSE 6
Z 219	RFN 42 HZDP 5
Z 22	C 72 LS
Z 221	RFN 62 LZDP 5
Z 222	RC 42 HJS 3E5
Z 223	RFN 52 HZ 3A
Z 224	RFC 58 LZDP
Z 224	RFC 58 LZP
Z 225	RFC 58 LZ 5
Z 226	RFN 62 HZDP
Z 227	FC 52 LZWR
Z 228	RFN 58 LZDP 5
Z 23	FC 62 LS
Z 230	RN 62 LJZEDP 6
Z 233	RXC 62 HSEDP
Z 234	RZC 58 LS
Z 235	RFC 58 HZEDP 5
Z 236	FN 62 LZFDPR 2A
Z 237	RFC 58 LZP 4
Z 238	RFN 42 LZP
Z 239	RFC 52 LZ 4E
Z 24	RFC 62 LS
Z 240	FN 42 LZDPR 5
Z 242	RXC 42 HZGP 5
Z 243	RWC 52 HSK
Z 247	RFC 58 LZK
Z 248	RFN 42 LZG 5
Z 249	RFC 58 LZ 5
Z 25	C 72 LJS
Z 257	RFC 58 LZ 2E
Z 26	RC 72 LJS
Z 27	RC 72 LS
Z 260	R 755 CT
Z 262	R 502 CT
Z 269	R 502 CT
Z 272	FN 58 LZKFR 5
Z 273	RFN 58 HZ 5
Z 274	RWC 62 HSDPS
Z 278	RFC 42 LZDP
Z 28	RC 72 LS 5
Z 284	RFC 62 LSDP 5
Z 286	RZC 68 HS2
Z 288	RXC 58 HSEDP
Z 29	RFC 82 LS
Z 291	RZC 72 LS
Z 292	RZC 62 LS 5
Z 293	RZC 62 LSE
Z 3	RC 52 LZE
Z 30	RFC 82 LS
Z 300	RFC 62 LS4GF 6
Z 301	RFN 58 LZDPE5
Z 302	RFN 42 HZP 5
Z 303	RFN 52 HZ5
Z 31	C 82 LJS
Z 32	RKC 62 JS
Z 320	RXC 42 HSEDP 2A
Z 325	RWC 58 HSE5DP
Z 33	RKC 62 JS
Z 332	RXN 62 HSDP
Z 333	RZC 62 LSDP 5K
Z 336	RXN 62 HSEP
Z 337	RFN 58 LZDP
Z 338	RZC 82 LSDPT
Z 347	FN 68 LZDPR
Z 348	FN 72 HZIPRSO

**EYQUEM****BERU**

Z 349	FC 62 LSDPR
Z 357	RZC 82 HSDPS
Z 358	RZC 62 LS
Z 359	ZN 68 HSTDPR
Z 361	RZC 58 HST
Z 362	RZC 62 HSET
Z 364	RXN 72 HSDPFT
Z 365	ZN 62 LSDPFRSO
Z 366	RXN 72 HSIPFSO
Z 367	FN 72 HZIPRSO
Z 37	C 82
Z 37	RC 82
Z 38	C 82 L
Z 39	C 72
Z 4	RFC 52 LZE
Z 40	C 62
Z 42	C 82 LS
Z 43	C 82 LS
Z 44	C 82 LS 3X
Z 46	C 82 LJS
Z 47	RC 82 LS
Z 48	C 62 S
Z 5	FC 42 LS
Z 50	C 72 LS
Z 51	C 72 LS 3X
Z 52	RFC 62 LS 3X
Z 53	FC 62 LS 3X
Z 54	FC 62 LS
Z 55	C 72 LJS
Z 57	C 42
Z 6	C 42 LJS 3
Z 60	RFC 58 LS 3
Z 61	C 62 LS
Z 63	FC 52 LS
Z 64	FC 58 LS
Z 67	RC 52 LJS 5
Z 68	C 32
Z 69	C 52 LS
Z 71	FC 42 LS
Z 72	RFC 42 LS
Z 73	RFC 42 LS 5
Z 74	RFC 42 LZ 2E
Z 76	C 32 LS
Z 77	C 32 LS
Z 8	RC 52 LS
Z 82	RC 32 LS
Z 83	R 700 CTS
Z 84	R 502 CT
Z 85	200
Z 89	RFC 62 LZ 3EX
Z 9	RC 52 LS 5
Z 90	RFC 58 LZ 3EX
Z 91	RC 58 LZ 3EX
Z 92	RC 52 LZ 3EX
Z 93	RC 52 LZ 3EX
Z 95	RC 52 LJS
Z 97	RC 62 HJSP
Z 98	RFC 58 LZ 2E
Z 99	RFC 62 LS 5

BMW

2158165	RXN 62 HSEP
2158165	RXC 58 HSEDP
0 030 548	RFC 58 LZP 4
7 528 400	RFN 58 LZDPE5

**EYQUEM****BMW**

12 12 0 032 135	RFN 58 LZDPE5
12 12 0 032 137	RFC 58 HZEDP 5
12 12 0 032 138	RFC 58 HZEDP 5
12 12 0 034 098	RXC 58 HSEDP
12 12 0 034 098	RXN 62 HSDP
12 12 0 034 677	RXC 62 HSEDP
12 12 0 035 915	RFC 58 HZEDP 5
12 12 0 035 933	RXC 62 HSEDP
12 12 0 037 607	RFC 58 LZP 4
12 12 0 037 608	RFC 58 LZP 4
12 12 0 038 894	RXN 72 HSDPFT
12 12 0 038 896	RXN 72 HSDPFT
12 12 0 039 664	RXN 72 HSDPFT
12 12 0 040 551	RXN 72 HSIPFSO
12 12 0 040 581	RXN 72 HSDPFT
12 12 0 041 666	RXN 72 HSIPFSO
12 12 0 141 871	RFC 58 LZP 4
12 12 1 435 955	RFC 58 LZP 4
12 12 1 435 956	RFC 58 LZP 4
12 12 2 158 165	RXC 58 HSEDP
12 12 2 158 165	RXN 62 HSEP
12 12 2 158 252	RFN 58 LZDPE5
12 12 2 158 253	RFC 58 HZEDP 5
12 12 2 163 332	RXC 58 HSEDP
12 12 2 293 697	RXN 62 HSDP
12 12 9 059 162	RFC 58 LZ 2E
12 12 9 059 794	RFC 58 LZ 2E
12 12 9 061 811	RFC 58 LZ 2E
12 12 9 063 428	RFC 58 LZ 2E
12 12 9 064 619	RFC 58 LZ 2E
12 12 9 071 003	RFC 58 LZP 4

BOSCH

+41 Super Plus	RZC 58 LS
+45 Super Plus	FN 42 LZDPR 5
+48 Super Plus	RFC 58 LZP 4
+51 Super Plus	RFC 58 LZ 5
0 241 145 515	ZN 62 LSDPFRSO
0 241 219 001	200
0 241 219 540	200
0 241 219 543	200
0 241 219 891	200
0 241 225 013	C 32 LS
0 241 225 544	200
0 241 225 545	C 32 LS
0 241 225 549	200
0 241 225 550	C 32 LS
0 241 225 556	C 32 LS
0 241 225 585	C 30 LS
0 241 225 593	C 32 LS
0 241 229 060	C 52 LS 3X
0 241 229 061	C 52 LS
0 241 229 062	C 52 LS
0 241 229 565	502
0 241 229 574	600 LS
0 241 229 574	C 52 LS
0 241 229 578	C 32 S
0 241 229 580	500 C
0 241 229 588	600 LS
0 241 229 588	C 52 LS
0 241 229 596	600 LS
0 241 229 604	502
0 241 229 604	C 32
0 241 229 612	502
0 241 229 612	C 32

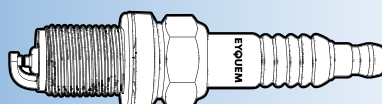

**EYQUEM****BOSCH**

0 241 229 619	C 52 LS 3X
0 241 229 634	FC 42 LS
0 241 229 641	C 32 S
0 241 229 676	RFC 52 LZE
0 241 229 685	FC 42 LS
0 241 229 712	FC 42 LS
0 241 229 713	FC 42 LS
0 241 229 714	C 32 S
0 241 229 715	C 52 LS
0 241 229 716	C 52 LS 3X
0 241 229 857	502
0 241 229 887	502
0 241 229 918	502
0 241 229 923	502
0 241 229 953	RC 52 LZE
0 241 229 956	RC 52 LZ 3EX
0 241 229 960	FC 42 LS
0 241 229 961	FC 42 LS
0 241 230 001	502
0 241 230 500	502
0 241 235 103	C 62 LS
0 241 235 536	600 S
0 241 235 563	707 LS
0 241 235 563	750 LS
0 241 235 563	C 62 LS
0 241 235 564	600 S
0 241 235 564	C 42 S
0 241 235 585	C 42 S
0 241 235 585	600 S
0 241 235 602	707 LS
0 241 235 602	750 LS
0 241 235 602	C 62 LS
0 241 235 607	C 42
0 241 235 610	707 LS
0 241 235 610	750 LS
0 241 235 619	C 42
0 241 235 633	C 62 LS 3X
0 241 235 635	C 62 LJS
0 241 235 636	C 62 LJS
0 241 235 643	C 62 LS 3X
0 241 235 663	RC 58 JS
0 241 235 666	707 LS
0 241 235 666	750 LS
0 241 235 668	C 62 LJS
0 241 235 674	RFC 58 LZ 2E
0 241 235 676	FC 58 LS
0 241 235 676	RFC 58 LS
0 241 235 681	C 62 LJS
0 241 235 690	RFC 58 LZ 2E
0 241 235 693	C 62 LS
0 241 235 697	RFC 58 LZ 3EX
0 241 235 704	RFC 58 LS
0 241 235 705	C 62 LS
0 241 235 720	FN 58 LZDPR
0 241 235 735	FN 58 LZKFR
0 241 235 750	FC 52 LS
0 241 235 753	C 52 LJS
0 241 235 753	C 62 LJS
0 241 235 754	C 42 S
0 241 235 755	C 62 LS
0 241 235 756	C 62 LS 3X
0 241 235 757	RC 58 LZ 3EX
0 241 235 804	600 S
0 241 235 818	RC 58 LZ 3EX
0 241 235 915	C 52 LJS

**EYQUEM****BOSCH**

0 241 236 800	C 52 LJS
0 241 240 002	755 LS
0 241 240 524	755 LJS
0 241 240 530	755 LS
0 241 240 532	C 62 S
0 241 240 539	755 LS
0 241 240 542	FC 62 LS
0 241 240 547	755 LJS
0 241 240 563	755 LJS
0 241 240 564	FC 62 LS 3X
0 241 240 569	RFC 62 LS 5
0 241 240 579	FC 62 LS
0 241 240 587	FC 62 LS
0 241 240 590	FC 62 LS 3X
0 241 240 592	RFC 62 LZ 3EX
0 241 240 610	C 72 LJS
0 241 240 611	C 72 LS
0 241 240 844	C 72 LS
0 241 240 848	C 72 LJS
0 241 242 502	J87
0 241 245 070	C 82 LS 3X
0 241 245 531	1000
0 241 245 531	850
0 241 245 555	R 700 CTS
0 241 245 580	C 62
0 241 245 581	C 72 L
0 241 245 602	C 62
0 241 245 603	C 72 L
0 241 245 673	FN 72 HZIPRSO
0 241 245 872	C 82 LS
0 241 248 531	1000
0 241 248 531	850
0 241 248 531	C 72
0 241 248 538	C 82 L
0 241 248 540	1000
0 241 248 540	850
0 241 248 540	C 72
0 241 250 502	805 LP
0 241 250 512	805 LP
0 241 255 505	805 LJSP
0 241 256 512	C 82
0 241 256 512	RC 82
0 241 256 519	C 82
0 241 256 519	RC 82
0 241 299 954	RFC 52 LZE
0 242 040 502	RTC 62 LSDP
0 242 040 502	RTC 62 LSDP
0 242 055 501	RTC 72
0 242 129 500	RXC 42 HZGP 5
0 242 129 503	RWC 52 HSK
0 242 129 508	RWC 52 HSK
0 242 129 510	RWC 52 HSK
0 242 129 512	RXC 58 HSEDP
0 242 129 521	RZC 58 HST
0 242 129 529	RWN 42 HSIPW
0 242 129 801	RWC 52 HSK
0 242 135 509	ZN 68 HSTDPR
0 242 135 515	RZC 58 LS
0 242 135 515	RZC 62 LSE
0 242 135 515	RZC 62 LS
0 242 135 515	RZC 62 LS 5
0 242 135 515	RZC 72 LS
0 242 135 517	RWN 42 HSIPS
0 242 135 518	RXC 42 HSEDP 2A
0 242 135 518	RXN 62 HSDP

**EYQUEM****BOSCH**

0 242 135 524	RWC 58 HSE5DP
0 242 135 528	RZC 62 HSET
0 242 135 545	RZC 58 HST
0 242 135 802	RZC 58 LS
0 242 140 512	ZN 68 HSTDPR
0 242 140 519	RZC 58 LS
0 242 140 543	RXN 72 HSIPFS
0 242 145 535	RXN 72 HSIPFS
0 242 145 537	RXN 62 HSDP
0 242 145 541	RXN 72 HSDPFT
0 242 145 550	RZC 68 HS2
0 242 222 501	L3
0 242 225 524	RC 32 LS
0 242 225 548	RC 32 LS 5
0 242 225 550	RC 32 LS
0 242 225 572	RC 22 LJZ 7
0 242 225 580	RFC 32 LZ 5
0 242 229 528	RC 42 JS
0 242 229 530	RFC 42 LS 5
0 242 229 531	RC 52 LS
0 242 229 538	RC 52 LS
0 242 229 566	RC 52 LS 5
0 242 229 568	RFC 42 LS
0 242 229 570	RC 52 LS
0 242 229 587	RFC 42 LS
0 242 229 590	RFN 42 LZG 5
0 242 229 594	RFC 42 LS
0 242 229 607	RC 52 LS
0 242 229 613	RFC 42 LZ 4E
0 242 229 626	RFC 42 LZ 2E
0 242 229 628	RFC 58 LZ 2
0 242 229 630	RFN 42 HZP 5
0 242 229 630	RFN 52 HZ
0 242 229 632	RC 52 LS
0 242 229 650	RC 62 HJS 6
0 242 229 654	RFC 42 LZ 2E
0 242 229 656	600 LS
0 242 229 658	RC 52 LZ 3EX
0 242 229 659	RFC 42 LS
0 242 229 660	RFC 42 LS 5
0 242 229 661	RC 42 HJS 3E5
0 242 229 673	RFN 52 LZ
0 242 229 699	RFN 42 LZG
0 242 229 708	RFN 42 HZDP 5
0 242 229 713	FN 42 LZDPR 5
0 242 229 724	FC 52 LZWR
0 242 229 877	RC 62 HJS 6
0 242 229 925	FN 42 LZDPR 5
0 242 230 500	FN 42 LZDPR 5
0 242 230 500	FN 42 LZDPR 5
0 242 232 501	F54
0 242 232 502	F54-5
0 242 232 504	L65
0 242 232 505	L65
0 242 232 506	N43
0 242 232 507	J65
0 242 235 522	RC 42 S
0 242 235 538	RC 52 LJS
0 242 235 542	RC 52 LJS
0 242 235 544	RFC 58 LS 5
0 242 235 551	RFC 52 LS
0 242 235 566	RC 52 LJS
0 242 235 567	RFC 58 LZE 5
0 242 235 579	RFC 52 LS
0 242 235 587	RFN 58 LZ

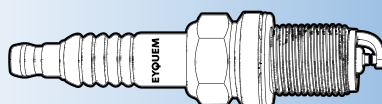

**EYQUEM****BOSCH**

0 242 235 587	RFN 58 LZ 3A
0 242 235 588	RFC 58 LZ 5
0 242 235 589	RFC 58 LZ 2E
0 242 235 592	RC 52 LJS 5
0 242 235 597	RFC 58 LS
0 242 235 599	RFC 58 LZ
0 242 235 602	RFC 58 LZ 5
0 242 235 605	RFC 58 LZ 2E
0 242 235 607	RC 52 LJS 4E
0 242 235 609	RFC 58 LZ 2
0 242 235 610	RFC 58 LZ
0 242 235 612	RFC 58 LS 5
0 242 235 615	RFC 58 LS 3
0 242 235 617	RFC 58 LZF 4
0 242 235 623	RFC 58 LZ 3EX
0 242 235 624	RFN 58 LZ
0 242 235 624	RFN 58 LZ 3A
0 242 235 625	RFC 58 LZ 2E
0 242 235 636	RFN 58 HZ
0 242 235 636	RFN 58 HZ 3A
0 242 235 640	RFN 58 LZ
0 242 235 640	RFN 58 LZ 3A
0 242 235 644	RFC 58 LZK
0 242 235 663	707 LS
0 242 235 663	750 LS
0 242 235 663	RC 62 LS
0 242 235 664	RC 58 LZ 3EX
0 242 235 665	600 S
0 242 235 666	RFC 52 LS
0 242 235 667	RFC 52 LS 5
0 242 235 692	RFC 58 LZF 5
0 242 235 707	RC 62 LS 5
0 242 235 715	RFC 52 LZ 4E
0 242 235 746	RC 62 HJSP
0 242 235 748	RFC 58 LS 3
0 242 235 756	RFC 58 HZEDP 5
0 242 235 758	RFC 58 HZEDP 5
0 242 235 764	RFN 52 LZDPF 5
0 242 235 776	RFN 58 LZDPE5
0 242 235 791	RFN 52 HZ 3A
0 242 235 811	RC 62 LS
0 242 235 848	RC 62 LS 5
0 242 235 849	RFC 52 LS 5
0 242 235 981	RFC 58 LZF 4
0 242 235 983	RFC 58 LZF 5
0 242 236 510	RFC 58 HZEDP 5
0 242 236 541	RFC 58 LZ 5
0 242 236 544	FN 42 LZDPR 5
0 242 236 562	RFC 58 LZF 4
0 242 236 563	RN 62 LJZDP 6
0 242 236 565	FN 58 LZKFR 5
0 242 236 585	RFC 58 LZF 5
0 242 240 511	RC 72 LS
0 242 240 526	RFC 62 LS
0 242 240 528	RFC 62 LS 3X
0 242 240 530	RFC 52 LZDP
0 242 240 531	RC 72 LS 5
0 242 240 533	RFC 52 LZDP 5
0 242 240 539	RFC 62 LS 5
0 242 240 547	RFC 62 LS 3X
0 242 240 554	RFN 62 LZ
0 242 240 561	RC 62 S
0 242 240 577	RFN 62 LZ
0 242 240 590	RFC 62 LS4GF 6
0 242 240 591	RC 72 LJS

**EYQUEM****BOSCH**

0 242 240 592	RC 72 LS
0 242 240 593	RFC 62 LS
0 242 240 606	RFC 52 LZDP
0 242 240 619	RFN 62 HZDP
0 242 240 620	RN 62 LJZEDP 6
0 242 240 621	RFN 62 LZDP 5
0 242 240 625	RFN 62 LZDP 5
0 242 240 649	RFC 62 LSDP 5
0 242 240 665	FN 72 LZIPFRS
0 242 240 807	RC 72 LJS
0 242 240 847	RC 62 S
0 242 240 579	RC 72 LS
0 242 242 502	F86
0 242 242 505	L87
0 242 245 515	RFC 82 LS
0 242 245 521	RC 72 L
0 242 245 536	RFC 82 LS
0 242 245 537	RC 82 LS
0 242 245 550	RFC 82 LS 5
0 242 245 552	RC 82 LS
0 242 245 576	FN 68 LZDPR
0 242 250 503	RC 82 L
0 242 250 506	850
0 242 250 506	RC 72
0 242 250 516	1000
0 242 250 803	RC 72
0 242 335 504	RKC 62 JS
0 242 340 501	RKC 62 JS
DR 6 BC	RKC 62 JS
DR 7 BC	RKC 62 JS
F 6 DC	FC 62 LS
F 6 DCOR	FC 62 LS
F 6 DCOR	RFC 62 LS
F 6 DCX	RFC 62 LS 5
F 6 DTC	FC 62 LS 3X
F 6 LTRC	RFC 62 LZ 3EX
F 7 DC	FC 52 LS
F 7 DCO	RFC 58 LS
F 7 DCR4	RFC 58 LS
F 7 DPP222T	FN 58 LZDPR
F 7 DUO	FC 58 LS
F 7 HER2	FN 58 LZKFR
F 7 LCR	RFC 58 LZ 2E
F 7 LDCR	RFC 58 LZ 2E
F 7 LTRC	RFC 58 LZ 3EX
F 8 DC	FC 42 LS
F 8 DCO	FC 42 LS
F 8 DC4	FC 42 LS
F 8 DPP33	FN 42 LZDPR 5
F 8 LCR	RFC 52 LZ 5
FGR 6 HQE 0	RFC 62 LS4GF 6
FGR 7 DQ+	RFC 58 LS 3
FGR 7 DQC	RFC 58 LS 3
FGR 7 DQE	RFC 58 LS 3
FGR 7 DQP	RFC 58 LZP 4
FGR 7 DQP+	RFC 58 LZP 4
FGR7 KQE 0	RFC 52 LZ 4E
FGR 8 KQE	RFC 42 LZ 4E
FLR 8 LD+U	RFC 42 LZ 2E
FLR 8 LDCU	RFC 42 LZ 2E
FQ 5 NPP 332 S	FN 72 HZIPRSO
FQR 7 ME	RFN 52 HZ 3A
FQR 8 DE	FC 52 LZWR
FQR 8 LEU2	RFN 42 LZG
FR 5 DC	RFC 82 LS

**EYQUEM****BOSCH**

FR 5 DCX	RFC 82 LS 5
FR 5 KPP 332 S	FN 68 LZDPR
FR 56	F86
FR 6 D+	RFC 62 LS
FR 6 DC	RFC 62 LS
FR 6 DC2	RFN 62 LZ
FR 6 DCX	RFC 62 LS 5
FR 6 DP1	RFC 52 LZDP
FR 6 DPP22	RFN 62 LZDP 5
FR 6 DPP22U	RFN 62 LZDP 5
FR 6 DPX	RFC 52 LZDP 5
FR 6 DTC	RFC 62 LS 3X
FR 6 DTCW	RFC 62 LS 3X
FR 6 HI 332	FN 72 LZIPFRS
FR 6 KPP 33 X+	RFC 62 LSDP 5
FR 6 MPP 332	RFN 62 HZDP
FR 7 D+	RFC 52 LS
FR 7 DC	RFC 52 LS
FR 7 DCO	RFC 58 LS
FR 7 DC2	RFN 58 LZ
FR 7 DC2	RFN 58 LZ 3A
FR 7 DC9	RFC 58 LZK
FR 7 DCU	RFC 58 LS 5
FR 7 DCX	RFC 52 LS 5
FR 7 DCX	RFC 58 LS 5
FR 7 DCX+	RFC 52 LS 5
FR 7 DE	RFN 58 LZ
FR 7 DE	RFN 58 LZ 3A
FR 7 DPP22U	RFN 58 LZDP 5
FR 7 HC+	RFC 58 LZ 5
FR 7 HC+	FN 58 LZKFR 5
FR 7 HCOX	RFC 58 LZ 5
FR 7 HPP 222	RFN 52 LZDPF 5
FR 7 KC	RFC 58 LZ
FR 7 KCW	RFC 58 LZ
FR 7 KCX	RFC 58 LZ 5
FR 7 KDC	RFC 58 LZ 2
FR 7 KPP33U+	RFN 58 LZDP 5
FR 7 KPP 332	RFN 58 LZDPE5
FR 7 LC2	RFC 58 LZ 5
FR 7 LCX	RFC 58 LZ 5
FR 7 LDC	RFC 58 LZ 2E
FR 7 LDC4	RFC 58 LZ 2E
FR 7 LTC	RFC 58 LZ 3EX
FR 7 ME	RFN 58 HZ
FR 7 ME	RFN 58 HZ 3A
FR 7 NPP33	RFC 58 HZEDP 5
FR 7 NPP332	RFC 58 HZEDP 5
FR 7 SE	RFC 58 HZEDP 5
FR 78	F54
FR 78X	F54-5
FR 8 D+	RFC 42 LS
FR 8 D+X	RFC 42 LS 5
FR 8 DC	RFC 42 LS
FR 8 DCO	RFC 42 LS
FR 8 DCX	RFC 42 LS 5
FR 8 DE	RFN 52 LZ
FR 8 DPP33	FN 42 LZDPR 5
FR 8 DPP33x	FN 42 LZDPR 5
FR 8 HC	RFN 42 LZG 5
FR 8 KDC	RFC 58 LZ 2
FR 8 ME	RFN 52 HZ
FR 8 ME	RFN 42 HZP 5
FR 8 SPP 332	RFN 42 HZDP 5
FR 9 LCX	RFC 32 LZ 5

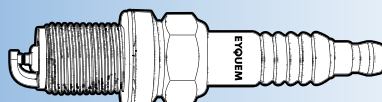

**EYQUEM**

BOSCH	
H 3 CS	805 LJSP
H 56	J87
H 6 DC	C 72 LJS
H 7 BC	RC 58 JS
H 7 DC	C 52 LJS
H 7 DC	C 62 LJS
H 7 DCO	C 62 LJS
H 7 DCO	C 52 LJS
HGR 7 KQC	RC 52 LJS 4E
HLR 8 STEK	RC 42 HJS 3E5
HR 6 DC	RC 72 LJS
HR 6 DPP 33 V	RN 62 LJZEDP 6
HR 7 DC	RC 52 LJS
HR 7 DCO	RC 52 LJS
HR 7 DCX	RC 52 LJS 5
HR 7 KPP 33+	RN 62 LJZDP 6
HR 7 MPP	RC 62 HJSP
HR 78	J65
HR 8 BC	RC 42 JS
HR 8 MEV	RC 62 HJS 6
HR 9 BC	RC 42 JS 5
HR 9 DCY	RC 22 LJZ 7
HS 5 E	R 755 CJT
HS 8 E	R 500 CJT
UR 3 AC	RTC 72
UR 3 AS	RTC 72
UR 6 DE	RTC 62 LSDP
UR 6 DE	RTC 62 LSDP
VR 7 SI 332 S	RWN 42 HSIPS
VR 7 SPP 33	RWC 58 HSE5DP
VR 8 SC+	RWC 52 HSK
VR 8 SE	RWC 52 HSK
VR 8 SEW	RWC 52 HSK
VR 8 SII 33 X	RWN 42 HSIPIW
W 10 A	200
W 10 AC	200
W 125 T1	200
W 125 T4	200
W 145 M1	502
W 145 T1	502
W 145 T3	500 C
W 150 M 11 S	502
W 200 T 35	705 S
W 3 AC	C 82
W 3 AC	RC 82
W 4 AC	C 72
W 4 CC	C 82 L
W 4 DP	805 LP
W 5 AC	C 62
W 5 BC	C 62 S
W 5 CC	C 72 L
W 5 DTC	C 82 LS 3X
W 5 DC	C 82 LS
W 5 DCO	C 82 LS
W 6 BC	C 62 S
W 6 DC	C 72 LS
W 6 DTC	C 72 LS 3X
W 7 AC	C 42
W 7 BC	C 42 S
W 7 DC	C 62 LS
W 7 DCO	C 62 LS
W 7 DTC	C 62 LS 3X
W 7 LTCR	RC 58 LZ 3EX
W 8 AC	502
W 8 AC	C 32

**EYQUEM**

BOSCH	
W 8 BC	C 32 S
W 8 DC	C 52 LS
W 8 DCO	C 52 LS
W 8 DTC	C 52 LS 3X
W 8 E	500 C
W 8 EC	500 C
W 8 LCR	RC 52 LZE
W 8 LTCR	RC 52 LZ 3EX
W 9 DC	C 32 LS
W 9 DCO	C 32 LS
W 9 LC	C 30 LS
W240P11S	850
W240T1	850
W250T1	850
W260T1	850
W95T1	200
W9A	200
W9AC	200
W9ACO	200
WR 11 EO	R 202 CT
WR 4 AC	850
WR 4 AC	RC 72
WR 4 AP	850
WR 4 CC	RC 82 L
WR 5 CC	RC 72 L
WR 5 D+	RC 82 LS
WR 5 DC	RC 82 LS
WR 56	L87
WR 6 BC	RC 62 S
WR 6 D+	RC 72 LS
WR 6 DC	RC 72 LS
WR 6 DCX	RC 72 LS 5
WR 7 BC	RC 42 S
WR 7 DC	RC 62 LS
WR 7 DCX	RC 62 LS 5
WR 7 LTC	RC 58 LZ 3EX
WR 78	L65
WR 78 G	N43
WR 78 X	L65
WR 78 X	L65-5
WR 8 DC	RC 52 LS
WR 8 DC04	RC 52 LS
WR 8 DC4	RC 52 LS
WR 8 DCX	RC 52 LS 5
WR 8 E	500 C
WR 8 EC	500 C
WR 8 LTC	RC 52 LZ 3EX
WR 9 DC	RC 32 LS
WR 9 DCX	RC 32 LS 5
WR 91	L3
WS 5 E	R 755 CT
WS 5 F	R 700 CTS
WS 6 F	R 700 CTS
WS 7 E	R 500 CT
WS R 5 F	R 700 CTS
WS R 6 F	R 700 CTS
WS R7 F	R 700 CTS
WS R8 F	R 700 CTS
Y 5 KPP 332 S	ZN 62 LSDPFRSO
YR 5 NDE	RZC 68 HS2
YR 6 DES	RZC 58 LS
YR 6 NPP 332	ZN 68 HSTDPR
YR 7 DC+	RZC 58 LS
YR 7 DC+	RZC 62 LS 5
YR 7 DC+	RZC 62 LSE

**EYQUEM**

BOSCH	
YR 7 DC+	RZC 72 LS
YR 7 DC+	RZC 62 LS
YR 7 DE	RZC 58 LS
YR 7 ME	RZC 58 HST
YR 7 MPP 33	ZN 68 HSTDPR
YR 7 SES	RZC 62 HSET
YR 8 MEU	RZC 58 HST
ZQR 8 SI 302	RXC 58 HSEDP
ZR 5 SI 332	RXN 62 HSDP
ZR 5 SPP 3320	RXN 72 HSIPFS
ZR 5 TPP 330	RXN 72 HSDPFT
ZR 6 SPP 3320	RXN 72 HSIPFS
ZR 7 SI 332 S	RXN 62 HSDP
ZR 8 TPP 15	RXC 42 HZGP 5
BRISK	
JR19	R 202 CT
PR15	R 755 CT
PR17	R 500 CT
CHAMPION	
BN 2	883 LJP
BN 7 Y	C 72 LJS
BN 9 GY	805 LJSP
BN 9 Y	C 62 LJS
C 10 YC	FC 42 LS
C 10 YCC	FC 42 LS
C 11 YCC	FC 42 LS
C 279 YC	FC 62 LS
C 281 YC	FC 52 LS
C 6 BYC	FC 62 LS 3X
C 7 YC	FC 58 LS
C 7 YCC	FC 58 LS
C 7 YCX	FC 58 LS
C 9 YC	FC 52 LS
C 9 YCC	FC 52 LS
C 9 YCX	FC 52 LS
CJ 6	R 755 CT
CJ 7 Y	R 700 CTS
CJ 8	R 500 CT
DJ 6	R 755 CJT
DJ 6 J	R 755 CJT
DJ 8	R 500 CJT
DJ 8 J	R 500 CJT
J 17 LM	R 202 CT
J 19 LM	R 502 CT
J 8	500 C
J 8 C	500 C
J 8 J	500 C
KA 6ZPHPB-1	ZN 62 LSDPFRSO
KC 6 PYPB	FN 68 LZDPR
KC 8 ZMCC	FN 58 LZKFR
KC8 ZMCC	RFC 62 LS4GF 6
KC8 ZMCC	FN 58 LZKFR 5
KEC6PYPB-1	FN 72 HZIPRSO
KEC6WYPB-1	FN 72 HZIPRSO
KER4PYPB	ZN 68 HSTDPR
L 4 G	1000
L 4 G	850
L 4 J	1000
L 4 J	850
L 4 J	C 72
L 5	1000
L 5	850
L 5	C 72

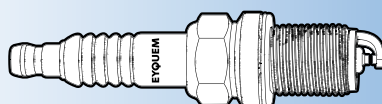

**EYQUEM****CHAMPION**

L 5	C 82
L 60 R	1000
L 60 R	850
L 62 R	1000
L 78	C 82
L 78 C	C 82
L 81	C 62
L 82	850
L 82	C 82
L 82 Y	C 62 S
L 82 YC	C 62 S
L 82 YCC	C 62 S
L 86 C	502
L 86 C	C 32
L 86 CC	502
L 86 CC	C 32
L 87 Y	600 S
L 87 Y	C 42 S
L 87 YC	600 S
L 87 YC	C 42 S
L 87 YCC	600 S
L 87 YCC	C 42 S
L 88	C 42
L 88 A	C 42
L 89 CM	C 32
L 92 Y	C 32 S
L 92 YC	C 32 S
L 95 YC	C 32 S
N 10 Y	707 LS
N 10 Y	750 LS
N 11 Y	600 LS
N 11 Y	C 32 LS
N 11 Y	C 52 LS
N 11 YC	600 LS
N 11 YC	C 32 LS
N 11 YC	C 52 LS
N 11 YCC	C 32 LS
N 12 YC	C 30 LS
N 12 YCC	C 30 LS
N 279 YC	755 LS
N 279 YC	C 82 LS
N 281 YC	C 52 LS
N 3	C 82 L
N 3 C	C 82 L
N 4 C	C 72 L
N 3 G	805 LP
N 6 BYC	C 82 LS 3X
N 6 Y	C 82 LS
N 6 YC	C 82 LS
N 6 YCC	C 82 LS
N 6 YCX	C 82 LS
N 7 BYC	C 72 LS 3X
N 7 BYC4	C 72 LS 3X
N 7 Y	755 LS
N 7 Y	C 72 LS
N 7 YC	755 LS
N 7 YC	C 72 LS
N 7 YCC	755 LS
N 7 YCC	C 72 LS
N 7 YCX	C 72 LS
N 79 Y	707 LS
N 79 Y	750 LS
N 79 YC	707 LS
N 79 YC	750 LS
N 8 Y	755 LS

**EYQUEM****CHAMPION**

N 8 Y	C 62 LS
N 8 YC	C 62 LS
N 89 Y	707 LS
N 9 BYC	C 52 LS 3X
N 9 BYC4	C 52 LS 3X
N 9 Y	707 LS
N 9 Y	C 62 LS
N 9 YC	707 LS
N 9 YC	C 62 LS
N 9 YCC	C 62 LS
N 9 YCX	C 62 LS
OE 001	C 62 LS
OE 002	RFN 52 LZ
OE 003	FC 52 LS
OE 004	RC 62 LS
OE 005	RFC 52 LS
OE 006	RC 62 LS
OE 007	600 S
OE 007	C 42 S
OE 008	RC 72 LS
OE 009	C 52 LJS
OE 010	755 LS
OE 010	C 72 LS
OE 011	RC 52 LJS
OE 012	C 72 LS 3X
OE 013	RFC 42 LS
OE 014	RFN 58 LZ
OE 014	RFN 58 LZ 3A
OE 015	C 30 LS
OE 016	RFC 42 LS
OE 017	FC 58 LS
OE 018	RC 72 LS
OE 019	RFC 42 LZ 2E
OE 020	RC 52 LJS
OE 021	RFC 62 LS 3
OE 023	FC 52 LS
OE 024	RFC 52 LS 5
OE 025	RC 58 LZ 3EX
OE 026	RFC 58 LZ 2E
OE 027	RC 52 LZ 3EX
OE 028	C 52 LS 3X
OE 029	RC 62 HJSP
OE 030	RFC 58 LZ 2
OE 031	RC 62 HJS 6
OE 032	RFC 62 LZ 3EX
OE 033	RFC 58 LZK
OE 034	RFN 58 LZ
OE 034	RFN 58 LZ 3A
OE 035	RFN 58 HZ
OE 035	RFN 58 HZ 3A
OE 036	C 52 LJS
OE 037	600 S
OE 037	C 32
OE 038	C 62 S
OE 039	RFC 52 LS 5
OE 042	RC 30 LS
OE 043	RFC 58 LS
OE 044	C 52 LS 3X
OE 045	RC 32 LS
OE 047	RC 62 LS 5
OE 048	RC 62 LS 5
OE 049	RC 32 LS 5
OE 050	755 LJS
OE 050	C 72 LJS
OE 051	RC 32 LS

**EYQUEM****CHAMPION**

OE 052	RZC 58 LS
OE 054	RKC 62 JS
OE 056	RFC 58 LS 5
OE 057	FC 42 LS
OE 058	FC 58 LS
OE 059	C 32 S
OE 062	RFC 42 LS 5
OE 063	RFC 42 LS 5
OE 064	RC 62 S
OE 065	600 LS
OE 065	C 32 LS
OE 066	RFC 52 LZE
OE 067	C 72 LJS
OE 068	707 LS
OE 068	C 82 L
OE 076	FC 62 LS 3X
OE 077	RFC 62 LS 3X
OE 078	805 LP
OE 080	RFC 58 LS 5
OE 081	RFC 62 LS 5
OE 084	C 82 LS
OE 085	RFC 52 LS 3
OE 087	C 82 LS
OE 088	RFC 42 LS
OE 089	RFC 58 LZ F 5
OE 090	C 82 LJS
OE 093	RFN 52 LZ
OE 094	RFC 82 LS
OE 097	RC 72 LS
OE 098	RC 72 L
OE 100	C 52 LS 3X
OE 101	RC 32 LS 5
OE 102	RFN 58 LZ
OE 102	RFN 58 LZ 3A
OE 108	RC 82 L
OE 109	C 82 LS 3X
OE 110	RFC 82 LS
OE 111	RC 52 LS
OE 113	RC 52 LS 5
OE 114	RFN 42 LZG 5
OE 116	RC 82 LS
OE 117	RC 72 LS 5
OE 120	RFC 52 LS 3
OE 124	RFC 52 LZDP 5
OE 124	RFN 58 LZDP 5
OE 127	RFC 62 LS
OE 130	RWC 52 HSK
OE 130	RWC 58 HSEW
OE 137	RFC 42 LS 5
OE 145	RFN 42 LZP
OE 146	FN 68 LZDPR
OE 147	RFC 58 LZE 5
OE 152	RFC 62 LS 5
OE 154	RFC 32 LZ 5
OE 155	RKC 62 JS
OE 163	RN 22 HJSE 6
OE 177	FN 58 LZKFR
OE 177	FN 58 LZKFR 5
OE 175	RFN 42 HZP 5
OE 177	RFC 62 LS4GF 6
OE 186	RZC 62 LS 5
OE 186	RZC 62 LSE
OE 186	RZC 72 LS
OE 197	RZC 58 HST
OE 198	RFN 42 LZG

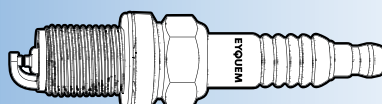
**EYQUEM**

**EYQUEM****CHAMPION**

OE 201	RZC 62 HSET
OE 207	RWC 58 HSE5DP
OE 208	RZC 82 LSDPT
OE 211	RZC 68 HS2
OE 214	FN 68 LZDPR
OE 221	FN 72 HZIPRSO
OE 229	ZN 68 HSTDPR
OE 232	RZC 82 HSDPS
OE 243	RXN 72 HSDPFT
OE 244	ZN 62 LSDPFRSO
OE 245	RXN 72 HSIPFSO
OE 246	FN 72 HZIPRSO
QL 77 JC4	1000
R 10 YCC	RFC 42 LS
R 9 YC	RFC 52 LS
RA2PYPB	RZC 82 LSDPT
RA 4 HCX	RZC 58 LS
RABYCX4	RZC 62 LS 5
RABYCX4	RZC 62 LSE
RABYCX4	RZC 72 LS
RC 9 YC	FC 52 LZWR
RC 10 DMC	RFC 42 LZ 2E
RC 10 PYP4	RFC 52 LZDP 5
RC 10 PYP4	RFN 58 LZDP 5
RC 10 YC	RFC 42 LS
RC 10 YC4	RFC 42 LS 5
RC 10 YCC4	RFC 42 LS 5
RC 10 YCL	RFN 52 LZ
RC 11 LCC4	RFN 42 LZG 5
RC 12 MC4	RFC 32 LZ 5
RC 12 MCC4	RFC 32 LZ 5
RC 12 YC	RFC 42 LS
RC 12 YCC	RFC 42 LS
RC 12 YCC4	RFC 42 LS 5
RC 6 YC	RFC 82 LS
RC 6 YCC	RFC 82 LS
RC 7 BMC	RFC 62 LS 3
RC 7 BYC	RFC 62 LS 3X
RC 7 BYC4	RFC 62 LS 3X
RC 7 YC	RFC 58 LS
RC 7 YC4	RFC 58 LS 5
RC 7 YCC	RFN 58 LZ
RC 7 YCC	RFN 58 LZ 3A
RC 7 YCC4	RFC 58 LS 5
RC 8 BYC	RFC 58 LZ 2
RC 8 DMC	RFC 58 LZ 2E
RC 8 MCC4	RFC 58 LZ 5
RC 8 PYP	RFC 58 LZDP
RC 8 PYP4	RFC 58 LZDP
RC 8 PYPB4	FN 68 LZDPR
RC 8 VTYC4	RFC 58 LZ 3EX
RC 8 VTYC4	RFC 62 LZ 3EX
RC 8 YC	RFC 62 LS
RC 8 YC4	RFC 62 LS 5
RC 8 YCC	RFN 62 LZ
RC 8 YCC4	RFC 62 LS 5
RC 8 YCL	RFN 58 LZ
RC 8 YCL	RFN 58 LZ 3A
RC 87 YCC	RFN 58 LZ
RC 87 YCC	RFN 58 LZ 3A
RC 87 YCL	RFC 58 LZK
RC 87 YCL	RFN 58 LZ
RC 87 YCL	RFN 58 LZ 3A
RC 89 PYC	RFN 42 LZP
RC 89 TMC	RFC 52 LS 3

**EYQUEM****CHAMPION**

RC 89 YCC	RFN 52 LZ
RC 9 BMC	RFC 52 LS 3
RC 9 MCC	RFC 52 LZE
RC 9 MCC4	RFC 58 LZ 5
RC 9 YC4	RFC 52 LS 5
RC 9 YCC	RFN 52 LZ
RC 9 YCC4	RFC 52 LS 5
RC 10 MCC	RFN 42 LZG
RE 14 MCC5	RN 22 HJSE 6
RE 7 PYC5	RC 62 HJSP
REA 8 MCL	RWC 52 HSK
REA 8 PMPB5	RWC 58 HSE5DP
REA 8 MX	RWC 58 HSEW
REA 8 MCL	RWC 58 HSEW
REA 10 MX	RWC 42 HSEW
REC 9 YCL	RFN 58 HZ
REC 9 YCL	RFN 58 HZ 3A
REC 10 PYC4	RFN 42 HZP 5
RERX4ZWPB	RXN 72 HSIPFSO
RERX5ZPYPB	RXN 72 HSDPFT
RER2PYPB	RZC 82 HSDPS
RER 6 DMC	RZC 68 HS2
RER 8 MC	RZC 62 HSET
RER 8 YC	RZC 58 HST
RES 9 PYP4	RC 62 HJSP
RES 9 YCC4	RC 62 HJS 6
RF 7 YC	RKC 62 JS
RF 7 YCC	RKC 62 JS
RF 9 YC	RKC 62 JS
RJ 8 C	500 C
RL 78 C	RC 82
RL 82 YC	RC 62 S
RL 82 YCC	RC 62 S
RL 87 YC	RC 42 S
RN 10 VTYC4	RC 52 LZ 3EX
RN 10 YC	RC 52 LS
RN 10 YC4	RC 52 LS 5
RN 11 YC	RC 32 LS
RN 11 YC4	RC 32 LS 5
RN 11 YCC	RC 32 LS
RN 11 YCC4	RC 32 LS 5
RN 12 YC	RC 30 LS
RN 12 YCC	RC 30 LS
RN 3 C	RC 82 L
RN 4 C	RC 72 L
RN 6 YC	RC 82 LS
RN 6 YCC	RC 82 LS
RN 7 YC	RC 72 LS
RN 7 YC4	RC 72 LS 5
RN 7 YCC	RC 72 LS
RN 7 YCC4	RC 72 LS 5
RN 8 VTYC4	RC 58 LZ 3EX
RN 8 YC	RC 62 LS
RN 9 YC	RC 62 LS
RN 9 YC4	RC 62 LS 5
RN 9 YCC	RC 62 LS
RN 9 YCC4	RC 62 LS 5
RS 7 YC	RC 72 LJS
RS 7 YCC	RC 72 LJS
RS 9 YC	RC 52 LJS
RS 9 YC4	RC 52 LJS 5
RS 9 YCC	RC 52 LJS
RS 9 YCC4	RC 52 LJS 5
RV 15 YC	RC 42 JS
RV 15 YC4	RC 42 JS 5

**EYQUEM****CHAMPION**

S 279 YC	C 72 LJS
S 279 YC4	755 LJS
S 281 YC	755 LJS
S 281 YC	C 62 LJS
S 379YC	C 82 LJS
S 6 YC	C 82 LJS
S 6 YCC	C 82 LJS
S 7 YC	755 LJS
S 7 YC	C 72 LJS
S 7 YCC	C 72 LJS
S 9 YC	C 52 LJS
S 9 YCC	C 52 LJS
UL 4 J	1000
UL 81C	1000
Z 8	RTC 72
Z 9 Y	RTC 72

CHEVROLET

96 464 000	RZC 62 LS
------------	-----------

CHRYSLER

56028189	RFN 42 LZG 5
S2RE 14 MCC5	RN 22 HJSE 6

CITROEN

95 533 994	C 72 LJS
95 605 398	C 62
95 611 941	C 62 LJS
96 009 090	FC 52 LS
96 037 952	FC 42 LS
96 064 890	RFC 42 LS
96 145 071	RFC 58 LS 3
97 533 994	C 72 LJS
0A336275A4	RFC 96 HS3
5960 05	RFN 62 LZ
5960 54	RFN 52 HZ 3A
5960 55	RWC 52 HSK
5960 56	RWC 52 HSK
5960 73	RFN 52 HZ 3A
5960 81	RFN 42 HZDP 5
5960 84	RWC 52 HSK
5960 92	RXC 58 HSEDP
5960 92	RXN 62 HSDP
5960 93	RXC 58 HSEDP
5960 97	RFN 58 HZ 5
5960 A5	RXC 58 HSEDP
5960 C1	RFN 58 LZ 3A
5960 E2	RXC 58 HSEDP
5960 E2	RXN 62 HSDP
5960 F1	RFC 58 LZ 2
5960 G3	RFN 52 HZ 3A
5960 G4	RXC 58 HSEDP
5960 H9	RXC 58 HSEDP
5960 H9	RXN 62 HSDP
5960 J2	RFC 58 LZK
5960 J2	RFN 58 LZ
5960 J3	RFC 58 LZK
5960 J8	RFC 58 LS 3
5960 K1	RFC 62 LS
5960 L2	RFN 58 HZ 5
5960 L3	RXC 42 HSEDP 2A
5960 01	RXC 42 HZGP 5
5962 1A	C 62 LS 3X
5962 1K	RFC 58 LZ 2E
5962 1L	RFC 42 LZ 2E

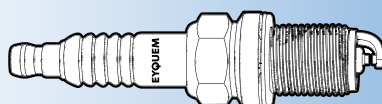

**EYQUEM****CITROEN**

5962 2T	RFC 58 LZ 2
5962 2X	RFC 62 LS
5962 3K	RC 32 LS
5962 3P	RC 42 S
5962 3X	RC 82 LS
5962 3Y	RFC 62 LS 3
5962 4X	RFN 52 LZ
5962 5G	RFN 58 LZ
5962 5G	RFN 58 LZ 3A
5962 5L	RFN 52 HZ
5962 6E	RC 52 LS
5962 6F	RC 52 LS
5962 6L	RFC 58 LZK
5962 6W	RFC 58 LZK
5962 7Q	RFN 58 LZ
5962 7Q	RFN 58 LZ 3A
5962 7S	RFN 58 LZ
5962 7S	RFN 58 LZ 3A
5962 7Y	RFN 58 HZ
5962 7Y	RFN 58 HZ 3A
5962 T0	RFC 58 LS
5962 W1	RFC 52 LS
5962 X8	FC 58 LS
96 357 620 80	RFN 52 LZ
96 494 640 80	RFN 52 HZ 3A
96 73 806 380	RXC 42 HSEDP 2A
96 758 807 80	RXN 72 HSIFFS
96 762 881 80	RZN 32 HSWDP
98 028 401 80	RXC 42 HSEDP 2A
98 077 766 80	RXN 72 HSIFFS

DACIA

22 40 100 32R	RWC 58 HSEW
22 40 115 26R	RWC 42 HSEW
22 40 115 61R	RWC 58 HSEW
22 40 120 47R	RWN 42 HSIPS
22401-2047R	RWN 42 HSIPS
22 40 191 33R	RWN 42 HSIPS
60 02 000 329	RC 42 S
77 00 500 000	C 42 S
77 00 500 155	RFN 58 LZ
77 00 500 155	RFN 58 LZ 3A
77 00 500 168	RFC 58 LZ 2E
82 00 662 185	RWC 52 HSK
82 00 662 185	RWC 58 HSEW

DAEWOO

96 464 000	RZC 62 LS
------------	-----------

DAIHATSU

90048-51163	RFC 58 LZ 5
90048-51178	FN 42 LZDPR 5
90048-51197	RZC 58 LS

DENSO

IKH16	RFN 42 HZP 5
20 EPBR-S	RC 58 LZ 3EX
20 PR-U11	RFC 58 LS 5
DR 14 TC	RFC 62 LS 3X
DR 15 TC	RFC 62 LS 3X
FXE20HR11	RWC 58 HSE5DP
IU22	RTC 62 LSDP
IXEH22TT	RWN 42 HSPW
J 14 CR-U	RC 30 LS
J 14 C-U	C 30 LS

**EYQUEM****DENSO**

J 16 CR-U	RC 52 LZE
J 20 CR-11	RFC 58 LZE 5
K 16 HR-U11	RFN 58 HZ 5
K 16 PR-L11	RFC 52 LS 5
K 16 PR-U	RFC 52 LS
K 16 PR-U11	RFC 52 LS 5
K 16 P-U	FC 52 LS
K 16 R-U	RFC 58 LZ
K 16 R-U11	RFC 58 LZ 5
K 20 HR-U11	RFC 58 HZEDP 5
K 20 PBR	RFC 62 LS 3X
K 20 PBR-S10	RFC 58 LZ 3EX
K 20 PR-L11	RFC 62 LS 5
K 20 PR-U	RFC 58 LS
K 20 PR-U11	RFC 58 LS 5
K 20 R-U	RFC 58 LZ
K 20 R-U11	RFC 58 LZ 5
K 20 TR-11	RFC 58 LZ 5
K 22 PR-U11	RFC 62 LS 5
K 20 PBR-S10	RFC 62 LS4GF 6
KJ 16 CR-11	RFC 52 LZE
KJ 20 CRL-11	RFC 58 LZE 5
KJ 20 DR-M11	FN 58 LZKFR 5
MA 14 P-U	RKC 62 JS
MA 16 PR-U	RKC 62 JS
MA 17 P-U	RKC 62 JS
MA 20 PR-U	RKC 62 JS
PK20 PR-L11	RFN 58 LZDP 5
PK20 PR-P8	RFN 58 LZDP
PK20PR-L11	RFC 62 LSDP 5
Q 14 R-U11	RFC 42 LS 5
Q 16 PR-U	RFC 52 LS
Q 16 PR-U11	RFC 52 LS 5
Q 16 P-U11	RFC 52 LS 5
Q 16 R-U	RFC 42 LS
Q 16 R-U11	RFC 52 LS 5
Q 16 U	FC 42 LS
Q 20 PR-U	RFC 58 LS
Q 20 PR-U11	RFC 58 LS 5
Q 20 P-U	FC 58 LS
Q 20 R-U	RFC 58 LS
Q 20 R-U11	RFC 58 LS 5
Q 20 U	FC 58 LS
Q 22 PR-U	RFC 82 LS
Q 22 PR-U11	RFC 82 LS 5
QJ 16 AR-U	RFN 42 LZG 5
QJ 16 CR-11	RFC 52 LZE
QJ 16 CR-U11	RFC 52 LZE
QJ 20 CR-11	RFC 58 LZE 5
QJ 20 CR-U11	RFC 58 LZE 5
SC16HR11	RWN 42 HSI PW
SC20HR11	RWN 42 HSI PW
SKJ20CR-A8	FC 62 LSDPR
SVK20RZ-11	FN 42 LZDPR 5
SXU22 HDR8	ZN 68 HSTDPR
T 16 EPR-U	RC 52 LJS
T 16 EX-U	C 52 LJS
T 20 EPR-U	RC 62 LJS
T 20 EPR-U11	RC 62 LJS 5
T 20 EP-U	C 62 LJS
T 20 EX-U	C 62 LJS
T 20 M-U	R 500 CJT
T 20 PR-U	RC 42 JS
T 22 EP-U	C 82 LJS
T 22 M-U	R 755 CJT

**EYQUEM****DENSO**

TR 22	RC 72
TR 24	RC 82
TU 22	RTC 62 LSDP
U 20 FSR-U	RTC 68
U 22 ESR-N	RTC 72L
U 22 FS-L	RTC 72
U 22 FSR-L	RTC 72
U 22 FSR-U	RTC 72
U 22 FS-U	RTC 72
VK22	FN 68 LZDPR
VXUH22	RXN 62 HSEP
W 14 EP	C 32 LS
W 14 EPR-U	RC 32 LS
W 14 EPR-U11	RC 32 LS 5
W 14 EP-U	C 32 LS
W 14 EXR-U	RC 32 LS
W 14 EXR-U11	RC 32 LS 5
W 14 EX-U	C 32 LS
W 14 EX-U11	RC 32 LS 5
W 14 F	C 32
W 14 FP	C 32 S
W 14 FP-L	C 32 S
W 14 FP-U	C 32 S
W 14 FP-UL	C 32 S
W 14 F-U	200
W 14 LM-U	R 502 CT
W 14-US	500 C
W 16 EP	C 52 LS
W 16 EPB-10	C 52 LS 3X
W 16 EPR	RC 52 LS
W 16 EPR-U	RC 52 LS
W 16 EPR-U10	RC 52 LS 5
W 16 EPR-U11	RC 52 LS 5
W 16 EP-U	C 52 LS
W 16 EX	C 52 LS
W 16 EXR-U	RC 52 LS
W 16 EXR-U11	RC 52 LS 5
W 16 EX-U	C 52 LS
W 16 EX-U11	RC 52 LS 5
W 16 FP	C 32 S
W 16 FP-U	C 32 S
W 16 FS	C 32
W 16 FS-U	C 32
W 16 PR-U	RC 42 S
W 16 S-U	500 C
W 19 LM-US	R 202 CT
W 2 FP-U	C 62 S
W 20 EP	C 62 LS
W 20 EPB	C 62 LS 3X
W 20 EPBR-S	RC 58 LZ 3EX
W 20 EPR	RC 62 LS
W 20 EPR-U	RC 62 LS
W 20 EPR-U10	RC 62 LS 5
W 20 EPR-U11	RC 62 LS 5
W 20 EP-U	C 62 LS
W 20 ES	C 72 L
W 20 ESR-U	RC 72 L
W 20 ES-U	C 72 L
W 20 ET	C 72 LS
W 20 EX	C 62 LS
W 20 EXR-U	RC 62 LS
W 20 EXR-U11	RC 62 LS 5
W 20 EX-U11	RC 62 LS 5
W 20 FP	C 42 S
W 20 FPR	RC 42 S

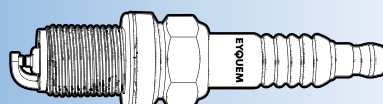

**EYQUEM****DENSO**

W 20 FPR-U	RC 42 S
W 20 FP-U	C 42 S
W 20 FS	C 42
W 20 FS-U	C 42
W 20 S	500 C
W 20 S-U	500 C
W 202 EX-U	C 62 LS
W 22 EP	C 82 LS
W 22 EP-11	RC 82 LS 5
W 22 EPB	C 82 LS 3X
W 22 EPR-U	RC 82 LS
W 22 EPR-U11	RC 82 LS 5
W 22 EP-U	C 82 LS
W 22 ESR	RC 72 L
W 22 ESR-U	RC 72 L
W 22 EXR-U	RC 82 LS
W 22 EXR-U11	RC 82 LS 5
W 22 EX-U	C 82 LS
W 22 FP	C 62 S
W 22 FPR	RC 62 S
W 22 FPR-U	RC 62 S
W 22 FS	C 72
W 22 FSR	RC 72
W 22 FSR-U	RC 72
W 22 FS-U	C 62
W 22 FS-U	C 72
W 22 M	R 755 CT
W 22 MP-US	R 700 CTS
W 22 M-U	R 755 CT
W 22 M-US	R 755 CT
W 24 EP	C 92 LS
W 24 EP-U	C 92 LS
W 24 ES	C 82 L
W 24 ESR	RC 82 L
W 24 ESR-U	RC 82 L
W 24 ES-U	C 82 L
W 24 ES-ZU	805 LP
W 24 FS	C 82
W 24 FSR	RC 82
W 24 FS-U	C 82
W 9 LMR-US	R 202 CT
W 9 LMR-US	R 202 CT
WA 20 M	R 500 CJT
WA 20 M-U	R 500 CJT
WA 22 M	R 755 CJT
WA 22 M-U	R 755 CJT
XE20HRU9	RWC 52 HSK
XU22EPR-U	RZC 62 LS 5
XU22EPR-U	RZC 62 LSE
XU22EPR-U	RZC 62 LS
XU22HDR9	RZC 62 HSET
XU24EPR-U	RZC 72 LS
ZT20EPR11	RN 62 LJZDP 6
ZT20EPR11	RN 62 LJZEDP 6
ZXU20PR11	RZC 62 LSDP 5K

FIAT

46461873	RZC 58 LS
46531917	RZC 58 LS
46531919	RZC 58 LS
46750545	RZC 58 LS
46750545	RZC 72 LS
46799928	RZC 58 LS
46823299	RZC 58 LS
55188857	RZC 58 LS

**EYQUEM****FIAT**

55188857	RZC 62 LS 5
55190788	RZC 62 LSE
55198201	RZC 58 LS
55210685	RZC 82 LSDPT
552106850	RZC 82 LSDPT
55229633	RZC 82 HSDPS
55233997	RZC 82 HSDPS
71377139	RZC 58 LS
9628000280	RFC 58 LZ 2E

FORD

1000996	RFC 62 LSDP 5
1023706	FN 42 LZDPR 5
1086020	RFN 58 LZDP 5
1086720	FN 42 LZDPR 5
1 088 847	RC 62 HJS 6
1 097 080	RC 62 HJS 6
1 120 170	RFN 52 LZDPF 5
1 125 332	FN 42 LZDPR 5
1 128 053	RN 62 LJZDP 6
1 202 935	RC 62 HJS 6
1 204 572	RN 62 LJZDP 6
1 233 897	RC 62 HJS 6
1 255 464	RC 62 HJS 6
1 307 093	RN 62 LJZDP 6
1 315 691	RN 62 LJZDP 6
1 327 341	RC 62 HJS 6
1 335 367	RC 62 HJS 6
1 350 742	RC 62 HJS 6
1 362 012	RC 62 HJS 6
1369704	RN 62 LJZEDP 6
1 493 001	RC 62 HJS 6
1 542 499	RZC 62 LSE
6 726 180	RC 62 HJSP
1M50 12405 CA	RC 62 HJS 6
1S7J 12405 DA	RN 62 LJZDP 6
1S7J 12405 EB	RN 62 LJZDP 6
2U7J 12405 AA	RC 62 HJS 6
4M5G 12405 XA	RC 62 HJS 6
4M5G 12405 XB	RC 62 HJS 6
4M5G 12405 XC	RC 62 HJS 6
5M5G12405AA	RN 62 LJZEDP 6
959 F 12405 AA	RFC 62 LSDP 5
95WF 12405 AB	FN 42 LZDPR 5
96 XF 12405 BB	RFN 58 LZDP 5
XS6F 12405 BA	RC 62 HJS 6
XS6F 12405 CA	RC 62 HJS 6
YN2F 12405 AA	RC 62 HJS 6
YN2J 12405 AA	RC 62 HJS 6

GENERAL MOTORS

25 324 618	RC 42 HJS 3E5
93161199	RFN 58 LZDP
93 193 723	RZC 62 LSDP 5K

HONDA

98079-5514G	RFC 52 LZE
98079-5515G	RFC 52 LZE
98079-561-4E	RFC 52 LZE 5
98079-5614E	RFC 58 LZE 5
98079-5614G	RFC 58 LZE 5
98079-5614N	FN 42 LZDPR 5
98079-5614P	RFC 58 LZE 5
98079-5615V	FN 42 LZDPR 5
12290-RSH 003	FN 42 LZDPR 5

**EYQUEM****HONDA**

12290-RSH 004	FN 42 LZDPR 5
---------------	---------------

HYUNDAI

17710- 12930	FN 42 LZDPR 5
1 882 911 050	RFC 58 LZE 5
18817-11051	RFN 58 LZDP 5
18826-11101	RFN 58 LZDP 5
18827-09080	RZC 58 HST
18841-11051	RFN 52 HZ 5
18843-10062	RZC 58 HST
18854-09080	RZC 62 HSET

INFINITI

22401-00Q0K	RWN 42 HSIPS
-------------	--------------

KAWAZAKI

92070-1129	RTC 72
92070-1183	RTC 72
J4520-IUF22	RTC 72

KIA

18827-09080	RZC 58 HST
18841-11051	RFN 52 HZ 5
18843-10062	RZC 58 HST
18854-09080	RZC 62 HSET

LANCIA

9628000280	RFC 58 LZ 2E
------------	--------------

LEXUS

90919-01253	RWN 42 HSIPW
-------------	--------------

MAGNETI MARELLI

6 LC	FC 42 LS
6 LC1R	RFC 42 LS 5
7 LC	FC 52 LS
7 LC1R	RFC 52 LS 5
7 LCR	RFC 52 LS
7 LPR	RFC 52 LS
8 LC	FC 62 LS
8 LC1R	RFC 58 LS 5
8 LCR	RFC 62 LS
9 LC	RFC 82 LS
9 LCR	RFC 82 LS
C 9 L	C 82 L
CW 4 N	200
CW 5 N	C 32
CW 5 NP	C 32 S
CW 6 LP	C 52 LS
CW 6 LPR	RC 52 LS
CW 6 N	502
CW 6 N	C 42
CW 6 NP	C 42 S
CW 67 LP	C 52 LS
CW 7 LP	C 62 LS
CW 7 LPR	RC 62 LS
CW 7 N	C 62
CW 7 NP	C 62 S
CW 7 NPR	RC 62 S
CW 75 LP	755 LS
CW 78 LP	C 82 LS
CW 78 LPR	RC 82 LS
CW 8 L	C 82 L
CW 8 LP	C 82 LS
CW 8 N	C 82



**EYQUEM****MAGNETI MARELLI**

CW 9 LP	C 92 LS
CW 9 N	C 82
CWC 12 NJ	C 82
F 4 LC	C 30 LS
F 4 LCR	RC 30 LS
F 45 LCR	RC 32 LS
F 45 LDCR	RC 32 LS
F 6 NC	C 42 S
F 6 NCR	RC 42 S
F 7 LC	C 62 LS
F 7 LDC	C 62 LS
F 7 LMC	C 62 LS 3X
F 7 NC	C 62 S
F 7 NCR	RC 62 S
F 7 NDCR	RC 62 S
F 75 LMC1R	RC 58 LZ 3EX
F 8 LC	C 72 LS
F 8 LCR	RC 72 LS
F 8 LDC	C 72 LS
F 9 LC	C 82 LS
F 9 LDC	C 82 LS
FC 6 N	C 32
FL 8 LCR	RC 72 LS
L 6 LSCR	RFC 42 LZ 2E
L 7 LCR	RFC 52 LS
L 75 LSCR	RFC 58 LZ 2E
L 8 LCR	RFC 58 LS
T 7 LC	C 52 LJS
T 7 LCR	RC 52 LJS
T 70 LDC	C 52 LJS
T 8 LC	C 72 LJS
T 8 LCR	RC 72 LJS
T 8 LDC	C 72 LJS
T 9 LDC	C 82 LJS
TW 7 LP	C 52 LJS
TW 78 LP	C 72 LJS

MAZDA

1A02-18-110	RZC 58 LS
C 401-18-110	RC 62 HJS 6
C 402-18-110 A	RC 62 HJS 6
C 402-18-110A	RC 62 HJS 6
F 20118101	RFC 58 LZE 5
F 285 18 110	RFC 58 LZE 5
F 286 18 110	RFC 58 LZE 5
F 287 18 110	RFC 58 LZE 5
F 288 18 110	RFC 58 LZE 5
JE 41 18 110	RFN 58 LZDP 5
L813 18 110	RN 62 LJZEDP 6

MERCEDES-BENZ

003 159 66 03	FN 42 LZDPR 5
003 159 94 03	FN 42 LZDPR 5
004 159 13 03	RFN 62 HZDP
004 159 19 03	FN 42 LZDPR 5
004 159 23 03	RFN 62 HZDP
004 159 26 03	FC 52 LZWR
004 159 30 03	FC 52 LZWR
004 159 36 03	FC 52 LZWR
004 159 45 03	RFN 62 HZDP
05 098 167 AA	FN 42 LZDPR 5
A 003 159 66 03	FN 42 LZDPR 5
A 003 159 94 03	FN 42 LZDPR 5
A 004 159 13 03	RFN 62 HZDP
A 004 159 18 03	ZN 68 HSTDPR

**EYQUEM****MERCEDES-BENZ**

A 004 159 19 03	FN 42 LZDPR 5
A 004 159 19 03 26	FN 42 LZDPR 5
A 004 159 23 03	RFN 62 HZDP
A 004 159 26 03	FC 52 LZWR
A 004 159 30 03	FC 52 LZWR
A 004 159 34 03	ZN 68 HSTDPR
A 004 159 36 03	FC 52 LZWR
A 004 159 44 03	ZN 68 HSTDPR
A 004 159 45 03	RFN 62 HZDP
A 004 159 30 03 26	FC 52 LZWR
A 004 159 45 03 26	RFN 62 HZDP
A 004 159 49 03	ZN 68 HSTDPR

MINI

0 041 666	RXN 72 HSIPFSO
12120034098	RXC 58 HSEDP
12122158165	RXC 58 HSEDP
V 75 70 259	RXC 62 HSEDP
V 75 77 104	RXC 62 HSEDP
12 12 0 034 098	RXN 62 HSDP
12 12 0 041 666	RXN 72 HSIPFSO
12 12 2 293 697	RXN 62 HSDP

MITSUBISHI

MA 848 593	RFC 58 HZEDP 5
MD 313 443	RFN 58 LZDP 5
MD 360 383	RFC 42 LZDP
MN 128 362	RFC 58 HZEDP 5
MN 128 363	RFC 58 HZEDP 5
MS 851 336	RFN 58 LZDP 5
MS 851 473	RFN 58 LZDP 5
MS 851 502	RFN 58 LZDP 5

MOTORCRAFT

A 2 NX	R 755 CT
A 3 CU	R 500 CT
A 3 NX	500 C
A 3 X	500 C
A 5	500 C
A 5 CU	500 C
A 5 X	500 C
A 7 N	R 500 CT
A 7 NU	R 500 CT
A 7 NX	R 500 CT
AE 1	C 82
AE 1C	C 72
AE 1X	C 72
AE 2	C 62
AE 2 C	C 62
AE 2 X	C 62
AE 22	C 62 S
AE 22 C	C 62 S
AE 3	C 42
AE 3 C	705 S
AE 3 C	C 42
AE 3 X	C 42
AE 32	C 42 S
AE 32 C	C 42
AE 4 X	C 32
AE 42	C 32 S
AE 42 C	C 32 S
AE 4C	C 32 S
AE 6	C 32
AE 6 C	600 S
AE 6 C	C 32 S

**EYQUEM****MOTORCRAFT**

AE 62	C 32 S
AE 8	200
AER 22 C	RC 62 S
AER 32	RC 42 S
AER 32 C	RC 42 S
AF 3 NX	R 755 CJT
AF 5 NX	R 500 CJT
AG 1	C 82 L
AG 1 C	C 82 L
AG 1 X	C 82 L
AG 12	C 82 LS
AG 12 C	C 82 LS
AG 12 CU	C 82 LS
AG 2 C	C 72 LS
AG 22	C 62 LS
AG 22 C	C 62 LS
AG 22 CU	C 62 LS
AG 32	C 62 LS
AG 32 A	C 62 LS
AG 32 C	C 62 LS
AG 32 U	C 62 LS
AG 52	C 52 LS
AG 52 C	C 52 LS
AG 82	C 32 LS
AG 902	C 92 LS
AGF 12	C 72 LJS
AGF 12 C	C 72 LJS
AGF 22	C 52 LJS
AGF 22 C	C 52 LJS
AGF 32 CU	C 52 LJS
AGN 42	C 52 LS
AGP 22 C	FC 62 LS
AGP 22 CD	FC 62 LS
AGP 32 C	FC 52 LS
AGPR 12 C	RFC 82 LS
AGPR 12 CD	RFC 82 LS
AGPR 22 C	RFC 62 LS
AGPR 22 C1	RFC 58 LS 5
AGPR 22 CD	RFC 58 LS
AGPR 22 CD1	RFC 58 LS 5
AGPR 32 C	RFC 52 LS
AGPR 32 C1	RFC 52 LS 5
AGPR 32 CD1	RFC 52 LS 5
AGR 1 X	RC 72 LS
AGR 12	RC 72 LS
AGR 12 C	RC 82 LS
AGR 2 C	RC 72 L
AGR 22	RC 62 LS
AGR 22 C	RC 62 LS
AGR 22 CU	RC 62 LS
AGR 252	RC 62 LS
AGR 252 C	RC 62 LS
AGR 32	RC 52 LS
AGR 32 C	RC 52 LS
AGR 32 CU	RC 52 LS
AGR 34 CU	RC 52 LS
AGR 42	RC 32 LS
AGR 42 C	RC 32 LS
AGR 42 CU	RC 32 LS
AGR 44 CU	RC 32 LS
AGR 52	RC 52 LS
AGRF 22	RC 52 LJS
AGRF 22 C	RC 52 LJS
AGRF 22 C1	RC 52 LJS 5
AGRF 22 CD	RC 52 LJS

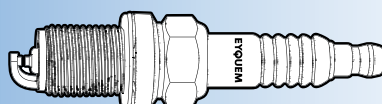
**EYQUEM**

**EYQUEM****MOTORCRAFT**

AGRF 22 CD1	RC 52 LJS 5
AGRF 32	RC 52 LJS
AGS 12 C	RC 82 LS
AGS 22 C	RC 62 LS
AGS 32	C 52 LS
AGS 32 C	RC 52 LS
AGS 32 C1	RC 52 LS 5
AGS 33 C	C 30 LS
AGS 42 C	RC 32 LS
AGSF 12	RC 72 LJS
AGSF 22 C	RC 52 LJS
AGSF 32 C	RC 52 LJS
AGSF 42 C6	RC 22 LJZ 7
AGSP 32 C	RFC 42 LS 5
ARF 42	RC 42 JS
ASF32	RC 42 JS 5
AT 3	500 C
AT 4	500 C
AT 6	500 C
AV 1 X	C 82
AV 2 CU	C 72
AV 2 X	C 72
AV 42	C 32 S
AV 52	C 32 S
AWRF 32	RC 62 LJS
AWRF 42	RC 52 LJS
AWSF 22 C	RC 62 LJS
AWSF 32	RC 62 LJS
AWSF 32 C	RC 62 LJS
AWSF 42	RC 52 LJS
AWSF 42 C	RC 52 LJS
AZ 3	500 C
BRF 22 C	RKC 62 JS
BRF 22 CX	RKC 62 JS
BRF 32 C	RKC 62 JS
BRF 32 CX	RKC 62 JS
PV2	RTC 72

NGK

304	R 700 CTS
308	R 700 CTS
309	R 700 CTS
1208	RFC 58 HZEDP 5
1578	RZC 62 HSET
1675	FN 68 LZDPR
1691	RZC 62 LSE
1691	RZC 58 LS
2262	RFC 58 LZE 5
2288	RFC 58 LZ 2E
2364	600 LS
2397	RFC 58 LZ 3EX
2412	755 LS
2467	RC 62 HJSP
2621	1000
2621	850
2647	RFN 58 LZDP 5
2890	RFC 42 LZ 4E
3014	1000
3014	850
3172	RC 58 LZ 3EX
3199	RFC 58 LZP 4
3210	500 C
3311	600 S
3355	755 LS
3510	500 C

**EYQUEM****NGK**

3586	RFN 52 LZDPF 5
3588	RFN 62 HZDP
3611	600 S
3688	RFC 62 LSDP 5
3783	RFC 58 LS
3812	C 62 LJS
3975	600 S
3978	RFN 62 LZDP 5
4080	RFC 42 LZDP
4110	200
4114	RFC 42 HZDP 5
4210	502
4259	RTC 62 LSDP
4259	RTC 62 LSDP
4288	ZN 68 HSTDPR
4292	FN 42 LZDPR 5
4293	FC 52 LZWR
4294	RFN 58 LZDPE5
4339	RZC 62 LS
4345	R 700 CTS
4377	RFN 58 LZDP
4377	RFN 62 LZDP 5
4435	RFC 58 LZF 5
4477	RN 62 LJZEDP 6
4510	C 42 S
4511	600 S
4511	C 42 S
4559	RC 62 HJS 6
4619	RFN 58 LZ
4626	R 700 CTS
4629	RTC 72
4632	705 S
4641	RFN 58 LZDP 5
4691	C 52 LS
4775	RFN 42 HZP 5
4793	RFN 62 LZDP 5
4912	RWN 42 HSI PW
4968	RN 62 LJZDP 6
4983	RZC 62 LS 5
5030	RFC 82 LS
5118	RWC 58 HSE5DP
5214	RZC 68 HS2
5328	755 LS
5510	1000
5510	850
5539	1000
5539	850
5555	RFN 62 LZDP 5
5598	RN 62 LJZDP 6
5613	RFN 42 HZP 5
5637	707 LS
5637	750 LS
5692	RZC 72 LS
5756	RZC 82 LSDPT
5758	FC 62 LSDPR
5788	RFN 58 HZ 5
5809	RN 62 LJZEDP 6
5811	600 LS
5843	RXC 42 HSEDP 2A
5843	RXC 58 HSEDP
5843	RXN 62 HSDP
5942	RWC 52 HSK
5942	RWC 58 HSEW
5960	FN 58 LZKFR 5
5987	RFC 58 HZEDP 5

**EYQUEM****NGK**

6002	RFC 52 LZ 4E
6211	707 LS
6240	RFN 42 HZDP 5
6376	RFN 52 HZ5
6411	707 LS
6411	750 LS
6449	RFC 62 LS4GF 6
6511	600 LS
6511	C 52 LS
6643	RWC 58 HSE5DP
6651	RZC 58 LS
6677	RFN 58 HZ
6717	RFN 58 LZ
6726	R 700 CTS
6872	RFC 52 LZ 4E
6893	FN 58 LZKFR
6962	RFC 58 LS
6986	RN 62 LJZDP 6
7113	RFN 52 HZ
7223	RTC 72
7327	600 LS
7422	RC 52 LS
7496	FC 42 LS
7569	RN 62 LJZDP 6
7642	RFN 52 LZ
7658	RFN 62 LZDP 5
7727	707 LS
7727	750 LS
7742	FN 62 LZFDPR 2A
7811	707 LS
7811	750 LS
7811	C 62 LS
7822	RC 62 LS
7956	RFC 42 LZ 2E
8894	RFN 42 LZG
90061	RWN 42 HSI PS
90223	RXN 62 HSDP
91121	RWN 42 HSI PS
91432	RWC 62 HSDPS
93311	RZC 82 LSDPT
94201	RXN 72 HSI PFSO
94716	ZN 68 HSTDPR
94833	FN 72 HZI PRSO
94968	ZN 62 LSDPFRSO
94951	RWC 58 HSEW
96209	FN 72 LZIPFRS
96569	RZC 58 HST
97153	FN 68 LZIPFRS
97168	RZC 82 HSDPS
97506	RXN 72 HSDPFT
97999	RZN 32 HSWDP
7980	RZC 62 LSDP 5K
AP 5 FS	RKC 62 JS
AP 6 FS	RKC 62 JS
APR 5 FS	RKC 62 JS
APR 6 FS	RKC 62 JS
B 4	500 C
B 4 H	200
B 4 H-10	200
B 4 HS	200
B 4 L	200
B 5 HS	502
B 5 HS	C 42
B 6	500 C
B 6 HS	C 42 S

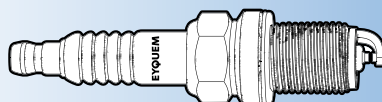

**EYQUEM****NGK**

B 6 HSA	705 S
B 6 S	500 C
B 7 ES	C 72 L
B 7 H	1000
B 7 H	850
B 7 H	C 62
B 7 HS	C 62
B 7 HS	C 72
B 7 HV	1000
B 7 HV	850
B 7 HZ	1000
B 7 HZ	C 62
B 7 S	500 C
B 8 ES	C 82 L
B 8 EV	805 LP
B 8 EVX	805 LP
B 8 H	1000
B 8 H	850
B 8 HCS	1000
B 8 HCS	850
B 8 HS	1000
B 8 HS	850
B 8 HS	C 82
B 8 HS-10	850
BCP 4 ES	FC 42 LS
BCP 4 ES-11	RFC 42 LS 5
BCP 5 E	FC 52 LS
BCP 5 ES	FC 52 LS
BCP 5 ES-11	RFC 52 LS 5
BCP 6 E	FC 58 LS
BCP 6 E-11	RFC 58 LS 5
BCP 6 ES	FC 58 LS
BCP 6 ES-11	RFC 58 LS 5
BCP 6 ET	FC 62 LS 3X
BCP 6 EY	RFC 58 LZ
BCP7 ES	RFC 82 LS
BCPR 5EY-11	RFC 52 LS 5
BCPR 4 ES	RFC 42 LS
BCPR 4 ES-11	RFC 42 LS 5
BCPR 4 EY-11	RFC 42 LS 5
BCPR 5 E	RFC 52 LS
BCPR 5 E-11	RFC 52 LS 5
BCPR 5 ES	RFC 52 LS
BCPR 5 ES-11	RFC 52 LS 5
BCPR 5 EY	RFC 52 LS
BCPR 6 E	RFC 58 LS
BCPR 6 E-11	RFC 58 LS 5
BCPR 6 ES	RFC 58 LS
BCPR 6 ES-11	RFC 58 LS 5
BCPR 6 ET	RFC 62 LS 3X
BCPR 6 EY	RFC 58 LZ
BCPR 6 EY-11	RFC 58 LZ 5
BCPR 7 E	RFC 82 LS
BCPR 7 E-11	RFC 82 LS 5
BCPR 7 ES	RFC 82 LS
BCPR 7 ES-11	RFC 82 LS 5
BCPR 7 EY	RFC 82 LS
BCPR 7 EY-11	RFC 82 LS 5
BCRE 527 Y	RFN 42 LZG 5
BK 5 E	FC 52 LS
BK 5 ESZ	FN 52 LS
BK 6 E	FC 58 LS
BK 6 E-11	RFC 58 LS 5
BK 7 E-11	RFC 82 LS 5
BKR 4 E	RFC 42 LS

**EYQUEM****NGK**

BKR 4 E-11	RFC 42 LS 5
BKR 4 ES	RFC 42 LS
BKR 4 ES-11	RFC 42 LS 5
BKR 4 EY	RFC 42 LS
BKR 4 EY-11	RFC 42 LS 5
BKR 5 E	RFC 52 LS
BKR 5 E-11	RFC 52 LS 5
BKR 5 EK	RFC 42 LZ 2E
BKR 5 EKU	RFC 52 LS 3
BKR 5 EKUP	RFC 42 LZ 4E
BKR 5 ES	RFC 52 LS
BKR 5 ES-11	RFC 52 LS 5
BKR 5 ESZ	FN 52 LS
BKR 5 EY	RFC 52 LS
BKR 5 EY-11	RFC 52 LS 5
BKR 5 EYA	RFC 58 LZ
BKR 5 EYA-11	RFC 58 LZ 5
BKR 5 EZ	RFN 52 LZ
BKR 6 E	RFC 58 LS
BKR 6 E-11	RFC 58 LS 5
BKR 6 EK	RFC 58 LZ 2E
BKR 6 EKC	RFC 58 LZ 2
BKR 6 EKPA	RFC 58 LZP 4
BKR 6 EKUB	RFC 58 LS 3
BKR 6 EN-11	RFC 58 LS 5
BKR 6 EP-13	RFC 52 LZDP 6
BKR 6 EP-8	RFC 52 LZDP
BKR 6 EQU	RFC 52 LZ 4E
BKR 6 EQUA	RFC 52 LZ 4E
BKR 6 EQUP	RFC 58 LZP 4
BKR 6 ES	RFC 58 LS
BKR 6 ES-11	RFC 58 LS 5
BKR 6 ET-10	RFC 58 LZ 3EX
BKR 6 EVX-11	RFC 58 LZ
BKR 6 EY	RFC 58 LZ
BKR 6 EY-11	RFC 58 LZ 5
BKR 6 EYA	RFC 58 LZ
BKR 6 EYA-11	RFC 58 LZ 5
BKR 6 EZ	RFN 58 LZ
BKR 6 EZ	RFN 58 LZ 3A
BKR 6 EZB	FC 52 LZWR
BKR 6 N-11	RFC 58 LS 5
BKR 7 E	RFC 82 LS
BKR 7 E-11	RFC 82 LS 5
BKR 7 ES-11	RFC 82 LS 5
BKR 7 EVX	RFN 62 LZ
BKR 7 EY	RFC 82 LS
BKUR 6 EK	RFC 58 LZ 2
BKUR 5 ET	F 54
BKUR 6 ET	RFC 58 LZ 3EX
BKUR 6 ET-10	RFC 58 LZ 3EX
BKUR 7 ET	RFC 62 LZ 3EX
BM 6 A	R 500 CT
BM 6 F	R 500 CJT
BM 7 A	R 755 CT
BM 7 F	R 755 CJT
BMR 6 D	R 700 CTS
BP 4 E	600 LS
BP 4 ES	C 32 LS
BP 4 ES-11	RC 32 LS 5
BP 4 EY	C 30 LS
BP 4 H	600 S
BP 4 HS	600 S
BP 4 HS-10	600 S
BP 5 E	600 LS

**EYQUEM****NGK**

BP 5 E	C 52 LS
BP 5 EA	600 LS
BP 5 EA	C 52 LS
BP 5 EA-L	707 LS
BP 5 EA-L	750 LS
BP 5 EA-L-11	707 LS
BP 5 EA-L-11	750 LS
BP 5 EFS	C 52 LJS
BP 5 ES	600 LS
BP 5 ES	C 52 LS
BP 5 ES-13	600 LS
BP 5 ES-L	707 LS
BP 5 ES-L	750 LS
BP 5 ESZ	C 52 LS
BP 5 ET	C 62 LS 3X
BP 5 ET-10	C 62 LS 3X
BP 5 EY	600 LS
BP 5 EY	C 52 LS
BP 5 EZ	600 LS
BP 5 EZ	C 52 LS
BP 5 HS-10	600 S
BP 5EY-11	RC 52 LS 5
BP 6 E	707 LS
BP 6 E	750 LS
BP 6 E	C 62 LS
BP 6 EF	C 62 LJS
BP 6 EFS	755 LJS
BP 6 EFS	C 62 LJS
BP 6 ES	707 LS
BP 6 ES	750 LS
BP 6 ES	C 62 LS
BP 6 ET	C 72 LS 3X
BP 6 EY	707 LS
BP 6 EY	750 LS
BP 6 EY	C 62 LS
BP 6 EY-11	707 LS
BP 6 EY-11	750 LS
BP 6 EZ	707 LS
BP 6 EZ	750 LS
BP 6 EZ	C 62 LS
BP 6 H	600 S
BP 6 H	C 42 S
BP 6 HS	600 S
BP 6 HS	C 42 S
BP 6 HS-10	600 S
BP 6 HSA	705 S
BP 6 HSA	C 42 S
BP 7 E	C 82 LS
BP 7 EFS	C 72 LJS
BP 7 EFX	805 LJSP
BP 7 ES	C 82 LS
BP 7 ES-11	RC 82 LS 5
BP 7 ET	C 82 LS 3X
BP 7 EY	755 LS
BP 7 EY	C 82 LS
BP 7 EY-11	755 LS
BP 7 HS	C 62 S
BP 8 ES	C 92 LS
BPC 5 E	FC 52 LS
BPM 6 A	R 700 CTS
BPMR 6 A	R 700 CTS
BPR 4 E	RC 32 LS
BPR 4 E-11	RC 32 LS 5
BPR 4 ES	RC 32 LS

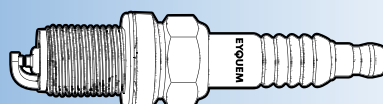

**EYQUEM**

NGK	
BPR 4 ES-11	RC 32 LS 5
BPR 4 EY	RC 32 LS
BPR 4 EY-11	RC 32 LS 5
BPR 5 E	RC 52 LS
BPR 5 E-11	RC 52 LS 5
BPR 5 EA	RC 52 LS
BPR 5 EA-11	RC 52 LS 5
BPR 5 ES	RC 52 LS
BPR 5 ES-11	RC 52 LS 5
BPR 5 EY	RC 52 LS
BPR 5 EY-11	RC 52 LS 5
BPR 5 EZ	RC 52 LS
BPR 5 FS-11	RC 42 JS
BPR 6 E	RC 62 LS
BPR 6 E-11	RC 62 LS 5
BPR 6 EF	RC 62 LJS
BPR 6 EFS	RC 62 LJS
BPR 6 ES	RC 62 LS
BPR 6 ES-11	RC 62 LS 5
BPR 6 EY-11	RC 62 LS 5
BPR 6 FS	RC 42 JS
BPR 6 HS	RC 42 S
BPR 6 HSA	705 S
BPR 7 E	RC 82 LS
BPR 7 ES	RC 82 LS
BPR 7 ES-11	RC 82 LS 5
BPR 7 EY	RC 82 LS
BPR 7 EY-11	RC 82 LS 5
BPR 7 HS	RC 62 S
BR 6 EY	RC 62 LS
BR 7 ES	RC 72 L
BR 7 HS	RC 72
BR 8 ES	RC 82 L
BR 8 HS	RC 82
BR 8 HS-10	RC 82
BR 8 HSA	1000
BR 8 HSA	850
BU 5 EB-11	755 LS
BU 6 EA-11	755 LS
BUR 5 ET	RC 52 LZ 3EX
BUR 5 ET-11	RC 52 LZ 3EX
BUR 6 EFSZ	RC 52 LJS 4E
BUR 6 ET	RC 58 LZ 3EX
C 7 HS	RTC 72
C 7 HSA	RTC 72
CR 6 HSA	RTC 68
CR 7 E	RTC 72L
CR 7 HS	RTC 72
CR 7 HSA	RTC 72
DCPR7EA-9	RZC 58 LS
DCPR7E-N-10	RZC 62 LS 5
DCPR8E	RZC 62 LS
DCPR8E-N	RZC 72 LS
GR 4	RC 22 LZ
IFR6J11	RFN 62 LZDP 5
IKR6G11	RZC 62 LSDP 5K
IKR9F8	RZC 82 LSDPT
IKR9J8	RZC 82 LSDPT
ILFR6A	RFN 62 HZDP
ILKAR7A7	RWC 62 HSDPS
ILKAR7B11	RWN 42 HSI PW
ILKAR7F7G	RWN 42 HSI PS
ILKAR7J7G	RWN 42 HSI PS
ILKR9G8	RZC 82 HSDPS
ILZFR 6 D-11	RFC 58 HZEDP 5

**EYQUEM**

NGK	
ITR6F13	RN 62 LJZEDP 6
IZFR 5 B	RFC 42 LZDP
IZFR6H11	RFN 58 LZDPE5
IZFR6P7	FN 68 LZIFRS
L 66 Y	705 S
L 82 YC	705 S
L 82 YCC	705 S
LFR 4 AP-11	RFN 42 HZP 5
LFR 5 A-11	RFN 52 HZ 5
LFR 5 B	RFN 52 HZ
LFR 6 A-11	RFN 58 HZ 5
LFR 6 A-11	RFN 58 HZ 3A
LFR 6 B	RFN 58 HZ
LFR 6 B	RFN 58 HZ 3A
LFR 6 C-11	RFN 58 HZ 5
LFR 5 AP-11	RFN 42 HZP 5
LKR 6 D10-E	RZC 58 HST
LKR 8 A	RZC 68 HS2
LZKAR6 AP-11	RWC 58 HSE5DP
LZKAR 7 A	RWC 52 HSK
LZKAR 7 B	RWC 58 HSEW
LZKAR7D-9D	RWC 58 HSEW
LZKR 6 AI-10G	RZN 32 HSWDP
LZKR 6 B-10E	RZC 62 HSET
N 89 Y	750 LS
N 9 Y	750 LS
N 9 YC	750 LS
OE 038	705 S
OE 068	750 LS
PFR 5 G-11	RFN 58 LZDP 5
PFR 5 J-11	RFN 58 LZDP 5
PFR 5 R-11	FN 42 LZDPR 5
PFR 6 B	FN 58 LZDPR
PFR 6 E-10	RFC 62 LSDP 5
PRF 6 G	RFN 62 LZDP 5
PFR 6 G-9	RFN 58 LZDP
PFR 6 G-11	RFN 62 LZDP 5
PFR 6 Q	FN 58 LZDPR
PFR 7 H-10	RFN 62 LZDP 5
PFR7S8EG	FN 68 LZDPR
PLFER7A8EG	FN 72 HZIPRSO
PLFR 5 A-11	RFN 42 HZDP 5
PLZKAR6A-11	RWC 58 HSE5DP
PLKR7A	ZN 68 HSTDPR
PLKR7B8E	ZN 68 HSTDPR
PLZFR6A-11S	RFC 58 HZEDP 5
PLZKBR7A-G	RXC 58 HSEDP
PLZKBR7A-G	RXN 62 HSDP
PLZKBR7A-G	RXC 42 HSEDP 2A
PLZKBR7B8DG	RXN 62 HSDP
PMR 7 A	RTC 62 LSDP
PTR 5 A-13	RC 62 HJSP
PTR 5 D-10	RC 52 LJS 5
PTR6 D-13	RN 62 LJZDP 6
PTR 6 D-13G	RN 62 LJZDP 6
PTR 6 F-13	RN 62 LJZDP 6
PZFR 5 N-11 G	FN 62 LZFDPR 2A
PZFR 5 N-11 T	FN 62 LZFDPR 2A
PZFR 5D-11	RFN 52 LZDPF 5
PZFR6J-11	RFN 52 LZDPF 5
PZFR6R	FC 62 LSDPR
PZKER7A8EGS	ZN 62 LSDPFRSO
QL 77J C4	850
SILZKBR8D8S	RXN 72 HSDPFT
SILZKGR8B8S	RXN 72 HSI PFSO

**EYQUEM**

NGK	
SIZFR6B8EG	FN 72 LZIFRS
TR 55	RC 22 LJZ 7
TR 5 B-13	RC 62 HJS 6
TR 6 AP-13	RN 62 LJZEDP 6
TR 6 AP-13E	RN 62 LJZEDP 6
UL 4 J	850
UL 81 C	850
UL 81 J	1000
UL 81 J	850
UN 8 Y	755 LS
UR 5	RC 42 JS
V-Line Nr. 1	RC 58 LZ 3EX
V-Line Nr. 10	RC 62 LS 5
V-Line Nr. 11	RFC 52 LS 5
V-Line Nr. 12	RFC 52 LS
V-Line Nr. 13	RC 62 LS 5
V-Line Nr. 14	RFC 52 LS 5
V-Line Nr. 15	RC 52 LZ
V-Line Nr. 16	FC 42 LS
V-Line Nr. 17	FC 52 LS
V-Line Nr. 18	600 S
V-Line Nr. 18	C 42 S
V-Line Nr. 19	RC 72 LS
V-Line Nr. 2	RC 62 LS
V-Line Nr. 20	RFC 58 LZ 2E
V-Line Nr. 21	RC 52 LZ 3EX
V-Line Nr. 22	RC 52 LZ 3EX
V-Line Nr. 23	RFC 42 LZ 2E
V-Line Nr. 24	RFC 58 LZ 3EX
V-Line Nr. 25	RC 62 HJSP
V-Line Nr. 26	RFC 58 LZ 2E
V-Line Nr. 27	RFC 58 LZ 3EX
V-Line Nr. 28	RFC 52 LS
V-Line Nr. 3	RC 42 S
V-Line Nr. 30	RFC 58 LZP 4
V-Line Nr. 31	RC 52 LJS 5
V-Line Nr. 32	RFC 42 LS
V-Line Nr. 33	RFC 42 LS 5
V-Line Nr. 34	RFN 52 LZDPF 5
V-Line Nr. 35	RFC 42 LS
V-Line Nr. 36	RFC 42 LS
V-Line Nr. 38	RFN 58 LZ
V-Line Nr. 38	RFN 58 LZ 3A
V-Line Nr. 4	707 LS
V-Line Nr. 4	750 LS
V-Line Nr. 4	C 62 LS
V-Line Nr. 5	C 62 LJS
V-Line Nr. 6	RC 52 LS
V-Line Nr. 7	RC 52 LJS
V-Line Nr. 8	600 LS
V-Line Nr. 8	C 52 LS
V-Line Nr. 9	RC 52 LS
ZFR 5 E-11	RFC 58 LZ 5
ZFR 5 F	RFC 52 LZ
ZFR 5 F-11	RFC 58 LZ 5
ZFR 5 P-G	FN 58 LZKFR
ZFR 6 A-11	RFC 58 LZ 5
ZFR 6 F-11	RFC 58 LZ 5
ZFR 6 J-11	RFC 58 LZ 5
ZFR 6S-Q	RFC 62 LS4GF 6
ZFR 6T-11G	FN 58 LZKFR 5
ZFR6V-G	RFN 42 LZG
ZGR 5 A	RC 52 LZ
ZKR 7A-10	RZC 58 LS
ZKR 7A-10	RZC 62 LSE

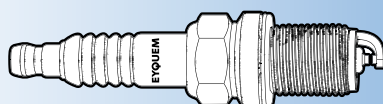

**EYQUEM****NISSAN**

22401-2F200	RFC 58 LZ F 5
22401-5M015	RFN 42 HZDP 5
22401-8H315	RFN 42 HZP 5
22401-8H515	RFN 52 HZ 5
22401-8H575	RFN 52 HZ 5
22401-8H575-Q0	RFN 52 HZ 5
22401-AX015	RFN 42 HZP 5
22401-BC01B	RFN 42 HZP 5
22401-BC05A	RFN 42 HZP 5
22401-CK81 B	RWC 58 HSE5DP
22401-ED815	RWC 58 HSE5DP
22401-1HC1 B	RWC 58 HSE5DP
22401-00Q0K	RWN 42 HSIP5
B2401-4A00A	RZC 62 LSDP 5K

OPEL

4408937	RFN 58 LZDP
4410220	RFN 58 LZDP
4413288	RFN 58 LZDP
4432200	RFN 58 LZDP
90 350 018	RC 62 LS
90 359 815	RC 52 LS
90 414 815	RFC 52 LZE
90 444 723	RFC 42 LZ 2E
91 160 172	RFN 58 LZDP
93 160 201	RFN 58 LZDP
93 161 199	RFN 58 LZDP
93 161 947	RFN 58 LZDP
93 190 948	RC 62 HJS 6
97 125 696	RFN 58 LZDP 5
12 14 000	RC 42 S
12 14 002	RC 52 LS
12 14 003	RFC 58 LZ 2E
12 14 004	RFC 52 LZE
12 14 005	RFC 42 LZ 2E
12 14 012	RC 42 HJS 3E5
12 14 013	RC 42 HJS 3E5
12 14 015	RFC 42 LZ 2E
12 14 016	C 42
12 14 019	C 62 S
12 14 020	C 42
12 14 021	C 62 S
12 14 023	C 62 S
12 14 024	C 52 LS
12 14 024	RC 52 LS
12 14 025	C 62 LS
12 14 031	RFN 42 LZG
12 14 038	C 62 S
12 14 039	C 62 LS
12 14 043	C 72 LS
12 14 044	C 42 S
12 14 046	C 42
12 14 108	RC 72 LS
12 14 110	C 72 LS
12 14 111	RC 42 S
12 14 112	RC 72 LS
12 14 118	RC 42 S
12 14 119	RC 72 LS
12 14 121	RC 42 S
12 14 122	RC 72 LS
12 14 131	RC 42 S
12 14 132	RC 72 LS
12 14 138	RC 42 S
12 14 139	RC 62 LS
12 14 144	RFN 58 LZ

**EYQUEM****OPEL**

12 14 144	RFN 58 LZ 3A
12 14 145	RFC 58 LZE 5
12 14 145	RFC 58 LZE 5
12 14 148	RFC 58 LS 5
12 14 149	RC 52 LS
12 14 193	RC 62 LS
12 14 455	RFC 42 LZ 2E
12 14 527	RFC 58 HZEDP 5
12 14 700	RC 42 S
12 14 701	RC 42 S
12 14 702	RC 72 LS
12 14 800	RC 42 S
12 14 801	RC 42 S
12 14 802	RC 72 LS
12 14 803	RC 62 LS 5
12 14 804	RFC 58 LS
12 14 805	RC 42 S
12 14 806	RC 72 LS
12 14 807	RC 62 LS
12 78 888 4	RFC 58 HZEDP 5
14 14 038	RC 62 S
32 017 024	RFN 58 LZDPE5
47 08 892	RZC 62 LSDP 5K
89 70 864	C 62 LS
91 99 038	RC 42 HJS 3E5
93 176 801	RFN 42 LZG

PAL

D 14 Y	FC 62 LS
D 14 YC	FC 62 LS
D 15 Y	FC 58 LS
D 15 YC	FC 58 LS
D 17 Y	FC 42 LS
D 17 YC	FC 42 LS
DR 12 YC	RFC 82 LS
DR 14 YC	RFC 62 LS
DR 14Z C-1	RFC 82 LS 5
DR 15 TC	RFN 42 LZP
DR 15 YC	RFC 58 LS
DR 15 Z	RFC 62 LS
DR 15 Z-1	RFC 62 LS 5
DR 17 YC	RFC 42 LS
DX 14 TC	RFC 62 LZ 3EX
DX 15 TC	RFC 58 LZ 3EX
F 14 YC	RKC 62 JS
FR 14 YC	RKC 62 JS
FR 15 YC	RKC 62 JS
G 12 YC	C 82 LJS
G 14 Y	C 72 LJS
G 14 YC	C 72 LJS
G 15 Y	C 62 LJS
G 15 YC	C 52 LJS
G 15 YC	RC 52 LJS
GR 14 YC	RC 72 LJS
L 12 Y	C 82 LS
L 12 YC	C 82 LS
L 14	C 82 L
L 14 C	C 82 L
L 14 Y	C 72 LS
L 14 YC	C 72 LS
L 15 Y	C 62 LS
L 15 YC	C 62 LS
L 17 Y	C 52 LS
L 17 YC	C 52 LS
L X 14 TC	C 72 LS 3X

**EYQUEM****PAL**

LR 12 YC	RC 82 LS
LR 14 YC	RC 72 LS
LR 15 YC	RC 62 LS
LR 15 Z	RC 62 LS
LR 15 Z-1	RC 62 LS 5
LR 17 YC	RC 52 LS
LX 15 TC	C 62 LS 3X
LX 17 TC	C 52 LS 3X
N 14	C 72
N 14 C	C 72
N 14 Y	C 62 S
N 14 YC	C 62 S
N 15	C 42
N 15 C	C 42
N 15 Y	C 42 S
N 15 YC	C 42 S
N 17	C 32
N 17 C	C 32
N 17 Y	C 32 S
N 17 YC	C 32 S
N 19	C 32
N 19 C	C 32
NR 14 YC	RC 62 S
NR 15 YC	RC 42 S
SUPER G 8 Y	C 72 LJS
SUPER N 7 Y	C 32 S
SUPER 14 L 7 Y	C 52 LS
SUPER 14-7	C 32
SUPER 14-7 Y	C 32 S
SUPER 14-8	C 42
SUPER 14-8 Y	C 42 S
SUPER 14-9	C 82
SUPER 14-9 R	RC 82
SUPER 14-9 Y	C 62 S
SUPER 14L5 Y	C 32 LS
SUPER 14L8 Y	C 72 LS
SUPER 14L9	C 72 L
SUPER 14L9 Y	C 82 LS
SUPER G 7 Y	C 52 LJS
SUPER L 5 Y	C 32 LS
SUPER L 7 Y	C 52 LS
SUPER L 8 Y	C 72 LS
SUPER L 9 Y	C 82 LS
SUPER N 7	C 32
SUPER N 8	C 62
SUPER N 8 Y	C 62 S
SUPER N 8 Y	RC 62 S

PEUGEOT

5960 15	RFN 58 LZ
5960 15	RFN 58 LZ 3A
5960 16	RFN 58 HZ
5960 16	RFN 58 HZ 3A
5960 17	RFN 52 HZ
5960 53	RFN 52 HZ 3A
5960 55	RWC 52 HSK
5960 56	RWC 52 HSK
5960 75	RFN 52 HZ 3A
5960 81	RFN 42 HZDP 5
5960 83	RWC 52 HSK
5960 92	RXC 58 HSEDP
5960 92	RXN 62 HSDP
5960 93	RXC 58 HSEDP
5960 97	RFN 58 HZ 5
5960 A5	RXC 62 HSEDP



**EYQUEM****PEUGEOT**

5960 C0	RFN 58 LZ 3A
5960 E1	RXC 58 HSEDP
5960 F0	RFN 58 LZ
5960 F1	RFC 58 LZ 2
5960 F2	RFN 52 HZ 3A
5960 F3	RFN 58 HZ
5960 F3	RFN 58 HZ 3A
5960 F7	RFN 52 HZ
5960 G1	RWC 52 HSK
5960 G3	RFN 52 HZ 3A
5960 G4	RXC 58 HSEDP
5960 H9	RXC 58 HSEDP
5960 J3	RFC 58 LZK
5960 J2	RFC 58 LZK
5960 J2	RFN 58 LZ
5960 J3	RFC 58 LZK
5960 J4	RC 62 LJS
5960 J8	RFC 58 LS 3
5960 J9	RFN 58 LZ 3A
5960 K1	RFC 62 LS
5960 K9	RXN 62 HSDP
5960 L0	RXC 58 HSEDP
5960 L2	RFN 58 HZ 5
5960 L3	RXC 42 HSEDP 2A
5960 L5	RXN 62 HSDP
5960 L7	RXC 42 HSEDP 2A
5960 O2	RXC 42 HZGP 5
5962 00	FC 42 LS
5962 1A	C 62 LS 3X
5962 1J	RFC 58 LZ 2E
5962 1N	RFC 42 LZ 2E
5962 2A	RC 62 LS
5962 2S	RFC 58 LZ 2
5962 3K	RC 32 LS
5962 3L	FN 52 LS
5962 3N	RC 42 S
5962 3Q	RC 52 LJS
5962 3R	RC 52 LS
5962 3V	RC 72 LS
5962 3W	RC 82 LS
5962 3Z	RC 62 LS
5962 4W	RFN 52 LZ
5962 5E	RFN 52 HZ
5962 5F	RFN 58 LZ
5962 5F	RFN 58 LZ 3A
5962 5R	RC 52 LS
5962 6K	RFC 58 LZK
5962 6V	RFC 58 LZK
5962 71	FC 52 LS
5962 72	C 62 LJS
5962 7X	RFN 58 HZ
5962 7X	RFN 58 HZ 3A
5962 87	C 72 LJS
5962 A5	RXC 58 HSEDP
5962 H1	C 82 LJS
5962 H2	FC 58 LS
5962 H8	RFC 42 LS
5962 H9	RFC 52 LS
5962 K0	RFC 58 LS
5962 L1	FC 52 LS
5962 L2	C 72 LJS
5962 L3	FC 42 LS
5962 L4	RFC 52 LS
5962 R5	RFC 58 LS 3
5962 S1	RC 72 LJS 3

**EYQUEM****PEUGEOT**

5962 W4	RFC 62 LS 3
5962 W6	RFC 62 LS
5962 Z9	C 32 S
596262 L0	FC 62 LS
96 73 806 380	RXC 42 HSEDP 2A
96 758 807 80	RXN 72 HSI PFS
96 762 881 80	RZN 32 HSWDP
98 028 401 80	RXC 42 HSEDP 2A
98 077 766 80	RXN 72 HSI PFS
V 753 422 680	RXC 58 HSEDP
V 753 422 680 03	RXC 58 HSEDP

RENAULT

22 40 100 32R	RWC 58 HSEW
22 40 115 26R	RWC 42 HSEW
22 40 115 61R	RWC 58 HSEW
22 40 120 47R	RWN 42 HSIPS
22401-2047R	RWN 42 HSIPS
22 40 187 60R	RWC 58 HSEW
22 40 191 33R	RWN 42 HSIPS
60 01 004 972	883 LJP
60 01 040 543	C 42 LJS 3
74 33 517 980	RFC 52 LS
74 39 146 775	RFC 52 LS 3
77 00 101 401	RFC 52 LS
77 00 103 502	RC 52 LS
77 00 103 503	RC 52 LS
77 00 109 403	RFC 58 LZ 2E
77 00 115 827	RFC 58 LZ 2E
77 00 266 295	RC 72 LJS
77 00 267 805	805 LJSP
77 00 273 462	RFC 42 LS
77 00 274 154	RFN 52 LZ
77 00 500 000	C 42 S
77 00 500 012	RC 32 LS
77 00 500 024	C 82 LS
77 00 500 036	805 LP
77 00 500 048	RC 52 LS
77 00 500 072	C 62 LJS
77 00 500 084	805 LJSP
77 00 500 108	C 82 LJS
77 00 500 120	RC 72 LS
77 00 500 132	RFC 58 LS 3
77 00 500 144	FC 62 LS 3
77 00 500 155	RFN 58 LZ
77 00 500 155	RFN 58 LZ 3A
77 00 500 168	RFC 58 LZ 2E
77 00 500 180	RFC 52 LS
77 00 500 204	C 42 LJS 3
77 00 500 228	883 LJP
77 00 553 622	C 52 LS
77 00 587 168	C 42 S
77 00 714 317	RC 52 LJS
77 00 714 540	RC 52 LJS
77 00 722 095	C 72 LJS
77 00 724 821	C 52 LS
77 00 725 302	RC 30 LS
77 00 726 503	C 82 LJS
77 00 727 383	RC 62 LS
77 00 731 583	C 82 LJS
77 00 732 626	C 82 LS
77 00 733 422	C 32 S
77 00 736 149	C 82 LJS
77 00 736 150	C 72 LJS
77 00 737 457	C 72 LJS

**EYQUEM****RENAULT**

77 00 737 458	805 LJSP
77 00 737 459	C 82 LS
77 00 737 612	FC 52 LS
77 00 742 094	RC 72 LS
77 00 743 137	FC 52 LS
77 00 743 920	C 52 LS
77 00 745 305	FC 62 LS
77 00 749 163	FC 42 LS
77 00 852 522	C 62 LJS
77 00 852 543	805 LJSP
77 00 855 463	FC 62 LS 3X
77 00 855 918	C 52 LJS
77 00 856 342	FC 62 LS 3
77 00 857 576	C 62 LS
77 00 859 967	C 32 LS
77 00 860 235	C 32 LS
77 00 861 471	C 72 LS
77 00 861 472	C 62 LS
77 00 862 054	C 52 LS
77 00 868 864	RC 72 LS
77 00 869 200	FN 52 LS
77 00 871 617	RFC 58 LS 3
77 01 021 767	C 62 LJS
77 01 023 082	C 52 LS
77 01 032 921	C 82 LJS
77 01 041 214	C 52 LS
77 01 041 215	C 62 LJS
77 01 043 624	RFC 58 LS 3
77 01 045 018	C 72 LJS
77 01 065 085	RWC 58 HSE5DP
77 01 366 057	C 42 S
77 01 366 084	805 LP
77 01 366 085	805 LP
77 01 366 086	C 62 LS
77 01 366 087	C 82 LS
77 01 366 137	C 62 LJS
77 01 366 138	C 82 LS
77 01 366 267	C 42 S
77 01 366 268	C 72 LS
77 01 366 269	C 62 LJS
77 01 366 270	C 52 LJS
77 01 366 513	C 32 S
77 01 366 514	C 62 LJS
77 01 366 515	C 42 S
77 01 366 516	C 62 LS
77 01 366 533	C 32
77 01 366 539	C 30 LS
77 01 366 903	C 32 LS
77 01 392 263	C 62
77 01 414 021	C 42 S
77 01 414 022	C 32 S
77 01 414 023	C 62 LS
77 01 414 024	C 82 LS
77 01 414 025	C 52 LS
77 01 414 026	C 82 LJS
77 01 414 027	C 72 LJS
77 01 414 028	C 72 LJS
77 01 414 029	C 82 LJS
77 01 414 030	RC 52 LJS
77 01 414 031	RC 62 LS
77 01 414 032	RC 30 LS
77 01 414 036	C 62 S
77 01 414 037	C 62
77 01 414 038	C 62 LJS
77 01 414 039	FC 52 LS

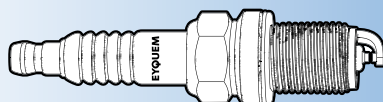

**EYQUEM****RENAULT**

77 01 414 040	RFC 58 LS
77 01 414 056	C 52 LJS
77 01 414 105	C 32 LS
77 01 414 111	RFC 52 LS
77 01 414 118	FC 58 LS
77 01 414 119	C 72 LS 3X
77 01 414 138	C 52 LJS
77 01 414 140	C 62 LS 3X
77 01 414 141	FC 62 LS
77 01 414 142	RC 62 LS
77 01 414 143	RC 72 LS
77 01 414 144	C 42 S
77 01 414 145	RFC 42 LS
77 01 417 651	C 62 LJS
77 01 417 653	C 82 LJS
77 01 417 654	C 82 LS
77 01 742 094	RC 72 LS
80 00 030 765	RWC 52 HSK
82 00 020 791	RFN 58 LZ
82 00 020 791	RFN 58 LZ 3A
82 00 020 796	RFN 58 LZ
82 00 020 796	RFN 58 LZ 3A
82 00 030 765	RWC 58 HSEW
82 00 046 337	RFN 58 LZDP
82 00 070 764	RFC 58 LZDP
82 00 070 764	RFC 58 LZP
82 00 307 688	RFC 58 LZP
82 00 307 688	RFC 58 LZDP
82 00 363 384	RFN 58 LZDP
82 00 587 901	RWC 62 HSDPS
82 00 662 185	RWC 52 HSK
82 00 662 185	RWC 58 HSEW
89 33 003 862	RFC 52 LS
96 26 575 480	RFC 58 LZ 2
96 32 182 880	RFC 58 LZDP
96 32 182 880	RFC 58 LZP

ROVER

GSP 66527	RFN 58 LZDP 5
GSP 9652	RFN 58 LZDP 5
NPL 100190	RFN 58 LZDP 5

SAAB

918868	RFN 62 LZDP 5
9399866	RFN 62 LZDP 5

SEAT

03C 905 601 A	FN 72LZIPFRS
03C 905 601 B	FN 72LZIPFRS
03F 905 600 A	FN 68 LZIPFRS
04E 905 601	ZN 62 LSDPFRSO
04E 905 612	ZN 62 LSDPFRSO
04E 905 612 C	ZN 62 LSDPFRSO
06H 905 601 A	FN 68 LZDPR
06H 905 621	FN 68 LZDPR
06H 905 911	FN 68 LZDPR
06K 905 601 B	FN 72 HZIPRSO
06K 905 611 C	FN 72 HZIPRSO
101 905 603 B	FN 58 LZKFR
101 905 626	FC 62 LSDPR
101 905 631	FN 68 LZDPR
101 905 631 B	FN 68 LZDPR
101 905 631 H	FN 68 LZDPR

**EYQUEM****SKODA**

03C 905 601 A	FN 72LZIPFRS
03C 905 601 B	FN 72LZIPFRS
04E 905 601	ZN 62 LSDPFRSO
04E 905 612	ZN 62 LSDPFRSO
04E 905 612 C	ZN 62 LSDPFRSO
06H 905 601 A	FN 68 LZDPR
06H 905 621	FN 68 LZDPR
06H 905 911	FN 68 LZDPR
06K 905 601 B	FN 72 HZIPRSO
06K 905 611 C	FN 72 HZIPRSO
101 000 049 AC	RFN 42 LZP
101 000 060 AA	RFN 42 LZP
101 905 626	FC 62 LSDPR
101 905 631	FN 68 LZDPR
101 905 603 B	FN 58 LZKFR
101 905 631 B	FN 68 LZDPR
101 905 631 H	FN 68 LZDPR

SMART

135 150 01 18	RFC 58 HZEDP 5
A 135 150 01 18	RFC 58 HZEDP 5
Q0012468 V00100000	RZC 68 HS2
Q0012468V002000000	RZC 68 HS2
0 012 468 V001	RZC 68 HS2
0 012 468 V002	RZC 68 HS2
004 159 15 03	RZC 68 HS2
A 004 159 15 03	RZC 68 HS2
A 281 159 01 00	RWC 58 HSEW
281 159 01 00	RWC 58 HSEW

SUZUKI

09482-00314	RTC 72
9482369	RZC 58 LS
09482-00527	RZC 58 LS
09482-00602	RZC 62 LSDP 5K
09482-00602-A00	RZC 62 LSDP 5K
09482-00603	RZC 62 LSDP 5K
09482-00603-000	RZC 62 LSDP 5K
09482M00611	RZC 62 LSDP 5K
90482-00448	RZC 58 LS
99000-79A37-U2F	RTC 72
99000-79K24-F22	RTC 72

SUBARU

22401 AA 310	RFC 52 LZDP
22401 AA 501	RFC 52 LZDP 5

TOYOTA

90919-01127	RFC 52 LZDP 5
90919-01128	RFC 52 LZDP
90919-01155	RFN 42 LZG 5
90919-01166	RFC 58 LZ
90919-01176	RFC 58 LZ
90919-01180	RFC 52 LZDP
90919-01182	RFC 52 LZDP 6
90919-01184	RFC 58 LZ 5
90919-01191	RFC 58 HZEDP 5
90919-01253	RWN 42 HSIW

UNIPART

GSP 131	C 30 LS
GSP 141	C 32 LS
GSP 163	C 62 LS
GSP 171	C 72 LS
GSP 191	C 82 LS

**EYQUEM****UNIPART**

GSP 244	RC 32 LS
GSP 263	RC 62 LS
GSP 264	RC 62 LS
GSP 281	RC 72 LS
GSP 361	RC 52 LJS
GSP 381	C 72 LJS
GSP 4154	RKC 62 JS
GSP 4256	C 62 S
GSP 4266	C 32
GSP 4342	C 82 LS
GSP 4347	C 82 LS 3X
GSP 4352	C 72 LS
GSP 4356	RC 62 S
GSP 4357	C 72 LS 3X
GSP 4362	C 62 LS
GSP 4366	C 42 S
GSP 4367	C 62 LS 3X
GSP 4372	RC 32 LS
GSP 4376	C 32 S
GSP 4382	C 30 LS
GSP 4452	RC 72 LS
GSP 44523	RC 58 LZ 3EX
GSP 4456	RC 62 S
GSP 4462	RC 62 LS
GSP 44623	RC 52 LZ 3EX
GSP 4472	RC 32 LS
GSP 4482	RC 30 LS
GSP 4543	C 82 LJS
GSP 4547	RFC 62 LS 3X
GSP 4552	FC 58 LS
GSP 4553	C 72 LJS
GSP 4562	FC 52 LS
GSP 4563	C 52 LJS
GSP 461	RC 52 LJS
GSP 4642	RFC 82 LS
GSP 4652	RFC 58 LS
GSP 46522	RFC 58 LZ 2E
GSP 46523g	RFC 62 LZ 3EX
GSP 4657	RFC 58 LS 3
GSP 4662	RFC 52 LS
GSP 46622	RFC 42 LZ 2E
GSP 4663	RC 52 LJS
GSP 4854	RKC 62 JS
GSP 531	C 32 S
GSP 541	C 42 S
GSP 571	C 62 S
GSP 6154	RKC 62 JS
GSP 634	RFC 42 LS
GSP 6356	C 62 S
GSP 6362	RC 62 LS
GSP 6366	RC 42 S
GSP 6382	C 30 LS
GSP 6452	RC 72 LS
GSP 6462	RC 62 LS
GSP 6468	RC 62 LS 5
GSP 6472	RC 32 LS
GSP 6521	RFN 52 LZ
GSP 6553	RC 72 LJS
GSP 6562	RFC 52 LS
GSP 6563	RC 52 LJS
GSP 664	RFC 52 LS
GSP 665	FC 52 LS
GSP 6652	RFN 58 LZ
GSP 6652	RFN 58 LZ 3A
GSP 6658	RFC 58 LS 5

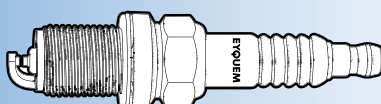

**EYQUEM****UNIPART**

GSP 6662	RFN 52 LZ
GSP 6663	RC 52 LJS
GSP 6668	RFC 52 LS 5
GSP 6682	RFC 42 LS
GSP 684	RFC 58 LS
GSP 685	FC 58 LS
GSP 6854	RKC 62 JS
GSP 6962	RFC 52 LZE
GSP 981	RKC 62 JS

VALEO

4 N	C 72
5 H	C 72 L
5 N	C 42 S
6 H	C 82 LS
64 H	C 82 LS
64 H3E	C 82 LS 3X
7 H	C 72 LS
70 H	C 72 LS
70 H3E	C 72 LS 3X
76 H	C 62 LS
76 H3E	C 62 LS 3X
8 H	C 52 LS
84 H	C 52 LS
84 H 3E	C 52 LS 3X
88 N	C 42 S
9 H	C 52 LS
90 H	C 32 LS
C 55 HP	883 LJP
C 60 H	C 82 LJS
C 62 HP	805 LJSP
C 64 H	C 72 LJS
C 64 HP	805 LJSP
C 67 HP	805 LP
C 68 H	C 62 LJS
C 7 H	C 72 LJS
C 72 H	C 52 LJS
C 8 H	C 62 LJS
F 72 H	FC 62 LS
F 72 H3	FC 62 LS 3
F 74 H	FC 58 LS
F 74 H3	RFC 58 LS 3
F 80 H	FC 52 LS
F 80 HDC	FN 52 LS
F 82 H	FC 42 LS
GC 68 N	RKC 62 JS
GC 72 N	RKC 62 JS
R 64 H	RC 82 LS
R 64 H11	RC 82 LS 5
R 70 H	RC 72 LS
R 74 HZ3YE	RC 58 LZ 3EX
R 76 H	RC 62 LS
R 76 H11	RC 62 LS 5
R 76 N	RC 62 S
R 84 H	RC 52 LS
R 84 H11	RC 52 LS 5
R 84 HZ3YE	RC 52 LZ 3EX
R 84 HZY	RC 52 LZE
R 88 N	RC 42 S
R 90 H	RC 32 LS
R 90 H11	RC 32 LS 5
R 92 H	RC 30 LS
RC 64 H	RC 72 LJS
RC 64 H3	RC 72 LJS 3
RC 68 H	RC 62 LJS

**EYQUEM****VALEO**

RC 72 H	RC 52 LJS
RC 72 H11	RC 52 LJS 5
RF 47 H11	RFC 58 LS 5
RF 64 H	RFC 82 LS
RF 64 H11	RFC 82 LS 5
RF 72 H	RFC 62 LS
RF 72 H/M112	RFC 62 LS
RF 72 H11	RFC 62 LS 5
RF 72 H3	RFC 62 LS 3
RF 72 H3E	RFC 62 LS 3X
RF 72 HZ3YE	RFC 62 LZ 3EX
RF 72 HZDC	RFN 62 LZ
RF 74 H	RFC 58 LS
RF 74 H3/M140	RFC 58 LS 3
RF 74 HZ	RFC 58 LZ
RF 74 HZ11	RFC 58 LZ 5
RF 74 HZ2	RFC 58 LZ 2
RF 74 HZ2Y	RFC 58 LZ 2E
RF 74 HZ3YE	RFC 58 LZ 3EX
RF 74 HZDC/M135	RFN 58 LZ
RF 74 HZDC/M135	RFN 58 LZ 3A
RF 74 HZY11	RFC 58 LZE 5
RF 74 LZDC/M139	RFN 58 HZ
RF 74 LZDC/M139	RFN 58 HZ 3A
RF 8 2H11	RFC 42 LS 5
RF 80 H	RFC 52 LS
RF 80 H11	RFC 52 LS 5
RF 80 H3	RFC 52 LS 3
RF 80 HZY	RFC 52 LZE
RF 80 LZDC/M138	RFN 52 HZ
RF 82 HZ2Y	RFC 42 LZ 2E
RF 82 HZDCS11	RFN 42 LZG 5
RF 90 HZ11	RFC 32 LZ 5
RGC 68 N	RKC 62 JS
RGC 72 N	RKC 62 JS
T 10	R 202 CT
T 6	R 755 CT
T 7	R 700 CTS
T 8	R 500 CT
TC 6	R 755 CJT
TC 8	R 500 CJT

VOLVO

30 731 425	RC 62 HJS 6
30 731 877	RC 62 HJS 6
30 735 760	RC 62 HJS 6

VW

57022	C 72 LS
101 905 600	RFN 52 LZDPF 5
101 905 601	RFN 52 LZDPF 5
101 905 617	FN 58 LZKFR
101 905 620	FN 62 LZFDPR 2A
101 905 626	FC 62 LSDPR
101 905 631	FN 68 LZDPR
191 905 450	C 72 LS 3X
191 905 452	C 82 LS
000 057 001	C 42
000 057 001 A	C 42
000 057 003	C 42
000 057 004	C 42
000 057 015	C 42
000 057 023 A	C 72 LS
000 057 066 A	C 52 LS 3X
000 057 067 A	C 62 LS 3X

**EYQUEM****VW**

03C 905 601 A	FN 72LZIPFRS
03C 905 601 B	FN 72LZIPFRS
03F 905 600 A	FN 68 LZIPFRS
04C 905 612 C	ZN 62 LSDPFRSO
04E 905 601	ZN 62 LSDPFRSO
04E 905 612	ZN 62 LSDPFRSO
04E 905 612 C	ZN 62 LSDPFRSO
06H 905 601 A	FN 68 LZDPR
06H 905 621	FN 68 LZDPR
06H 905 911	FN 68 LZDPR
0K6 905 601 B	FN 72 HZIPRISO
0K6 905 621	FN 72 HZIPRISO
06K 905 601 B	FN 72 HZIPRISO
06K 905 611 C	FN 72 HZIPRISO
101 000 000 AA	C 82 LS
101 000 000 AB	C 72 LS
101 000 001 AA	C 82 LS 3X
101 000 001 AB	C 72 LS 3X
101 000 001 AC	C 62 LS 3X
101 000 001 AD	C 52 LS 3X
101 000 001 AE	C 52 LS 3X
101 000 002 AA	C 52 LS
101 000 002 AB	C 62 LS
101 000 002 AC	C 72 LS
101 000 002 AD	C 82 LS
101 000 003 AA	FC 62 LS 3X
101 000 003 AB	FC 62 LS 3X
101 000 004 AA	FC 62 LS 3X
101 000 004 AB	RFC 62 LS 3X
101 000 005 AA	C 72 LS 3X
101 000 005 AB	C 62 LS 3X
101 000 005 AC	C 82 LS 3X
101 000 005 AD	C 52 LS 3X
101 000 005 AE	C 52 LS 3X
101 000 006 AA	C 82 LS
101 000 006 AB	C 72 LS
101 000 006 AC	C 62 LS
101 000 006 AD	C 52 LS
101 000 007 AA	C 82 LS 3X
101 000 007 AB	C 72 LS 3X
101 000 007 AD	C 52 LS 3X
101 000 015 AA	C 52 LJS
101 000 015 AB	C 72 LJS
101 000 018 AA	C 52 LS
101 000 019 AA	C 52 LS
101 000 020 AA	C 52 LS
101 000 025 AA	RFC 52 LZE
101 000 026 AB	RC 58 LZ 3EX
101 000 027 AA	C 72 LS 3X
101 000 027 AB	C 52 LS 3X
101 000 027 AC	C 52 LS 3X
101 000 031 AA	RFC 52 LS 3
101 000 033 AA	RFC 58 LZ 3EX
101 000 033 AB	RFC 62 LZ 3EX
101 000 033 AF	RFC 58 LZ 3EX
101 000 034 AA	C 62 LS
101 000 035 AB	RFC 52 LS 3
101 000 036 AA	RC 58 LZ 3EX
101 000 036 AB	RC 52 LZ 3EX
101 000 036 AC	RC 52 LZ 3EX
101 000 040 AC	RC 52 LZ 3EX
101 000 040 AD	RC 58 LZ 3EX
101 000 040 AE	RC 52 LZ 3EX
101 000 041 AC	RFC 58 LZ 3EX
101 000 041 AD	RFC 58 LZ 3EX

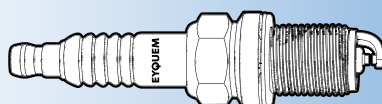

**EYQUEM****VW**

101 000 041 AE	RFC 62 LZ 3EX
101 000 050 AB	RC 52 LZ 3EX
101 000 050 AC	RC 58 LZ 3EX
101 000 051 AA	RFC 58 LZ 3EX
101 000 055 AA	RFC 58 LZ 2E
101 000 062 AB	RFN 52 LZDPF 5
101 000 063 AA	FN 58 LZDPR
101 000 065 AA	FN 58 LZDPR
101 000 068 AA	RFC 62 LS4GF 6
101 000 07 AC	C 52 LS 3X
101 905 600 A	RFN 52 LZDPF 5
101 905 600 C	RFN 52 LZDPF 5
101 905 601 B	FN 58 LZKFR
101 905 601 F	FN 58 LZKFR 5
101 905 603 B	FN 58 LZKFR
101 905 617 C	FN 58 LZKFR 5
101 905 631 B	FN 68 LZDPR
101 905 631 H	FN 68 LZDPR
191 905 450 A	C 62 LS 3X
191 905 450 B	C 52 LS 3X
191 905 450 C	C 82 LS 3X
191 905 450 G	FC 62 LS 3X
191 905 450 H	C 62 LS 3X
191 905 450 J	FC 62 LS 3X
191 905 450 K	C 52 LS 3X
191 905 450 L	C 82 LS
191 905 450 M	C 72 LS
191 905 450 N	C 62 LS
191 905 450 P	C 52 LS
191 905 451 J	RFC 62 LS 3X
191 905 452 A	C 72 LS
191 905 452 B	C 62 LS
191 905 452 C	C 52 LS
191 905 452 D	C 82 LS 3X
191 905 452 E	C 72 LS 3X
191 905 452 F	C 62 LS 3X
191 905 452 G	C 52 LS 3X
191 905 452 H	FC 62 LS 3X
N 017 801 1	C 42
N 017 801 11	C 42
N 017 801 13	C 42
N 017 801 2	C 42
N 017 801 7	C 42
N 017 801 8	C 42
N 017 802 1	C 42
N 017 802 13	C 42
N 017 803 9	C 42
N 017 811 12	C 72 LS
N 017 811 13	C 72 LS
N 017 811 14	C 72 LS
N 017 811 18	C 72 LS
N 017 811 20	C 72 LS
N 017 811 21	C 62 LS
N 017 811 22	C 72 LS
N 017 811 23	C 82 LS
N 017 811 25	C 82 LS
N 017 811 27	C 62 LS
N 017 811 28	C 62 LS
N 017 811 28	RC 62 LS
N 017 811 31	C 62 LS
N 017 811 32	C 82 LS
N 017 811 36	C 52 LS
N 017 811 39	C 62 LS
N 017 811 40	C 62 LS 3X
N 017 811 41	C 72 LS

**EYQUEM****VW**

N 017 811 47	C 52 LS
N 017 811 48	C 52 LS
N 017 811 49	C 82 LS
N 017 811 50	C 72 LS
N 017 811 51	C 62 LS
N 017 811 52	C 72 LS
N 017 811 53	C 52 LS
N 017 811 54	C 62 LS 3X
N 017 811 55	C 72 LS
N 017 811 56	C 52 LS 3X
N 017 811 57	C 72 LS 3X
N 017 811 58	C 52 LS 3X
N 017 811 59	C 82 LS
N 017 811 6	C 82 LS
N 017 811 60	C 72 LS 3X
N 017 811 61	C 72 LS 3X
N 017 811 63	C 32 LS
N 017 811 64	C 62 LS 3X
N 017 811 65	C 52 LS 3X
N 017 811 66	C 62 LS
N 017 811 67	C 82 LS 3X
N 017 811 68	C 62 LS 3X
N 017 811 69	C 82 LS 3X
N 017 811 72	C 62 LS 3X
N 017 811 73	C 72 LS 3X
N 017 811 74	C 72 LS 3X
N 017 811 76	C 82 LS
N 017 811 77	C 72 LS
N 017 811 78	C 62 LS
N 017 811 79	C 52 LS
N 017 812 12	C 72 LS
N 017 812 13	C 72 LS
N 017 812 18	C 82 LS
N 017 812 19	C 62 LS
N 017 812 20	C 72 LS
N 017 812 21	C 82 LS
N 017 812 23	C 72 LS
N 017 812 24	C 52 LS
N 017 812 27	C 62 LS
N 017 812 30	C 62 LS
N 017 812 34	C 52 LS
N 017 812 35	C 82 LS
N 017 812 36	C 62 LS
N 017 812 37	C 72 LS
N 017 812 39	C 82 LS
N 017 812 4	C 72 LS
N 017 812 40	C 72 LS
N 017 812 41	C 52 LS
N 017 812 44	C 82 LS
N 017 812 46	C 62 LS 3X
N 017 812 47	C 82 LS 3X
N 017 812 48	C 72 LS 3X
N 017 812 49	C 62 LS 3X
N 017 812 50	C 52 LS 3X
N 017 812 51	C 82 LS 3X
N 017 812 52	C 62 LS 3X
N 017 812 56	C 52 LS 3X
N 017 812 57	C 52 LS
N 017 812 58	C 62 LS
N 017 812 6	C 82 LS
N 017 812 60	C 82 LS
N 017 812 7	C 62 LS 3X
N 017 812 9	C 82 LS
N 017 813 10	C 72 LS
N 017 813 11	C 52 LS

**EYQUEM****VW**

N 017 813 12	C 72 LS
N 017 813 13	C 72 LS
N 017 813 16	C 82 LS
N 017 813 17	C 82 LS
N 017 813 18	C 72 LS
N 017 813 19	C 62 LS
N 017 813 20	C 62 LS
N 017 813 24	C 72 LS
N 017 813 26	C 62 LS
N 017 813 30	C 72 LS
N 017 813 32	C 82 LS
N 017 813 39	C 82 LS
N 017 813 40	C 62 LS
N 017 813 42	C 62 LS
N 017 813 43	C 82 LS
N 017 813 45	C 82 LS 3X
N 017 813 46	C 72 LS 3X
N 017 813 47	C 62 LS 3X
N 017 813 50	C 62 LS 3X
N 017 813 53	C 82 LS
N 017 813 54	C 72 LS
N 017 813 55	C 52 LS
N 017 813 6	C 72 LS
N 017 813 7	C 72 LS
N 017 813 8	C 82 LS
N 017 813 9	C 72 LS
N 017 821 1	C 62 LS
N 017 832 1	C 82 LS
N 017 832 2	C 82 LS
N 017 881 50	C 72 LS
N 100 807 01	FC 62 LS 3X
N 100 807 02	FC 62 LS 3X
N 101 172 01	FC 62 LS 3X
N 101 251 05	C 52 LJS
Z 057 003	C 42
Z 057 005	C 52 LS
Z 057 011	C 62 LS
Z 057 012	C 82 LS
Z 057 020	FC 62 LS 3X
Z 057 023	C 72 LS
Z 057 040	C 72 LS
Z 057 056	C 62 LS
Z 057 058	C 82 LS
Z 057 060	C 42
Z 057 062	C 72 LS
Z 057 064	C 42
Z 057 066	C 82 LS 3X
Z 057 067	C 72 LS 3X
Z 057 068	C 62 LS 3X
Z 057 069	C 52 LS 3X
Z 057 073	FC 62 LS 3X
Z 057 127	C 52 LS
Z 057 136	C 52 LS
Z 057 140	C 82 LS
Z 057 141	C 72 LS
Z 057 142	C 62 LS
Z 057 143	C 52 LS
Z 057 145	C 52 LJS

YAMAHA

94701-00250	RTC 72
94701-00254	RTC 72
94703-00366	RTC 72

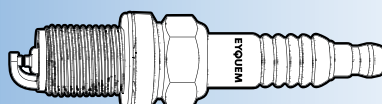

SUPPRESSIONS AND REPLACEMENTS SUPPRESSIONS ET REMPLACEMENTS

GELÖSCHT UND ERSETZT
CANCELADO Y REEMPLAZO



279

EYQUEM

Suppressions with replacement / Suppressions avec remplacement

Gelöschte Sachnummern mit Ersatz / Cancelado con posibilidad de reemplazo



202 CT	→	R 202 CT
502 CT	→	R 502 CT
C 72	→	RC 72
C 72 L	→	RC 72 L
C 72 LS	→	RC 72 LS
C 82	→	RC 82
C 82 L	→	RC 82 L
FC 52 LS 5	→	RFC 52 LS 5
FC 62 LS 3	→	RFC 62 LS 3
FC 62 LS 3X	→	RFC 62 LS 3X
FC 82 LS	→	RFC 82 LS
RC 62 HJSDP	→	RC 62 HJSP
RFC 50 LZ 2E	→	RFC 58 LZ 2E
RFC 57 LS 3	→	RFC 58 LS 3
RFC 58 LZDP	→	RFC 58 LZP
T 850	→	RTC 72



Suppressions without replacement / *Suppressions sans remplacement*

Gelöschte Sachnummern ohne Ersatz / Cancelado sin posibilidad de reemplazo

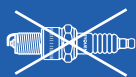

200

500 C

1000

R 700 CTS

R 755 CJT

RC 42 JS

RC 48 JS

RC 58 JS

RKC 62 JS



Spark plug diagnostic / Diagnostic bougies

Zündkerzendiagnose / Diagnóstico bujías

GB

SPARK PLUG FIRING AND ANALYSIS

The colour of the spark plug insulator nose clearly reflects the general conditions of the engine on which they are fitted as well as its state of tuning and its operating conditions. It is wise to periodically check the state of the spark plugs and to perform a visual inspection of the deposits on their firing ends; this will give valuable information regarding the general condition of the engine and the suitability of the spark plug being used in it.

F

DIAGNOSTIC BOUGIES

La couleur du bec de l'isolant de la bougie est significative de l'état du moteur sur lequel elle est montée, de son réglage, et de son utilisation. Il convient de vérifier périodiquement l'état de vos bougies, de procéder à l'examen visuel de leurs dépôts.

Ceci vous renseignera sur "l'état de santé" de votre moteur et sur l'adéquation de ses bougies.

D

ZÜNDKERZEN-DIAGNOSE

Die Farbe der Isolatorspitze gibt Aufschluß über den Zustand des Motors, in den sie eingebaut wurde, dessen Einstellung und Betriebsbedingungen.

Es wird empfohlen, die Zündkerzen regelmäßig zu kontrollieren und nach Ablagerungen zu sehen; das gibt Ihnen Aufschluß über den "Gesundheitszustand" Ihres Motors und die richtige Wahl der Zündkerzen.

ES

DIAGNÓSTICO DE BUJÍAS

El color de la punta del aislante de la estado del motor sobre el cual está montada, utilización.

Es conviene verificar periódicamente el examen visual de sus residuos; esto denotará motor y la adecuación de sus bujía.

ITA

DIAGNOSI DELLE CANDELE DI AVVIAMENTO:

Il colore della punta dell'isolante è significativo cui è montata la candela, del suo grado di utilizzo.

Conviene verificare periodicamente l'età delle all'esame dei loro depositi, indicativi del buon motore e dell'efficienza delle candele.

NL

DIAGNOSE BOUGIES:

Bekijk de kleur van de keramische isolatie aan ontstekingszijde van de bougie. Deze kleur geeft U aanduidingen over de staat, de afstelling en het gebruik van de motor waarin de bougie gemonteerd was.

Het volstaat om op geregelde tijdstippen de toestand van de bougies te controleren door gewoon de afzettingen op de Keramische isolatie en/of de electrodes te bekijken. Deze afzettingen geven U een beeld van de "gezondheidstoestand" van Uw en de efficiënte werking van de bougies.

SLO

Analiza in iskre vžigalne svečke

Barva spodnjega dela izolatorja pove v kakšnem stanju je motor, v katerem je svečka inštalirana. Prav tako pove tudi stanje delovanja in stanja navitja motorja. Priporočljivo je vsake toliko časa preveriti stanje vžigalnih svečk in narediti pregled spodnjega dela svečke, kjer daje iskre. To nam lahko da dragocene podatke o splošnem stanju motorja in primernost svečke, ki so bile uporabljene.

RO

Diagnoza bujiilor de aprindere

Producerea scanteii si analiza Culoarea izolatorului electrodului central reflecta foarte clar conditiile de functionare ale motorului precum si conditiile de operare ale bujiei. Se recomanda verificarea periodica a bujiei precum si o inspectie vizuala a depunerilor de pe suprafetele de lucru

Vom obtine informatii valoroase despre starea generala a motorului precum si despre gradul de potrivire al bujiei utilizate

P

DIAGNÓSTICO VELAS:

A cor da ponta do isolante da vela de ignição dá indicação do estado do motor, no qual está montada, da sua regulação e da sua utilização.

Convém verificar periodicamente o estado das vossas velas de ignição, proceder a un exame visual dos seus resíduos, isto informar-vos-à sobre "o estado de saúde" do vosso motor e se velas são as adequadas.

PL

DIAGNOSTYKA ĀWIEC:

Kolor końcówki izolatora świecy świadczy o stanie silnika, w którym jest ona zamontowana, o prawidłowej regulacji i sposobie użytkowania pojazdu.

Zaleca się okresową weryfikację stanu waszych świec, wizualne sprawdzenie ich powłoki. Taka czynność poinformuje o "stanie zdrowia" waszego silnika i prawidłowym doborze użytych świec.

GR

ΟΠΤΙΚΗ ΔΙΑΓΝΩΣΗ ΜΠΥΖΙ:

to χρώμα του άκρου του μονωτήρα του μλ ουζί είναι ενδεικτικό της κατάστα κινήτηρα (στον ολ οίο το μλ ουζί έχει tol o ετηθβι), τηζ ρύ μισήζ του και λειτουργίαζ του. Σαζ συνίστουμε ένα l εριοδικ έλεγχο της κατάστασηζ των μλ ουζί σαζ, οl τικό έλεγχο. Ετσι θα καταλά αν o κινήτηραζ λειτουργεί σωστά k i αν έχει tol θεt θεi σε αυτόν, o σωστόζ túl οζ μλ ουζί.

CZ

DIAGNOSTIKA ZAPALOVACICH SVIČEK:

Podle barvy špičky izolátoru lze posuzovat stav motoru, ve kterém byla svíčka namontována, jeho nastavení a provozní podmínky. Je doporučeno zapalovací svíčky pravidelně kontrolovat a posuzovat usazeniny. Ze stavu svíček lze usuzovat o celkovém stavu motoru a o správné volbě svíčky.

H

GYÚJTÓGYERTYA DIAGNOSZTIKA:

a gyújtógyertya szigetelő csúcsának színe általános állapotát, valamint a beállítás állapotát feltételeket. Ajánlott rendszeresen ellenőrizni állapotát és szemrevételezni a szigetelő csúcson képződött lerakódásokat. Ez értékelhető motor általános állapotára, valamint a megfelelő gyújtógyertyahasználatra vonatkozóan.

TR

ATEŞLEME BUJISINI ATEŞLEME UCU ANALIZLERI:

Ateşleme bujisinin izolatörünün (beyaz porselen kısım) ucunun rengi, kullanılmakta olduđu motorun çalışma şartlarının, motorun genel durumunun ve ayarların doğru olup olmadı ının açık bir göstergesidir. Bujinin durumunu periyodik olarak kontrol etmek ve ateşleme ucundaki birikintilerin durumunu gözle kontrol etmek çok faydalıdır. Bu şekilde hem motorun genel durumu ile ilgili faydalı bilgiler hemde kullanılan bujinin kullanıldığı motora uygun olup olmadığı anlaşılır.

HR

Dijagnostika svjećica:

Boja vrha izolatora svjećice jasno pokazuje opće stanje motora na koji su montirane isto kao i podešenost i radne uvjete motora.

Priporučljivo je povremeno provjeriti stanje svjećice i vrstu naslaga na vrhovima, ova provjera daje vrijedne informacije o općem stanju motora i primjenljivosti tipa svjećice.

BG

ИСКРЕНЕ НА СВЕЩИТЕ И АНАЛИЗ

ИСКРЕНЕ НА СВЕЩИТЕ И АНАЛИЗ

Цветът на върха на izolatora на свещта ясно отразява общото състояние на двигателя, на който те са поставени, също както и състоянието на регулировките и условията на експлоатация. Разумно е периодически да се проверява състоянието на свещите и да се прави визуална инспекция на нагара в искрящия край; това ще даде ценна информация относно общото състояние на двигателя и годността на свещта, използвана в него.



NORMAL WORKING CONDITIONS

Colour of insulator nose ranges from whitish / grey brown, to brown (more accentuated in LPG engines).

Results: Good cold start performance. Optimum engine efficiency, minimum petrol consumption, lowest pollution levels, protection of the catalyst device.

BON ETAT DE FONCTIONNEMENT

Bec d'isolant variant du blanc cassé ou brun (plus accentué pour les adaptés au véhicules excellents GPL). Bon état de fonctionnement, indice thermique adopté ou moteur, pas de résidus

Effets: Bons démarrages à froid. Rendement du moteur optimum, consommation minimale, échappement faiblement polluant, protection du catalyseur

CARBON FOULING

Firing ends of the spark plug covered with sooty deposits.

Probable causes: Over rich air/fuel mixture. Clogged air filter element. Wrong setting or extensive use of the choke device. Intensive urban use (thus not allowing self cleaning by pyrogenation). Spark plug incorrectly matched to engine and operating conditions.

Results: Poor cold start performances (even impossible to start). Misfire, possibility of damage to the catalyst device. Block polluting fumes from exhaust.

Solutions: Fit new set of spark plugs matching the engine requirements (always refer to the recommendation chart). Correctly set the carburettor timing. Check the air filter element and replace if necessary. Reset choke device and avoid extended use of manual choke.



DEPOTS DE SUIE CARBONEE

Partie active de la bougie recouverte d'une suie noirâtre.

Causes probables : Mélange trop riche. Filtre à air encrassé. Mauvais réglage ou usage abusif du starter. Circulation urbaine intensive (ne permet pas l'autonettoyage par pyrogenation). Bougies trop froides, non adaptées à l'utilisation du véhicule.

Effets: Démarrages à froid difficiles, voire impossibles. Ratés d'allumage, risque de détérioration du pot catalytique. Fumées noires et polluantes à l'échappement.

Remèdes: Monter un jeu de bougies adapté au moteur (respecter le guide de préconisations). Régler correctement le carburateur. Contrôler le filtre à air, le remplacer si nécessaire. Régler le starter automatique et éviter l'utilisation prolongée du starter manuel.

OIL / HYDROCARBON DEPOSITS

Firing ends of the spark plug covered with greasy / sooty deposits

Probable causes: Over abundance of oil in the combustion chamber (oil level too high), piston rings and cylinder sleeves worn and/or valve stem guides badly worn.

Results: Poor cold start performance (even impossible to start). Poor accelerating performance, misfire. Poor idle performance (engine instability). Bluish exhaust fumes and air pollution

Solutions: Complete overhaul of engine, retrofitting to standards as appropriate. Check oil level and change as appropriate. Fit new set of spark plugs.



DEPOTS HUILEUX HYDROCARBONES

Partie active de la bougie recouverte d'une suie grasse, d'aspect brillant.

Causes probables : Présence surabondante d'huile dans la chambre de combustion: niveau d'huile trop élevé, ou défaut d'étanchéité des segments et/ou cylindres et/ou guides de soupape anormalement usés. Effets : Démarrages à froid difficiles. Mauvaises reprises à l'accélération, ratés d'allumage. Ralenti instable. Fumées bleuâtres à l'échappement, pollution atmosphérique.

Remèdes : Révision complète du moteur, remise en état. Eventuellement, rétablir un niveau d'huile normal. Monter un jeu de bougies neuf.

INSULATOR GLAZING

Insulator is covered with glazed deposits, tan / yellow sometimes greenish.

Probable causes: The petrol used contains lead additives. This deposit occurs mainly after the spark plug has been fouled and the engine is then used under fast acceleration conditions.

Results: Misfire (the deposit becomes HV conductor under high temperature). The spark is no longer generated between the electrodes. Destruction of the catalyst exhaust device, air pollution.

Solutions: Fit new set of spark plugs. Always use manufacturers recommended fuel for engine.



VITRIFICATION

Le bec de l'isolant est recouvert de dépôts vitrifiés brun jaune, parfois vert.

Causes probables : le carburant contient des additifs à base de plomb. Ce dépôt se forme surtout quand le moteur est très sollicité, après encrassement de la bougie.

Effets : Ratés d'allumage car le dépôt devient conducteur à haute température. L'étincelle ne se manifeste plus entre les électrodes. Destruction du catalyseur, pollution atmosphérique.

Remèdes : Monter un jeu de bougies neuf. Préférer l'essence sans plomb, si le moteur le permet.

SPLIT OR BROKEN INSULATOR NOSE

Probable causes: Mechanical shock, mishandling of the Spark plug. Pinging due to incorrect ignition timing, or due the use of a too low fuel octane number (causing detonation).

Results: Misfire. Damage to the catalyst device. Possibility of serious engine damage by mechanical effect to internal ports in the combustion chamber.

Solutions: Fit new set of spark plugs. Reset ignition timing. Checking the accuracy of the fuel octane number.



ISOLANT CASSE OU FENDU

Causes probables: Choc mécanique, mauvaise manipulation de la bougie. Cliquetis dû à une avance à l'allumage excessive, ou à un indice d'octane trop bas (détonations).

Effets: Ratés d'allumage, destruction du pot catalytique. Risque de destruction par effet mécanique des organes de la chambre de combustion.

Remèdes: Monter un jeu de bougies neuf. Régler l'avance à l'allumage. Vérifier l'indice d'octane est adapté.

MELTING OF THE ELECTRODES

Melted ground and/or centre electrodes.

Probable causes: Preignition phenomenon caused by : wrong setting of the ignition timing, use of poor quality petrol, damaged or non pressure-tight valves, deposits in combustion chamber, spark plug) heat range not matching the engine requirements, leaking engine intake manifold.

Results: lack of spark. Inefficient ignition. Loss of power prior to engine damage.

Solutions: Complete checking of the ignition system. Use of good quality fuel. Fitting of a new set of spark plugs with correct heat range after overhaul of the engine.



FUSION DES ELECTRODES

Les électrodes centrales et/ou de masse sont fondues.

Causes probables: Phénomène de pré-allumage dû à : mauvais réglage de l'avance à l'allumage, mauvaise qualité du carburant utilisé, soupapes endommagées, non étanches, résidus dans la chambre de combustion, indice thermique des bougies non adopté au moteur, prise d'air additionnelle au conduit d'admission.

Effets: Absence d'étincelle, allumage inactif. Perte de puissance précédant une éventuelle détérioration du moteur.

Remèdes: Vérifier l'intégralité du circuit d'allumage. Utiliser un carburant de bonne qualité. Monter un jeu de bougies neuf, à indice thermique adapté, après remise en état du moteur.



GUTER ALLGEMEINZUSTAND

Die Isolatorspitze ist beige bis braun gefärbt (stärker ausgeprägt bei Fahrzeugen, die mit GPL betrieben werden). Guter Allgemeinzustand, der Wärmewert ist dem Motor angepaßt, keine Rückstände.

Auswirkungen: Guter Kaltstart, Höchstleistung des Motors bei geringem Verbrauch, Schädlichkeit der Auspuffgase ist unbedeutend, Schutz des Katalysators.

ABLAGERUNGEN VON KOHLESTOFFHALTIGEN RUß

Der aktive Teil der Zündkerze ist mit einem schwärzlichen Ruß bedeckt.

Mögliche Ursachen: Zu fettes Kraftstoff-Luftgemisch, Verschmutzter Luftfilter, Falsche Einstellung oder übermäßiger Gebrauch des Starters, Intensiver Stadtverkehr (erlaubt keine Selbstreinigung durch Pyrolyse), Falscher Wärmewert der Zündkernen (zu kalt), sind nicht dem Motor angepaßt.

Auswirkungen: Schwierigkeiten beim Kaltstart, teilweise nicht möglich. Fehlstart, eventuell Beschädigung des Katalysators. Dunkle und schädliche Auspuffgase.

Abhilfe: Setzen Sie einen neuen Satz Zündkerzen, die dem Motor angepaßt sind, ein (richten Sie sich nach den Empfehlungen im Katalog). Stellen Sie den Vergaser richtig ein. Kontrollieren Sie den Luftfilter und ersetzen Sie ihn, wenn nötig. Regeln Sie den automatischen Anlasser und vermeiden Sie eine längere Anwendung des Handstarters.

ÖLIGE ABLAGERUNGEN VON KOHLENWASSERSTOFF

Der aktive Teil der Zündkerzen ist mit einem fettigen glänzenden Ruß bedeckt.

Mögliche Ursachen: Übermäßiger Ölgehalt im Verbrennungsraum: zu hoher Ölspiegel, oder Undichtheit der Kolbenringe, und/oder der Zylinder, und/oder der Ventilführungen, die übermäßig abgenutzt sind.

Auswirkungen: Schwieriger Kaltstart, schlechte Beschleunigung, Fehlstarts unbeständiger Leerlauf, bläulicher Rauch im Auspuff, Luftverschmutzung.

Abhilfe: Komplette Überholung des Motors. Stellen Sie eventuell einen normalen Ölspiegel ein. Setzen Sie einen neuen Satz Zündkerzen ein.

SCHMELZERSCHWEINUNGEN

Die Zündkerzenspitze ist mit geschmolzenen gelb-braunen, teilweise grünen Ablagerungen bedeckt.

Mögliche Ursachen: Das Kraftstoffgemisch enthält bleihaltige Zusätze. Diese Ablagerungen bilden sich nach dem Verschmutzen der Zündkerze, besonders wenn der Motor sehr beansprucht wird. Auswirkungen: Fehlstarts, denn die Ablagerung wirkt als Stromleiter bei hoher Temperatur. Der Zündfunke bildet sich nicht zwischen den Elektroden. Zerstörung des Katalysators, Luftverschmutzung.

Abhilfe: Setzen Sie einen neuen Satz Zündkerzen ein. Benutzen Sie, wenn der Motor es erlaubt, bleifreien Kraftstoff.

ZERBROCHENER ODER GESPRUNGENER ISOLATOR

Mögliche Ursachen: Mechanischer Schock, unsachgemäße Handhabung der Zündkerze. Klopfende Verbrennung, hervorgerufen durch übermäßige. Frühzündungen oder durch einen Kraftstoff mit zu niedriger Oktanzahl.

Auswirkungen: Fehlzündungen. Zerstörung des Katalysators, Möglichkeit der Beschädigung von Teilen der Brennkammer durch mechanische Einwirkung.

Abhilfe: Setzen Sie einen neuen Satz Zündkerzen ein. Regeln Sie die Zündstellung. Kontrollieren Sie, ob die Oktanzahl dem Motor angepaßt ist.

VERSCHMELZUNG DER ELEKTRODEN

Die Mittelelektrode und/oder die Masselektroden zeigen Schmelzerscheinungen.

Mögliche Ursachen: Glühzündungen hervorgerufen durch: schlechte Einstellung der Zündstellung, schlechte Qualität des Kraftstoffes, beschädigte Ventile, die nicht mehr dicht sind, Ablagerungen in der Brennkammer, Wärmewert der Zündkerzen ist nicht dem Motor angepaßt, zusätzliche Luft im Einlassventil.

Auswirkungen: Kein Zündfunke, Fehlzündung. Reduzierte Leistung des Motors, die einer eventuellen Beschädigung des Motors vorausgehen kann.

Abhilfe: Kontrollieren Sie das gesamte Zündsystem. Benutzen Sie einen guten Kraftstoff. Setzen Sie einen neuen Satz von Zündkerzen mit richtigem Wärmewert nach der Instandsetzung des Motors ein.

BUEN ESTADO DE FUNCIONAMIENTO

Base del aislante variando del blanco marfil a marrón (mas acentuado en vehículos GPL). Buen estado de funcionamiento, índice térmico adaptado al motor, ausencia de residuos.

Efectos: Buen arranque en frío. Rendimiento óptimo del motor, mínimo consumo, escape poco contaminante, protección del catalizador.

DEPÓSITO DE CARBONO (HOLLÍN)

Parte activa de la bujía recubierta de un hollín negrozco.

Causas probables: Mezcla demasiado rica. Filtro de aire sucio. Mal reglaje o uso abusivo del starter. Circulación urbana intensa (no permitiendo la autolimpieza por pirogenación). Bujía demasiado fría, no adaptadas a la utilización del vehículo.

Efectos: Dificultad de arranque en frío, o imposible. Fallos de encendido, riesgo de deterioro del catalizador. Humo negro y contaminante en el escape.

Soluciones: Montar un juego de bujías adaptado al motor (respetar la guía de recomendaciones). Regular correctamente el carburador. Controlar el filtro de aire y sustituirlo si fuera preciso. Regular el starter automático y evitar la utilización prolongada del starter manual.

DEPÓSITO DE HIDROCARBUROS ACEITOSOS

Parte activa de la bujía recubierta de un hollín graso, de aspecto brillante.

Causas probables: Abundancia de aceite en la cámara de combustión: nivel de aceite demasiado alto, o defecto de estanqueidad de los segmentos y/o cilindros y/o guías de válvulas.

Efectos: Dificultad de arranque en frío. Mala aceleración, fallos de encendido. Ralentí inestable. Humo azulado en el escape, contaminación atmosférica.

Soluciones: Revisión completa del motor, puesta a punto. Nivel de aceite a su correcta medida. Montar un nuevo juego de bujías.

VITRIFICACIÓN

La punta del aislante está recubierta de depósitos vitrificados marrónamarillo, en ocasiones verdes.

Causas probables: El carburante contiene aditivos a base de plomo. Este depósito se forma cuando al motor se le somete a un sobreesfuerzo después de un engrase de las bujías.

Efectos: Fallos de encendido, ya que el depósito llega a ser conductor a altas temperaturas. Ausencia de chispa entre los electrodos. Destrucción del catalizador, contaminación atmosférica.

Soluciones: Montar un nuevo juego de bujías. Utilizar gasolina sin plomo, si el motor lo permite.

AISLANTE ROTO O RAJA DO

Causas probables: Choque mecánico, mala manipulación de la bujía. Picado de bielas debido a un excesivo avance de encendido, o a un índice de octano demasiado bajo (detonaciones)

Efectos: Fallos de encendido. Destrucción del catalizador. Riesgo de destrucción por efecto mecánico de los órganos de la cámara de combustión

Soluciones: Montar un juego de bujías nuevo. Regular el avance del encendido. Verificar que el índice de octano est el adecuado.

FUSIÓN DE LOS ELECTRODOS

Electrodos central y/o de masa están fundidos.

Causas probables: Fenómeno de autoencendido debido a: mal reglaje del avance del encendido, mala calidad del carburante utilizado, válvulas deterioradas, defecto de estanqueidad, residuos en la cámara de combustión, índice térmico de las bujías no adaptado al motor, toma de aire adicional en el colector de admisión.

Efectos: Ausencia de chispa, encendido inactivo. Pérdida de potencia precedente al deterioro del motor.

Soluciones: Verificar el funcionamiento del circuito de encendido. Utilizar carburante de buena calidad. Montar un juego de bujías nuevo, con un índice térmico adaptado antes de efectuar la puesta a punto del motor.

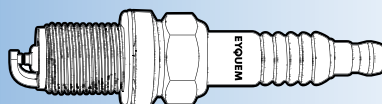



FUNZIONAMENTO EFFICIENTE DEL MOTORE

La punta dell'isolante varia di colore: dal Bianco al Bruno (più accentuato per i veicoli a Gas Liquido). Buon funzionamento, indice termico adatto al motore, assenza di residui.
Effetti: Buon avviamento a freddo. Rendimento ottimale del motore, consumo minimo, gas di scarico debolmente inquinanti, catalizzatore protetto.

GOEDE WERKING VAN MOTOR EN BOUGIES

De keramische isolatie heeft een kleur die varieert van gebroken wit tot bruin (iets bruiner voor motoren die op gas draaien). Er zijn geen afzettingen. Dit wijst op een goede werking en de thermische waarde van bougie is aangepast aan de motor.
Gevolgen: Goede koudstart eigenschappen. Optimaal rendement van de motor, minimaal verbruik, lage verontreiniging in de uitlaatgassen, goede bescherming van de katalysator

DEPOSITI CARBONIOSI

La punta attiva della candela è ricoperta da uno strato carbonioso.
Cause probabili: Carburazione troppo ricca. Filtro dell'aria antasato. Errata regolazione o abuso dello starter. Intensa circolazione urbana (non consente la pulizia per pirogenazione). Candele fredde, non adatte al veicolo.
Effetti: Avviamento a freddo molto difficile, quasi impossibile. Mancata accensione, rischio di deterioramento della marmitta catalitica. Gas di scarico inquinanti.
Rimedi: Montare candele adatte al motore (rispettare la referenza sulla guida di preconizzazione). Regolare correttamente il carburatore. Controllare il filtro dell'aria e sostituirlo se necessario. Regolare lo starter automatico ed evitare l'uso prolungato di quello manuale.



AFZETTING VAN KOOLSTOFPOEDER

De keramische isolatie en de electrodes zijn bedekt met een donkergrijze tot zwarte film van koolstof in poedervorm.
Waarschijnlijke oorzaak: Te rijke afstelling. Vuile luchtfilter. Slechte regeling of overdreven gebruik van de startmotor. Intensief stadsverkeer (korte afstanden en lage snelheden verhinderen de zelf-reinigende werking van de bougie). Te lage thermische waarde van de bougie. De bougie is niet aangepast aan het gebruik van de motor.
Gevolgen: Moeilijke koudstart, soms onmogelijk om te starten. Storing en onderbrekingen in de ontsteking. Gevaar voor verbranding van de katalysator. Zwarte rook en vervuiling van de uitlaatgassen.
Remedie: Monteer een stel bougies waarvan de thermische waarde hoger ligt. Respecteer hierbij de voorwaarde van de montagegids per type motor / automodel. Juiste afstelling van de carburateur of het injectiesysteem. Controleer de luchtfilter en vervang hem indien nodig. Juiste afstelling van de startautomaat en vermijd de langdurig manueel starten.

DEPOSITI OLEOSI DI IDROCARBURI

Punta attiva della candela ricoperta da una patina di grasso, di aspetti brillante.
Cause probabili: Presenza abbondante d'olio nella camera di combustione: livello dell'olio troppo alto, mancanza di impermeabilità dei segmenti o dei cilindri guida delle valvole usate.
Effetti: Avviamento difficile a freddo. Cattiva ripresa all'accelerazione, mancata accensione. Minimo instabile. Fumi di scarico bluastri inquinamento atmosferico.
Rimedi: Revisionare completamente il motore. Ristabilire il livello dell'olio. Montare candele nuove.



AFZETTING VAN OLIE EN VETTEN

De keramische isolatie en de electrodes zijn bedekt met een lichtjes glanzende en vette film.
Waarschijnlijke oorzaak: Te veel olie aanwezig in de verbrandingskamer: te hoog oliepeil en / of gebruik in de afdichting van de segmenten of cilinders en / of slijtage aan de geleiding van de kleppen.
Gevolgen: Moeilijke koudstart. Storing en onderbrekingen in de ontsteking, lange en trage versnelling van het voertuig. Onregelmatig lopen van de motor. Blauwe rook en hevige vervuiling van de uitlaatgassen.
Remedie: Revisie van de motor. Pas het oliepeil aan, vermijd overvulling. Monteer een nieuw stel bougies.

VETRIFICAZIONE

La punta dell'isolante è ricoperta da un deposito vitreo bruno-giallo, a volte verde.
Cause probabili: Il carburante contiene additivi a base di piombo. Il motore è molto sollecitato, le candele sono incrostate.
Effetti: Accensione difficile (il deposito vitreo diventa conduttore alle alte temperature). Mancanza di scintilla. Distruzione del catalizzatore, inquinamento atmosferico.
Rimedi: Cambiare le candele. Usare carburante senza piombo se il motore lo consente.

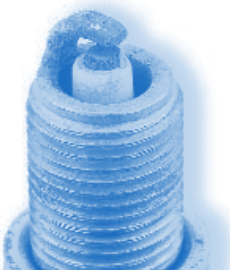

GLASACHTIGE AFZETTING

De ontstekingsmond van de bougie is bedekt met glasachtige schilfertjes van geel-bruine, soms zelfs groen.
Waarschijnlijke oorzaak: De brandstof bevat additieven op basis van lood. Dit soort van afzetting vormt zich bij hevig gebruik van de motor, nadat de bougies reeds vervuild waren.
Gevolgen: Storing en onderbreking in de ontsteking, want dit soort afzetting geeft geleiding bij hoge temperaturen: de vonk vertoont zich niet meer tussen de electrodes. Vernietiging van de katalysator, vervuiling van de uitlaatgassen.
Remedie: Monteer een nieuw stel bougies. Gebruik loodvrije brandstof indien de motor dit toelaat.

ISOLANTE DANNEGGIATO

Cause probabili: Urto meccanico, errata manipolazione della candela. Clicchetto dovuto a una preaccensione eccessiva, o a un carburante con un indice di ottani troppo basso.
Effetti: Mancata accensione. Distruzione della marmitta catalitica. Rischio di distruzione per effetto meccanico degli organi della camera di combustione.
Rimedi: Cambiare le candele. Regolare l'accensione. Verificare l'indice di ottani del carburante.



KERAMISCHE ISOLATIE GEBROKEN OF GEBARSTEN

Waarschijnlijke oorzaken: Mechanische schok, foutieve behandeling van de bougie. Onregelmatig draaien van de motor door ontijdige ontsteking, te vroege afstelling van de ontsteking, of een te laag octaangehalte.
Gevolgen: Storing en onderbrekingen in de ontsteking. Vernietiging van de katalysator, vervuiling van de uitlaatgassen. Gevaar voor schade aan het motorblok en de mechanische delen rond de verbrandingskamer.
Remedie: Monteer een nieuw stel bougies. Juiste afstelling van de ontsteking. Ga na of het octaangehalte van de brandstof aangepast is aan de afstelling van de motor.

SURRISCALDAMENTO DEGLI ELETTRODI

Gli elettrodi centrali o di massa sono fusi.
Cause probabili: Fenomeni di preriscaldamento, dovuti a: fenomeno di preaccensione, scarsa qualità del carburante utilizzato, valvole danneggiate, non impermeabili, residui nella camera di combustione, indice termico delle candele non adatto al motore, presa d'aria aggiunta al condotto di immissione.
Effetti: Assenza di scintilla, mancata accensione. Perdita di potenza con eventuale deterioramento del motore.
Rimedi: Verificare l'integrità del circuito d'accensione. utilizzare un carburante di buona qualità. Cambiare le candele. Rifare la messa a punto del motore.



VERSMELTING VAN DE ELECTRODES

De centrale electrodes en / of de massa zijn versmolten.
Waarschijnlijke oorzaken: Het fenomeen van de voorontsteking: te wijten aan de slechte afstelling van de ontsteking, slechte kwaliteit van de brandstof, beschadigde kleppen, afzetting in de verbrandingskamer, thermische waarde van de bougie niet aangepast aan de motor, ontoelaatbare aanzuiging van lucht in de toevoerleiding naar de motor.
Gevolgen: Onderbrekingen in de ontsteking: de bougie werkt niet meer. Verlies van vermogen, voorafgaand aan eventuele schade aan de motor.
Remedie: Controleer het volledige ontstekingscircuit. Gebruik goed brandstof. Na controle en eventuele revisie van uw motor, monteer een nieuw stel bougies, met passende thermische waarde.

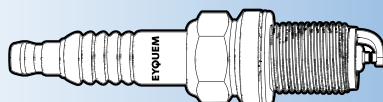

BOM ESTADO DE FUNCIONAMENTO

A ponta do isolante variando do branco-sujo ao castanho (mais acentuado nos veículos GPL). Bom estado de funcionamento, índice térmico adequado ao motor, sem resíduos. Efeitos: Bons arranques a frio. Bom rendimento do motor. Consumo mínimo. Gases de escape "limpos". Protecção do catalizador.

DEPÓSITOS DE FULIGEM DE CARVÃO

Se a parte activa da vela está coberta de uma fuligem preta.
Causas prováveis: Mistura demasiado rica. Filtro do ar sujo. Má regulação ou uso excessivo do "starter". Circulação urbana intensiva (não permite a auto limpeza por pirogenação). Velas demasiado frias, não adaptadas a utilização de veículo.
Efeitos: Arranques a frio difíceis, mesmo impossíveis. Falhas de auto ignição. Risco de deterioração da panela catalítica. Fumos negros e poluentes no escape.
Que fazer: Montar um jogo de velas adaptado ao motor (respeitar o guia de aplicações). Regular correctamente o carburador. Controlar o filtro de ar; substituí-lo se necessário. Regular o "starter" automático e evitar a utilização prolongada do "starter" manual.

DEPÓSITOS OLEOSOS HIDROCARBONADOS

Se a parte activa da vela está coberta de uma fuligem gordurosa, de aspecto brilhante.
Causas prováveis: Presença excessiva de óleo na câmara de combustão; nível do óleo demasiado elevado, ou defeito, por não garantir o estanque, dos segmentos e/ou cilindros e/ou guias das válvulas anormalmente usados.
Efeitos: Arranques a frio difíceis. Não tem potencia na aceleração, Falhas de auto ignição. Marcha lenta instável. Fumos azuis escuros no escape, poluição atmosférica.
Que fazer: Revisão completa do motor, reparação. Eventualmente, restabelecer o normal nível de óleo. Montar um jogo de velas novo.

VITRIFICAÇÃO

A ponta do isolante está coberta de resíduos vitrificados castanho-amarelos, por vezes verdes
Causas prováveis: O combustível tem aditivos a base de chumbo. Os resíduos acumulam-se sobretudo quando o motor é muito solicitado já com as velas sujas.
Efeitos: Falhas de auto ignição porque o excesso de resíduos fornecem um condutor a alta temperatura. Não se forma a faísca entre electrodos. Destruição do catalizador, poluição atmosférica.
Que fazer: Montar um jogo de velas novo. Usar gasolina sem chumbo se o motor o permitir.

ISOLANTE PARTIDO OU FENDIDO

Causas prováveis: Choque mecânico, má manipulação da vela de ignição. Grilos devidos a avanço de ignição excessivo, ou a um índice de octanas demasiado baixo (detonações).
Efeitos: Falhas de auto ignição. Destruição da panela catalítica. Risco de destruição por efeito mecânico dos orgãos da câmara de combustão.
Que fazer: Montar um jogo de velas novo. Regular o avanço. Verificar que índice de octanas é o indicado.

FUSÃO DOS ELECTRODOS

Electrodos centrais e/ou de massa fundiram.
Causas prováveis: Fenómeno de pre-ignição devido a: má regulação do avanço e ignição, má qualidade do combustível usado, válvulas danificadas, não estanques, resíduos na câmara de combustão, índice térmico das velas não adequado ao motor, tomada de ar a mais na admissão.
Efeitos: Ausência de faísca, ignição inativa. Perda de potência, indiciando uma eventual deterioração do motor.
Que fazer: Verificar a integralidade dos circuitos de ignição. Usar um combustível de boa qualidade. Montar um jogo de velas novo de índice térmico correcto, depois de reparar o motor

PRAWIDŁOWE FUNKCJONOWANIE

Kolor końcówki izolatora waha się od jasnego brązu do brązu (bardziej wyraźnie dla silników zasilanych gazem).

OSAD WĘGLOWY

Aktywna część świecy okryta czarnym osadem.
Możliwe przyczyny: Zanieczyszczony filtr. Zła regulacja zapłonu. Eksploatacja pojazdu głównie w cyklu miejskim. Złe dobrane świece do silnika.
Objawy: Utrudnione ruszanie przy zimnym silniku (nawet niemożliwe). Opóźniony zapłon. Wydalanie czarnych szkodliwych substancji zanieczyszczających.
Zalecenia: montaż kompletu świec odpowiednich dla silnika (zgodnie z katalogiem). Prawidłowa regulacja gaźnika. Kontrola filtra powietrza, jeżeli to konieczne wymiana.

OSAD OLEISTY WĘGLOWODOROWY

Aktywna część świecy pokryta tłustym białym osadem.
Możliwe przyczyny: nadmierna ilość oleju w komorze spalania (za wysoki poziom oleju). Częściowo zużyte pierścienie i gładź cylindrów. Znacznie zużyte prowadnice zaworowe.
Objawy: Utrudnione ruszanie przy zimnym silniku. Opóźniony zapłon. Wydalanie niebieskawych spalin.
Zalecenia: Kompletny przegląd silnika,

PRZYPALENIE

Końcówka izolatora pokryta nagarem brązowo-żółtym, czasem zielonym.
Możliwe przyczyny: Paliwo zawiera dodatki na bazie ołowiu
Objawy: Opóźniony zapłon. Brak iskry.
Zalecenia: montaż nowego kompletu świec. Stosowanie paliwa bezołowiowego jeżeli silnik na to pozwala.

PĘKNIĘCIE LUB ROZSZCZEPIENIE IZOLATORA

Możliwe przyczyny: Uszkodzenie mechaniczne, nieumiejętne obchodzenie się ze świecą. Stukanie silnika wskutek złego ustawienia zapłonu lub zastosowanie paliwa o zbyt niskiej liczbie oktanowej (detonacja).
Objawy: Opóźniony zapłon. Zniszczenie katalizatora. Ryzyko mechanicznego zniszczenia wewnętrznych części komory spalania.
Zalecenia: Montaż nowego kompletu świec. Ustawienie zapłonu. Zastosowanie paliwa o właściwej liczbie oktanowej.

STOPIENIE ELEKTROD

Elektrody centralna i/lub masowa są stopione.
Możliwe przyczyny: Przedwczesny zapłon spowodowany przez złe ustawienie zapłonu, złą jakość stosowanego paliwa, uszkodzone zawory, osady w komorze spalania, zastosowanie świec o niewłaściwej ciepłocie, kolektor zasysa obce powietrze.
Objawy: Brak iskry. Utrata mocy poprzedzająca uszkodzenie silnika.
Zalecenia: Sprawdzenie całości układu zapłonowego. Stosowanie paliwa dobrej jakości. Montaż nowego kompletu świec po uprzednim przeglądzie silnika.

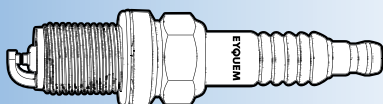



ΣΩΣΤΗ ΛΕΙΤΟΥΡΓΙΑ

Το άκρο του μονωτήρα έχει χρώμα μί εζ ή καφέ (1 ιο έντονο σε κινητήρες 1 ιου καίνε γκάζι) : Σωστή καύση, θερμική τιμή μί ουζί 1 ιου ανται οκρίνεται στο κινητήρα.
Καλή ξεκίνηση : Μέγιστη α1 δόση κινητήρα. Ελάχιστη κατανάλωση. Καυσαέριο χωρίς ρύλ ους. Προφύλαξη καταλύτη.

ΣΥΣΣΩΡΕΥΣΗ ΣΩΜΑΤΙΔΙΩΝ ΑΝΘΡΑΚΑ

Το άκρο του μονωτήρα και οι ακίδες έχουν καλυφθεί α1 fi ένα στρώμα μαύρης σκόνης.
Πιθανές αιτίες: 1 λούσιο μίγμα, βουλωμένο φίλτρο αέρα, κακή ρύθμιση κινητήρα, κλειστή 1 εταλούδα, συνεχής οδήγηση μέσα στη 1 όλη, θερμική τιμή μί ουζί 1 ιου δεν ανται οκρίνεται στο κινητήρα.
Ενδείξεις?: Δύσκολο ξεκίνημα με κρύο κινητήρα, ρετάριασμα, κίνδυνος ζημιάς στο καταλύτη, ρυλ ουγόνο καυσαέριο.
Ε1 ιλυση: Αντικαταστήστε το μί ουζί ώστε να ανται οκρίνονται στον κινητήρα (Σύμφωνα με τον κατάλογο). Ρυθμίστε το καρμλ υρατέρ.
Ελεγγάτε- Αντικαταστήσατε το φίλτρο αέρα.
Κλείστε το "τόκ" και α1 οφείγετε την μακρόχρονη χρήση τον.



ΛΑΛΩΜΕΝΕΣ ΑΚΙΔΕΣ ΚΑΙ ΣΥΣΣΩΡΕΥΣΗ ΣΩΜΑΤΙΔΙΩΝ ΑΝΘΡΑΚΑ

Το άκρο του μονωτήρα και οι ακίδες έχουν καλυφθεί α1 fi ένα γυαλιστερό στρώμα σωματιδίων άνθρακα.
Πιθανές αιτίες: 1 ερβολική 1 αρουσία λαδιού στο χώρο καύσης λόδω : 1 ερβολική 1 οσσητας λαδιού στο Κάρτερ, ελαττωματικών τσιμουχών, φθοράς βαλβίδων, φθοράς οδηδ βαλβίδων.
Ενδείξεις: Δύσκολο ξεκίνημα με κρύο κινητήρα, ρετάριασμα, δύσκολη ε1 ιτάχυνση, ασταθές ρελαντί, ρύλ ου μί λε α1 όχρωσης στα καυσαέρια.
Ε1 ιλυση: Πλήρης έλεγχος του κινητήρα, 1 ραγματο1 οίση ρθμίσεωv, α1 οκατάσταση ύψους λαδιού στο κάρτερ, το1 οθέτηση καινούργιων μί ουζί.



ΠΑΡΟΥΣΙΑ ΚΟΚΚΩΝ

1 αρή κόκκων στο άκρο του μονωτήρα χρώματος κίτρινου ή και 1 ράσιου.
Πιθανές αιτίες: Το καύσιμο 1 εριέχει μολβδόχα 1 ρόσιετα. Αυτή η συσώρευση δημιουργείται όταν ο κινητήρας 'ζοριστεί' μετά α1 ό μαύρισμα του μί ουζί.
Ενδείξεις: Ρετάριασμα του κινητήρα λόγω του ότι οι κόκκοι γίνονται καλοί αγωγοί ρεύματος στην υψηλή θερμοκρασία. Δεν 1 αράγεται σ1 ινθήρας μεταξύ των ηλεκτροδίων. Καταστροφή του καταλύτη.
Αύξηση της ατμοσφαιρικής ρύλ ανσης.
Ε1 ιλυση: Το1 οθέτηση καινούριων μί ουζί. Αν το ε1 ιτρέ1 ει ο κινητήρας χρησιμο1 οίησε βενζίνη χωρίς μίλιβδο.

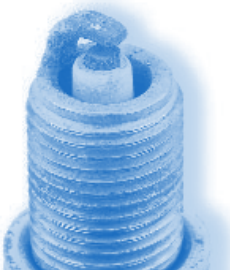

ΜΟΝΩΤΗΡΑΣ ΣΠΑΣΜΕΝΟΣ Η ΡΑΓΙΣΜΕΝΟΣ

Πιθανές αιτίες: Μηχανική βλάβη του κινητήρα. Χρήση 1 ερβολική αθάνι καυσίμου με 1 ολύ χαμηλά οκτάνια.
Ενδείξεις: Ρετάριασμα, καταστροφή του καταλύτη, 1 ιθανή βλάβη των κινητών μερών του θαλάμου καύσεως.
Ε1 ιλυση: Το1 οθέτηση καινούριων μί ουζί, ρύθμιση του 'αβάνς', έλεγχος οκτανίων βενζίνης.



ΛΙΩΜΕΝΑ ΗΛΕΚΤΡΟΔΙΑ

Το ηλεκτρόδιο σώματος και το κεντρικό ηλεκτρόδιο είναι λιωμένα.
Πιθανές αιτίες: Προανάφλεξη 1 ιου οφείλεται σε κακή ρύθμιση του 'αβάνς', κακή 1 οίφιτητα του καυσίμου, χαλασμένες βαλβίδες, ελαττωματικά έδρανα βαλβίδων, υ1 ολείμματα στο χώρο καύσης, θερμική τιμή μί ουζί 1 ιου δεν ανται οκρίνεται στο κινητήρα, εισαγωγή αέρα στη 1 ολλα1 λή εισαγωγής.
Ενδείξεις: Ελλειψη σ1 ινθήρα, ανενεργή ανάφλεξη, α1 ώλεια ισχύος με ε1 ακόλουθο τη βλάβη του κινητήρα.
Ε1 ιλυση: Πλήρης έλεγχος του κυκλώματος ανάφλεξης, αντικατάσταση καυσίμου με άλλο καλύτερης 1 οίφιτητας. Ρύθμιση του κινητήρα και το1 οθέτηση καινούριων μί ουζί των ο1 οίων η θερμική διαβάριση να ανται οκρίνεται στο κινητήρα.



NORMÁLNÍ PRACOVNÍ PODMÍNKY

Špička izolátoru je zabarvená do béžova až do hněda (obzvláště výrazné je to u motorů poháněných LPG). Dobrý všeobecný stav, správně zvolená tepelná hodnota, žádné usazeniny.
Účinek: Dobrá schopnost studených startů, optimální výkon motoru s nízkou spotřebou, zanedbatelná úroveň škodlivin, ochrana katalyzátoru.

KARBONOVÉ USAZENINY

Aktivní část svíčky je pokryta načernalými sazemi.
Možné příčiny: Příliš bohatá směs paliva se vzduchem, zanesený vzduchový filtr, špatné nastavení nebo nadměrné používání svíčky. Intenzivní městský provoz (nedojde k samočištění pyrolýzou). Špatná tepelná hodnota zapalovacích svíček (příliš studené), nevhodné pro daný typ motoru, nebo provozní podmínky.
Účinek: Těžkosti při studeném startu, někdy vůbec není možné nastartovat. Selhávání zapalování, případně poškození katalyzátoru. Tmavé a škodlivé výfukové plyny.
Řešení: Použijte novou sadu svíček, které jsou vhodné pro daný motor (říd'te se doporučením v katalogu). Správně nastavte karburátor. Zkontrolujte vzduchový filtr, popřípadě jej vyměňte, pokud je třeba. Nastavte automatický sytič a vyvarujte se delšího užívání ručního sytiče.

OLEJOVITÉ USAZENINY UHLOVODÍKU (SAZE)

Aktivní část svíčky je pokryta mastné lesklými sazemi.
Možné příčiny: Nadměrný obsah oleje ve spalovacím prostoru (příliš vysoká hladina oleje), nebo netěsnost pístních kroužků, nebo opotřebená vložka válců, nebo netěsná, příliš opotřebená vodítka ventilů.
Účinek: Těžkosti při studeném startu, špatné zrychlení, selhávání zapalování, nepravidelný volnoběh, namodralý kouř z výfuku, znečišťování ovzduší.
Řešení: Generální oprava motoru. Eventuálně udržujte hladinu oleje na stanovené úrovni. Použijte novou sadu svíček.

ZESKLOVATĚNÍ ISOLÁTORU

Izolátor je pokryt sklovitými usazeninami, hnědožlutě zbarvenými, částečně i do zelená.
Možné příčiny: Směs paliva obsahuje olovnaté příměsi. Tyto usazeniny se tvoří po znečištění zapalovací svíčky, obzvláště, pokud je motor příliš namáhán.
Účinek: Chybné zápaly, protože tyto usazeniny jsou při vysokých teplotách velmi vodivé. Zapalovací jiskra nepřeskakuje v prostoru mezi elektrodami. Poškodí katalyzátor a dochází k znečišťování ovzduší.
Řešení: Použijte novou sadu svíček. Pokud to motor dovolí, použijte bezolovnaté palivo.

NAŠTÍPNUTÝ NEBO ROZBITÝ ISOLÁTOR

Možné příčiny: Mechanický náraz, nepřiměřené zacházení se zapalovací svíčkou. Detonační spalování, vyvolané nadměrnými předčasnými zápaly nebo palivem s nízkým oktanovým číslem.
Účinek: Výpadky zapalování, zničení katalyzátoru, možnost poškození součástí ve spalovacím prostoru prostřednictvím mechanického působení.
Řešení: Použijte novou sadu svíček. Zkontrolujte nastavení zapalování. Zjistěte, zda používané palivo má vhodné oktanové číslo pro daný motor.

ROZTAVENÍ ELEKTROD

Středová nebo zemnicí elektroda vykazuje známky roztavení.
Možné příčiny: Zhnutí při zapalování vyvolané prostřednictvím: špatného nastavení zapalování, špatnou kvalitou paliva, poškozenými ventily, které už nemají správnou těsnost, usazeniny ve spalovacím prostoru, tepelnou hodnotou, která není přizpůsobena motoru, přisáváním vzduchu sacím ventilem.
Účinek: Žádná zapalovací jiskra, chybné zápaly. Pokles výkonu motoru, který může vyústit i v eventuelní poškození motoru.
Řešení: Zkontrolujte celý systém zapalování. Po opravě motoru použijte novou sadu zapalovacích svíček se správnou tepelnou hodnotou.

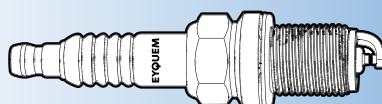

HELYES MŰKÖDÉSI FELTÉTELEK

A szigetelő csúcs színe a fehérestől a szürkés barnán át a barnáig terjed (leginkább gázüzemű motoroknál)

Eredmény: Jó hideg indítás, optimális motor teljesítmény, minimális üzemanyag felhasználás, alacsony környezetszennyezés, a katalizátor védelme.

ELKORMOZÓDÁS

A szigetelő csúcson és az elektródákon kormos lerakódás található.

Lehetséges okok: Dús levegő-üzemanyag keverék. Eltömődött levegőszűrő. A szivató rossz beállítása vagy túlzott használata. Gyakori városi használat (amely nem teszi lehetővé az öntisztulást). A gyújtógyertya nem a motornak és a működési feltételeknek megfelelő.

Eredmény: A motor hidegen nehezen indul (sikertelen indítás is előfordulhat). Gyújtáshiba, a katalizátor meghibásodását okozhatja. A kipufogó eltömődése.

Megoldás: Helyezzen be a motor követelményeinek megfelelő új gyújtógyertya szettet (mindig az útmutató táblázatnak megfelelő). Állítsa be a karburátort helyesen. Ellenőrizze a levegőszűrőt és szükség esetén cserélje ki. Állítsa be az automata szivatót és kerülje a kézi szivató hosszas használatát.

OLAJ/SZÉNHYDROGÉN LERAKÓDÁS:

A szigetelő csúcson és az elektródákon olajos, kormos lerakódás található.

Lehetséges okok: Túl sok olaj a robbanótérben (túl magas az olajsínt), a dugattyú gyűrű és a hengerfal elkopott és/vagy a szelepvezető kopott.

Eredmény: A motor hidegen nehezen indul (sikertelen indítás is előfordulhat). Kedvezőtlen gyorsulás, gyújtáshiba. Gyenge alaplátár (instabil motor). Kékes kipufogó gáz, környezetszennyezés.

Megoldás: A motor alapos átvizsgálása. Ellenőrizze az olajsínt és csökkentse a megfelelő szintre. Helyezzen be új gyújtógyertya szettet.

SZIGETELŐCSÚCSON ÉS AZ ELEKTRODÁKON KÉPZŐDÖTT BEVONAT

A szigetelő csúcsot sárgásbarna, sárgás, néha zöldes színű fényes felület borítja.

Lehetséges okok: Az üzemanyag ólom adalékot tartalmaz. Ilyen lerakódás főként elszennyeződött gyújtógyertyán jelenik meg, különösen erősen igénybe vett motor esetén.

Eredmény: Gyújtáshiba (a lerakódás magas hőmérsékleten magas feszültségű vezetővé alakul. A szikra többé nem az elektródák közt képződik). A katalizátor meghibásodik, légszennyezés.

Megoldás: Helyezzen be új gyújtógyertya szettet. Mindig a gyártók által ajánlott ólommentes üzemanyagot használjon a motorhoz.

TÖRÖTT, REPEDT SZIGETELÉS CSÚCS

Lehetséges okok: Mechanikus ütés, a gyújtógyertya helytelen használata. Kopogó hang a gyújtás miatt (túlzott előgyújtás, vagy utógyújtás esetén), vagy alacson üzemanyag oktánszám alkalmazás esetén (robbanást okoz).

Eredmény: Gyújtáshiba, katalizátor meghibásodása. Komoly motorhiba alakulhat ki mechanikai hatásra a robbanótér belső részeiben.

Megoldás: Helyezzen be új gyújtógyertya szettet. Állítsa be a gyújtást. Ellenőrizze az üzemanyag oktánszámot.

AZ ELEKTRODÁK OLVADÁSA

Megolvadt test- és/vagy központi elektróda. Lehetséges okok: Korai előgyújtás, melyek oka a gyújtás helytelen beállítása, gyenge minőségű üzemanyag használata, a szelepek meghibásodása, lerakódás a robbanótérben, a gyújtógyertya hőértéke nem felel meg a motor követelményeinek, szívárgás a szívózelepnél.

Eredmény: Nincs szikra, elégtelen gyújtás. A motor meghibásodásához vezet a gyenge teljesítmény.

Megoldás: A gyújtási rendszer átfogó vizsgálata. Jó minőségű üzemanyag használata.

A motor átvizsgálása után a motornak megfelelő hőértékű új gyújtógyertya szett behelyezése

DÜZGÜN ÇALIŞMA

İzolatorün uç kısmının rengi gri/beyaz dan kahverengine doğru değişim gösterir, kahverengileşme LPG kullanan motorlarda daha belirgindir.

Sonuç: Soğuk motorun kolay çalışması. Yakıt tasarrufu, hava kirliliğinin düşük seviyelerde tutulması, katalizatorün uzun ömürlü olması ve motorun beklenen en yüksek verimlilikte çalışması.

KARBON BİRİKİNTİSİ

Bujinin ateşleme ucu kurumla kaplanmıştır.

Tahmini sebepleri: Çok zengin yakıt/hava karışımı. Hava filtresinin tıkalı olması. Jigleinin çok kullanılması veya ayarının bozuk olması. Devamlı şehir içi kullanım (dolayısıyla birikintilerin yanarak kendi kendine temizliğin oluflmaması). Bujinin, kullanıldığı motor ve çalışma şartları için uygun olmaması.

Sonuç: Motor soğukken ilk çalışmanın çok zor olması (hatta bazen motorun hiç çalışmaması). Bujinin bazen ateşlememesi, katalitik konverterin zarar görmesi. Ekzoztan siyah dumanların çıkması.

Çözüm: Motora uygun yeni bujiler takın (herzaman kataloğun araçlara göre uygulamalar kısmına bakın). Karbüratör ayarını yapın. Hava filtresini kontrol edin gerekiyorsa değiştirin. Jikleiy yeniden ayarlayın ve el jiklesini uzun süre kullanmaktan kaçının.

YAĞ, HİDROKARBON BİRİKİNTİSİ

Bujinin ateşleme ucu yağlı is ve kurumla kaplanmıştır.

Tahmini sebepleri: Yanma odasında çok fazla yağ bulunması, yağ seviyesinin çok yüksek, segman ve silindir gömleklerinin aşınmış ve/veya supab aydalarının aşınmış olması.

Sonuç: Motor soğukken ilk çalışmanın çok zor olması (hatta bazen motorun hiç çalışmaması). Aracın kolay ivme kazanmaması ve bujinin bazen ateşlememesi. Düzensiz rölaneti. Ekzoztan mavi renkli duman çıkması ve hava kirliliği.

Çözüm: Motorun yenilenmesi ve standart ölçülü parçaların takılması. Yağ seviyesinin kontrol edilip gerekiyorsa yağ değişimi. Motora uygun yeni bujiler takılması.

İZOLATÖRÜN VİTRİFİYE OLMASI

İzolator sütü kahve/sarı bazen yeşil renkli vitrifiye olmuş (parlaklaşmış) birikintilerle kaplanmıştır.

Tahmini sebepleri: Kullanılan benzinde kurşunlu katkıların bulunması. Bu tip birikintiler genelde bujinin birikintilerle kaplanmasından sonra motorun yüksek devirde kullanılmasından sonra oluşur.

Sonuç: Birikintilerin yüksek sıcaklıkta yüksek voltaj iletkeni olması ateşleme problemi yaratır. Kıvılcım iki elektrod arasında oluşmaz. Katalitik konverter zarar görür, hava kirliliği oluşur.

Çözüm: Motora uygun yeni bujiler takın. Herzaman araç üreticisinin tavsiye ettiği yakıttan kullanın.

ÇATLAMIŞ VEYA KIRILMIŞ İZOLATÖR UCU

Tahmini sebepleri: Bujinin yanlış nakliyesi, dış darbeye maruz kalması. Avans ayarının bozukluğu yüzünden, veya düşük oktanlı yakıt kullanımından dolayı oluşan vuruntular ve patlamalar.

Sonuç: Ateşleme problemleri. Katalitik konverterin zarar görmesi. Yanma odasındaki supab yataklarının zarar görmesi ve ciddi motor arızaları.

Çözüm: Motora uygun yeni bujiler takın. Avans ayarını düzelttirin. Yakıt oktan seviyesini kontrol edin.

ELEKTRODLARIN ERİMESİ

Erimiş orta ve/veya yan elektrod (tırnak).

Tahmini sebepleri: Avans ayarının yanlış ayarı, düşük kaliteli yakıt kullanımı, sızdıran hasarlı supablar, yanma odası birikintileri, bujinin ısı değeri motoru uygun olmaması, sızdıran emme manifoldu gibi sebeplerden dolayı zamanından önce ateşleme (ön ateşleme).

Sonuç: Bujinin ateşlememesi. Verimsiz ateşleme. Motor gücünün kaybı ve uzun vadede motorun tamamen zarar görüp bozulması.

Çözüm: Ateşleme sisteminin tamamının kontrolü. İyi kaliteli yakıt kullanmak. Motor yenilendikten sonra ısı değeri motoru uygun yeni bujilerin takılması.

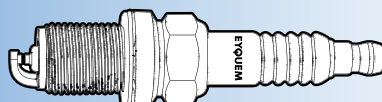



Normalni pogoji delovanja

Barva izolatorja je bela pa preko sivo rjave do rjave (bolj poudarjena v LPG motorjih)

Rezultat: dober mrzel zagon motorja, optimalni izkoristek motorja, najmanjša stopnja onesnaževanja, minimalna potrošnja motorja, zaščita katalizatorja.

NORMALNI RADNI UVJETI

Boja izolatora varira od bijelo/sivo/smeđe prema smeđoj (više istaknuto kod motora s plinskim uređajem)

Rezultati: Lagani hladni start. Optimalni uvjeti rada motora, mala potrošnja goriva, malo zagađenje i zaštita katalizatora.

Nastajanje ogljika saj

Konec, kjer potekajo iskre je prekrito z masnimi sajastimi usedlinami. Verjetni vzroki: preveč bogata mešanica goriva in zraka. Zamašen filter dotoka zraka. Intenzivna uporaba vozila v urbanih naseljih, kar ne omogoča samo čiščenja.. Svečka ni prava za motor oziroma ne dela v pravilnih pogojih.

Rezultat: slab mrzel zagon motorja. Možnost poškodbe katalizatorja. Rešitev: montaža novega pravega vžigalnih svečk, menjava zračnega filtra in ostalega zračnega sistema če je potrebno.



UGLJENE NASLAGE

Vrh svečice pokriven ugljenim naslagama.

Vjerojatni uzrok: Prebogata smjesa zrak/gorivo. Začepljen zračni filter. Pogrešno podešen ili upotrebljavan uređaj za hladni start. Intenzivna gradska vožnja (ne dolazi do efekta sagorijevanja naslaga). Pogrešan tip svečice za motor ili primjenu.

Rezultati: Otežan hladni start (ponekad i onemogućen). Pogrešno paljenje i mogućnost oštećenja katalizatora. Crni dim iz ispuha. Rješenje: Zamijeniti svečice odgovarajućim modelom (provjeriti u tabeli za primjenu). Podesiti rasplinjač. Provjeriti zračni filter i po potrebi zamijeniti. Podesiti i pravilno koristiti uređaj za hladni start.

Oljni in ogljikove vodikove usedline

Konec, kjer potekajo iskre je prekrito z masnimi sajastimi usedlinami. Verjetni vzroki: preveč olja v izgovalni komori. Obrabljeni batni obročki ali ventili.

Rezultat: slab zagon mrzlega motorja, nestabilnost motorja. Modrikast dim in onesnaževanje zraka.

Rešitev: Kompletan in natančen pregled motorja. Zamenjati variabilne komponente motorja, pregledati nivo olja in zamenjati vžigalne svečke.



ZAULJENE UGLJENE NASLAGE

Vrh svečice pokriven zauljenim ugljenim naslagama.

Vjerojatni uzrok: previsoka razina ulja u motoru, istrošeni klipni prstenovi i/ili vodilice ventila.

Rezultati: Otežan hladni start (ponekad i onemogućen). Loše ubrzanje. Pogrešno paljenje. Nemiran rad u praznom hodu. Plavkasti ispušni plinovi. Intenzivno zagađenje zraka.

Rješenje: Generalna reparatura motora. Provjera razine ulja. Zamijeniti svečice.

Zasteklitev izolatorja

Izolator je prekrit z steklenimi rumenimi, usedlinami, včasih zelenkaste. Verjetni vzroki: bencin vsebuje dodatke svinca. Te usedline se večinoma pojavijo, ko svečke že niso več dobre in ko se motor vrti v visokih vrtiljajih (pospeševanje).

Rezultat: grešenje isker, oz. iskre ne nastajajo med elektrodami. Uničenje katalizatorja in onesnaževanje zraka.

Rešitev: uporaba pravega bencina in zamenjava z novim setom vžigalnih svečk.



TALOŽENJE NA ISOLATORU

Izolator je prekriven sa talogom žuto/smeđe ili ponekad zelenkaste boje.

Vjerojatni uzrok: Gorivo sadrži olovne aditive. Do ovog taloženja uglavnom dolazi kod velikih opterećenja već nečistih svečica.

Rezultati: Pogrešno paljenje (talog postaje vodič pri visokim temperaturama i iskra se više ne stvara među elektrodama). Uništenje katalizatora i zagađenje zraka.

Rješenje: Zamijeniti svečice. Koristiti odgovarajuće gorivo za tip motora.

Zlomljen del izolatorja

Verjetni vzroki: mehanični tresljaji, nepravilno ravnanje z vžigalno svečko. Nepravilni časovni vžig ali pa uporaba bencina s premalo oktani.

Rezultat: Zgrešitev isker. Poškodba katalizatorja, možnost resne mehanične poškodbe motorja v izgovalni komori.

Rešitev: Uporabiti novi set vžigalnih svečk. Ponovno vzpostaviti oziroma resetirati vžig in preveriti primernost oktanov v gorivu.



NAPUKNUT ILI SLOMLJEN ISOLATOR

Vjerojatni uzrok: Mehanički udarac. Pogrešno rukovanje svečicom.

Detonantno izgaranje zbog loše podešenog pretpaljenja ili preniskog oktanskog broja goriva.

Rezultati: Pogrešno paljenje. Oštećenje katalizatora. Odlomljeni komad izolatora može uzrokovati teško oštećenje unutrašnjih dijelova motora.

Rješenje: Zamijeniti svečice. Podesiti pretpaljenje. Upotrijebiti gorivo odgovarajućeg oktanskog broja.

Topljenje elektrode

Stopljena spodnja ali centralna elektroda.

Verjetni vzroki: prežgaden vžig bencina, uporaba goriva slabe kakovosti, poškodovani ventili, usedline v izgovalni komori. Vročina ni prava za ta tip motorja.

Rezultat: pomanjkanje isker, neučinkovit vžig, pomanjkanje moči. Rešitev: celoten pregled vžigalnega sistema. Uporaba goriva dobre kvalitete, montaža novega seta vžigalnih svečk z pravilnim rangom vročine.



TOPLJENJE ELEKTRODA

Rastopljena masena i/ili centralna elektroda.

Vjerojatni uzrok: Efekt preranog pretpaljenja uzrokovan: pogrešno podešenim pretpaljenjem, preniskim oktanskim brojem goriva, oštećenim ili nebrtvčim ventilima, naslagama u komori za izgaranje ili svečici, pogrešnom toplinskom vrijednosti svečice ili usisnom granom koja ne brtvi.

Rezultati: Izostanak iskre. Neefikasno paljenje. Gubitak snage prije oštećenja motora.

Rješenje: Kompletan provjera sustava za paljenje. Korištenje odgovarajućeg goriva. Zamijeniti svečice nakon popravka

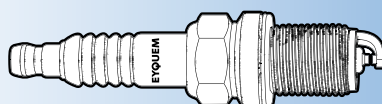

CONDITII NORMALE DE LUCRU

Culoarea izolatorului - alb spre gri / maro (mai accentuat la motoarele pe GPL) Indica o pornire buna la rece. Eficienta optima a motorului, consum minim de carburant, niveluri mici de poluare, protectie a sistemului catalitic

НОРМАЛНИ РАБОТНИ УСЛОВИЯ

Цветът на върха на изолатора варира от белезникав/сивокафяв до кафяв (по-подчертан при автомобили на газ).
 Резултати: Добър студен старт. Оптимална ефективност на двигателя, минимална консумация на бензин, най-ниски нива на замърсяване, предпазване на катализатора.

DEPUNERI DE CARBON

Electrozi acoperiti de depuneri Cauze probabile: Amestec bogat, exces de carburant. Filtru aer imbacsit. Reglaj gresit sau utilizare excesiva a socului. Utilizare indelungata in mediu urban.

Bujie aleasa incorect Rezultate: Performante slabe la pornire la rece (chiar imposibil de pornit). Rateuri, posibila defectiune a sistemului catalitic.

Exces de noxe, gaze de esapament Solutii: Montati un set nou de bujii, conforme motorului (respectand recomandarile) Reglati corect carburatia. Verificati filtrul de aer si schimbati-l daca e necesar. Resetati socul si evitati utilizarea excesiva a acestuia

ЗАМЪРСЯВАНЕ С ВЪГЛЕРОД

Искрящите краища на свещта са покрити със сажен нагар.
 Вероятни причини: Прекалено богата смес въздух/гориво. Задръстен филтър. Лоши настройки или продължителна употреба на смучач. Интензивна градска употреба (по този начин не позволява самопочистване чрез пирогенезация). Свещта е неправилно подбрана за двигателя и условията на експлоатация.
 Резултати: Лош студен старт (дори невъзможност за запалване). Лошо изгаряне, възможно повреждане на катализатора. Черни замърсяващи изгорели газове.
 Решения: Поставете нов комплект свещи съответстващи на изискванията на двигателя (винаги правете справка с препоръчаните диаграми). Регулирайте точно карбуратора. Проверете въздушния филтър и подменете, ако е необходимо. Регулирайте смучача и избягвайте продължително използване на ръчен смучач.

DPUNERI DE ULEI/HIDROCARBURI

Electrozi acoperiti de depuneri uleioase Cauze probabile: Exces de ulei in camera de ardere (nivel de ulei prea mare), segmenti uzati, camasi si/sau ghiduri supape uzate. Rezultate: Performante slabe de pornire la rece (chiar imposibil de pornit). Performante slabe la accelerare, rateuri. Instabilitate in functionarea motorului. Gaze de esapament albastrui, poluare

Solutii: Reconditionarea motorului, readucerea la cote standard. Verificati nivelul uleiului si schimbati-l daca este necesar. Montati un nou set de bujii.

НАГАР ОТ МАСЛО/ВЪГЛЕВОДОРОДИ

Искрящите краища на свещта са покрити с мазен/сажен нагар.
 Вероятни причини: Излишно масло в горивната камера (нивото на маслото прекалено високо), износени бутални пръстени и цилиндрични втулки и/или силно износени водачи на стержена на клапана.
 Резултати: Лош студен старт, неправилно изгаряне (дори невъзможност за запалване). Лошо ускорение, неправилно изгаряне. Лош празен ход (нестабилност на двигателя). Синкави изгорели газове и замърсяване на въздуха.
 Решения: Основен ремонт на двигателя, преоборудване към подходящите стандарти. Проверете точното ниво на маслото. Поставете нов комплект свещи.

SPECT STICLOS AL IZOLATORULUI

Izolator acoperit cu depuneri sticloase, violacee/galbui uneori verzui. Cauze probabile: Combustibil aditivat in exces depunerile apar dupa o defectare prealabila a bujiei urmata de turarea motorului (accelerari)

Rezultate: Rateuri, depunerile devin buni conductori la temperaturi inalte. Scanteia nu se mai formeaza intre electrozi. Distrugerii ale sistemului catalitic, poluare.

Solutii: montati un nou set de bujii. Respectati intocmai recomandarile constructorului in ce priveste carburantul utilizat.

ОСТЪКЛЯВАНЕ НА ИЗОЛАТОРА

Изолаторът се покрива със остъклен нагар, кафяво/жълти понякога зеленикави.
 Вероятни причини: Използваният бензин съдържа оловни добавки. Този нагар се получава след като свещта е била замърсена и след това двигателят е използван във условия на бързо ускорение.

Резултати: Лошо горене (нагарът става проводник на високо напрежение при висока температура). Искрата не се произвежда вече между електродите.
 Разрушаване на катализатора, замърсяване на въздуха.

Решения: Поставете нов комплект свещи. Винаги използвайте препоръчаното от производителя гориво за двигателя.

IZOLATOR CRAPAT SAU SPART

Cauze probabile: Soc mecanic, manuirea incorecta a bujiei. Autoaprinde cauzata de reglajul incorect al avansului sau de utilizarea de combustibil cu cifra octanica inferioara.

Rezultate: Rateuri. Deteriorarea sistemului catalitic. Posibile defectiuni ale motorului ca urmare a fenomenelor mecanice din camera de ardere

Solutii: Montati un nou set de bujii. Reglati aprinderea. Utilizati carburant cu cifra octanica adecvata

ПРОПУКАН ИЛИ СЧУПЕН ВРЪХ НА ИЗОЛАТОРА

Вероятни причини: Механичен удар, неправилно боравене със свещта. Тракането се дължи на неправилен реглаж на запалването или поради много ниско октаново число на горивото (причиняващо детонация).

Резултати: Лошо горене. Повреда на катализатора. Възможни сериозни повреди по двигателя от механично въздействие върху вътрешни отвори на горивната камера.

Решения: Поставете нов комплект свещи. Регулирайте запалването. Проверка на точността на октановото число.

ТОПИРЕА ELECTROZILOR.

Electrod central si/sau de masa - topit Cauze probabile: Preaprinde - fenomen cauzat de: reglaj incorect al aprinderii, utilizarea unui combustibil de calitate proasta, supape defecte, depuneri in camera de ardere sau pe bujii, gama de temperatura a bujiei nu corespunde cerintelor motorului, scurgeri in galeria de admisie.

Rezultate: lipsa scanteii, aprindere ineficienta, motorul pierde din putere.

Solutii: Revizuirea copleta a sistemului de aprindere. Utilizarea unui combustibil corespunzator calitativ. Montarea unui nou set de bujii alegand corect gama de temperatura.

СТОПЯВАНЕ НА ЕЛЕКТРОДИ

Стопен вършен и/или централен електрод.

Вероятни причини: Преждевременно запалване причинено от: грешна регулировка на запалването, използване на лошокачествен бензин, повредени клапани или без компресия, нагар в горивната камера, топлинното число на свещта не отговаря на изискванията на двигателя, навлизане на въздух в хранящия тръбопровод.

Резултати: Липса на искра. Недостатъчно запалване. Загуба на мощност преди повреда на двигателя.

Решения: Пълна проверка на системата на запалване. Използване на доброкачествено гориво. Поставете на нов комплект свещи с правилно топлинното число след ремонт на двигателя.

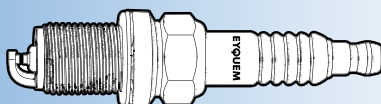

EYQUEM

GLOW PLUGS CATALOGUE
CATALOGUE DE BOUGIES
DE PRÉCHAUFFAGE

GLÜHKERZENKATALOG
CATÁLOGO DE BUJIAS
DE PRECALENTAMIENTO



293

EYQUEM

EYQUEM – a new generation of glow plugs for diesel engines, in a wide range covering all the requirements of the motoring world. Thanks to extensive experimentation Eyquem offers:

- Maximum speed in starting the engine in any environmental situation, from -20° to $+50^{\circ}$ C.
- Post-heating up to 300 seconds to regulate the rotation of the engine to “minimum” and reduce emissions of harmful exhaust gases.
- Reliability and durability under maximum thermal stress.

How to fit Eyquem glow plugs

Consult this catalogue carefully to select the glow plugs to install in your type of engine. Choosing the wrong plugs can cause serious damage to the plugs and/or the engine. When installing the plugs on the engine, it is advisable to fit and screw them in by hand and then tighten them with a dynamometric wrench to the values in the table below:

Thread	Tightening Torque max (Nm)
M10x1	15
UNF 3/8-24	15
M12x1,25	20

Advantages and guaranteed quality

- Threaded or quick-fit terminal protected against oxidization by zinc or nickel plating.
- Electrical isolation guaranteed by a specially shaped washer.
- Metallic shell protected against corrosion by blue zinc plating.
- Surface finishing (minimum roughness) of the conical seat of the shell to guarantee adequate sealing against the compressed gases in the combustion chamber or prechamber.

EYQUEM – la marque d'une nouvelle génération de bougies à incandescence pour moteurs diesels, dans une très vaste gamme pour satisfaire les demandes du marché mondial, résultat d'une expérimentation qui permet d'offrir:

- Meilleure rapidité de démarrage du moteur à n'importe quelle température ambiante de -20 à $+50^{\circ}$ C;
- Post-chauffage jusqu'à 300 secondes pour les moteurs écologiques dans le but de stabiliser le moteur au ralenti et de réduire l'émission de gaz nocifs à l'échappement;
- Fiabilité et durée aux contraintes thermiques maximales.

Pour monter correctement les bougies:

à l'aide du présent catalogue, choisir avec la meilleure attention les bougies à incandescence devant être montée sur le moteur spécifique. Toute application erronée risque d'endommager la bougie à incandescence et/ou le moteur. Lors du montage des bougies à incandescence sur le moteur, il est conseillé de les mettre en place et de les visser d'abord à la main et de les serrer ensuite à l'aide d'une clé dynamométrique en respectant les valeurs indiquées dans le tableau.

Filetage	Couple de serrage max (Nm)
M10x1	15
UNF 3/8-24	15
M12x1,25	20

Avantages et garantie de la qualité

- Raccordement fileté ou à emboîtement rapide (vis ou clips), protégé contre l'oxydation par galvanisation au zinc ou au nickel.
- Isolation électrique garantie par une rondelle à configuration spéciale.
- Corps métallique protégé contre la corrosion par zincage bleu.
- Finition superficielle, avec rugosité minimum, du siège conique du corps pour garantir une étanchéité adéquate aux gaz comprimés dans la chambre ou dans la préchambre de combustion.

EYQUEM - Die Marke einer neuen Generation von Glühkerzen für Dieselmotoren, die den Ansprüchen des weltweiten Marktes entspricht:

- Maximale Drehzahl beim Starten des Motors unter allen Umfeldbedingungen bei Temperaturen von -20° bis $+50^{\circ}$ C.
- Nachglühfähig bis zu 300 Sekunden. Dadurch werden in der Warmlaufphase weniger Schadstoffe ausgestoßen.
- Zuverlässigkeit und Langlebigkeit selbst unter maximaler thermischer Belastung.

Für eine korrekte Montage der Eyquem-Glühkerzen

Mit Hilfe des Katalogs sorgfältig die für den spezifischen Motor vorgesehene Glühkerze auswählen. Eine falsche Anwendung kann zu schweren Schäden an Glühkerze und/oder Motor führen.

Es wird empfohlen, die Glühkerzen beim Einbau in den Motor von Hand einzuschrauben und anschließend mit einem Drehmomentschlüssel entsprechend den in der Tabelle angegebenen Werten anzuziehen:

Gewinde	Drehmoment max. (Nm)
M10x1	15
UNF 3/8-24	15
M12x1,25	20

Vorteile und Qualitätsgarantie

- Glühkerzenanschluß mit Gewinde oder Steckverbindung, durch Nickel- oder Zinkbeschichtung vor Oxydation geschützt.
- Elektrische Isolierung durch Isolierscheibe aus speziellem Kunststoff.
- Glühkerzenkörper durch blaue Zinkbeschichtung vor Oxydation geschützt.
- Oberflächenbehandelt, minimale Unebenheiten am konischen Sitz des Gehäuses, um eine optimale Dichtigkeit der Verbrennungskammer oder Vorkammer zu garantieren.



EYQUEM – una nueva generación de bujías de precalentamiento para motores diesel, con una amplia gama que abarca todas las necesidades del mundo del motor:

- Máxima rapidez en la puesta en marcha del motor en cualquier ambiente, desde -20 hasta +50 °C
- Postcalentamiento hasta 300 segundos para regular la rotación del motor al "mínimo" y reducir las emisiones de gases de escape nocivos.
- Fiabilidad y duración bajo las mayores tensiones térmicas.

Cómo montar las bujías de precalentamiento Eyquem

Consulte atentamente este catálogo para seleccionar las bujías de precalentamiento que debe instalar en su tipo de motor. Una elección equivocada podría dañar gravemente las bujías y el motor.

Al instalar las bujías en el motor, es aconsejable montarlas y enroscarlas a mano y posteriormente apretarlas con una llave dinamométrica a los valores indicados en la tabla siguiente:

Rosca	Apriete Par máximo (Nm)
M10x1	15
UNF 3/8-24	15
M12x1,25	20

Ventajas y calidad garantizada

- Terminal roscado o de ajuste rápido protegido contra la oxidación mediante un recubrimiento de zinc o níquel.
- Aislamiento eléctrico garantizado mediante una arandela de forma especial.
- Carcasa metálica protegida contra la corrosión mediante un recubrimiento de zinc azul.
- Acabado superficial (rugosidad mínima) del asiento cónico de la carcasa para garantizar una adecuada hermeticidad frente a los gases comprimidos en la cámara o precámara de combustión.

EYQUEM – Il marchio di una nuova generazione di candele ad incandescenza per motori diesel, in una gamma molto ampia per soddisfare le richieste del mercato mondiale, risultato di una sperimentazione che permette di offrire:

- Massima rapidità d'avviamento del motore in ogni situazione ambientale da -20 a +50°C;
- Postriscaldamento fino a 300 secondi, per i motori ecologici, allo scopo di regolarizzare la rotazione del motore al "minimo" e ridurre l'emissione di gas nocivi allo scarico;
- Affidabilità e durata alle massime sollecitazioni termiche.

Per un corretto montaggio delle candele ad incandescenza

Utilizzando il presente catalogo, scegliere con la massima attenzione le candele ad incandescenza da installare sul motore specifico. L'errata applicazione può causare gravi danni alla candela ad incandescenza e/o al motore.

Nella fase di montaggio delle candele ad incandescenza su motore, è consigliabile inserirle ed avvitarle a mano, quindi serrarle con chiave dinamometrica rispettando i valori in tabella:

Filettatura	Coppia di torsione max (Nm)
M10x1	15
UNF 3/8-24	15
M12x1,25	20

Vantaggi e garanzia della qualità

- Terminale filettato o ad innesto rapido, protetto dall'ossidazione mediante zincatura o nichelatura
- Isolamento elettrico garantito da rondella con speciale configurazione
- Corpo metallico protetto dalla corrosione mediante zincatura trivalente
- Finitura superficiale, con minima rugosità, della sede conica del corpo per garantire l'adeguata tenuta ai gas compressi nella camera o pre-camera di combustione.

EYQUEM – uma nova geração de velas de incandescência para motores diesel, que apresenta uma vasta gama abrangendo todos os requisitos do mundo motorizado:

- Velocidade máxima no arranque do motor em qualquer tipo de ambiente de -20° a +50° C.
- Pós-aquecimento de até 300 segundos para regular a rotação do motor para o "mínimo" e reduzir as emissões de gases de escape nocivos.
- Fiabilidade e durabilidade em condições de esforço térmico máximo.

Como instalar as velas de incandescência Eyquem

Consulte este catálogo atentamente para seleccionar as velas de incandescência para instalar no seu tipo de motor. A escolha de velas de incandescência erradas pode provocar sérios danos nas velas e/ou no motor. Quando instalar as velas no motor, é aconselhável instalá-las e enroscá-las à mão e depois apertá-las com uma chave dinamométrica em conformidade com os valores apresentados na tabela seguinte:

Rosca	Aperto Binário máx. (Nm)
M10x1	15
UNF 3/8-24	15
M12x1,25	20

Vantagens e qualidade garantida

- Terminal roscado ou de instalação rápida protegido contra oxidação através de metalização de zinco ou níquel.
- Isolamento eléctrico garantido por uma anilha de formato especial.
- Encaixe metálico protegido contra corrosão através de metalização de zinco.
- Acabamento de superfície (rugosidade mínima) da sede cónica do encaixe para garantir uma vedação adequada contra os gases comprimidos na câmara ou na pré-câmara de combustão.

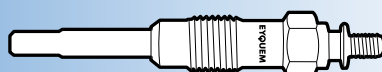

EYQUEM – to marka nowej generacji świec żarowych do silników Diesel'a, spełniająca najwyższe wymagania światowych rynków.

- Natychmiastowy rozruch niezależnie od warunków atmosferycznych, od -20° do + 50°C.
- Dogrzewanie do 300s powoduje zredukowanie do minimum nierównomierniej pracy silnika i znaczne ograniczenie emisji szkodliwych substancji.
- Niezawodność i długi okres eksploatacji, nawet przy maksymalnych obciążeniach termicznych.

Aby prawidłowo zamontować świece żarowe Eyquem.

Korzystając z katalogu należy dobrać odpowiednio świece żarowe dla danego typu silnika. Niewłaściwy wybór może doprowadzić do poważnego uszkodzenia świecy lub/i silnika.

Podczas montażu zaleca się wkręcić świecę ręcznie, a następnie dokręcić kluczem dynamometrycznym wg wartości wskazanych w tabeli.

Gwint	Moment dokręcania Max. (Nm)
M10x1	15
UNF 3/8-24	15
M12x1,25	20

Korzyści i gwarancja jakości.

- Gwintowana końcówka połączenia elektrycznego zabezpieczona jest przed utlenianiem przez niklowanie lub cynkowanie.
- Niezawodna izolacja elektryczna uzyskana dzięki specjalnie ukształtowanej podkładce.
- Metalowa część korpusu świecy zabezpieczona przed korozją przez cynkowanie.
- Wykończenie powierzchni (minimalna chropowatość) na stożkowej części korpusu zapewnia właściwe uszczelnienie w komorze spalania.

EYQUEM - μια νέα γενιά προθερμαντήρων για πετρελαιοκινητήρες σε μια πλήρη σειρά κωδικών και εφαρμογών. Χάρη στα εκτενή της πειράματα, η EYQUEM προσφέρει:

- Ταχύτατη εκκίνηση κινητήρα ανεξάρτητα συνθηκών περιβάλλοντος, από -20° έως + 50° c.
- Μεταθέρμανση μέχρι 300 δευτερόλεπτα ώστε να ρυθμίζονται οι στροφές του κινητήρα στο ελάχιστο και να μειώνονται οι εκπομπές καυσαερίων.
- Αξιοπιστία και αντοχή και σε μέγιστη θερμοκή καταπίεση.

Επιλογή και τοποθέτηση των Προθερμαντήρων EYQUEM.

Συμβουλευτείτε με προσοχή τον παρόντα κατάλογο για να επιλέξετε τον σωστό κωδικό προθερμαντήρα που αντιστοιχεί στον τύπο του πετρελαιοκινητήρα. Λανθασμένη επιλογή προθερμαντήρα μπορεί να προκαλέσει ζημιά στους προθερμαντήρες ή/και στον κινητήρα.

Για να τοποθετήσετε τους προθερμαντήρες στον κινητήρα, βιδώστε κατ' αρχήν τον προθερμαντήρα με το χέρι και στη συνέχεια σφίχτε τον με ένα δυναμόκλειδο σύμφωνα με τις πιο κάτω τιμές:

Τύπος Σπειρώματος	Ροπή Σύσφιξης Max. (Nm)
M10x1	15
ή UNF 3/8-24	15
M12x1,25	20

Πλεονεκτήματα και εξασφαλισμένη ποιότητα.

- Ακροδέκτης με βόλτα ή με φιν με επιμετάλλωση από ψευδάργυρο ή νικέλιο για προφύλαξη από οξειδωση.
- Ηλεκτρική μόνωση που εξασφαλίζεται από μια ροδέλα ειδικού σχήματος.
- Μεταλλικό σώμα με επιμετάλλωση από μπλέ ψευδάργυρο, κατά της οξειδωσης.
- Λείανση της επιφάνειας της κωνικής έδρας για εξασφάλιση πλήρους σφράγισης του χώρου καύσης ή του χώρου προθέρμανσης.

EYQUEM – nová generace žhavicích svíček pro vznětové motory, která díky svému širokému rozsahu pokrývá vsechny požadavky motoristického světa:

- Maximální rychlost startování motoru za jakéhokoli počasí, od -20 °C do +50 °C.
- Následné zahrívání až 300 sekund, aby se na "minimum" regulovalo otáčení motoru a snížilo uvolňování škodlivých výfukových plynu.
- Spolehlivost a trvanlivost při maximálním tepelném napětí.

Jak se montují žhavicí svíčky Eyquem

Pozorně si prostudujte tento katalog a vyberte si správné žhavicí svíčky pro instalaci do vašeho typu motoru. Výber nesprávných svíček může způsobit vážné poškození svíček a motoru. Při instalaci svíček do motoru se doporučuje namontovat je a zašroubovat ručně a poté je dotáhnout momentovým klíčem podle hodnot v níže uvedené tabulce:

Závit	Utahování Utahovací moment (Nm)
M10x1	15
UNF 3/8-24	15
M12x1,25	20

Výhody a zaručená kvalita

- Koncovka se závitom nebo pro rychlou montáž ochráněná proti oxidaci zinkováním nebo niklováním.
- Elektrická izolace je zaručena speciálně tvarovanou podložkou.
- Kovové pouzdro ochráněné proti korozi modrým pozinkováním.
- Povrchová úprava (minimální drsnost) kuželového sedla pouzdra pro zaručení dostatečného těsnění stlačených plynů ve spalovací komoře nebo předkomůrce.

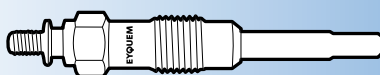

EYQUEM

Güncel araç parkının bütün ihtiyaçlarını karşılayabilecek geniş bir çeşit yelpazesi ile dizel motorlar için yeni nesil ısıtma bujileri. Eyquem'in geniş tecrübesi ile üretilen bu bujilerle:

- Motor -20° den + 50° C ye her türlü hava koşulunda çok hızlı bir şekilde çalışır.
- Motor çalıştıktan sonrada 300 saniyeye kadar ısıtma devam eder bu sayede motorun çalışması düzenlenir ve egzoztan zararlı gazların çıkması azalır.
- Çok yüksek termal stres altında bile güvenli ve dayanıklı bir kullanım sağlanır.

Eyquem ısıtma bujisi montajı:

Lütfen aracınızın motor tipine uygun doğru bujiyi seçmek için kataloğu dikkatlice inceleyin. Yanlış ısıtma bujisi seçilirse yalnızca buji bozulmakla kalmaz motorda da çok ciddi hasara yol açabilir. Montaj yaparken bujileri önce elinizle yerleştirip sıkıştırınız ve daha sonra bir tork anahtarı ile aşağıda tabloda verilen değerlerde sıkıştırınız.

Diş ölçüsü	Sıkıştırma Torku (Nm)
M10x1	15
UNF 3/8-24	15
M12x1,25	20

Kazanımlar ve kalite garantisi

- Dişli, veya fişli bağlantı uçları oksidasyona karşı çinko veya nikel kaplama ile korunur.
- Özel şekilli pul sayesinde kesin bir elektrik izolasyonu sağlanır.
- Metal difl kabuk çinko kaplama ile korozyona karşı korunur.
- Konik oturma noktasının yüksek yüzey kalitesi (en az pürüzlü) yanma odasından veya ön yanma odasından kompresyon gazlarının kaçmasını kesinlikle önler.

EYQUEM – nova generacija grijača za dieselske motore, u širokom spektru koji pokriva sve zahtjeve motoriziranog svijeta. Zahvaljujući intenzivnim istraživanjima Eyquem nudi:

- Maksimalnu brzinu pokretanja motora u bilo kojoj vremenskoj situaciji i na bilo kojoj temperaturi, od -20° do +50° C.
- Naknadno grijanje do 300 sekundi za regulaciju što nižeg broja okretaja u praznom hodu i za smanjenje emisije štetnih plinova.
- Pouzdanost i izdržljivost i pod najvećim termalnim opterećenjima.

Kako ugraditi Eyquem grijač

Za pravilan odabir i montažu Eyquem grijača pažljivo proučite ovaj katalog kako bi odabrali pravilan grijač za vaše vozilo. Izbor pogrešnih grijača može uzrokovati ozbiljna oštećenja grijača i/ili motora. Prilikom ugradnje grijača na motor, preporučljivo je rukom uvrnuti grijač i završno ga pritegnuti moment ključem na vrijednost momenta naveden u tabeli:

Navoj	Maksimalni pritezni moment (Nm)
M10x1	15
UNF 3/8-24	15
M12x1,25	20

Prednosti i zajamčena kvaliteta

- Priključak za napajanje zaštićen od oksidacije cinčanjem ili niklanjem.
- Električna izolacija zajamčena posebnom konstrukcijom pločice.
- Vrh grijača zaštićen od oksidacije plavim cinčanjem.
- Obrada površine (minimalne neravnine) konusnog ležišta tijela grijača jamči adekvatno brtvljenje plinova iz komore ili predkomore za izgaranje.

EYQUEM – o noua generație de bujii incandescente pentru motoarele diesel, într-o gamă largă ce acoperă toate cerințele pieței mondiale.

Mulțumită unei experimentări vaste, Eyquem vă oferă:

- Viteză maximă la pornirea motorului în orice condiții de mediu de la -20° la +50° C.
- Post încălzire de până la 300 de secunde pentru a regla turația motorului la "minim" și a reduce emisia gazelor nocive de echipament.
- Fiabilitate și durabilitate în condiții de stres termal maxim.

Cum se montează bujiile incandescente

Consultați acest catalog cu grijă pentru a selecta bujiile incandescente ce urmează a fi instalate în motorul Dvs. Alegerea unor bujii greșite poate cauza deteriorarea gravă a bujiilor și/sau a motorului

La instalarea bujiilor în motor, se recomandă să le introduceți și să le înșurubați cu mână și pe urmă să le strângeți cu o cheie dinamometrică la valorile din tabelul de mai jos:

	Cuplu de strângere max (Nm)
M10x1	15
UNF 3/8-24	15
M12x1,25	20

Avantaje și calitate garantată

- Terminal filetat sau cu montare rapidă protejat împotriva oxidării prin galvanizare cu zinc sau cu nichel.
- Izolare electrică garantată de o șabă cu formă specială.
- Înelșul metalic protejat împotriva coroziunii prin galvanizare cu zinc albastru.
- Finisarea de suprafață (rugozitate minimă) a corpului conic al învelișului garantează etanșeitate adecvată împotriva gazelor comprimate în camera de combustie sau în antecameră.

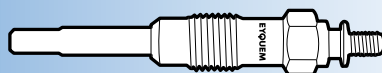

EYQUEM – едно ново поколение подгревни свещи за дизелови двигатели, широк асортимент, отговарящ на изискванията на производителите на двигатели. Благодарение на многобройните изпитания EYQUEM може да предложи:

- Максимална бързина на стартиране на двигателя при всякакви външни условия: от -20° to $+50^{\circ}$ C.
- Допълнително подгриване до 300 секунди за регулиране оборотите на двигателя до "минимум" и намаляване на емисиите от вредни газове..
- Надежност и продължителна работа при максималното топлинно натоварване.

Как се определят подходящите подгревни свещи EYQUEM.

Консултирайте се внимателно с този каталог, за да изберете подгревните свещи за вашия тип двигател. Изборът на неподходящи свещи може да причини сериозна повреда на свещите и/или на двигателя. Когато поставяте свещите на двигателя, препоръчително е да ги поставите и затегнете гна ръка" и след това да ги донатегнете с динамометричен ключ съгласно стойностите в долната таблица:

Резба	Момент на затягане Максимално усукване (Nm)
M10x1	15
UNF 3/8-24	15
M12x1,25	20

Предимства и гаранции за качество.

- Накрайник за кабел /резба или букса/, защитен от окисляване чрез цинково или никелово покритие.
- Ел. изолация, гарантирана от пръстен със специална форма.
- Метална обвивка, защитена срещу корозия чрез специално цинково покритие. Обработка повърхността / минимална грапавина / на коничното легло на корпуса с цел гарантиране на достатъчно уплътняване срещу компресираните газове в горивната камера или предкамерата.

EYQUEM – новое поколение свечей накаливания для дизельных двигателей, удовлетворяющее всем требованиям мирового автомобильного рынка. Благодаря постоянным исследованиям EYQUEM обеспечивает:

- максимальное число оборотов при старте двигателя в любых погодных условиях при температурах от -20° до $+50^{\circ}$ C.
- способность к последующему накаливанию до 300 секунд, что позволяет регулировать число оборотов до "минимума" и уменьшить выбросы вредных выхлопных газов
- надежность и долговечность при максимальных температурных нагрузках.

Как подобрать свечу накаливания EYQUEM

Внимательно изучите каталог и выберите свечу накаливания, предусмотренную для установки на Вашем типе двигателя. Неправильный выбор может вызвать серьезное повреждение свечей и/или двигателя. При установке рекомендуется сначала ввинтить свечу накаливания в блок цилиндров двигателя рукой до упора, после чего подтянуть динамометрическим ключом в соответствии с указанными в таблице параметрами:

Резьба	Максимальный момент затяжки (Нм)
M10x1	15
UNF 3/8-24	15
M12x1,25	20

Преимущества и гарантии качества:

- соединительный стержень с резьбой или штекерное соединение, защищенные от окисления цинковым или никелевым покрытием
- электрическая изоляция с помощью изоляционной шайбы из специального синтетического материала
- корпус свечи, защищенный от коррозии синим цинковым покрытием
- поверхность обработана с целью обеспечения минимальных шероховатостей на конической фаске корпуса для гарантии оптимальной герметизации камеры сгорания или предкамеры



New references / Nouvelles références

Neue Type / Nuevas referencias



BMW								
1 (F20)	114 d	1496	70	06.2015		B37 D15 A	2	GPE 91
	116 d	1496	85	03.2015		B37 D15 A	2	GPE 91
	116 d	1598	85	11.2012		N47 D16 A	2	GPE 91
	116 d	1995	85	12.2010		N47 D20 C	2	GPE 91
1 (F21)	114 d	1496	70	06.2015		B37 D15 A	2	GPE 91
	116 d	1496	85	03.2015		B37 D15 A	2	GPE 91
	116 d	1598	85	12.2011		N47 D16 A	2	GPE 91
	116 d	1995	85	01.2012		N47 D20 C	2	GPE 91
2 Active Tourer (F45)	214 d	1496	70	07.2014	02.2018	B37 C15 A	2	GPE 91
	216 d	1496	85	03.2014		B37 C15 A	2	GPE 91
2 Gran Tourer (F46)	214 d	1496	70	07.2015	02.2018	B37 C15 A	2	GPE 91
	216 d	1496	85	08.2014		B37 C15 A	2	GPE 91

CITROËN								
C5 II (RC_)	2.2 HDi	2179	125	04.2006		4HT (DW12BTED4)	4	G 88
C5 III (RD)	2.2 HDi	2179	125	02.2008		4HT (DW12BTED4)	4	G 88
C5 II Break (RE_)	2.2 HDi (RE)	2179	120	05.2006		4HP/4HR (DW12BTED4)	4	G 88
	2.2 HDi (RE)	2179	125	04.2006		4HT (DW12BTED4)	4	G 88
C5 III Break (RW_)	2.2 HDi	2179	125	02.2008		4HT (DW12BTED4)	4	G 88
	2.2 HDi 165	2179	120	02.2008		4HP (DW12BTED4)	4	G 88
C6 (TD_)	2.2 HDi	2179	120	06.2006		4HP (DW12BTED4)	4	G 88
	2.2 HDi	2179	125	06.2006		4HT (DW12BTED4)	4	G 88
C8 (EA_, EB_)	2.2 HDi	2179	120	06.2007		4HP/4HR (DW12BTED4)	4	G 88
	2.2 HDi	2179	125	06.2006		4HT (DW12BTED4)	4	G 88
C-CROSSER (EP_)	2.2 HDi	2179	115	02.2007		4HN (DW12MTED4)	4	G 88
JUMPER Autobus	2.2 HDi 110	2198	81	07.2011		4HG (P22DTE)	4	GPE 92
	2.2 HDi 130	2198	96	07.2011		4HH (P22DTE)	4	GPE 92
	2.2 HDi 150	2198	110	07.2011		4HJ (P22DTE)	4	GPE 92
JUMPER Camionnette	2.2 HDi 110	2198	81	07.2011		4HG (P22DTE)	4	GPE 92
	2.2 HDi 130	2198	96	07.2011		4HH (P22DTE)	4	GPE 92
	2.2 HDi 150	2198	110	07.2011		4HJ (P22DTE)	4	GPE 92
JUMPER Camion/Plate-forme	2.2 HDi 110	2198	81	07.2011		4HG (P22DTE)	4	GPE 92
	2.2 HDi 130	2198	96	07.2011		4HH (P22DTE)	4	GPE 92
	2.2 HDi 150	2198	110	07.2011		4HJ (P22DTE)	4	GPE 92

FIAT								
ULYSSE (179AX)	2.2 D Multijet	2179	125	03.2008	06.2011	4HS/4HT (DW12BTED4)	4	G 88
	2.2 JTD	2179	120	03.2008	06.2011	4HP/4HR	4	G 88

FORD								
GALAXY (WA6)	2.2 TDCi	2179	129	03.2008	12.2012	Q4BA/Q4WA	4	G 88
MONDEO IV (BA7)	2.2 TDCi	2179	129	03.2008	10.2010	Q4BA	4	G 88
MONDEO IV A (BA7)	2.2 TDCi	2179	129	03.2008	10.2010	Q4BA	4	G 88
MONDEO IV Turnier (BA7)	2.2 TDCi	2179	129	03.2008	10.2010	Q4BA	4	G 88
RANGER (TKE)	2.2 TDCi	2198	88	04.2011		GBVAJPF	4	GPE 92
	2.2 TDCi, 4x4	2198	92	04.2011		GBVAJQW	4	GPE 92
	2.2 TDCi	2198	110	11.2011		GBVAJQJ	4	GPE 92
	2.2 TDCi 4x4	2198	110	04.2011		GBVAJQJ	4	GPE 92
	3.2 TDCi 4x4	3198	147	04.2011		SAFA	5	GPE 92
S-MAX (WA6)	2.2 TDCi	2179	129	03.2008	12.2012	Q4WA	4	G 88
TOURNEO CUSTOM Bus	2.2 TDCi	2198	74	04.2012		DRFG/DRFF/DRF4	4	GPE 92
	2.2 TDCi	2198	92	04.2012		CYFA/CYFF	4	GPE 92
	2.2 TDCi	2198	114	04.2012		CVFF	4	GPE 92
TRANSIT Bus	2.2 TDCi	2198	74	08.2013		DRF5/DRFG/DRFF	4	GPE 92
	2.2 TDCi	2198	92	08.2013		CYF5/CYFG/CY14	4	GPE 92

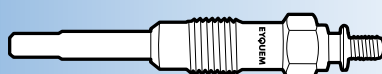

**kw****Cyl.****FORD**

	2.2 TDCi	2198	114	12.2014		CVF5	4	GPE 92
	2.2 TDCi 4x4	2198	92	08.2013		CYR5/CY24	4	GPE 92
	2.2 TDCi RWD	2198	74	08.2013		DRR5	4	GPE 92
	2.2 TDCi RWD	2198	92	08.2013		USR6	4	GPE 92
	2.2 TDCi RWD	2198	114	08.2013		CVR5/UJR6	4	GPE 92
	2.2 TDCi AWD	2198	114	12.2014		CVR5	4	GPE 92
TRANSIT Bus (FD_., FB_., FS_., FZ_., FC_.)	2.2 TDCi	2198	63	04.2006	08.2014	P8FA/P8FB	4	GPE 92
	2.2 TDCi	2198	74	10.2011	08.2014	DFRA/DFRB/DFRC/DFRE	4	GPE 92
	2.2 TDCi	2198	81	04.2006	08.2014	QVFA	4	GPE 92
	2.2 TDCi	2198	85	10.2011	08.2014	DSL version	4	GPE 92
	2.2 TDCi	2198	92	10.2011	08.2014	CYFA/CYFB/CYFC/CYFD	4	GPE 92
	2.2 TDCi	2198	96	04.2006	08.2014	QWFA	4	GPE 92
	2.2 TDCi	2198	103	10.2007	08.2011	PGFA/PGFB/UHFA/UHFB/UHFC	4	GPE 92
	2.2 TDCi RWD	2198	74	10.2011	08.2014	DFRA/DFRB/DFRC	4	GPE 92
	2.2 TDCi RWD	2198	92	10.2011	08.2014	CYRA	4	GPE 92
	2.2 TDCi RWD	2198	100	09.2011	08.2014	USRA/USRB	4	GPE 92
TRANSIT Camionnette	2.2 TDCi	2198	74	08.2013		DRF5/DRFG/DRFF	4	GPE 92
	2.2 TDCi	2198	92	08.2013		CYF5/CYFG/CY14	4	GPE 92
	2.2 TDCi	2198	114	08.2013		CVF5	4	GPE 92
	2.2 TDCi 4x4	2198	92	08.2013		CYR5	4	GPE 92
	2.2 TDCi 4x4	2198	114	08.2013		CVR5	4	GPE 92
	2.2 TDCi RWD	2198	74	08.2013		DRR5	4	GPE 92
	2.2 TDCi RWD	2198	92	08.2013		CYR5/USR6	4	GPE 92
	2.2 TDCi RWD	2198	114	08.2013		CVR5/UJR6	4	GPE 92
TRANSIT Camionnette (FA_.)	2.2 TDCi	2198	63	10.2011	08.2014	DSL version	4	GPE 92
	2.2 TDCi	2198	74	10.2011	08.2014	DRFA/DRFB/DRFC/DRFD/DRFE	4	GPE 92
	2.2 TDCi	2198	81	04.2006	08.2014	QVFA	4	GPE 92
	2.2 TDCi	2198	85	10.2008	08.2014	SRFA/SRFB/SRFC/SRFD/SRFE	4	GPE 92
	2.2 TDCi	2198	92	10.2011	08.2014	CYFA/CYFB/CYFC/CYFD	4	GPE 92
	2.2 TDCi	2198	96	10.2011	08.2014	DSL version	4	GPE 92
	2.2 TDCi	2198	103	10.2011	08.2014	DSL version	4	GPE 92
	2.2 TDCi 4x4	2198	92	10.2011	08.2014	CYRB/CYRC	4	GPE 92
	2.2 TDCi RWD	2198	74	10.2011	08.2014	DFRA/DFRB/DFRC	4	GPE 92
	2.2 TDCi RWD	2198	92	10.2011	08.2014	CYRA	4	GPE 92
	2.2 TDCi RWD	2198	110	10.2011		CVRA/CVRB/CVRC	4	GPE 92
TRANSIT Camion/Plate-forme	2.2 TDCi	2198	74	08.2013		DRF5/DRFG/DRFF	4	GPE 92
	2.2 TDCi	2198	92	08.2013		CYF5	4	GPE 92
	2.2 TDCi	2198	114	08.2013		CVF5	4	GPE 92
	2.2 TDCi 4x4	2198	92	08.2013		CYR5	4	GPE 92
	2.2 TDCi 4x4	2198	114	08.2013		CVR5	4	GPE 92
	2.2 TDCi RWD	2198	74	08.2013		DRR5	4	GPE 92
	2.2 TDCi RWD	2198	92	08.2013		USR6	4	GPE 92
	2.2 TDCi RWD	2198	114	08.2013		CVR5/UJR6	4	GPE 92
TRANSIT Camion/Plate-forme (FM_., FN_.)	2.2 TDCi	2198	63	04.2006	08.2014	P8FA/P8FB	4	GPE 92
	2.2 TDCi	2198	74	04.2006	08.2014	DRFA/DRFB/DRFC/DRFD/DRFE	4	GPE 92
	2.2 TDCi	2198	81	04.2006	08.2014	QVFA	4	GPE 92
	2.2 TDCi	2198	85	10.2008	08.2014	SRFA/SRFB/SRFC/SRFD/SRFE	4	GPE 92
	2.2 TDCi	2198	92	10.2011	08.2014	CYFA/CYFB/CYFC/CYFD	4	GPE 92
	2.2 TDCi	2198	96	10.2011	08.2014	DSL version	4	GPE 92
	2.2 TDCi 4x4	2198	92	10.2011	08.2014	CYRB/CYRC	4	GPE 92
	2.2 TDCi RWD	2198	74	10.2011	08.2014	DRRA/DRRB/DRRC	4	GPE 92
	2.2 TDCi RWD	2198	92	10.2011	08.2014	CYRA	4	GPE 92
	2.2 TDCi RWD	2198	114	10.2011	08.2014	CVRA/CVRB/CVRC	4	GPE 92
TRANSIT CUSTOM Bus	2.2 TDCi	2198	74	04.2012		DRF4/DRFF/DRFG	4	GPE 92
	2.2 TDCi	2198	92	04.2012		CYF4/CYFF	4	GPE 92
	2.2 TDCi	2198	114	04.2012		CVFF	4	GPE 92
TRANSIT CUSTOM Camionnette	2.2 TDCi	2198	74	04.2012		DRF4/DRFF/DRFG	4	GPE 92
	2.2 TDCi	2198	92	04.2012		CYF4/CYFF	4	GPE 92
	2.2 TDCi	2198	114	04.2012		CVFF	4	GPE 92

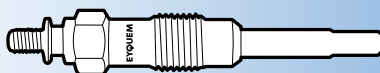



kW



Cyl.

**FORD**

TRANSIT TOURNEO	2.2 TDCi	2198	81	10.2011		DSL version	4	GPE 92
	2.2 TDCi	2198	85	10.2011	08.2014	DSL version	4	GPE 92
	2.2 TDCi	2198	96	10.2011		DSL version	4	GPE 92
	2.2 TDCi	2198	103	10.2011		DSL version	4	GPE 92

JAGUAR

XF (X250)	2.2 D	2179	120	04.2011	04.2015	224DT	4	G 88
	2.2 D	2179	140	05.2011	04.2015	224DT	4	G 88
	2.2 D	2179	147	03.2012	04.2015	224DT	4	G 88
XF SPORTBAKE (X250)	2.2 D	2179	120	09.2012	04.2014	224DT	4	G 88
	2.2 D	2179	147	09.2012	04.2014	224DT	4	G 88

LANCIA

PHEDRA (179_)	2.2 D Multijet	2179	125	03.2008	11.2010	4HS/4HT	4	G 88
	2.2 JTD	2179	120	04.2006	11.2010	4HP/4HR	4	G 88

LAND ROVER

FREELANDER 2 (L359)	2.2 Ed4	2179	110	08.2010	10.2014	224DT (DW12BTED4)	4	G 88
	2.2 SD4 4x4	2179	140	08.2010	10.2014	224DT	4	G 88
	2.2 TD4 4x4	2179	110	10.2006	10.2014	224DT (DW12BTED4)	4	G 88
	2.2 TD4 4x4	2179	112	01.2007	10.2014	224DT chassis n°->AH999999	4	G 88
	2.2 TD4 4x4	2179	115	10.2006	10.2014	224DT chassis n°->AH999999	4	G 88
	2.2 TD4 4x4	2179	118	10.2006	10.2014	224DT chassis n°->AH999999	4	G 88
RANGE ROVER EVOQUE (L538)	2.2 D, 4x4	2179	110	06.2011		224DT	4	G 88
	2.2 D 4x4	2179	140	06.2011		224DT	4	G 88

MERCEDES

C-CLASS (W205)	C 180 BlueTEC / d (205.036)	1598	85	05.2014		OM 626.951	4	GPE 93
	C 200 BlueTEC / d (205.037)	1598	100	05.2014		OM 626.951	4	GPE 93
C-CLASS T-Model (S205)	C 180 BlueTEC / d (205.036)	1598	85	09.2014		OM 626.951	4	GPE 93
	C 200 BlueTEC / d (205.037)	1598	100	09.2014		OM 626.951	4	GPE 93

MINI

MINI (F55)	Cooper D	1496	85	10.2013		B37 C15 A	3	GPE 91
	One D	1496	70	02.2014		B37 C15 A	3	GPE 91
MINI (F56)	Cooper D	1496	85	12.2013		B37 C15 A	3	GPE 91
	One D	1496	70	07.2013		B37 C15 A	3	GPE 91
MINI (R56)	Cooper D	1598	82	06.2010	11.2013	N47 C16 A (OE: 12 23 7 798 001)	4	GPE 91
	Cooper D	1995	82	02.2011	11.2013	N47 C20 A (OE: 12 23 7 798 001)	4	GPE 91
	Cooper SD	1995	100	02.2011	11.2013	N47 C20 A (OE: 12 23 7 798 001)	4	GPE 91
	Cooper SD	1995	105	02.2011	11.2013	N47 C20 A (OE: 12 23 7 798 001)	4	GPE 91
	One D	1598	66	07.2010	11.2013	N47 C16 A (OE: 12 23 7 798 001)	4	GPE 91
MINI Cabriolet (F57)	Cooper D	1496	85	12.2014		B37 C15 A	3	GPE 91
MINI Cabriolet (R57)	Cooper D	1598	82	05.2009	11.2013	N47 C16 A	4	GPE 91
	Cooper D	1995	82	02.2011	05.2015	N47 C20 A	4	GPE 91
	Cooper SD	1995	105	06.2009	05.2015	N47 C20 A	4	GPE 91
MINI CLUBMAN (R55)	Cooper D	1598	82	03.2010	06.2014	N47 C16 A	4	GPE 91
	Cooper D	1995	82	02.2011	06.2014	N47 C20 A	4	GPE 91
	Cooper SD	1995	100	02.2011	06.2014	N47 C20 A	4	GPE 91
	Cooper SD	1995	105	02.2011	06.2014	N47 C20 A	4	GPE 91
	One D	1598	66	03.2010	06.2014	N47 C16 A	4	GPE 91
MINI CLUBVAN (R55)	Cooper D	1598	82	12.2012	06.2014	N47 C16 A	4	GPE 91
	Cooper D	1995	82	12.2012	06.2014	N47 C20 A	4	GPE 91
MINI COUNTRYMAN (F60)	One D	1496	85	07.2017		B37 C15 A	2	GPE 91
MINI COUNTRYMAN (R60)	Cooper D	1598	82	01.2010	10.2016	N47 C16 A	4	GPE 91
	Cooper D	1995	82	01.2010	10.2016	N47 C20 A	4	GPE 91
	Cooper D ALL4	1598	82	01.2010	09.2016	N47 C16 A	4	GPE 91

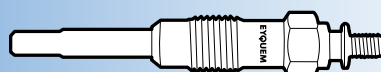



kW



Cyl.



MINI

	Cooper D ALL4	1995	82	07.2010	09.2016	N47 C20 A	4	GPE 91
	Cooper SD	1995	105	01.2010	10.2016	N47 C20 A (OE: 12 23 7 798 001)	4	GPE 91
	Cooper SD ALL4	1995	100	01.2010	10.2016	N47 C20 A (OE: 12 23 7 798 001)	4	GPE 91
	Cooper SD ALL4	1995	105	01.2010	10.2016	N47 C20 A (OE: 12 23 7 798 001)	4	GPE 91
	One D	1598	66	01.2010	10.2016	N47 C16 A	4	GPE 91
MINI Coupe (R58)	Cooper SD	1995	100	12.2010	05.2015	N47 C20 A	4	GPE 91
	Cooper SD	1995	105	12.2010	05.2015	N47 C20 A	4	GPE 91
MINI PACEMAN (R61)	Cooper D	1598	82	04.2012	09.2016	N47 C16 A	4	GPE 91
	Cooper D	1995	82	07.2012	09.2016	N47 C20 A	4	GPE 91
	Cooper D ALL4	1598	82	04.2012	09.2016	N47 C16 A	4	GPE 91
	Cooper D ALL4	1995	82	03.2012	09.2016	N47 C20 A	4	GPE 91
	Cooper SD	1995	105	03.2012	09.2016	N47 C20 A	4	GPE 91
	Cooper SD ALL4	1995	105	04.2012	09.2016	N47 C20 A	4	GPE 91
MINI ROADSTER (R59)	Cooper SD	1995	100	11.2011	04.2015	N47 C20 A	4	GPE 91
	Cooper SD	1995	105	11.2011	04.2015	N47 C20 A	4	GPE 91

MITSUBISHI

OUTLANDER II (CW_W)	2.2 DI-D 4WD	2179	115	08.2007	11.2012	4HN/4HK	4	G 88
---------------------	--------------	------	-----	---------	---------	---------	---	------

NISSAN

NP 300 NAVARA (D40)	2.5 dCi	2488	106	11.2011		YD25DDTi (OE : 1106500Q0H-1106500Q0L)	4	GPE 93
	2.5 dCi 4WD	2488	106	11.2011		YD25DDTi (OE : 1106500Q0H-1106500Q0L)	4	GPE 93
	2.5 dCi 4WD	2488	126	11.2011		YD25DDTi (OE : 1106500Q0H-1106500Q0L)	4	GPE 93
	2.5 dCi 4WD	2488	128	11.2011		YD25DDTi (OE : 1106500Q0H-1106500Q0L)	4	GPE 93
	2.5 dCi 4WD (D40DT, D40T, D40M, D40BB)	2488	140	11.2011		YD25DDTi (OE : 1106500Q0H-1106500Q0L)	4	GPE 93
NP 300 NAVARA Camion/plate-forme (D40)	2.5 dCi	2488	140	11.2011		YD25DDTi (OE : 1106500Q0H-1106500Q0L)	4	GPE 93
PATHFINDER III (R51)	2.5 dCi 4WD	2488	120	11.2011		YD25DDTi (OE : 1106500Q0H-1106500Q0L)	4	GPE 93
	2.5 dCi 4WD	2488	126	11.2011		YD25DDTi (OE : 1106500Q0H-1106500Q0L)	4	GPE 93
	2.5 dCi 4WD	2488	128	11.2011		YD25DDTi (OE : 1106500Q0H-1106500Q0L)	4	GPE 93
	2.5 dCi 4WD	2488	140	11.2011		YD25DDTi (OE : 1106500Q0H-1106500Q0L)	4	GPE 93
QASHQAI / QASQAI +2 I (J10-JJ10)	1.6 dCi	1598	96	10.2011	12.2013	R9M	4	GPE 93
	1.6 dCi 4WD	1598	96	10.2011	12.2013	R9M	4	GPE 93
QASHQAI II (J11, J11)	1.6 dCi	1598	96	11.2013		R9M	4	GPE 93
	1.6 dCi ALL MODE 4x4-i	1598	96	11.2013		R9M	4	GPE 93
X-TRAIL (T32)	1.6 dCi (T32)	1598	96	04.2014		R9M	4	GPE 93
	1.6 dCi (NT32)	1598	96	04.2014		R9M	4	GPE 93

OPEL

ASTRA J GTC	1.6 CDTi (08)	1598	81	07.2014		B 16 DTL	4	GPE 94
	1.6 CDTi (08)	1598	100	01.2014		B 16 DTH	4	GPE 94
	1.7 CDTi	1686	81	10.2011		A 17 DTC	4	GPE 90
	1.7 CDTi	1686	96	10.2011		A 17 DTS	4	GPE 90
ASTRA J (P10)	1.6 CDTi (68)	1598	81	02.2014		B 16 DTL	4	GPE 94
	1.6 CDTi (68)	1598	100	01.2014		B 16 DTH	4	GPE 94
	1.7 CDTi	1686	81	12.2009		A 17 DTC	4	GPE 90
	1.7 CDTi	1686	96	12.2009		A 17 DTS	4	GPE 90
ASTRA JA	1.6 CDTi (69)	1598	81	04.2014		B 16 DTL	4	GPE 94
	1.6 CDTi (69)	1598	100	01.2014		B 16 DTH	4	GPE 94
	1.7 CDTi	1686	81	06.2012		A 17 DTC	4	GPE 90
	1.7 CDTi	1686	96	06.2012		A 17 DTS	4	GPE 90
ASTRA J Sports Tourer (P10)	1.6 CDTi (35)	1598	81	02.2014		B 16 DTL	4	GPE 94
	1.6 CDTi (35)	1598	100	01.2014		B 16 DTH	4	GPE 94
	1.7 CDTi	1686	81	10.2010		A 17 DTC	4	GPE 90





kW



Cyl.



OPEL

	1.7 CDTi	1686	96	10.2010		A 17 DTS	4	GPE 90
ASTRA K (B16)	1.6 CDTi (68)	1598	70	06.2015		B 16 DTE	4	GPE 94
	1.6 CDTi (68)	1598	81	06.2015		B 16 DTU	4	GPE 94
	1.6 CDTi (68)	1598	100	06.2015		B 16 DTH	4	GPE 94
	1.6 CDTi (68)	1598	118	11.2015		B 16 DTR	4	GPE 94
ASTRA K Sports Tourer (B16)	1.6 CDTi (35)	1598	70	11.2015		B 16 DTE	4	GPE 94
	1.6 CDTi (35)	1598	81	11.2015		B 16 DTU-B 16 DTE	4	GPE 94
	1.6 CDTi (35)	1598	100	11.2015		B 16 DTH	4	GPE 94
	1.6 CDTi (35)	1598	118	11.2015		B 16 DTR	4	GPE 94
INSIGNIA B Grand Sport (Z18)	1.6 CDTi (68)	1598	81	03.2017		B 16 DTE- D 16 DTE	4	GPE 94
	1.6 CDTi (68)	1598	100	03.2017		B 16 DTH- D 16 DTH	4	GPE 94
INSIGNIA B Sports Tourer (Z18)	1.6 CDTi (35)	1598	81	03.2017		B 16 DTE- D 16 DTE	4	GPE 94
	1.6 CDTi (35)	1598	100	03.2017		B 16 DTH- D 16 DTH	4	GPE 94
CORSA D (S07)	1.7 CDTi	1686	96	06.2010		A 17 DTS	4	GPE 90
MERIVA B (S10)	1.6 CDTi (75)	1598	70	01.2014		B 16 DTC	4	GPE 94
	1.6 CDTi (75)	1598	81	03.2014		B 16 DTL-DTE-DTN	4	GPE 94
	1.6 CDTi (75)	1598	100	08.2013		B 16 DTH	4	GPE 94
	1.7 CDTi	1686	81	06.2010		A 17 DTC	4	GPE 90
MOKKA / MOKKA X (J13)	1.7 CDTi	1686	96	06.2010		A 17 DTS	4	GPE 90
	1.6 CDTi (_76)	1598	100	01.2015		B 16 DTH	4	GPE 94
	1.6 CDTi 4x4 (_76)	1598	100	01.2015		B 16 DTH	4	GPE 94
	1.7 CDTi	1686	96	11.2012		A 17 DTS	4	GPE 90
VIVARO A Camion/Plate-forme (X83)	1.7 CDTi 4x4	1686	96	11.2012		A 17 DTS	4	GPE 90
	2.0 CDTi	1995	66	12.2011		M9R 630	4	GPE 93
VIVARO A Camionnette (X83)	2.0 CDTi	1995	84	12.2011		M9R 630	4	GPE 93
	2.0 CDTi (F7)	1995	66	12.2011		M9R 630	4	GPE 93
VIVARO A Combi (X83)	2.0 CDTi (F7)	1995	84	12.2011		M9R 692	4	GPE 93
	2.0 CDTi (F7, J7, A07)	1995	84	12.2011		M9R 630 - M9R 692	4	GPE 93
ZAFIRA TOURER C (P12)	1.6 CDTi (75)	1598	88	07.2014		B 16 DTJ	2	GPE 94
	1.6 CDTi (75)	1598	100	02.2013		B 16 DTH	2	GPE 94

PEUGEOT

407 (6D_)	2.2 HDi	2179	120	06.2008		4HP (DW12BTED4)	4	G 88
	2.2 HDi 170	2179	125	05.2006		4HT (DW12BTED4)	4	G 88
407 SW (6E_)	2.2 HDi	2179	120	06.2008		4HP (DW12BTED4)	4	G 88
	2.2 HDi 170	2179	125	05.2006		4HT (DW12BTED4)	4	G 88
4007 (GP_)	2.2 HDi	2179	115	02.2007		4HN/4HK (DW12MTED4)	4	G 88
607 (9D, 9U)	2.2 HDi	2179	125	05.2006	06.2010	4HT (DW12BTED4)	4	G 88
807 (E)	2.2 HDi	2179	125	06.2006		4HT (DW12BTED4)	4	G 88
BOXER Bus	2.2 HDi 110	2198	81	03.2011		4HG (P22DTE)	4	GPE 92
	2.2 HDi 130	2198	96	03.2011		4HH (P22DTE)	4	GPE 92
	2.2 HDi 150	2198	110	03.2011		4HJ (P22DTE)	4	GPE 92
BOXER Camionnette	2.2 HDi 110	2198	81	03.2011		4HG (P22DTE)	4	GPE 92
	2.2 HDi 130	2198	96	03.2011		4HH (P22DTE)	4	GPE 92
	2.2 HDi 150	2198	110	03.2011		4HJ (P22DTE)	4	GPE 92
BOXER Camion/Plate-forme	2.2 HDi 110	2198	81	03.2011		4HG (P22DTE)	4	GPE 92
	2.2 HDi 130	2198	96	03.2011		4HH (P22DTE)	4	GPE 92
	2.2 HDi 150	2198	110	03.2011		4HJ (P22DTE)	4	GPE 92

RENAULT

ESPACE IV (JK0/1_)	2.0 dCi (JK02, JK03)	1995	96	01.2006		OE : 110651749R	4	GPE 93
	2.0 dCi (JK01, JK02, JK1J, JK1K)	1995	110	01.2006		OE : 110651749R	4	GPE 93
	2.0 dCi (JK03, JK04)	1995	127	01.2006		OE : 110651749R	4	GPE 93
ESPACE V (JR_)	1.6 dCi 130	1598	96	06.2015		R9M 409	4	GPE 93
	1.6 dCi 160	1598	118	06.2015		R9M 452	4	GPE 93
FLUENCE (L3)	1.6 dCi	1598	96	07.2014		R9M 402	4	GPE 93
GRAND SCÉNIC III (JZ0/1_)	1.6 dCi (JZ00, JZ12)	1598	96	04.2011		R9M 402-404-414	4	GPE 93
GRAND SCÉNIC IV (R9_)	1.6 dCi 130	1598	96	09.2016		R9M 409	4	GPE 93
	1.6 dCi 160	1598	118	09.2016		R9M 452	4	GPE 93
KADJAR (HA_, HL_)	1.6 dCi 130	1598	96	06.2015		R9M 414	4	GPE 93

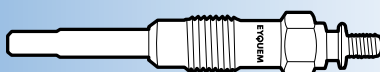



kW



Cyl.



RENAULT

	1.6 dCi 130 4x4	1598	96	06.2015	R9M 414	4	GPE 93
KOLEOS II	1.6 dCi 130	1598	96	08.2016	R9M 409-414	4	GPE 93
LAGUNA III (BT0/1)	2.0 dCi (BT07, BT0J, BT14, BT1A, BT1S, ...)	1995	96	10.2007	OE: 110651749R	4	GPE 93
	2.0 dCi (BT01, BT08, BT09, BT0E, BT0K, ...)	1995	110	10.2007	OE: 110651749R	4	GPE 93
	2.0 dCi (BT0M, BT0N, BT0S, BT19, BT1F)	1995	127	01.2008	OE: 110651749R	4	GPE 93
	2.0 dCi GT (BT11, BT1E, BT1N)	1995	131	03.2008	OE: 110651749R	4	GPE 93
LAGUNA III Grandtour (KT0/1)	2.0 dCi (KT07, KT0J, KT14, KT1A, KT1S)	1995	96	10.2007	OE: 110651749R	4	GPE 93
	2.0 dCi (KT01, KT08, KT09, KT0K, KT12, ...)	1995	110	10.2007	OE: 110651749R	4	GPE 93
	2.0 dCi (KT0M, KT0N, KT0S, KT19, KT1F)	1995	127	01.2008	OE: 110651749R	4	GPE 93
	2.0 dCi GT (KT11, KT1E, KT1N)	1995	131	03.2008	OE: 110651749R	4	GPE 93
LAGUNA Coupé (DT0/1)	2.0 dCi (DT01, DT08, DT09, DT0K, DT12, ...)	1995	110	09.2008	OE: 110651749R	4	GPE 93
	2.0 dCi (DT0M, DT0N, DT0S, DT19, DT1F)	1995	127	09.2008	OE: 110651749R	4	GPE 93
	2.0 dCi GT (DT11, DT1E, DT1N)	1995	131	09.2008	OE: 110651749R	4	GPE 93
LATITUDE (L70_)	2.0 dCi 150 (L70H)	1995	110	02.2011	OE: 110651749R	4	GPE 93
	2.0 dCi 175 (L70Y)	1995	127	05.2001	OE: 110651749R	4	GPE 93
	2.0 dCi	1995	130	02.2011	OE: 110651749R	4	GPE 93
MASTER III Bus (JV)	2.3 dCi 100 FWD (JVOA, JVOB)	2298	74	02.2011	OE: 110651492R	4	GPE 93
	2.3 dCi 110 FWD	2298	81	09.2014	OE: 110651492R	4	GPE 93
	2.3 dCi 125 FWD (JOVC, JOVD, JOVH)	2298	92	02.2011	OE: 110651492R	4	GPE 93
	2.3 dCi 135 FWD	2298	100	07.2014	OE: 110651492R	4	GPE 93
	2.3 dCi 145 FWD (JVOF, JVOH)	2298	107	02.2011	OE: 110651492R	4	GPE 93
	2.3 dCi 150 FWD	2298	110	10.2012	OE: 110651492R	4	GPE 93
MASTER III Camionnette (FV)	2.3 dCi 165 FWD	2298	120	07.2014	OE: 110651492R	4	GPE 93
	2.3 dCi 100 FWD (FVOA, FVOB, FVOG, FVOK)	2298	74	02.2010	OE: 110651492R	4	GPE 93
	2.3 dCi 100 RWD (FVOB, FVOC, FVOD)	2298	74	02.2010	OE: 110651492R	4	GPE 93
	2.3 dCi 110 FWD	2298	81	09.2014	OE: 110651492R	4	GPE 93
	2.3 dCi 125 FWD (FVOC, FVOD)	2298	92	02.2010	OE: 110651492R	4	GPE 93
	2.3 dCi 125 RWD (FVOC, FVOD, FVOH, FVOJ)	2298	92	02.2010	OE: 110651492R	4	GPE 93
	2.3 dCi 135 FWD	2298	100	07.2014	OE: 110651492R	4	GPE 93
	2.3 dCi 135 RWD	2298	100	07.2014	OE: 110651492R	4	GPE 93
	2.3 dCi 145 FWD (FVOE, FVOF, FVOH, FVOJ)	2298	107	02.2010	OE: 110651492R	4	GPE 93
	2.3 dCi 145 RWD (FVOE, FVOF, FVOJ)	2298	107	02.2010	OE: 110651492R	4	GPE 93
	2.3 dCi 150 FWD	2298	110	03.2013	OE: 110651492R	4	GPE 93
	2.3 dCi 150 RWD	2298	110	03.2013	OE: 110651492R	4	GPE 93
	2.3 dCi 165 FWD	2298	120	07.2014	OE: 110651492R	4	GPE 93
2.3 dCi 165 RWD	2298	120	07.2014	OE: 110651492R	4	GPE 93	
MASTER III Camion/Plate-forme (EV, HV, UV)	2.3 dCi 100 FWD (EVOA, EVOB, HVOA, HVOB, ...)	2298	74	02.2010	OE: 110651492R	4	GPE 93
	2.3 dCi 100 RWD (UVOC, UVOD, HVOC, HVOD)	2298	74	02.2010	OE: 110651492R	4	GPE 93
	2.3 dCi 110 FWD	2298	81	09.2014	OE: 110651492R	4	GPE 93
	2.3 dCi 125 FWD (EVOC, EVOD, EVOJ, HVOC, ...)	2298	92	02.2010	OE: 110651492R	4	GPE 93
	2.3 dCi 125 RWD (HVOC, HVOD, UVOC, UVOD)	2298	92	02.2010	OE: 110651492R	4	GPE 93
	2.3 dCi 135 RWD	2298	100	07.2014	OE: 110651492R	4	GPE 93





kW



Cyl.



RENAULT

	2.3 dCi 145 FWD (EVOE, EVOF, HVOE, HVOF, ..)	2298	107	02.2010		OE : 110651492R	4	GPE 93
	2.3 dCi 145 RWD (UVOF, UVOE)	2298	107	02.2010		OE : 110651492R	4	GPE 93
	2.3 dCi 150 FWD	2298	110	03.2013		OE : 110651492R	4	GPE 93
	2.3 dCi 150 RWD	2298	110	03.2013		OE : 110651492R	4	GPE 93
	2.3 dCi 165 RWD	2298	120	07.2014		OE : 110651492R	4	GPE 93
MEGANE III (BZ0/1_)	1.6 dCi (BZ00, BZ12)	1598	96	04.2011		R9M 402-404	4	GPE 93
MEGANE III Coupé (DZ0/1_)	1.6 dCi (DZ00)	1598	96	04.2011		R9M 402	4	GPE 93
MEGANE III Grandtour (KZ0/1_)	1.6 dCi (KZ00, KZ12)	1598	96	04.2011		R9M 402-404	4	GPE 93
MEGANE III CC (EZ0/1_)	1.6 dCi	1598	96	04.2011		R9M 402	4	GPE 93
MEGANE IV (B9A/M_)	1.6 dCi 130 (B9A4)	1598	96	11.2015		R9M 409	4	GPE 93
	1.6 dCi 165	1598	120	11.2015		R9M 452	4	GPE 93
MEGANE IV Grandtour (K9A/M_)	1.6 dCi 130	1598	96	04.2016		R9M 409	4	GPE 93
	1.6 dCi 165	1598	120	04.2016		R9M 452	4	GPE 93
SCÉNIC III (JZ0/1_)	1.6 dCi (JZ00, JZ12)	1598	96	04.2011		R9M 402-404-414	4	GPE 93
SCÉNIC IV (J9_)	1.6 dCi 130	1598	96	09.2016		R9M 409	4	GPE 93
	1.6 dCi 160	1598	118	09.2016		R9M 452	4	GPE 93
TALISMAN (L2M_)	1.6 dCi 130	1598	96	11.2015		R9M 409	4	GPE 93
	1.6 dCi 160	1598	118	06.2016		R9M 452 -453	4	GPE 93
TALISMAN Grandtour (KP_)	1.6 dCi 130	1598	96	03.2016		R9M 409	4	GPE 93
	1.6 dCi 160	1598	118	03.2016		R9M 452 -453	4	GPE 93
TRAFIC II Bus (JL)	2.0 dCi 90 (JLOH)	1995	66	08.2006		OE : 110651749R	4	GPE 93
	2.0 dCi 115 (JLOH)	1995	84	08.2006		OE : 110651749R	4	GPE 93
TRAFIC II Camionnette (FL)	2.0 dCi 90 (FLOH)	1995	66	08.2006		OE : 110651749R	4	GPE 93
	2.0 dCi 115 (FLO1, FLOU)	1995	84	08.2006		OE : 110651749R	4	GPE 93
TRAFIC II Camion/Plate-forme (EL)	2.0 dCi 90 (ELOH)	1995	66	08.2006		OE : 110651749R	4	GPE 93
	2.0 dCi 115 (ELOH)	1995	84	08.2006		OE : 110651749R	4	GPE 93
TRAFIC III Bus (JG_)	1.6 dCi 90	1598	66	05.2014		R9M 408	4	GPE 93
	1.6 dCi 95	1598	70	07.2015		R9M 413	4	GPE 93
	1.6 dCi 115	1598	85	05.2014		R9M 408	4	GPE 93
	1.6 dCi 120	1598	88	05.2014		R9M 450	4	GPE 93
	1.6 dCi 125	1598	92	07.2015		R9M 452	4	GPE 93
	1.6 dCi 140	1598	103	05.2014		R9M 450	4	GPE 93
	1.6 dCi 145	1598	107	07.2015		R9M 452	4	GPE 93
TRAFIC III Camion/Plate-forme (EG_)	1.6 dCi 120	1598	88	06.2014		R9M 450	4	GPE 93
	1.6 dCi 125	1598	92	07.2015		R9M 452	4	GPE 93
	1.6 dCi 140	1598	103	06.2014		R9M 450	4	GPE 93
	1.6 dCi 145	1598	107	07.2015		R9M 452	4	GPE 93
TRAFIC III Camionnette (FG_)	1.6 dCi 90	1598	66	05.2014		R9M 408	4	GPE 93
	1.6 dCi 95	1598	70	07.2015		R9M 413	4	GPE 93
	1.6 dCi 115	1598	85	05.2014		R9M 408	4	GPE 93
	1.6 dCi 120	1598	88	05.2014		R9M 450	4	GPE 93
	1.6 dCi 125	1598	92	07.2015		R9M 452	4	GPE 93
	1.6 dCi 140	1598	103	05.2014		R9M 450	4	GPE 93
	1.6 dCi 145	1598	107	07.2015		R9M 452	4	GPE 93

VAUXHALL

ZAFIRA Mk III (P12)	1.6 CDTi	1598	100	03.2013		B 16 DTH	2	GPE 94
---------------------	----------	------	-----	---------	--	----------	---	--------

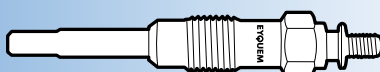

TECHNICAL CHARACTERISTICS CARACTÉRISTIQUES TECHNIQUES

TECHNISCHE INFORMATIONEN
CARACTERÍSTICAS TÉCNICAS

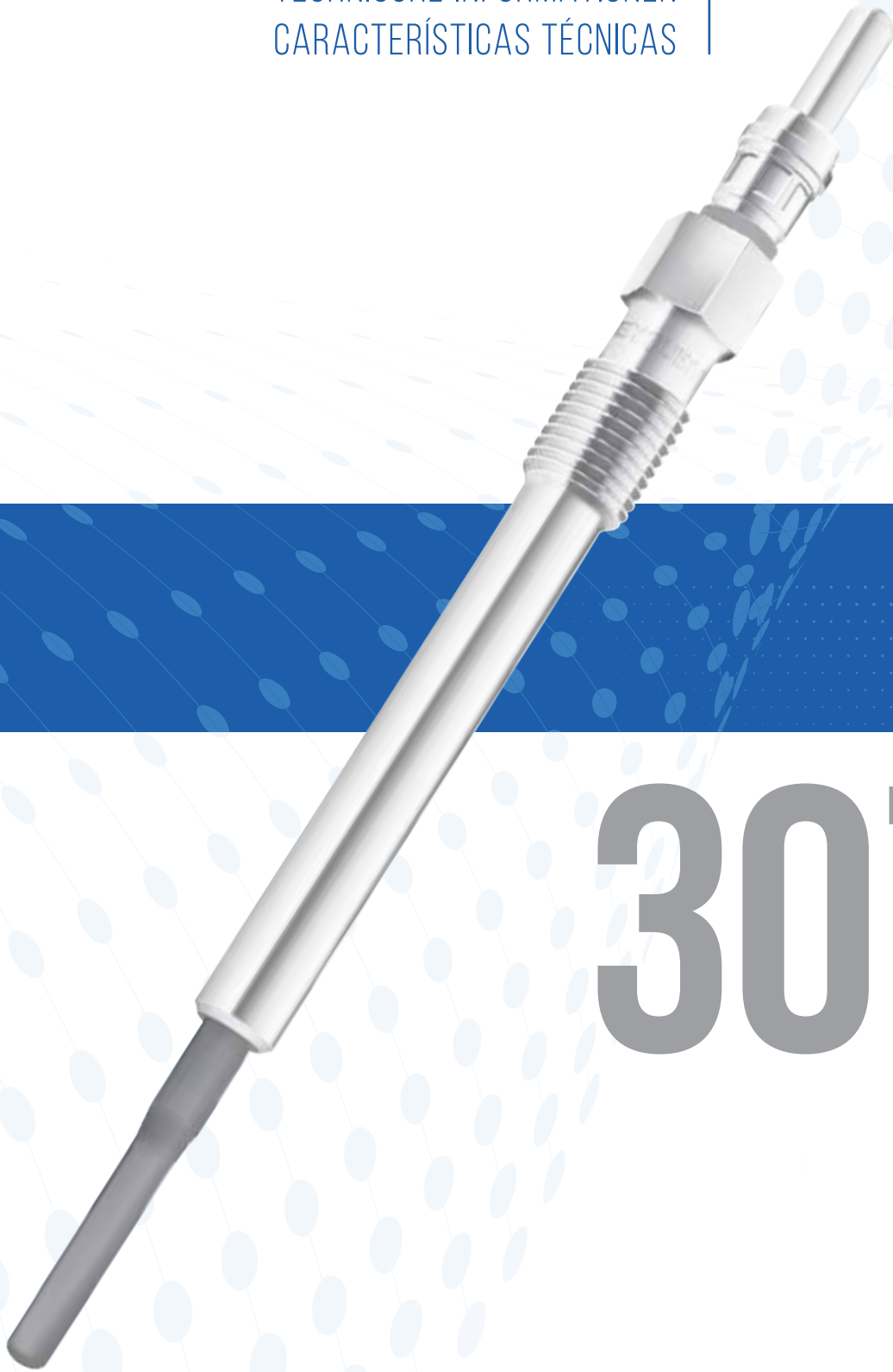

307

EYQUEM

EYQUEM	A	B	C	D	E	F	G	 Nm
G1	M 10X1,25	87,5	22	12	11	120°	G1	15
G2	M 12X1,25	76	30	12	11	63°	G1	22
G3	M 10X1	135	31	10	11	63°	G2	15
G4	M 10X1	92	30	10	12	63°	G2	15
G5	M 8X1	126,5	25	8	11	93°	G2	10
G6	M 8X1	118,5	28	8	11	123°	G1	10
G7	M 8X1,0	119,4	28	8	11	93°	G1	10
G8	M 9X1,0	151,5	30	9	11	93°	G1	10
G9	M 8X1,0	152	40	8	11	93°	G1	10
G10	M 10X1	80	25	10	11	63°	G1	15
G11	M 10X1,25	93	22,5	12	12	119°	G1	15
G12	M 10X1,25	87	22,5	12	7	119°	G1	15
G13	M 10X1	126	26,5	10	11,5	90°	G1	15
G14	M 10X1,25	102	28	12	7	93°	G1	15
G15	M 10X1,25	70,5	19	12	23	119°	G1	15
G16	M 10X1,25	95,5	32	12	7	93°	G1	15
G17	M 12X1,25	60	21	12	11	63°	G1	22
G18	M 10X1,25	95,5	32	12	11	93°	G1	15
G19	M 10X1	130	28	10	11,5	63°	G2	15
G20	M 10X1	125	35	10	11	63°	G2	15
G21	M 10X1	130	30,5	10	11,5	63°	G1	15
G22	M 10X1	120	40	10	11,5	63°	G2	15
G23	M 10X1	106	33	10	11	63°	G2	15
G24	M 12X1,25	69	23	12	11,5	63°	G1	22
G25	M 10X1	111,5	29,6	10	11	63°	G1	15
G26	M 10X1,25	160	36	10	11	93°	G1	15
G27	M 12X1,25	67	25	12	11	63°	G1	22
G28	M 10X1	87	25	10	11	63°	G2	15
G29	M 10X1	98	25	10	11	63°	G2	15
G30	M 10X1	118,4	27,75	10	11	63°	G1	15
G31	M 10X1,25	95	22	12	11	119°	G1	15
G32	M 10X1,25	88	23	12	11	119°	G1	15
G33	M 10X1,25	83	19	12	11	123°	G1	15
G34	M 10X1	89	30	10	11	63°	G1	15
G35	M 12X1,25	69	21	12	11	63°	G1	22
G36	M 10X1	84	25	10	11	63°	G1	15
G37	M 10X1	91	25	10	12	63°	G2	15
G38	M 10X1,25	94,5	18,5	12	11	123°	G1	15
G39	M 12X1,25	73	25	12	11	63°	G1	22
G40	M 10X1	96	30	10	11	63°	G2	15
G41	M 12X1,25	71	25	12	11	63°	G1	22
G42	M 12X1,25	63	18	12	10	63°	G1	22
G43	M 12X1,25	118,5	28	12	11,5	63°	G2	22
G44	M 10X1,25	83,5	19	12	11	123°	G1	15
G45	M 10X1,25	90	24	12	5	119°	G1	15
G46	M 10X1,25	86	19	12	5	119°	G1	15
G47	M 10X1,25	91	24	12	11	119°	G1	15
G48	M 10X1,25	86	19	12	11	119°	G1	15
G49	M 12X1,25	62	21	12	11	63°	G1	22
G50	M 12X1,25	69	26	12	11	63°	G1	22
G51	M 10X1	83	25	10	11	63°	G1	15
G52	M 10X1	126	29	10	11	63°	G1	15
G53	M 12X1,25	86,5	28	12	11,5	63°	G2	22
G54	M 10X1	94	25	10	11	63°	G1	15

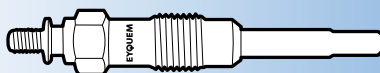

EYQUEM	A	B	C	D	E	F	G	 Nm
G55	M 10X1	120	34	10	11	93°	G1	15
G56	M 10X1	133	29	10	11	63°	G2	15
G57	M 10X1	107	28	10	11	63°	G1	15
G58	M 10X1	95	25	10	11	63°	G1	15
G59	M 12X1,25	76	21	12	11	63°	G2	22
G60	M 10X1	102,5	25	10	11	63°	G2	15
G61	M 12X1,25	114	28	12	11,5	63°	G2	22
G62	M 10X1	75	25	10	11	63°	G1	15
G63	M 10X1	151	25	10	11	63°	G2	15
G64	M 10X1,25	82	19	12	11	123°	G1	15
G65	M 10X1	147	35	10	11,5	93°	G1	15
G66	M 10X1	96	24,5	10	10	93°	G1	15
G67	M 10X1,25	85	19	12	11	119°	G2	15
G68	M 10X1,25	143	24	12	11	119°	G2	15
G69	M 10X1,25	85	18	12	11	123°	G1	15
GPE70	M 10X 1	97	30	10	5	63°	G2	15
GPE71	M 8X1	117	30	8	4,4	93°	G2	10
G72	M 8X1	124,5	28	8	11	123°	G2	10
GPE73	M 10x1,0	106,5	33	10	5	63°	G2	15
GPE74	M 10x1,0	130	28	10	4,4	63°	G2	15
G75	M 10x1,25	171	36,7	12	11	119°	G1	15
G76	M 10x1,0	179	20,8	12	11	119°	G1	15
G77	M 10x1,25	153,5	31	12	11	120°	G1	15
GPE78	M 10x1,0	96,5	24,5	10	4,4	63°	G2	15
GPE79	M 10x1,0	90,5	24,5	10	4,4	63°	G2	15
GPE80	M 9X1,0	119,5	28	9	4,4	93°	G2	12
GPE81	M 8X1	112,3	28	8	5	123°	G2	10
GPE82	M 9X1,0	156,5	35	9	4,4	93°	G2	12
GPE83	M 8X1	148,5	27	8	4,4	93°	G2	10
G84	M 10X1,25	96	27	12	11	93°	G1	15
G85	M 10X1,25	134,5	30,2	12	11	120°	G1	15
G86	M 10X1,25	160	28,3	10	11	93°	G1	15
G87	M 10x1,0	151	25	10	11	63°	G2	15
G88	M 8x1,0	97	28	8	11	123	G2	10
G89	M 10x1,0	108	30	10	11	63°	G2	12
GPE90	M 10x1,25	137,1	24	10	4,4	121°	G2	15
GPE91	M 10x1,0	134	29	10	4,4	63°	G2	15
GPE92	M 10x1,0	148,5	35,5	10	4,4	93°	G1	15
GPE93	M 10x1,0	162,7	26	10	4,6	93°	G2	15
GPE94	M 10x1,0	146	31,4	10	4,4	93°	G2	15

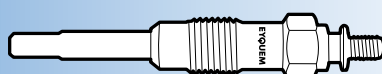

APPLICATIONS BY BRAND AND BY VEHICLE
APPLICATIONS PAR MARQUE
ET PAR VÉHICULE

VERWENDUNGEN NACH FAHRZEUGTYP
APLICACIONES POR MARCA Y VEHÍCULO



311

EYQUEM



kW



Cyl.



ALFA ROMEO

145 (930)		1.9 D	1929	68	07.1994	02.1999	AR 67501	4	G 41
		1.9 JTD	1910	77	02.1999	01.2001	AR 32302	4	G 60
		1.9 JTD	1910	77	02.1999	01.2001	AR 32302	4	G 58
		1.9 TD	1929	66	10.1994	02.1999	AR 33601/AR 67501	4	G 41
		1.9 D	1929	68	05.1995	09.1996	AR 67501	4	G 41
		1.9 JTD	1910	77	02.1999	01.2001	AR 32302	4	G 58
		1.9 TD	1929	66	12.1994	02.1999	AR 33601/AR 67501	4	G 41
147 (937)	NEW	1.9 JTD	1910	81	11.2000	09.2004	AR 37101	4	G 89
	NEW	1.9 JTDM	1910	85	10.2004	03.2010	939 A7.000	4	G 89
	NEW	1.9 JTDM 8V	1910	88	07.2005	03.2010	937 A3.000	4	G 89
		1.9 JTD	1910	74	06.2003		182 B9.000	4	G 60
		1.9 JTD (937AXD1A)	1910	85	04.2001		937 A2.000	4	G 60
		1.9 JTD 16V	1910	93	09.2003	09.2004	937 A4.000	4	G 8
		1.9 JTD 16V	1910	100	10.2004	03.2010	192 B1.000	4	G 8
		1.9 JTD 16V	1910	103	11.2002	03.2010	192 A5.000	4	G 8
		1.9 JTDM 16V	1910	110	09.2004	03.2010	937 A5.000	4	G 8
	155 (167)		1.9 TD (167.A3)	1929	66	04.1993	12.1997	AR 67501	4
		2.5 TD (167.A1A)	2499	92	04.1993	12.1997	VM 07 B/VM 31 B	4	G 40
		2.5 TD (167.A1A)	2499	92	04.1993	12.1997	VM 07 B/VM 31 B	4	G 41
156 (932)		1.9 JTD	1910	93	11.2003	09.2005	937 A4.000	4	G 8
		1.9 JTD	1910	100	11.2002	11.2004	192 B1.000	4	G 8
		1.9 JTD	1910	110	07.2004	09.2005	937 A5.000	4	G 8
		1.9 JTD (932A2B, 932A2C)	1910	85	05.2001	09.2005	937 A2.000	4	G 60
		1.9 JTD (932A2B_)	1910	81	10.2000	05.2001	AR 37101	4	G 60
		1.9 JTD (932B2)	1910	77	09.1997	10.2000	AR 32302	4	G 58
		1.9 JTD 16V	1910	103	11.2002	09.2005	192 A5.000	4	G 8
		2.4 JTD	2387	120	06.2003	09.2005	841 M.000	5	G 8
		2.4 JTD	2387	129	10.2003	09.2005	841 G.000	5	G 8
		2.4 JTD (932A1B_)	2387	103	10.2000	09.2005	839 A6.000	5	G 60
		2.4 JTD (932AXC)	2387	110	03.2002	09.2005	841 C000	5	G 60
		2.4 JTD (932B1)	2387	100	09.1997	10.2000	AR 32501	5	G 58
	156 Sportwagon (932)		1.9 JTD	1910	93	11.2003	05.2006	937 A4.000	4
		1.9 JTD	1910	100	11.2002	11.2004	192 B1.000	4	G 8
		1.9 JTD	1910	110	03.2005	05.2006	937 A5.000	4	G 8
		1.9 JTD (932B2)	1910	77	05.2000	10.2000	AR 32302	4	G 58
		1.9 JTD (932B2B, 932B2C)	1910	85	05.2001	05.2006	937 A2.000	4	G 60
		1.9 JTD (932B2B_)	1910	81	10.2000	05.2001	AR 37101	4	G 60
		1.9 JTD 16V	1910	103	11.2002	05.2006	192 A5.000	4	G 8
		1.9 JTD 16V Q4	1910	110	07.2004	05.2006	937 A5.000	4	G 8
		2.4 JTD	2387	129	10.2003	05.2006	841 G.000	5	G 60
		2.4 JTD	2387	120	06.2003	05.2006	841 M.000	5	G 8
		2.4 JTD (932B1)	2387	100	05.2000	10.2000	AR 32501	5	G 58
		2.4 JTD (932B1B_)	2387	103	10.2000	05.2006	839 A6.000	5	G 60
		2.4 JTD (932BXC)	2387	110	03.2002	05.2006	841 C000	5	G 60
159		1.9 JTDM 16V	1910	100	09.2005		939 A8.000/937 A8.000	4	G 8
		1.9 JTDM 16V	1910	110	09.2005		939 A2.000	4	G 8
159 (939)	NEW	1.9 JTDM 8V	1910	85	10.2006	12.2008	937 A7.000/939 A7.000	4	G 89
	NEW	1.9 JTDM 8V	1910	88	09.2005	11.2011	939 A1.000	4	G 89
	NEW	2.0 JTDM	1956	100	06.2010	11.2011	939 B4.000	4	GPE 82
	NEW	2.0 JTDM	1956	120	05.2009	11.2011	844 A2.000	4	GPE 82
	NEW	2.0 JTDM	1956	125	05.2009	11.2011	939 B3.000	4	GPE 82
		2.4 JTDM	2387	147	09.2005	11.2011	939 A3.000	5	G 8
		2.4 JTDM	2387	154	05.2007	11.2011	939 A9.000	5	G 8
159 Sportwagon		1.9 JTDM 16V	1910	100	03.2006		937 A8.000	4	G 8
		1.9 JTDM 16V	1910	110	03.2006		939 A2.000	4	G 8
159 Sportwagon (939)		1.9 JTDM 8V	1910	85	03.2006	09.2006	937 A7.000	4	G 60
	NEW	1.9 JTDM 8V	1910	85	10.2006	12.2008	937 A7.000	4	G 89
	NEW	1.9 JTDM 8V	1910	88	03.2006	11.2011	939 A1.000	4	G 89
	NEW	2.0 JTDM	1956	100	06.2010	11.2011	939 B4.000	4	GPE 82
	NEW	2.0 JTDM	1956	120	05.2009	11.2011	844 A2.000	4	GPE 82
	NEW	2.0 JTDM	1956	125	05.2009	11.2011	939 B3.000	4	GPE 82
		2.4 JTDM	2387	147	03.2006	11.2011	939 A3.000	5	G 8
	2.4 JTDM	2387	154	05.2007	11.2011	939 A9.000	5	G 8	
164 (164)		2.5 TD (164.A1A)	2499	84	06.1987	09.1992	VM 84 A	4	G 2
		2.5 TD (164.K2A, 164.K2B)	2499	92	09.1992	09.1998	VM 32 B/VM 08 B	4	G 40

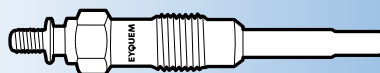



kW



Cyl.

**ALFA ROMEO**

	2.5 TD (164.K2A, 164.K2B)	2499	92	09.1992	09.1998	VM 32 B/VM 08 B	4	G 41
166 (936)	2.4 JTD	2387	110	04.2002		841 C000	5	G 60
	2.4 JTD	2387	129	10.2003		841 G.000/841 H.000	5	G 8
	2.4 JTD	2387	136	07.2005		936 B.000/841 M.000	5	G 8
	2.4 JTD	2387	132	07.2006		841 M.000	5	G 8
	2.4 JTD (936A2A_)	2387	100	09.1998	10.2000	AR 34202	5	G 58
	2.4 JTD (936A2B_)	2387	103	10.2000		839 A6.000	5	G 60
33 (905)	1.8 TD	1779	54	01.1986	06.1990	VM 82 A	3	G 2
33 (907A)	1.8 TD (907A5)	1779	62	07.1990	09.1994	VM 96 A	3	G 2
33 Sportwagon (905A)	1.8 TD	1779	62	01.1986	12.1989	VM 96 A	3	G 2
6 (119)	2.5 TD	2494	77	07.1981	05.1986	VM-HR 588 HT	5	G 2
75 (162B)	2.0 TD (162.BD, 162.BG)	1995	70	05.1985	09.1992	VM 80 A	4	G 2
	2.4 TD	2393	82	01.1989	02.1992	VM 81 A	4	G 2
90 (162)	2.4 TD (162.B5)	2393	81	10.1984	07.1987	VM 81 A	4	G 2
ALFETTA (116)	2.0 TD (116.BA)	1995	60	10.1979	03.1983	VM4HT/2	4	G 2
	2.4 TD (116.B3)	2393	70	04.1983	12.1984	VM4HT 2.4	4	G 2
AR 6 Bus (280)	1.9 D	1929	51	04.1985	12.1989	160 D100	4	G 41
	2.4 D	2445	53	04.1985	02.1986	8144.61.200	4	G 41
AR 8 Camionnette (280)	2.4 D	2445	53	04.1978	08.1986	8140.61.200	4	G 41
	2.5 D	2499	55	09.1986	12.1989	8144.67.220	4	G 41
BRERA	2.4 JTDM 20V	2387	147	01.2006		939 A3.000	5	G 8
	NEW 2.0 JTDM	1956	120	03.2008		844 A2.000	4	GPE 82
	NEW 2.0 JTDM	1956	125	05.2009		939 B3.000	4	GPE 82
GIULIA	1.8 D	1760	38	06.1976	12.1978	4.108	4	G 2
GIULIETTA (116)	2.0 TD	1995	61	01.1983	12.1985	VM 4 HT	4	G 2
GIULETTA (940)	NEW 1.6 JTDM	1598	77	04.2010		940 A3.000	4	GPE 82
	NEW 2.0 JTDM	1956	100	04.2010		940 A8.000/940 B6.000	4	GPE 82
	NEW 2.0 JTDM	1956	103	04.2010		940 A5.000	4	GPE 82
	NEW 2.0 JTDM	1956	110	08.2013		940 B5.000	4	GPE 82
	NEW 2.0 JTDM	1956	120	04.2010		940 A7.000	4	GPE 82
	NEW 2.0 JTDM	1956	125	04.2010		940 A4.000	4	GPE 82
	NEW 2.0 JTDM	1956	129	11.2013		940 B4.000	4	GPE 82
GT 937)	1.9 JTD	1910	110	11.2003	09.2010	937 A5.000	4	G 8
MITO (955)	NEW 1.3 JTDM	1248	59	12.2013		199 B8.000	4	GPE 80
	NEW 1.3 JTDM	1248	62	01.2011		199 B4.000	4	GPE 80
	1.3 JTDM	1248	66	09.2008		199 A3.000	4	G 7
	NEW 1.3 JTDM	1248	70	10.2009		199 B1.000	4	GPE 80
	NEW 1.6 JTDM	1598	85	09.2008		955 A4.000	4	GPE 82
	NEW 1.6 JTDM	1598	88	09.2008		198 A2.000/955 A3.000	4	GPE 82
SPIDER (939)	NEW 2.0 JTDM	1956	120	04.2009		844 A2.000	4	GPE 82
	NEW 2.0 JTDM	1956	125	05.2009		939 B3.000	4	GPE 82
	2.4 JTDM	2387	147	04.2007		939 A3.000	5	G 8
	2.4 JTDM	2387	154	03.2008		939 A3.000	5	G 8

ARO

240-244	2.5 D	2498	52	01.1983		XD3P	4	G 41
	2.5 TD	2498	70	01.1992		XD3TP	4	G 41
	2.5 TD	2500	74	01.1992		VM-425HLT	4	G 41
	2.7 D	2660	52	04.1985		Aro L-27D	4	G 41
	2.7 D	2660	50	09.1989			4	G 41
	2.7 D	2660	60	01.1983		Aro L-27D	4	G 41

AUDI

100 (43, C2)	2.0 D	1986	51	08.1978	07.1982	CN	5	G 17
100 (44, 44Q, C3)	2.0 D	1986	51	08.1982	07.1988	CN	5	G 17
	2.0 D Turbo	1986	64	08.1982	02.1988	DE	5	G 17
	2.0 D Turbo	1986	74	03.1988	11.1990	NC	5	G 17
	2.4 D	2370	60	08.1989	07.1991	3D	5	G 17
	2.5 TDI	2461	88	01.1990	11.1990	1T	5	G 37
100 (4A, C4)	2.4 D	2370	60	12.1990	06.1994	AAS	5	G 17
	2.5 TDI	2461	85	12.1990	06.1994	AAT/ABP	5	G 37
100 Avant (43, C2)	2.0 D	1986	51	08.1978	02.1983	CN	5	G 17
100 Avant (44, 44Q, C3)	2.0 D	1986	51	03.1983	11.1990	CN	5	G 17
	2.0 TD	1986	64	03.1983	10.1987	DE	5	G 17
	2.0 TD	1986	74	03.1988	11.1990	NC	5	G 17





kW



Cyl.



AUDI									
		2.4 D	2370	60	08.1989	11.1990	3D	5	G 17
		2.5 TDI	2461	88	01.1990	11.1990	1T	5	G 37
100 Avant (4A, C4)		2.4 D	2370	60	12.1990	06.1994	AAS	5	G 17
		2.5 TDI	2461	85	12.1990	06.1994	AAT/ABP	5	G 37
80 (81, 85, B2)		1.6 D	1588	40	08.1980	08.1986	JK/CR	4	G 17
		1.6 TD	1588	51	08.1981	05.1986	CY	4	G 17
80 (89, 89Q, 8A, B3)		1.6 D	1588	40	09.1986	08.1991	JK	4	G 17
		1.6 TD	1588	59	09.1986	08.1991	RA/SB	4	G 17
		1.9 D	1896	50	08.1989	08.1991	1Y	4	G 17
80 (8C, B4)		1.9 TD	1896	55	09.1991	12.1994	AAZ	4	G 17
		1.9 TDI	1896	66	09.1991	12.1994	1Z	4	G 17
		1.9 TDI	1896	66	09.1991	12.1994	1Z	4	G 37
80 Avant (8C, B4)		1.9 TD	1896	55	09.1991	12.1994	AAZ	4	G 17
		1.9 TDI	1896	66	07.1992	01.1996	1Z	4	G 17
90 (81, 85, B2)		1.6 TD	1588	51	10.1985	01.1987	CY	4	G 17
90 (89, 89Q, 8A, B3)		1.6 TD	1588	59	04.1987	09.1991	RA/SB	4	G 17
A1 (8X1)	NEW	1.4 TDI	1422	66	11.2014		CUSB	3	GPE 74
		1.6 TDI	1598	66	03.2011		CAYB	4	GPE 74
		1.6 TDI	1598	77	05.2010		CAYC	4	GPE 74
	NEW	1.6 TDI	1598	85	11.2014		CXMA	4	GPE 74
		2.0 TDI	1968	105	09.2011		CFHD	4	GPE 74
A1 Sportback (8XA)	NEW	1.4 TDI	1422	66	11.2014		CUSB	3	GPE 74
	NEW	1.6 TDI	1598	66	11.2011		CAYB	4	GPE 74
	NEW	1.6 TDI	1598	77	11.2011		CAYC	4	GPE 74
	NEW	1.6 TDI	1598	85	11.2014		CXMA	4	GPE 74
	NEW	2.0 TDI	1968	105	09.2011		CFHD	4	GPE 74
A2 (8Z0)		1.2 TDI	1191	45	03.2001	08.2005	ANY	3	G 4
		1.4 TDI	1422	66	11.2003	08.2005	ATL	3	GPE 70
		1.4 TDI	1422	55	02.2000	08.2005	AMF/BHC	3	G 4
A3 (8L1)		1.9 TDI	1896	66	09.1996	07.2001	AGR/ALH	4	G 37
		1.9 TDI	1896	74	10.2000	05.2003	AXR/ATD	4	G 17
		1.9 TDI	1896	81	08.1997	07.2001	AHF/ASV	4	G 17
		1.9 TDI	1896	96	08.2000	05.2003	ASZ	4	G 4
		1.9 TDI	1896	96	08.2000	05.2003	ASZ	4	G 17
		1.9 TDI	1896	96	08.2000	05.2003	ASZ	4	G 37
		1.9 TDI	1896	66	09.1996	07.2001	AGR/ALH	4	G 37
		1.9 TDI	1896	74	10.2000		AXR/ATD	4	G 37
		1.9 TDI	1896	81	08.1997	07.2001	AHF/ASV	4	G 37
		1.9 TDI	1896	66	09.1996	07.2001	AGR/ALH	4	G 17
		1.9 TDI quattro	1896	96	08.2000		ASZ	4	G 4
		1.9 TDI quattro	1896	96	08.2000		ASZ	4	G 17
		1.9 TDI quattro	1896	96	08.2000		ASZ	4	G 37
		1.9 TDI quattro	1896	96	08.2000		ASZ	4	G 17
A3 (8P1)		1.6 TDI	1598	66	05.2009	08.2012	CAYB	4	GPE 74
		1.6 TDI	1598	77	05.2009	08.2012	CAYC	4	GPE 74
		1.9 TDI	1896	77	05.2003	05.2010	BXE/BKG/BLS	4	GPE 70
		2.0 TDI	1968	100	05.2003	08.2012	CBAA/CFFA/AZV	4	GPE 71
		2.0 TDI	1968	100	05.2003	08.2012	CBAA/CFFA/AZV	4	GPE 74
		2.0 TDI quattro	1968	100	05.2003	06.2008	AZV	4	GPE 71
		2.0 TDI	1968	103	06.2005	06.2008	BMM	4	GPE 70
		2.0 TDI quattro	1968	103	01.2006	06.2008	BMM	4	GPE 70
		2.0 TDI 16V	1968	103	05.2003	08.2012	CFFB/CLJA/CBAB/BKD	4	GPE 71
		2.0 TDI 16V	1968	103	05.2003	08.2012	CFFB/CLJA/CBAB/BKD	4	GPE 74
		2.0 TDI 16V	1968	103	05.2003	08.2012	CFFB/CLJA/CBAB/BKD	4	GPE 71
		2.0 TDI 16V quattro	1968	103	08.2004	08.2012	CFFB/CBAB/BKD	4	GPE 71
		2.0 TDI 16V quattro	1968	103	08.2004	08.2012	CFFB/CBAB/BKD	4	GPE 74
		2.0 TDI 16V quattro	1968	103	08.2004	08.2012	CFFB/CBAB/BKD	4	GPE 71
		2.0 TDI quattro	1968	125	03.2006	08.2012	BMN/CFGB/CBBB	4	GPE 74
A3 (8V1)	NEW	1.6 TDI	1598	77	10.2012		CLHA	4	GPE 74
	NEW	1.6 TDI	1598	81	09.2013		CRKB/CXXB/DBKA	4	GPE 74
	NEW	2.0 TDI	1968	81	01.2013		CRFA	4	GPE 74
	NEW	2.0 TDI	1968	100	05.2013		CRBD/CRLC	4	GPE 74
	NEW	2.0 TDI	1968	105	09.2012		CRFC	4	GPE 74
	NEW	2.0 TDI	1968	110	04.2012		CRBC/CRLB/CRUA	4	GPE 74
	NEW	2.0 TDI quattro	1968	110	10.2012		CRBC	4	GPE 74

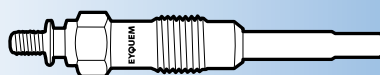



kW



Cyl.



AUDI

	NEW	2.0 TDI	1968	135	05.2013		CUNA	4	GPE 74
	NEW	2.0 TDI quattro	1968	135	12.2012		CUNA	4	GPE 74
A3 Cabriolet (8P7)		1.6 TDI	1598	77	05.2009	05.2013	CAYC	4	GPE 74
		1.9 TDI	1896	77	04.2008	10.2009	BLS	4	GPE 70
		2.0 TDI	1968	100	04.2008	05.2013	CBAA/CFFA	4	GPE 74
		2.0 TDI	1968	103	04.2008	05.2013	CFFB/CBAB	4	GPE 74
A3 Cabriolet (8V7)	NEW	1.6 TDI	1598	81	02.2014		CRKB/CXXB	4	GPE 74
	NEW	2.0 TDI	1968	100	10.2013		CRLC	4	GPE 74
	NEW	2.0 TDI	1968	110	10.2013		CRLB	4	GPE 74
	NEW	2.0 TDI quattro	1968	110	03.2014		CRLB	4	GPE 74
	NEW	2.0 TDI	1968	135	05.2014		CUNA	4	GPE 74
	NEW	2.0 TDI	1968	135	05.2014		CUNA	4	GPE 74
A3 Limousine (8VS)	NEW	1.6 TDI	1598	77	09.2013		CLHA	4	GPE 74
	NEW	1.6 TDI	1598	81	05.2014		CRKB/CXXB/DBKA	4	GPE 74
	NEW	2.0 TDI	1968	81	05.2013		CRFA	4	GPE 74
	NEW	2.0 TDI	1968	100	09.2013		CRBD/CRLC	4	GPE 74
	NEW	2.0 TDI	1968	105	10.2013		CRFC	4	GPE 74
	NEW	2.0 TDI	1968	110	05.2013		CRBC/CRLB/CRUA	4	GPE 74
	NEW	2.0 TDI quattro	1968	110	10.2013		CRBC/CRLB	4	GPE 74
	NEW	2.0 TDI	1968	135	05.2014		CUNA	4	GPE 74
	NEW	2.0 TDI quattro	1968	135	05.2014		CUNA	4	GPE 74
A3 Sportback (8PA)		1.6 TDI	1598	66	05.2009	03.2013	CAYB	4	GPE 74
		1.6 TDI	1598	77	05.2009	03.2013	CAYC	4	GPE 74
		1.9 TDI	1896	77	09.2004	05.2010	BXE/BKC/BLS	4	GPE 70
		2.0 TDI	1968	100	09.2004	03.2013	AZV	4	GPE 71
		2.0 TDI	1968	100	09.2004	03.2013	CBAA/CFFA	4	GPE 74
		2.0 TDI	1968	103	06.2005	06.2008	BMM	4	GPE 70
		2.0 TDI quattro	1968	103	01.2006	06.2008	BMM	4	GPE 70
		2.0 TDI 16V	1968	103	09.2004	03.2013	CFFB/CLJA/CBAB	4	GPE 74
		2.0 TDI 16V	1968	103	09.2004	03.2013	BKD	4	GPE 71
		2.0 TDI 16V quattro	1968	103	11.2005	03.2013	BKD	4	GPE 71
		2.0 TDI 16V quattro	1968	103	11.2005	03.2013	CFFB/CBAB	4	GPE 74
		2.0 TDI 16V quattro	1968	103	11.2005	03.2013	BKD	4	GPE 71
		2.0 TDI	1968	125	03.2006	03.2013	CFGB/CBBB	4	GPE 74
		2.0 TDI quattro	1968	125	03.2006	03.2013	CFGB/CBBB	4	GPE 74
A3 Sportback (8VA)	NEW	1.6 TDI	1598	77	10.2012		CLHA	4	GPE 74
	NEW	1.6 TDI	1598	81	09.2013		CRKB/CXXB/DBKA	4	GPE 74
	NEW	2.0 TDI	1968	81	05.2013		CRFA	4	GPE 74
	NEW	2.0 TDI	1968	100	05.2013		CRBD/CRLC	4	GPE 74
	NEW	2.0 TDI	1968	105	05.2013		CRFC	4	GPE 74
	NEW	2.0 TDI	1968	110	09.2012		CRLB/CRBC	4	GPE 74
	NEW	2.0 TDI quattro	1968	110	02.2013		CRLB/CRBC	4	GPE 74
	NEW	2.0 TDI quattro	1968	135	05.2013		CUNA	4	GPE 74
A4 (8D2, B5)		1.9 TDI	1896	55	12.1995	11.2000	AFF	4	G 17
		1.9 TDI	1896	66	01.1995	11.2000	1Z/AHU/AHH	4	G 17
		1.9 TDI	1896	81	10.1995	11.2000	AVG/AFN	4	G 17
		1.9 TDI	1896	85	03.2000	11.2000	AJM	4	G 17
		1.9 TDI	1896	55	12.1995	11.2000	AFF	4	G 37
		1.9 TDI	1896	66	01.1995	11.2000	1Z/AHU/AHH	4	G 37
		1.9 TDI	1896	81	10.1995	11.2000	AVG/AFN	4	G 37
		1.9 TDI	1896	85	03.2000	11.2000	AJM	4	G 37
		1.9 TDI quattro	1896	81	09.1996	11.2000	AVG/AFN	4	G 17
		1.9 TDI quattro	1896	85	03.2000	11.2000	ATJ/AJM	4	G 17
		1.9 TDI quattro	1896	81	09.1996	11.2000	AVG/AFN	4	G 37
		1.9 TDI quattro	1896	85	03.2000	11.2000	ATJ/AJM	4	G 37
		2.5 TDI	2496	110	09.1997	11.2000	AFB/AKN	6	G 20
		2.5 TDI quattro	2496	110	09.1997	11.2000	AFB/AKN	6	G 20
A4 (8E2, B6)		1.9 TDI	1896	85	06.2004	12.2004	BKE	4	GPE 70
		1.9 TDI	1896	96	11.2000	12.2004	AWX/AVF	4	G 4
		1.9 TDI	1896	96	11.2000	12.2004	AWX/AVF	4	G 17
		1.9 TDI	1896	96	11.2000	12.2004	AWX/AVF	4	G 37
		1.9 TDI	1896	74	05.2001	12.2004	AVB	4	G 37
		1.9 TDI quattro	1896	96	11.2001	12.2004	AVF	4	G 4
		1.9 TDI quattro	1896	96	11.2001	12.2004	AVF	4	G 17
		1.9 TDI quattro	1896	96	11.2001	12.2004	AVF	4	G 37

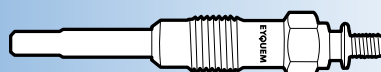



kW



Cyl.



AUDI

	2.5 D	2496	132	10.2000	05.2003	AKE	6	G 20
	2.5 TDI	2496	114	08.2001	07.2002	AYM	6	G 20
	2.5 TDI	2496	120	07.2002	12.2004	BCZ/BDG/BFC	6	G 20
	2.5 TDI quattro	2496	132	11.2000	12.2004	BAU/AKE/BDH	6	G 20
A4 (8EC, B7)	1.9 TDI	1896	85	11.2004	06.2008	BKE	4	GPE 70
	2.0 TDI	1968	100	11.2004	06.2008	BNA	4	GPE 71
	2.0 TDI 16V	1968	103	11.2004	06.2008	BLB	4	GPE 71
	2.5 TDI	2496	120	11.2004	05.2006	BDG	6	G 20
	2.7 TDI	2698	120	11.2005	06.2008	BSG	6	GPE 74
	2.7 TDI	2698	132	01.2006	06.2008	BPP	6	GPE 74
	3.0 TDI quattro	2967	150	11.2004	06.2008	BKN	6	GPE 74
	3.0 TDI quattro	2967	171	01.2006	06.2008	ASB	6	GPE 74
A4 (8K2, B8)	2.0 TDI	1968	88	06.2008		CAGC/CJCC	4	GPE 74
	2.0 TDI	1968	100	11.2007		CAGB/CJCB/CSUB	4	GPE 74
	2.0 TDI	1968	105	11.2007		CAGA/CJCA/CMEA/CMFA	4	GPE 74
	NEW 2.0 TDI quattro	1968	105	11.2008		CAGA/CJCA	4	GPE 74
	NEW 2.0 TDI quattro	1968	110	05.2013		CJCD/CMFB/CSUA	4	GPE 74
	2.0 TDI	1968	120	08.2008		CAHB/CGLD/CNHC	4	GPE 74
	2.0 TDI quattro	1968	125	01.2008		CAHA	4	GPE 74
	2.0 TDI quattro	1968	130	11.2011		CGLC/CMGB	4	GPE 74
	NEW 2.0 TDI quattro	1968	140	09.2013		CNHA	4	GPE 74
	2.7 TDI	2698	120	11.2007		CAMB/CGKB	6	GPE 74
	2.7 TDI	2698	140	11.2007		CGKA/CAMA	6	GPE 74
	3.0 TDI quattro	2967	150	11.2011		CLAB	6	GPE 74
	3.0 TDI quattro	2967	155	06.2008		CCWB	6	GPE 74
	3.0 TDI quattro	2967	176	11.2007		CAPA/CCWA/CCLA	6	GPE 74
	3.0 TDI quattro	2967	180	11.2011		CDUC/CKVB/CKVC	6	GPE 74
A4 (8W2, B9)	NEW 2.0 TDI	1968	100	05.2015		DEUB	4	GPE 74
	NEW 2.0 TDI	1968	110	05.2015		CZHA/DEUA	4	GPE 74
	NEW 3.0 TDI quattro	2967	160	09.2015		CSWB	6	GPE 74
A4 Allroad (8KH, B8)	2.0 TDI quattro	1968	100	09.2009		CAGB/CJCB	4	GPE 74
	2.0 TDI quattro	1968	105	09.2009		CAGA/CJCA	4	GPE 74
	NEW 2.0 TDI quattro	1968	110	05.2013		CJCD	4	GPE 74
	2.0 TDI quattro	1968	120	04.2009		CAHB/CGLD	4	GPE 74
	2.0 TDI quattro	1968	125	04.2009		CAHA	4	GPE 74
	2.0 TDI quattro	1968	130	11.2011		CGLC	4	GPE 74
	NEW 2.0 TDI quattro	1968	140	09.2013		CNHA	4	GPE 74
	3.0 TDI quattro	2967	176	04.2009		CCWA	6	GPE 74
	3.0 TDI quattro	2967	180	01.2012		CDUC/CKVB/CKVC	6	GPE 74
A4 Avant (8D5, B5)	1.9 DUO	1896	66	03.1998	09.2001	AHU	4	G 37
	1.9 DUO	1896	66	03.1998	09.2001	AHU	4	G 17
	1.9 TDI	1896	55	03.1996	09.2001	AFF	4	G 17
	1.9 TDI	1896	66	02.1996	09.2001	1Z/AHU/AHH	4	G 17
	1.9 TDI	1896	81	02.1996	09.2001	AVG/AFN	4	G 17
	1.9 TDI	1896	85	03.2000	09.2001	AJM	4	G 17
	1.9 TDI	1896	66	02.1996	09.2001	1Z/AHU/AHH	4	G 37
	1.9 TDI	1896	81	02.1996	09.2001	AVG/AFN	4	G 37
	1.9 TDI	1896	55	03.1996	09.2001	AFF	4	G 37
	1.9 TDI	1896	85	03.2000	09.2001	AJM	4	G 37
	1.9 TDI quattro	1896	81	09.1996	09.2001	AVG/AFN	4	G 17
	1.9 TDI quattro	1896	85	03.2000	09.2001	ATJ/AJM	4	G 17
	1.9 TDI quattro	1896	81	09.1996	09.2001	AVG/AFN	4	G 37
	1.9 TDI quattro	1896	85	03.2000	09.2001	ATJ/AJM	4	G 37
	2.5 TDI	2496	110	09.1997	09.2001	AFB/AKN	6	G 20
	2.5 TDI quattro	2496	110	09.1997	09.2001	AFB/AKN	6	G 20
A4 Avant (8E5, B6)	1.9 TDI	1896	85	06.2004	12.2004	BKE	4	GPE 70
	1.9 TDI	1896	96	09.2001	12.2004	AWX/AVF	4	G 4
	1.9 TDI	1896	96	09.2001	12.2004	AWX/AVF	4	G 17
	1.9 TDI	1896	96	09.2001	12.2004	AWX/AVF	4	G 37
	1.9 TDI	1896	74	11.2001	12.2004	AVB	4	G 37
	1.9 TDI quattro	1896	96	11.2001	12.2004	AVF	4	G 4
	1.9 TDI quattro	1896	96	11.2001	12.2004	AVF	4	G 17
	1.9 TDI quattro	1896	96	11.2001	12.2004	AVF	4	G 37
	2.5 TDI	2496	132	10.2000	05.2003	AKE	6	G 20
	2.5 TDI	2496	114	09.2001	07.2002	AYM	6	G 20





kW



Cyl.



AUDI

	2.5 TDI	2496	120	07.2002	12.2004	BCZ/BDG/BFC	6	G 20
	2.5 TDI quattro	2496	132	09.2001	12.2004	BAU/AKE/BDH	6	G 20
A4 Avant (8ED, B7)	1.9 TDI	1896	85	11.2004	06.2008	BKE	4	GPE 70
	2.0 TDI	1968	100	11.2004	06.2008	BNA	4	GPE 71
	2.0 TDI 16V	1968	103	11.2004	06.2008	BLB	4	GPE 71
	2.5 TDI	2496	120	11.2004	05.2006	BDG	6	G 20
	2.7 TDI	2698	120	11.2005	03.2008	BSG	6	GPE 74
	2.7 TDI	2698	132	01.2006	06.2008	BPP	6	GPE 74
	3.0 TDI quattro	2967	150	11.2004	06.2008	BKN	6	GPE 74
	3.0 TDI quattro	2967	171	01.2006	06.2008	ASB	6	GPE 74
A4 Avant (8K5, B8)	2.0 TDI	1968	88	06.2008		CAGC/CJCC	4	GPE 74
	2.0 TDI	1968	100	04.2008		CAGB/CJCB/CSUB	4	GPE 74
	2.0 TDI quattro	1968	105	04.2008		CAGA/CJCA/CMEA/CMFA	4	GPE 74
	NEW 2.0 TDI quattro	1968	110	05.2013		CJCD/CMFB/CSUA	4	GPE 74
	2.0 TDI	1968	120	08.2008		CAHB	4	GPE 74
	2.0 TDI quattro	1968	125	04.2008		CAHA	4	GPE 74
	2.0 TDI quattro	1968	130	11.2011		CGLC	4	GPE 74
	NEW 2.0 TDI quattro	1968	140	09.2013		CNHA	4	GPE 74
	2.7 TDI	2698	120	06.2008		CAMB/CGKB	6	GPE 74
	2.7 TDI	2698	140	04.2008		CGKA/CAMA	6	GPE 74
	3.0 TDI	2698	150	11.2011		CLAB	6	GPE 74
	3.0 TDI quattro	2967	155	06.2008		CCWB	6	GPE 74
	3.0 TDI quattro	2967	176	04.2008		CAPA/CCWA/CCLA	6	GPE 74
	NEW 3.0 TDI quattro	2967	180	11.2011		CDUC/CKVB/CKVC	6	GPE 74
A4 Avant (8W5, B9)	NEW 2.0 TDI quattro	1968	100	08.2015		DEUB	4	GPE 74
	NEW 2.0 TDI quattro	1968	110	08.2015		CZHA/DEUA	4	GPE 74
	NEW 3.0 TDI quattro	2967	160	10.2015		CSWB	6	GPE 74
A4 Cabriolet (8H7, B6 8HE, B7)	2.5 TDI	2496	120	08.2002	12.2005	BCZ/BDG/BFC	6	G 20
	2.7 TDI	2698	132	06.2006	03.2009	BPP	6	GPE 74
	3.0 TDI quattro	2967	150	01.2006	03.2009	BKN	6	GPE 74
	3.0 TDI quattro	2967	171	01.2006	03.2009	ASB	6	GPE 74
A5 (8T3)	2.0 TDI	1968	120	08.2008		CAHB	4	GPE 74
	2.0 TDI quattro	1968	125	08.2008		CAHA	4	GPE 74
	2.0 TDI quattro	1968	130	10.2011		CGLC	4	GPE 74
	NEW 2.0 TDI quattro	1968	140	09.2013		CNHA	4	GPE 74
	2.7 TDI	2698	120	09.2007		CAMB/CGKB	6	GPE 74
	2.7 TDI	2698	140	06.2007		CGKA/CAMA	6	GPE 74
	3.0 TDI	2967	150	10.2011		CLAB	6	GPE 74
	3.0 TDI quattro	2967	155	03.2008		CCWB	6	GPE 74
	NEW 3.0 TDI quattro	2967	160	05.2015		CKVD	6	GPE 74
	3.0 TDI quattro	2967	176	06.2007		CAPA/CCWA	6	GPE 74
	3.0 TDI quattro	2967	180	10.2011		CDUC/CKVB	6	GPE 74
A5 Cabriolet (8F7)	NEW 2.0 TDI	1968	105	10.2011		CJCA	4	GPE 74
	NEW 2.0 TDI	1968	110	05.2013		CJCD	4	GPE 74
	2.0 TDI	1968	120	05.2009		CAHB	4	GPE 74
	2.0 TDI	1968	125	05.2009		CAHA	4	GPE 74
	2.0 TDI	1968	130	10.2011		CGLC	4	GPE 74
	2.0 TDI quattro	1968	130	01.2012		CGLC	4	GPE 74
	NEW 2.0 TDI quattro	1968	140	09.2013		CNHA	4	GPE 74
	2.7 TDI	2698	120	05.2009		CGKB	6	GPE 74
	2.7 TDI	2698	140	03.2009		CGKA	6	GPE 74
	3.0 TDI	2967	150	10.2011		CLAB	6	GPE 74
	NEW 3.0 TDI quattro	2967	160	05.2015		CKVD	6	GPE 74
	3.0 TDI quattro	2967	176	03.2009		CCWA	6	GPE 74
	3.0 TDI quattro	2967	180	10.2011		CDUC/CKVC	6	GPE 74
A5 Sportback (8TA)	NEW 2.0 TDI	1968	100	09.2009		CAGB/CJCB	4	GPE 74
	2.0 TDI	1968	105	09.2009		CAGA/CJCA/CMEA/CMFA	4	GPE 74
	2.0 TDI	1968	100	09.2009		CAGB	4	GPE 74
	NEW 2.0 TDI	1968	110	05.2013		CJCD	4	GPE 74
	2.0 TDI	1968	120	09.2009		CAHB/CGLD	4	GPE 74
	2.0 TDI quattro	1968	125	09.2009		CAHA	4	GPE 74
	2.0 TDI	1968	130	10.2011		CGLC	4	GPE 74
	2.0 TDI quattro	1968	130	12.2011		CGLC	4	GPE 74
	NEW 2.0 TDI quattro	1968	140	09.2013		CNHA	4	GPE 74
	2.7 TDI	2698	120	09.2009		CGKB	6	GPE 74

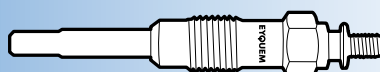



kW



Cyl.



AUDI

	2.7 TDI	2698	140	09.2009		CGKA	6	GPE 74
	3.0 TDI	2967	150	10.2011		CLAB	6	GPE 74
	NEW 3.0 TDI quattro	2967	160	05.2015		CKVD	6	GPE 74
	3.0 TDI quattro	2967	176	09.2009		CCWA	6	GPE 74
	3.0 TDI quattro	2967	180	10.2011		CDUC/CKVB	6	GPE 74
A6 (4A, C4)	1.9 TDI	1896	66	06.1994	10.1997	1Z/AHU	4	G 17
	1.9 TDI	1896	66	06.1994	10.1997	1Z/AHU	4	G 37
	2.5 TDI	2461	84	01.1995	10.1997	AAT	5	G 37
	2.5 TDI	2461	85	06.1994	10.1997	AAT	5	G 37
	2.5 TDI	2461	103	08.1994	10.1997	AEL	5	G 37
	2.5 TDI quattro	2461	103	10.1995	10.1997	AEL	5	G 37
A6 (4B, C5)	1.9 TDI	1896	81	04.1997	10.2000	AVG/AFN	4	G 17
	1.9 TDI	1896	85	07.2000	01.2005	AJM	4	G 17
	1.9 TDI	1896	96	08.2001	01.2005	AWX/AVF	4	G 17
	1.9 TDI	1896	96	08.2001	01.2005	AWX/AVF	4	G 4
	1.9 TDI	1896	81	04.1997	10.2000	AVG/AFN	4	G 37
	1.9 TDI	1896	85	07.2000	01.2005	AJM	4	G 37
	2.5 TDI	2496	110	07.1997	01.2005	AFB/AKN	6	G 20
	2.5 TDI	2496	132	02.2000	01.2005	BAU/AKE/BND/BDH	6	G 20
	2.5 TDI	2496	132	02.2000	01.2005	BAU/AKE/BND/BDH	6	G 20
	2.5 TDI	2496	132	02.2000	01.2005	BAU/AKE/BND/BDH	6	G 20
	2.5 TDI	2496	114	08.2001	01.2005	AYM	6	G 20
	2.5 TDI	2496	120	07.2002	01.2005	BCZ/BDG/BFC	6	G 20
	2.5 TDI quattro	2496	110	07.1997	01.2005	AFB/AKN	6	G 20
	2.5 TDI quattro	2496	132	02.2000	01.2005	BAU/AKE/BDH	6	G 20
A6 (4F2, C6)	2.0 TDI	1968	100	07.2004	03.2011	BNA	4	GPE 71
	2.0 TDI	1968	100	07.2004	03.2011	CAGB	4	GPE 74
	2.0 TDI	1968	103	07.2004	10.2008	BLB/BRE	4	GPE 71
	2.0 TDI	1968	120	04.2009		CAHB	4	GPE 74
	2.0 TDI	1968	125	11.2008	03.2011	CAHA	4	GPE 74
	2.7 TDI quattro	2698	120	11.2004	03.2011	CANB/BSG	6	GPE 74
	2.7 TDI quattro	2698	120	06.2005	03.2011	CAND/BSG	6	GPE 74
	2.7 TDI quattro	2698	132	11.2004	10.2008	BPP	6	GPE 74
	2.7 TDI	2698	140	10.2008	03.2011	CANA	6	GPE 74
	2.7 TDI quattro	2698	120	06.2005		CAND/BSG	6	GPE 74
	2.7 TDI quattro	2698	140	10.2008	03.2011	CANC	6	GPE 74
	3.0 TDI	2967	171	06.2006		ASB	6	GPE 74
	3.0 TDI quattro	2967	155	05.2004	03.2011	BNG/CDYB	6	GPE 74
	3.0 TDI quattro	2967	165	05.2004	05.2006	BMK	6	GPE 74
	3.0 TDI quattro	2967	171	06.2006	10.2008	ASB	6	GPE 74
	3.0 TDI quattro	2967	176	10.2008	03.2011	CDYA/CDYC	6	GPE 74
A6 (4G2, C7, 4GC)	NEW 2.0 TDI	1968	110	09.2014		CSUD	4	GPE 74
	2.0 TDI	1968	120	03.2011		CGLD	4	GPE 74
	2.0 TDI	1968	130	03.2011		CGLC/CMGB	4	GPE 74
	NEW 2.0 TDI	1968	140	11.2013		CNHA	4	GPE 74
	NEW 2.0 TDI quattro	1968	140	04.2015		CNHA	4	GPE 74
	3.0 TDI	2967	150	11.2010		CLAB	6	GPE 74
	3.0 TDI quattro	2967	150	03.2011		CLAA	6	GPE 74
	NEW 3.0 TDI quattro	2967	155	09.2014		CTCB	6	GPE 74
	NEW 3.0 TDI quattro	2967	160	09.2014		CTCC	6	GPE 74
	NEW 3.0 TDI quattro	2967	176	05.2013		CPNB	6	GPE 74
	3.0 TDI quattro	2967	180	03.2011		CDUC/CDUD/CKVB/CKVC	6	GPE 74
	NEW 3.0 TDI quattro	2967	200	09.2014		CRTD	6	GPE 74
	NEW 3.0 TDI quattro	2967	230	11.2011		CGQB	6	GPE 74
	NEW 3.0 TDI quattro	2967	235	09.2014		CVUA	6	GPE 74
	NEW 3.0 TDI quattro	2967	240	09.2014		CVUB	6	GPE 74
A6 Allroad (4FH, C6)	2.7 TDI quattro	2698	120	05.2006	08.2011	CAND/BSG	6	GPE 74
	2.7 TDI quattro	2698	132	05.2006	10.2008	BPP	6	GPE 74
	2.7 TDI quattro	2698	140	10.2008	08.2011	CANC	6	GPE 74
	3.0 TDI quattro	2967	155	05.2006	08.2011	BNG/CDYB	6	GPE 74
	3.0 TDI quattro	2967	171	05.2006	10.2008	ASB	6	GPE 74
	3.0 TDI quattro	2967	176	10.2008	08.2011	CDYA	6	GPE 74
A6 Allroad (4GH, 4GJ)	NEW 3.0 TDI quattro	2967	150	01.2012		CLAA	6	GPE 74
	NEW 3.0 TDI quattro	2967	140	11.2015		CZVF	6	GPE 74
	NEW 3.0 TDI quattro	2967	155	09.2014		CRTF	6	GPE 74





kW



Cyl.



AUDI

	NEW	3.0 TDI quattro	2967	160	09.2014		CRTE	6	GPE 74
	NEW	3.0 TDI quattro	2967	180	01.2012		CDUD/CKVC	6	GPE 74
	NEW	3.0 TDI quattro	2967	200	09.2014		CRTD	6	GPE 74
	NEW	3.0 TDI quattro	2967	230	01.2012		CGQB	6	GPE 74
	NEW	3.0 TDI quattro	2967	235	01.2012		CVUA	6	GPE 74
A6 Avant (4A, C4)		1.9 TDI	1896	66	06.1994	12.1997	1Z/AHU	4	G 17
		1.9 TDI	1896	66	06.1994	12.1997	1Z/AHU	4	G 37
		2.5 TDI	2461	84	01.1995	12.1997	AAT	5	G 37
		2.5 TDI	2461	85	06.1994	12.1997	AAT	5	G 37
		2.5 TDI	2461	103	08.1994	12.1997	AEL	5	G 37
		2.5 TDI quattro	2461	103	07.1995	12.1997	AEL	5	G 37
A6 Avant (4B, C5)		1.9 TDI	1896	81	02.1998	04.2001	AFN	4	G 17
		1.9 TDI	1896	85	07.2000	01.2005	AJM	4	G 17
		1.9 TDI	1896	96	08.2001	01.2005	AWX/AVF	4	G 4
		1.9 TDI	1896	81	02.1998	04.2001	AFN	4	G 37
		1.9 TDI	1896	85	07.2000	01.2005	AJM	4	G 37
		2.5 TDI	2496	110	12.1997	01.2005	AFB/AKN	6	G 20
		2.5 TDI	2496	114	08.2001	01.2005	AYM	6	G 20
		2.5 TDI	2496	120	07.2002	01.2005	BCZ/BDG/BFC	6	G 20
		2.5 TDI	2496	132	02.2000	01.2005	BAU/AKE/BDH	6	G 20
		2.5 TDI quattro	2496	110	12.1997	01.2005	AFB/AKN	6	G 20
		2.5 TDI quattro	2496	132	02.2000	01.2005	BAU/AKE/BDH	6	G 20
A6 Avant (4F5, C6)		2.0 TDI	1968	100	06.2005	08.2011	BNA	4	GPE 71
		2.0 TDI	1968	100	06.2005	08.2011	CAGB	4	GPE 74
		2.0 TDI	1968	103	06.2005	10.2008	BLB	4	GPE 71
		2.0 TDI	1968	103	06.2005	10.2008	BRE	4	G 4
		2.0 TDI quattro	1968	120	04.2009	08.2011	CAHB	4	GPE 74
		2.0 TDI	1968	125	10.2008	08.2011	CAHA	4	GPE 74
		2.7 TDI quattro	2698	120	03.2005	08.2011	CANB/BSG	6	GPE 74
		2.7 TDI quattro	2698	132	03.2005	10.2008	BPP	6	GPE 74
		2.7 TDI quattro	2698	140	10.2008	08.2011	CANA	6	GPE 74
		2.7 TDI quattro	2698	140	10.2008	08.2011	CANC	6	GPE 74
		3.0 TDI quattro	2967	155	03.2005	08.2011	BNG/CDYB	6	GPE 74
		3.0 TDI quattro	2967	165	03.2005	05.2006	BMK	6	GPE 74
		3.0 TDI quattro	2967	171	06.2006	10.2008	ASB	6	GPE 74
		3.0 TDI quattro	2967	176	10.2008	08.2011	CDYA/CDYC	6	GPE 74
A6 Avant (4G5, C7, 4GD)	NEW	2.0 TDI	1968	110	09.2014		CSUD	4	GPE 74
	NEW	2.0 TDI	1968	120	05.2011		CGLD	4	GPE 74
	NEW	2.0 TDI	1968	130	05.2011		CGLC/CMGB	4	GPE 74
	NEW	2.0 TDI	1968	140	11.2013		CNHA	4	GPE 74
	NEW	2.0 TDI quattro	1968	140	04.2015		CNHA	4	GPE 74
	NEW	3.0 TDI quattro	2967	150	05.2011		CLAB	6	GPE 74
	NEW	3.0 TDI quattro	2967	155	09.2014		CTCB/CRTF	6	GPE 74
	NEW	3.0 TDI quattro	2967	160	09.2014		CTCC/CRTE	6	GPE 74
	NEW	3.0 TDI quattro	2967	180	05.2011		CDUC/CDUD/CKVB/CKVC	6	GPE 74
	NEW	3.0 TDI quattro	2967	200	09.2014		CRTD	6	GPE 74
	NEW	3.0 TDI quattro	2967	230	11.2011		CGQB	6	GPE 74
	NEW	3.0 TDI quattro	2967	235	09.2014		CVUA	6	GPE 74
	NEW	3.0 TDI quattro	2967	240	09.2014		CVUB	6	GPE 74
		2.0 TDI	1968	130	05.2011		CGLC/CMGB	4	GPE 74
A6 Avant (4G5, C7)		2.0 TDI	1968	120	05.2011		CGLD	4	GPE 74
		3.0 TDI	2967	150	05.2011		CLAB	6	GPE 74
		3.0 TDI quattro	2967	230	11.2011		CGQB	6	GPE 74
		3.0 TDI quattro	2967	180	05.2011		CDUC/CDUD/CKVB/CKVC	6	GPE 74
		3.0 TDI quattro	2967	150	05.2011		CLAA	6	GPE 74
A7 Sportback (4GA, 4GF)	NEW	3.0 TDI quattro	2967	140	11.2015		CZVE/CZVF	6	GPE 74
		3.0 TDI	2967	150	11.2010		CLAB/CLAA	6	GPE 74
	NEW	3.0 TDI quattro	2967	155	11.2015		CZVD	6	GPE 74
	NEW	3.0 TDI quattro	2967	155	07.2014		CRTF/CTCB	6	GPE 74
	NEW	3.0 TDI quattro	2967	160	07.2014		CTCC/CRTE	6	GPE 74
	NEW	3.0 TDI quattro	2967	176	05.2013		CPNB	6	GPE 74
	NEW	3.0 TDI quattro	2967	180	10.2010		CDUC/CDUD/CKVB/CKVC	6	GPE 74
	NEW	3.0 TDI quattro	2967	200	05.2014		CRTD	6	GPE 74
		3.0 TDI quattro	2967	230	11.2011		CGQB	6	GPE 74
	NEW	3.0 TDI quattro	2967	235	05.2014		CVUA	6	GPE 74





kW



Cyl.



AUDI									
	NEW	3.0 TDI quattro	2967	240	05.2014		CVUB	6	GPE 74
A7 Sportback (4GA)		3.0 TDI quattro	2967	150	12.2010		CLAA	6	GPE 74
		3.0 TDI quattro	2967	180	10.2010		CDUC/CDUD/CKVB/CKVC	6	GPE 74
A8 (4D2, 4D8)		2.5 TDI	2496	110	01.1997	04.2000	AFB/AKN	6	G 20
		2.5 TDI	2496	132	09.2000	09.2002	AKE	6	G 20
		2.5 TDI quattro	2496	110	07.1997	04.2000	AFB/AKN	6	G 20
		2.5 TDI quattro	2496	132	09.2000	09.2002	AKE	6	G 20
		3.3 TDI quattro	3328	165	06.2000	09.2002	AKF	8	G 20
A8 (4E_)		3.0 TDI quattro	2967	155	11.2003	07.2010	BNG	6	GPE 74
		3.0 TDI quattro	2967	171	08.2003	07.2010	ASB	6	GPE 74
		4.0 TDI quattro	3936	202	03.2003	07.2005	ASE	8	G 20
		4.2 TDI quattro	4134	235	01.2005	06.2005	BMC	8	GPE 74
		4.2 TDI quattro	4134	240	07.2005	07.2010	BVN	8	GPE 74
A8 (4H_)		3.0 TDI	2967	150	09.2011		CLAB	6	GPE 74
		3.0 TDI quattro	2967	155	08.2010		CDTB/CTBB	6	GPE 74
	NEW	3.0 TDI quattro	2967	176	11.2012		CPNA	6	GPE 74
		3.0 TDI quattro	2967	184	07.2010		CMHA/CDTA	6	GPE 74
	NEW	3.0 TDI quattro	2967	190	10.2013		CTBA	6	GPE 74
	NEW	3.0 TDI quattro	2967	193	05.2015		CTBD	6	GPE 74
		4.2 TDI quattro	4134	258	11.2009		CDSB	8	GPE 74
	NEW	4.2 TDI quattro	4134	283	10.2013		CTEC	8	GPE 74
ALLROAD (4BH)		2.5 TDI quattro	2496	120	05.2003	08.2005	BCZ	6	G 20
		2.5 TDI quattro	2496	132	05.2000	08.2005	BAU/AKE	6	G 20
CABRIOLET (8G7, B4)		1.9 TDI	1896	66	06.1995	08.2000	1Z/AHU	4	G 17
		1.9 TDI	1896	66	06.1995	08.2000	1Z/AHU	4	G 37
Q3 (8U)		2.0 TDI	1968	100	09.2011		CFFA	4	GPE 74
		2.0 TDI	1968	103	09.2011		CFFB	4	GPE 74
		2.0 TDI quattro	1968	103	01.2012		CFFB	4	GPE 74
		2.0 TDI quattro	1968	130	06.2011		CFGC/CLLB	4	GPE 74
	NEW	2.0 TDI quattro	1968	135	11.2014		CUWA/CYLA	4	GPE 74
Q5 (8R)		2.0 TDI quattro	1968	100	08.2009		CAGB	4	GPE 74
	NEW	2.0 TDI	1968	100	11.2010		CJCB/CSUB	4	GPE 74
		2.0 TDI quattro	1968	105	08.2009		CJCA/CAGA	4	GPE 74
	NEW	2.0 TDI	1968	105	11.2010		CJCA	4	GPE 74
	NEW	2.0 TDI quattro	1968	110	05.2013		CJCD/CSUA	4	GPE 74
		2.0 TDI quattro	1968	120	11.2008		CGLA/CAHB	4	GPE 74
		2.0 TDI quattro	1968	125	11.2008		CAHA/CGLB/CMGA	4	GPE 74
	NEW	2.0 TDI quattro	1968	130	06.2012		CGLC/CMGB	4	GPE 74
	NEW	2.0 TDI	1968	140	09.2015		CNHA	4	GPE 74
	NEW	2.0 TDI quattro	1968	140	11.2013		CNHA	4	GPE 74
		3.0 TDI	2967	155	11.2008		CCWB	6	GPE 74
		3.0 TDI quattro	2967	176	11.2008		CCWA	6	GPE 74
	NEW	3.0 TDI quattro	2967	180	06.2012		CDUD	6	GPE 74
	NEW	3.0 TDI quattro	2967	184	06.2012		CTBC	6	GPE 74
	NEW	3.0 TDI quattro	2967	190	11.2013		CTBA	6	GPE 74
	NEW	SQ5 TDI quattro	2967	230	12.2012		CGQB/CVUC	6	GPE 74
	NEW	SQ5 TDI quattro	2967	240	04.2015		CVUB	6	GPE 74
	NEW	SQ5 TDI quattro	2967	250	11.2015		DEHA	6	GPE 74
Q7 (4L)		3.0 TDI	2967	150	05.2010	08.2015	CJMA/CJGC	6	GPE 74
		3.0 TDI	2967	155	03.2006	05.2010	CASB/BUN	6	GPE 74
		3.0 TDI	2967	165	03.2006	05.2012	CATA	6	GPE 74
		3.0 TDI	2967	171	03.2006	05.2008	BUG	6	GPE 74
		3.0 TDI	2967	176	11.2007	08.2015	CASA/CJGA/CCMA	6	GPE 74
		3.0 TDI	2967	180	05.2011	08.2015	CJGD/CLZB/CRCA	6	GPE 74
		4.2 TDI	4134	240	03.2007	06.2009	BTR	8	GPE 74
		4.2 TDI	4134	250	05.2009	08.2015	CCFA/CCFC	8	GPE 74
		6.0 TDI	5934	368	09.2008	05.2014	CCGA	12	GPE 74
Q7 (4M)	NEW	3.0 TDI	2967	183	06.2015		CVMD	6	GPE 74
	NEW	3.0 TDI	2967	190	08.2015		CUEA	6	GPE 74
	NEW	3.0 TDI	2967	200	06.2015		CRTC	6	GPE 74
TT (8J3)		2.0 TDI quattro	1968	125	06.2008	06.2014	CFGB/CBBB	4	GPE 74
TT (FV3)	NEW	2.0 TDI	1968	135	07.2014		CUNA	4	GPE 74
TT Roadster (8J9)		2.0 TDI quattro	1968	125	06.2008	06.2014	CFGB/CBBB	4	GPE 74
TT Roadster (FV9)	NEW	2.0 TDI	1968	135	11.2014		CUNA	4	GPE 74





kW



Cyl.

**BEDFORD**

ASTRA VAN Kombi	1.6 D	1598	40	07.1982	08.1984	16 D	4	G 41
	1.6 D	1598	40	09.1985	08.1988	16 D	4	G 41
ASTRAMAX Kombi	1.6 D	1598	40	09.1985	08.1988	16 D	4	G 41
BLITZ (CF97)	2.0 D	1998	44	10.1980	10.1983	20 DTr	4	G 41
	2.0 D	1998	44	10.1980	10.1983	20 DTr	4	G 41
	2.0 D	1998	44	10.1980	10.1983	20 DTr	4	G 41
	2.1 D	2068	44	09.1981	10.1987	21D	4	G 35
	2.1 D	2068	44	09.1981	10.1987	21D	4	G 35
	2.3 D	2260	46	01.1973	10.1987	23D	4	G 41
	2.3 D	2260	46	01.1973	10.1987	23D	4	G 41
	2.3 D	2260	46	01.1973	10.1987	23D	4	G 41
	2.3 D	2260	46	01.1973	10.1987	23D	4	G 41
MIDI Camionnette	2.2 D	2189	45	06.1988	08.1992	22DIE	4	G 46
	2.2 D	2189	45	06.1988	08.1992	22DIE	4	G 48
	2.2 D 4WD	2189	45	06.1988	08.1992	22DIE	4	G 46
	2.2 D 4WD	2189	45	06.1988	08.1992	22DIE	4	G 48

BERTONE

FREECLIMBER	2.4 TD	2443	85	06.1989	12.1993	BMW M 21 D 24	6	G 41
-------------	--------	------	----	---------	---------	---------------	---	------

BMW

1 (E87)	NEW 118 d	1995	90	11.2003	09.2012	M47 D20 (204D4)	4	GPE 73
	NEW 118 d	1995	100	11.2003	09.2012	M47 D20 (204D4)	4	GPE 73
	NEW 118 d	1995	105	11.2003	09.2012	M47 D20 (204D4)	4	GPE 73
	NEW 120 d	1995	120	09.2004	09.2012	M47 D20 (204D4)	4	GPE 73
	NEW 120 d	1995	130	11.2003	09.2012	M47D 20 A/B/C	4	GPE 73
1 (F20)	NEW 114 d	1496	70	06.2015		B37 D15 A	2	GPE 91
	NEW 116 d	1496	85	03.2015		B37 D15 A	2	GPE 91
	NEW 116 d	1598	85	11.2012		N47 D16 A	2	GPE 91
	NEW 116 d	1995	85	12.2010		N47 D20 C	2	GPE 91
1 (F21)	NEW 114 d	1496	70	06.2015		B37 D15 A	2	GPE 91
	NEW 116 d	1496	85	03.2015		B37 D15 A	2	GPE 91
	NEW 116 d	1598	85	12.2011		N47 D16 A	2	GPE 91
	NEW 116 d	1995	85	01.2012		N47 D20 C	2	GPE 91
2 Active Tourer (F45)	NEW 214 d	1496	70	07.2014	02.2018	B37 C15 A	2	GPE 91
	NEW 216 d	1496	85	03.2014		B37 C15 A	2	GPE 91
2 Gran Tourer (F46)	NEW 214 d	1496	70	07.2015	02.2018	B37 C15 A	2	GPE 91
	NEW 216 d	1496	85	08.2014		B37 C15 A	2	GPE 91
3 (E30)	324 d	2443	63	09.1985	08.1991	M21 D24 (246DA)	6	G 41
	324 td	2443	85	09.1987	06.1993	M21 D24 (246TB)	6	G 41
3 (E36)	318 tds	1665	66	01.1995	02.1998	M41 D18 (Inter.)	4	G 41
	325 td	2497	85	09.1991	02.1998	M51 D25	6	G 41
	325 tds	2503	105	05.1993	02.1998	M51 D25 (Inter.)	6	G 41
3 (E46)	NEW 318 d	1951	85	09.2001	03.2003	M47 N	4	GPE 73
	318 d	1951	85	09.2001	03.2003	M47 D20 (204D1)	4	G 23
	NEW 318 d	1951	85	03.2003	02.2005	M47 D20 (204D4)	4	GPE 73
	320 d	1951	100	04.1998	09.2001	M47 D20 (204D1)	4	G 23
	NEW 320 d	1995	110	09.2001	02.2005	M47 D20 (204D4)	4	GPE 73
	330 d	2926	135	10.1999	02.2005	M57 D30 (306D1)	6	G 23
	NEW 330 d	2993	150	03.2003	02.2005	M57 D30 (306D2)	6	GPE 73
	330 xd	2926	135	06.2000	02.2005	M57 D30 (306D1)	6	G 23
	NEW 330 xd	2926	150	03.2003	02.2005	M57 D30 (306D2)	6	GPE 73
3 (E90)	318 d	1995	90	09.2005	12.2011	M47 D20 (204D4)	4	GPE 73
	320 d	1995	110	09.2005	12.2011	M47 D20 (204D4)	4	GPE 73
	320 d	1995	120	01.2005	12.2011	M47 D20 (204D4) - N47 D20 C	4	GPE 73
	325 d	2993	145	09.2006	12.2011	M57 D30 (306D3)	6	GPE 73
	330 d, xd	2993	170	09.2005	12.2011	M57 D30 (306D3)	6	GPE 73
	335 d	2993	210	09.2006	12.2011	M57 D30 (306D5)	6	GPE 73
3 Cabriolet (E46)	320 Cd	1995	110	02.2005	12.2007	M47 D20 (204D4)	4	GPE 73
	330 Cd	2993	150	08.2005	12.2007	M57 D30 (306D2)	6	GPE 73
3 Cabriolet (E93)	NEW 325 d	2993	145	03.2007	12.2010	M57 D30 (306D3)	6	GPE 73
	NEW 330 d	2993	170	03.2007	12.2013	M57 D30 (306D3)	6	GPE 73
3 Compact (E36)	318 tds	1665	66	01.1995	08.2000	M41 D17 (174T1)	4	G 41
3 Compact (E46)	318 td	1995	85	03.2003	02.2005	M47 D20 (204D4)	4	GPE 73
	320 td	1995	110	09.2001	02.2005	M47 D20 (204D4)	4	GPE 73

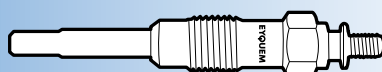



kW



Cyl.



BMW									
3 Coupe (E46)	NEW	320 Cd	1995	110	11.2003	07.2006	M47 D20 (204D4)	4	GPE 73
		330 Cd	2993	150	03.2003	07.2006	M57 D30 (306D2)	6	GPE 73
3 Coupe (E92)		325 d	2993	145	03.2007	12.2013	M57 D30 (306D3)	6	GPE 73
	NEW	325 d	2993	155	01.2007	12.2009	M57 D30 (306D3)	6	GPE 73
		330 d, xd	2993	170	09.2006	12.2013	M57 D30 (306D3)	6	GPE 73
		335 d	2993	210	09.2006	12.2013	M57 D30 (306D5)	6	GPE 73
3 Touring (E30)		324 td	2443	85	01.1988	06.1993	M21 D24 (246TB)	6	G 41
3 Touring (E36)		318 tds	1665	66	01.1995	10.1999	M41 D17 (174T1)	4	G 41
		325 tds	2503	105	01.1995	10.1999	M51 D25 (256T1)	6	G 41
3 Touring (E46)		318 d	1951	85	03.2002	02.2005	M47 D20 (204D1)	4	G 23
	NEW	318 d	1951	85	03.2003	02.2005	M47 D20 (204D4)	4	GPE 73
		320 d	1951	100	03.2000	09.2001	M47 D20 (204D1)	4	G 23
	NEW	320 d	1995	110	09.2001	02.2005	M47 D20 (204D4)	4	GPE 73
		330 d	2926	135	10.1999	02.2005	M57 D30 (306D1)	6	G 23
	NEW	330 d	2993	150	03.2003	02.2005	M57 D30 (306D2)	6	GPE 73
		330 xd	2926	135	06.2000	02.2005	M57 D30 (306D1)	6	G 23
		330 xd	2993	150	03.2003	02.2005	M57 D30 (306D2)	6	GPE 73
3 Touring (E91)		318 d	1995	90	09.2005	06.2012	M47 D20 (204D4)	4	GPE 73
		320 d	1995	110	09.2005	06.2012	M47 D20 (204D4)	4	GPE 73
		320 d	1995	120	09.2005	06.2012	N47 D20C - M47 D20 (204D4)	4	GPE 73
		325 d	2993	145	09.2006	06.2012	M57 D30 (306D3)	6	GPE 73
		330 d	2993	170	09.2005	06.2012	M57 D30 (306D3)	6	GPE 73
		330 xd	2993	170	09.2005	06.2012	M57 D30 (306D3)	6	GPE 73
		335 d	2993	210	09.2006	06.2012	M57 D30 (306D5)	6	GPE 73
5 (E28)		524 d	2443	63	03.1986	12.1987	M21 D24 (246DA)	6	G 41
		524 td	2443	85	09.1983	12.1987	M21 D24 (246TA)	6	G 41
5 (E34)		524 td	2443	85	03.1988	09.1995	M21 D24/M21 D24 WA	6	G 41
		525 td	2497	85	04.1993	09.1995	M51 D25 (256T1)	6	G 41
		525 tds	2503	105	09.1991	09.1995	M51 D25 (256T1)	6	G 41
5 (E39)		520 d	1951	100	02.2000	06.2003	M47 D20 (204D1)	4	G 23
		525 d	2497	120	02.2000	06.2003	M57 D25 (256D1)	6	G 23
		525 td	2497	85	01.1997	06.2003	M51 D25 (256T1)	6	G 41
		525 tds	2503	105	01.1996	06.2003	M51 D25 (256T1)	6	G 41
		530 d	2926	135	08.1998	09.2000	M57 D30 (306D1)	6	G 23
		530 d	2926	142	09.2000	06.2003	M57 D30 (306D1)	6	G 23
5 (E60)		520 d	1995	110	09.2005	03.2010	M47 D20 (204D4)	4	GPE 73
		520 d	1995	120	07.2005	03.2010	M47 D20 (204D4)	4	GPE 73
		525 d	2497	120	12.2004	03.2010	M57 D25 (256D1)	6	GPE 73
		525 d	2497	130	06.2004	03.2010	M57 D25 (256D2)	6	GPE 73
		525 d	2993	145	01.2007	03.2010	M57 D30 (306D3)	6	GPE 73
		525 d xDrive	2993	145	09.2008	03.2010	M57 D30 (306D3)	6	GPE 73
		525 xd	2993	145	01.2007	03.2010	M57 D30 (306D3)	6	GPE 73
		530 d	2993	155	07.2003	03.2010	M57 D30 (306D2-306D3)	6	GPE 73
		530 d	2993	160	07.2003	03.2010	M57 D30 (306D2)	6	GPE 73
		530 d	2993	170	07.2003	03.2010	M57 D30 (306D3)	6	GPE 73
		530 d	2993	173	01.2007	03.2010	M57 D30 (306D3)	6	GPE 73
		530 d xd	2993	173	09.2008	03.2010	M57 D30 (306D3)	6	GPE 73
		530 xd	2993	170	07.2005	03.2010	M57 D30 (306D3)	6	GPE 73
		530 xd	2993	173	01.2007	03.2010	M57 D30 (306D3)	6	GPE 73
5 Touring (E34)		535 d	2993	200	09.2004	03.2010	M57 D30 (306D4)	6	GPE 73
		535 d	2993	210	01.2007	03.2010	M57 D30 (306D5)	6	GPE 73
		525 td	2497	85	03.1993	01.1997	M51 D25 (256T1)	6	G 41
5 Touring (E39)		525 tds	2503	105	12.1991	01.1997	M51 D25 (256T1)	6	G 41
		520 d	1951	100	02.2000	09.2003	M47 D20 (204D1)	4	G 23
5 Touring (E61)		525 d	2497	120	02.2000	05.2004	M57 D25 (256D1)	6	G 23
		525 tds	2503	105	03.1997	05.2004	M51 D25 (256T1)	6	G 41
		530 d	2926	135	08.1998	09.2000	M57 D30 (306D1)	6	G 23
		530 d	2926	142	09.2000	05.2004	M57 D30 (306D1)	6	G 23
		520 d	1995	110	09.2005	12.2010	M47 D20 (204D4)	4	GPE 73
5 Touring (E61)		520 d	1995	120	07.2005	12.2010	M47 D20 (204D4)	4	GPE 73
		525 d	2497	120	12.2004	12.2010	M57N 256 D4	6	GPE 73
		525 d	2497	130	06.2004	12.2010	M57 D25 (256D2)	6	GPE 73
		525 d	2993	145	01.2007	12.2010	M57 D30 (306D3)	6	GPE 73
		525 xd	2993	145	01.2007	12.2010	M57 D30 (306D3)	6	GPE 73
		525 d xDrive	2993	145	09.2008	12.2010	M57 D30 (306D3)	6	GPE 73

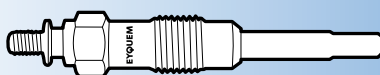



kW



Cyl.

**BMW**

	530 d	2993	160	06.2004	12.2010	M57 D30 (306D2)	6	GPE 73
	530 d	2993	170	07.2005	12.2010	M57 D30 (306D3)	6	GPE 73
	530 d	2993	173	01.2007	12.2010	M57 D30 (306D3)	6	GPE 73
	530 xd	2993	170	07.2005	12.2010	M57 D30 (306D3)	6	GPE 73
	530 xd	2993	173	01.2007	12.2010	M57 D30 (306D3)	6	GPE 73
	530 d xd	2993	173	09.2008	12.2010	M57 D30 (306D3)	6	GPE 73
	535 d	2993	200	09.2004	12.2010	M57 D30 (306D4)	6	GPE 73
	535 d	2993	210	01.2007	12.2010	M57 D30 (306D5)	6	GPE 73
6 (E63)	635 d	2993	210	07.2007	07.2010	M57 D30 (306D5)	6	GPE 73
6 Cabriolet (E64)	635 d	2993	210	07.2007	07.2010	M57 D30 (306D5)	6	GPE 73
7 (E38)	725 tds	2503	105	04.1996	11.2001	M51 D25 (256T1)	6	G 41
	730 d	2926	135	08.1998	04.2000	M57 D30 (306D1)	6	G 23
	730 d	2926	142	04.2000	11.2001	M57 D30 (306D1)	6	G 23
7 (E65, E66, E67)	730 d	2993	155	10.2002	07.2008	M57 D30 (306D3)	6	GPE 73
	730 d	2993	160	10.2002	07.2008	M57 D30 (306D2)	6	GPE 73
	730 Ld	2993	170	07.2005	12.2009	M57 D30 (306D3)	6	GPE 73
X3 (E83)	2.0 d	1995	110	10.2004	12.2010	M47 D20 (204D4)	4	GPE 73
	3.0 d	2993	150	01.2004	08.2005	M57 D30 (306D2)	6	GPE 73
	3.0 d	2993	160	01.2004	08.2008	M57 D30 (306D3)	6	GPE 73
	3.0 sd	2993	210	09.2006	08.2008	M57 D30 (306D5)	6	GPE 73
	xDrive 30d	2993	155	09.2008	04.2011	M57 D30 (306D3)	6	GPE 73
	xDrive 30d	2993	160	09.2008	04.2011	M57 D30 (306D3)	6	GPE 73
	xDrive 35d	2993	210	09.2008	08.2011	N57 D30 (306D5)	6	GPE 73
X5 (E53)	3.0 d	2925	135	05.2001	12.2003	M57 D30 (306D1)	6	G 23
	3.0 d	2993	160	12.2003	12.2006	M57 D30 (306D2)	6	GPE 73
X5 (E70)	3.0 d	2993	173	02.2007	09.2008	M57 D30 (306D3)	6	GPE 73
	xDrive 30 d	2993	173	09.2008	06.2013	N57 D30 A	6	GPE 73
	3.0 sd	2993	210	09.2007	02.2009	M57 D30 (306D5)	6	GPE 73
	xDrive 35 d	2993	210	09.2008	06.2013	M57 D30 (306D5)	6	GPE 73
X6 (E71, E72)	30 d	2993	173	05.2008	08.2008	M57 D30 (306D3)	6	GPE 73
	xDrive 30 d	2993	173	05.2008	03.2010	M57 D30 (306D3)	6	GPE 73
	35 d	2993	210	05.2008	08.2008	M57 D30 (306D5)	6	GPE 73
	xDrive 35 d	2993	210	06.2007	03.2010	M57 D30 (306D5)	6	GPE 73

CADILLAC

BLS	1.9 D	1910	110	04.2006		Z19DTH	4	G 8
-----	-------	------	-----	---------	--	--------	---	-----

CHEVROLET

AVEO (T300)	NEW 1.3 D	1248	55	07.2011		LDV	4	GPE 80
	NEW 1.3 D	1248	70	07.2011		LSF	4	GPE 80

CHRYSLER

300 C (LX)	NEW 3.0 CRD	2987	160	09.2005	11.2012	M664	6	GPE 83
300 C Touring (LX)	NEW 3.0 CRD	2987	160	09.2005	12.2010	M664	6	GPE 83
PT CRUISER (PT_)	2.2 CRD	2148	89	03.2002		EDJ	4	G 19
	2.2 CRD	2148	110	08.2005			4	G 19
VOYAGER II (ES)	2.5 TD	2500	87	01.1992	09.1995	M00/09B	4	G 40
VOYAGER III (GS)	2.5 TD	2499	85	01.1995	03.2001	425 CLIRS/X	4	G 40

CITROËN

AX (ZA-)	1.4 D 4x4	1360	39	06.1991	07.1992	K9A (TUD3)	4	G 35
	14 D	1360	37	08.1991	12.1997	K9Y (TUD3Y)	4	G 35
	14 D	1360	38	09.1988	06.1992	K9A (TUD3)	4	G 35
	14 D	1360	37	08.1991	12.1997	K9Y (TUD3Y)	4	G 35
	14 D	1360	38	09.1988	06.1992	K9A (TUD3)	4	G 35
	15 D	1527	40	08.1994	12.1997	VJY (TUD5)	4	G 34
	15 D	1527	43	08.1994	12.1997	VJZ (TUD5)	4	G 34
BERLINGO	1.6 HDi 110	1560	80	04.2008		9HZ-DV6TED4	4	G 72
	1.6 HDi 75	1560	55	04.2008		9HT (DV6BTE4)	4	G 72
	1.6 HDi 90	1560	66	04.2008		9HX (DV6ATED4)	4	G 72
	NEW 1.6 HDi 90	1560	68	07.2010		9HX (DV6ATED4)	4	GPE 81
	NEW 1.6 HDi 110	1560	82	07.2010		9HL/9HR (DV6C)	4	GPE 81
	NEW 1.6 HDi 115	1560	84	07.2010		9HR (DV6C)	4	GPE 81
BERLINGO (MF)	1.6 HDi 75	1560	55	07.2005	05.2006	9HW (DV6B)	4	G 6
	1.6 HDi 75	1560	55	06.2006		9HW (DV6B)	4	G 72





kW



Cyl.



CITROËN

	1.6 HDi 110	1560	80	08.2005		DV6TED4	4	G 72
	1.6 HDi 90	1560	66	07.2005		DV6ATED4	4	G 72
	1.6 HDi 90	1560	66	03.2006		9HX (DV6ATED4)	4	G 72
	1.6 HDi 90	1560	66	07.2005	02.2006	9HX (DV6ATED4)	4	G 6
	1.8 D	1769	44	11.1996	10.1999		4	G 41
	1.8 D (MFA9A)	1769	43	07.1998		A9A (XUD7)	4	G 41
	1.9 D (MFDJY)	1905	50	07.1996		D9B (XUD9A/L)/DJY (XUD9A)	4	G 41
	1.9 D (MFWJZ)	1868	51	07.1998	10.2005	WJY (DW8B)/WJZ (DW8)	4	G 34
	1.9 D 4WD (MFWJZ)	1868	51	07.1998	10.2005	WJZ (DW8)	4	G 34
	2.0 HDi	1997	66	11.2002	10.2005	DW10TD	4	G 57
	2.0 HDi 4x4	1997	66	11.2002	10.2005	DW10TD	4	G 57
	2.0 HDi 90 (MFRHY)	1997	66	12.1999		RHY (DW10TD)	4	G 57
BERLINGO Camionnette	1.6 HDi 110	1560	80	04.2008		9HZ-DV6TED4	4	G 72
	1.6 HDi 75	1560	55	04.2008		9HT (DV6ATED4)	4	G 72
	1.6 HDi 90	1560	66	04.2008		9HX (DV6ATED4)	4	G 72
	1.6 HDi 110	1560	80	04.2008		9HZ (DV6ATED4)	4	G 72
	NEW 1.6 BlueHdi 75	1560	55	07.2010		9HN (DV6ETED), BHW (DV6FE)	4	GPE 81
	NEW 1.6 HDi 90	1560	66	07.2010		9HX (DV6ATED4), 9HS (DV6TED4BU)	4	GPE 81
	NEW 1.6 HDi 90	1560	68	07.2010		9HP (6V6DTE)	4	GPE 81
	NEW 1.6 HDi 92	1560	68	07.2010		9HJ (DV6DTE)	4	GPE 81
	NEW 1.6 BlueHdi 100	1560	73	12.2014		BHY (DV6FD)	4	GPE 81
	NEW 1.6 HDi 110	1560	82	07.2010		9HL/9HR (DV6C)	4	GPE 81
	NEW 1.6 HDi 115	1560	84	07.2010		9HR (DV6C)	4	GPE 81
BERLINGO Camionnette	NEW 1.6 HDi 120	1560	88	12.2014		BHZ (DV6FC)	4	GPE 81
BERLINGO Camionnette (M_)	1.6 HDi 75	1560	55	07.2005	05.2006	9HW (DV6B)	4	G 6
	1.6 HDi 75	1560	55	07.2006		9HW (DV6B)	4	G 72
	1.6 HDi 90	1560	66	03.2006		DV6ATED4	4	G 72
	1.6 HDi 90	1560	66	07.2005	02.2006	DV6ATED4	4	G 6
	1.8 D (MBA9A, MCA9A)	1769	43	07.1996		A9A (XUD7)	4	G 41
	1.9 D	1905	51	07.1996		DJY (XUD9A)	4	G 41
	1.9 D 70 4WD	1868	51	07.1998		WJZ (DW8)	4	G 34
	1.9 D 70 (MBWJZ, MCWJZ)	1868	51	04.1999		WJZ (DW8)	4	G 34
	2.0 HDi 90 4WD	1997	66	11.2000		RHY (DW10TD)	4	G 57
	2.0 HDi 90 (MBRHY, MCRHY)	1997	66	12.1999		RHY (DW10TD)	4	G 57
BX (XB-)	1.8 D	1769	44	10.1985	09.1993	161 (XUD7)	4	G 41
	19 D	1905	47	09.1983	12.1987	D9A (XUD9)/162 (XUD9)	4	G 41
	19 D	1905	51	03.1987	02.1993	D9B (XUD9A/U)	4	G 41
	TRD Turbo	1769	66	03.1988	02.1993	AJZ (XUD7TE)/A8A (XUD7TE)	4	G 41
BX Break (XB-)	18 D	1769	44	10.1985	09.1993	161A (XUD7)	4	G 41
	19 D	1905	47	09.1983	12.1987	D9A (XUD9)/162 (XUD9)	4	G 41
	19 D	1905	51	03.1987	12.1994	D9B (XUD9A/U)	4	G 41
	TRD Turbo	1769	66	03.1988	12.1994	AJZ (XUD7TE)/A8A (XUD7TE)	4	G 41
C1 (PM_, PN_)	1.4 HDi	1398	40	06.2005		DV4D	4	G 72
C15 (VD-)	1.8 D	1769	44	07.1986	12.2000	161A (XUD7)	4	G 41
	1.9 D	1868	44	12.2000	12.2005		4	G 34
C15 Kombi	1.8 D	1769	44	04.1987	08.2000		4	G 41
C2 (JM_)	1.4 HDi	1398	50	09.2003		8HX (DV4TD)	4	G 6
	1.6 HDi	1560	80	09.2005	06.2007	9HZ-DV6TED4	4	G 6
	1.6 HDi	1560	80	07.2007		9HZ-DV6TED4	4	G 72
C25 Bus (280_, 290_)	1.9 D	1905	51	07.1987	02.1994	D9B (XUD9A/U)	4	G 41
	1.9 TD	1930	60	04.1992	02.1994	M705	4	G 41
	2.5 D	2500	54	10.1985	02.1994	CRD93L (U25-661)	4	G 41
	2.5 D 4x4	2500	54	01.1987	02.1994	CRD93L (U25-661)	4	G 41
	2.5 D Turbo	2500	70	08.1987	02.1994	CRD93LS (U25-673)	4	G 41
	2.5 D Turbo 4x4	2500	70	08.1987	02.1994	CRD93LS (U25-673)	4	G 41
C25 Camionnette (280_, 290_)	1.9 D 1400	1905	51	01.1988	01.1994	DJY (XUD9A)	4	G 41
	2.5 D 4x4	2498	55	11.1983	12.1986	CRD93L (U25-661)	4	G 41
	2.5 DT	2498	70	08.1991	01.1994	CRD93LS (U25-673)	4	G 41
C25 Camion/Plate-forme (280_, 290_)	1.9 DT	1929	60	10.1991	01.1994		4	G 41
	2.5 D	2498	55	11.1983	01.1994	CRD93L (U25-661)	4	G 41
	2.5 DT	2498	70	01.1987	01.1994	CRD93LS (U25-673)	4	G 41
C3 (FC_)	1.4 16V HDi	1398	66	02.2002		8HY (DV4TED4)	4	G 6
	1.4 HDi	1398	50	02.2002		8HX (DV4TD)	4	G 6
	1.4 HDi	1398	52	07.2003		8HZ (DV4TD)	4	G 72
	1.4 HDi	1398	55	05.2005		8HX (DV4TD)	4	G 72

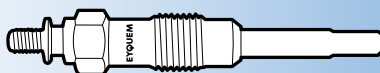



kW



Cyl.



CITROËN

	1.6 16V HDi	1560	80	06.2006		DV6TED4	4	G 72
	1.6 16V HDi	1560	66	06.2006		9HX (DV6ATED4)	4	G 72
	1.6 16V HDi	1560	66	10.2005	05.2006	9HX (DV6ATED4)	4	G 6
	1.6 16V HDi	1560	80	09.2005	05.2006	DV6TED4	4	G 6
C3 II	1.4 HDi 70	1398	50	11.2009		8HZ (DV4TD)	4	G 72
	1.6 HDi 90	1560	66	11.2009		9HX (DV6ATED4)/DV6ATED4	4	G 72
	NEW 1.6 HDi	1560	68	11.2009		9HP (DV6DTED)	4	GPE 81
	NEW 1.6 HDi 110	1560	82	11.2009		9HR (DV6C)	4	GPE 81
	NEW 1.6 HDi 115	1560	84	09.2012		9HD (DV6C)	4	GPE 81
	NEW 1.6 BlueHDi 75	1560	55	04.2015		BHW (DV6FE)	4	GPE 81
	NEW 1.6 BlueHDi 100	1560	73	07.2014		BHY (DV6FD)	4	GPE 81
C3 III (SX)	NEW 1.6 BlueHDi 75	1560	55	07.2016		BHW (DV6FE)	4	GPE 81
	NEW 1.6 BlueHDi 100	1560	73	07.2016		BHY (DV6FD)	4	GPE 81
C3 AIRCROSS II	NEW 1.6 BlueHDi 100	1560	73	07.2017		BHY (DV6FD)	4	GPE 81
	NEW 1.6 BlueHDi 120	1560	88	07.2017		BHZ (DV6FC)	4	GPE 81
C3 Picasso	1.6 HDi	1560	66	02.2009		9HX (DV6ATED4)	4	G 72
	1.6 HDi	1560	80	02.2009		9HZ (DV6TED4)	4	G 72
	NEW 1.6 HDi 90	1560	68	07.2010		9HP (DV6DTED)	4	GPE 81
	NEW 1.6 HDi 110	1560	82	05.2010		9HR (DV6C)	4	GPE 81
	NEW 1.6 HDi 115	1560	84	01.2013		9HL (DV6C)	4	GPE 81
	NEW 1.6 BlueHDi 100	1560	73	01.2015		BHY (DV6FD)	4	GPE 81
C3 Pluriel (HB_)	1.4 HDi	1398	50	12.2004		8HX (DV4TD)	4	G 72
	1.4 HDi	1398	50	04.2004	11.2004	8HX (DV4TD)	4	G 6
C35 Bus	2.5 D	2498	51	02.1980	01.1994	B25637	4	G 41
C35 Kasten	2.5 D	2498	51	02.1980	01.1994	B25637	4	G 41
C35 Pick-up	2.2 D	2175	45	11.1973	01.1980	B22615	4	G 41
	2.5 D	2498	51	02.1980	01.1994	B25637	4	G 41
C4 AIRCROSS	NEW 1.6 HDi 115, AWC	1560	84	04.2012		9HL (DV6C)	4	GPE 81
C4 CACTUS	NEW 1.6 HDi 90	1560	68	09.2014		9HP (DV6DTED)	4	GPE 81
	NEW 1.6 BlueHDi 100	1560	73	09.2014		BHY (DV6FD)	4	GPE 81
C4 (LC_)	1.6 HDi	1560	80	06.2006	07.2011	9HY (DV6TED4)/9HZ-DV6TED4/DV6TED4	4	G 72
	1.6 HDi	1560	80	11.2004	05.2006	9HY (DV6TED4)/9HZ-DV6TED4/DV6TED4	4	G 6
	1.6 HDi	1560	66	11.2004		9HX (DV6ATED4)	4	G 6
	2.0 HDi	1997	100	11.2004	07.2011	RHR (DW10BTED4)/DW10BTED4	4	G 30
	2.0 HDi	1997	103	07.2008	07.2011	RHF (DW10BTED4)	4	G 30
C4 II (B7)	NEW 1.6 HDi 90	1560	68	11.2009		9HP (DV6DTED)	4	GPE 81
	NEW 1.6 BlueHDi 100	1560	73	07.2014		BHY (DV6FD)	4	GPE 81
	NEW 1.6 HDi 110	1560	82	11.2009		9HR (DV6C)	4	GPE 81
	NEW 1.6 HDi 115	1560	84	07.2012		9HR (DV6C)	4	GPE 81
	NEW 1.6 BlueHDi 115	1560	85	08.2014		BHX (DV6FC)	4	GPE 81
	NEW 1.6 BlueHDi 120	1560	88	02.2015		BHZ (DV6FC)	4	GPE 81
	NEW 2.0 HDi 150	1997	110	11.2009		RHE (DW10CTED4)	4	GPE 81
C4 Coupe (LA_)	1.6 HDi	1560	80	11.2004	07.2011	9HZ (DV6TED4)/9HZ-DV6TED4/DV6TED4	4	G 72
	1.6 HDi	1560	80	11.2004	07.2011	9HY (DV6TED4)/9HZ-DV6TED4/DV6TED4	4	G 6
	1.6 HDi	1560	66	11.2004	07.2011	9HX (DV6ATED4)	4	G 72
	1.6 HDi	1560	66	11.2004	07.2011	9HV (DV6ATED4)	4	G 6
	2.0 HDi	1997	100	11.2004	12.2010	RHR (DW10BTED4)/DW10BTED4	4	G 30
C4 Grand Picasso I (UA_)	1.6 HDi	1560	80	11.2004	07.2011	9HY (DV6TED4)/9HZ (DV6TED4)	4	G 72
C4 Grand Picasso (UA_)	2.0 HDi	1997	100	07.2008	07.2011	RHF (DW10BTED4)	4	G 30
C4 Grand Picasso I (UA_)	NEW 1.6 HDi 110	1560	82	09.2010		9HL/9HR (DV6C)	4	GPE 81
	2.0 HDi 138	1997	100	10.2006		RHJ (DW10BTED4)/RHR (DW10BTED4)	4	G 57
	NEW 2.0 HDi 150	1997	110	07.2009		RHE (DW10CTED4)	4	GPE 81
	NEW 2.0 HDi 165	1997	120	09.2010		RHH (DW10CTED4)	4	GPE 81
C4 Grand Picasso II	NEW 1.6 HDi 90	1560	68	09.2013		9HP (DV6DTED)	4	GPE 81
	NEW 1.6 BlueHDi 100	1560	73	01.2015		BHY (DV6FD)	4	GPE 81
	NEW 1.6 BlueHDi 115	1560	85	09.2013		9HC (DV6C)/BHX (DV6FC)	4	GPE 81
	NEW 1.6 BlueHDi 120	1560	88	07.2014		BHZ (DV6FC)	4	GPE 81
	NEW 2.0 BlueHDi 135	1997	100	09.2013		AHV (DW10FDD)	4	GPE 81
	NEW 2.0 BlueHDi 150	1997	110	09.2013		AHX (DW10FD)	4	GPE 81
C4 Picasso (UD_)	1.6 HDi	1560	80	02.2007	08.2013	9HY (DV6TED4)/9HZ (DV6TED4)	4	G 72
	NEW 1.6 HDi 110	1560	82	09.2010	08.2013	9HR (DV6C)	4	GPE 81
	2.0 HDi	1997	100	02.2007	08.2013	RHJ-DW10BTED4/RHR (DW10BTED4)	4	G 72
	NEW 2.0 HDi 150	1997	110	07.2009	08.2013	RHE (DW10CTED4)	4	GPE 81
	NEW 2.0 HDi 165	1997	120	09.2010	08.2013	RHH (DW10CTED4)	4	GPE 81
C4 Picasso I (UD_)	NEW 1.6 HDi 110	1560	82	09.2010		9HL (DV6C)	4	GPE 81

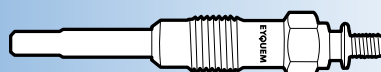



kW



Cyl.



CITROËN

	NEW	2.0 HDi 150	1997	110	07.2009		RHE (DW10CTED4)	4	GPE 81
	NEW	2.0 HDi 165	1997	120	09.2010		RHH (DW10CTED4)	4	GPE 81
C4 Picasso II	NEW	1.6 HDi 90	1560	68	02.2013		9HP (DV6DTEd)	4	GPE 81
	NEW	1.6 BlueHDi 100	1560	73	12.2014		BHY (DV6FD)	4	GPE 81
	NEW	1.6 BlueHDi 115	1560	85	09.2013		9HC (DV6C)/BHX(DV6FC)	4	GPE 81
	NEW	1.6 BlueHDi 120	1560	88	07.2014		BHZ (DV6FC)	4	GPE 81
	NEW	2.0 BlueHDi 135	1997	100	09.2013		AHV (DW10FDD)	4	GPE 81
	NEW	2.0 BlueHDi 150	1997	110	09.2013		AHX (DW10FD)	4	GPE 81
C4 Tricorps		1.6 HDi	1560	80	07.2006		DV6TED4	4	G 72
C5 (DC_)		2.0 HDi	1997	79	03.2001	08.2004	RHZ (DW10ATED)/RHS (DW10ATED)	4	G 57
		2.0 HDi (DCRHYB)	1997	66	03.2001	08.2004	RHY (DW10TD)	4	G 57
		2.0 HDi (DCRHZB, DCRHZE)	1997	80	03.2001	08.2004	RHZ (DW10ATED)	4	G 57
		2.2 HDi (DC4HXB, DC4HXE)	2179	98	03.2001	08.2004	4HX (DW12TED4/FAP)	4	G 30
		2.2 HDi (DC4HXB, DC4HXE)	2179	98	03.2001	08.2004	4HX (DW12TED4/FAP)	4	G 57
C5 II (RC_)		1.6 HDi (RC8HZB)	1560	80	09.2004		9HY (DV6TED4)/ 9HZ (DV6TED4)	4	G 72
		1.6 HDi (RC8HZB)	1560	80	09.2004		9HY (DV6TED4)/ 9HZ (DV6TED4)	4	G 6
		2.0 HDi (RCRHRH)	1997	100	09.2004		DW10BTED4	4	G 30
		2.2 HDi (RC4HXE)	2179	98	09.2004		4HX (DW12TED4/FAP)	4	G 57
	NEW	2.2 HDi	2179	125	04.2006		4HT (DW12BTED4)	4	G 88
C5 III (RD_)		1.6 HDi	1560	80	02.2008		9HZ (DV6TED4)	4	G 72
C5 III (RD)	NEW	1.6 HDi 110	1560	82	07.2010		9HR, 9HL (DV6C)	4	GPE 81
	NEW	1.6 HDi 115	1560	84	01.2012		9HR, 9HL (DV6C)	4	GPE 81
C5 III (RD_)		2.0 HDi	1997	100	02.2008		RHR (DW10BTED4)	4	G 30
		2.0 HDi	1997	103	04.2009		RHF (DW10BTED4)	4	G 30
C5 III (RD)	NEW	2.0 HDi 150 /BlueHDi 150	1997	110	09.2009		RHE (DW10CTED4), AHR (DW10FD)	4	GPE 81
	NEW	2.0 HDi 165	1997	120	04.2009		RHH (DW10CTED4)	4	GPE 81
	NEW	2.0 HDi 180	1997	133	03.2015		AHW (DW10FC)	4	GPE 81
	NEW	2.2 HDi	2179	125	02.2008		4HT (DW12BTED4)	4	G 88
C5 III (RD_)		2.7 HDi	2720	150	02.2008		DT17ED4	6	G 5
C5 Break (DE_)		2.0 HDi	1997	80	06.2001	08.2004	RHZ (DW10ATED)	4	G 57
		2.0 HDi (DERHSB, DERHSE)	1997	79	06.2001	08.2004	RHZ (DW10ATED)/RHS (DW10ATED)	4	G 57
		2.0 HDi (DERHYB)	1997	66	06.2001	08.2004	RHY (DW10TD)	4	G 57
		2.2 HDi (DE4HXB, DE4HXE)	2179	98	06.2001	08.2004	4HX (DW12TED4/FAP)	4	G 30
		2.2 HDi (DE4HXB, DE4HXE)	2179	98	06.2001	08.2004	4HX (DW12TED4/FAP)	4	G 57
C5 II Break (RE_)		1.6 HDi (RE8HZB)	1560	80	09.2004		9HY (DV6TED4), 9HZ(DV6TED4)	4	G 72
		1.6 HDi (RE8HZB)	1560	80	09.2004		9HY (DV6TED4), 9HZ(DV6TED4)	4	G 6
		2.0 HDi (RERHRH)	1997	100	09.2004		RHR (DW10BTED4)	4	G 30
		2.2 HDi (RE4HXE)	2179	98	09.2004		4HX (DW12TED4/FAP)	4	G 57
	NEW	2.2 HDi (RE)	2179	120	05.2006		4HP/4HR (DW12BTED4)	4	G 88
	NEW	2.2 HDi (RE)	2179	125	04.2006		4HT (DW12BTED4)	4	G 88
C5 III Break (RW_)		1.6 HDi	1560	80	02.2008		9HZ (DV6TED4)	4	G 72
	NEW	1.6 HDi 110	1560	82	07.2010		9HR, 9HL (DV6C)	4	GPE 81
	NEW	1.6 HDi 115	1560	84	01.2012		9HR, 9HL (DV6C)	4	GPE 81
		2.0 HDi	1997	100	02.2008		RHR (DW10BTED4)	4	G 30
		2.0 HDi	1997	103	04.2009		RHF (DW10BTED4)	4	G 30
	NEW	2.0 HDi 150 /BlueHDi 150	1997	110	09.2009		RHE (DW10CTED4), AHR (DW10FD)	4	GPE 81
	NEW	2.0 HDi 165	1997	120	04.2009		RHH (DW10CTED4)	4	GPE 81
		2.7 HDi	2720	150	02.2008		UHZ (DT17BTED4)/DT17ED4	6	G 5
	NEW	2.0 HDi 165	1997	120	04.2009		RHH (DW10CTED4)	4	GPE 81
	NEW	2.0 HDi 180	1997	133	03.2015		AHW (DW10FC)	4	GPE 81
	NEW	2.2 HDi	2179	125	02.2008		4HT (DW12BTED4)	4	G 88
	NEW	2.2 HDi 165	2179	120	02.2008		4HP (DW12BTED4)	4	G 88
		2.7 HDi	2720	150	02.2008		UHZ (DT17BTED4)/DT17ED4	6	G 5
C6 (TD_)	NEW	2.2 HDi	2179	120	06.2006		4HP (DW12BTED4)	4	G 88
	NEW	2.2 HDi	2179	125	06.2006		4HT (DW12BTED4)	4	G 88
		2.7 HDi	2720	150	09.2005		UHZ (DT17BTED4)/DT17ED4	6	G 5
C8 (EA_, EB_)		2.0 HDi	1997	79	07.2002		RHT (DW10ATED4)/RHM (DW10ATED4)/ RHW (DW10ATED4)	4	G 57
		2.0 HDi	1997	80	07.2002	04.2003	RHW (DW10ATED4)	4	G 57
		2.0 HDi	1997	80	05.2003		RHW (DW10ATED4)	4	G 30
		2.0 HDi	1997	88	07.2006		RHK (DW10UTED4)	4	G 30
		2.0 HDi 135	1997	100	03.2006	05.2010	RHR (DW10BTED4), RHD (DW10CTED4)	4	G 30
	NEW	2.0 HDi 135	1997	100	06.2010		RHR (DW10BTED4), RHD (DW10CTED4)	4	GPE 81
	NEW	2.0 HDi 165	1997	120	03.2006		RHE/RHH (DW10CTED4)	4	GPE 81
		2.2 HDi	2179	94	05.2003		4HW (DW12TED4)	4	G 30

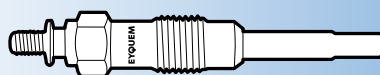



kW



Cyl.



CITROËN

		2.2 HDi	2179	94	07.2002	04.2003	4HW (DW12TED4)	4	G 57
	NEW	2.2 HDi	2179	120	06.2007		4HP/4HR (DW12BTED4)	4	G 88
	NEW	2.2 HDi	2179	125	06.2006		4HT (DW12BTED4)	4	G 88
C-CROSSER (EP_)	NEW	2.2 HDi	2179	115	02.2007		4HN (DW12MTED4)	4	G 88
C-ELYSEE	NEW	1.6 HDi 92	1560	68	11.2012		9HP (DV6DTE), 9HJ (DV6DTEDM)	4	GPE 81
	NEW	1.6 BlueHDi 100	1560	73	11.2014		BHY (DV6FD)	4	GPE 81
CX I (MA)		25 D Turbo	2500	70	04.1983	08.1985	M25-648	4	G 41
		2500 D	2500	55	02.1978	06.1982	M25-629	4	G 41
CX I Break (MA)		2500 D	2500	55	02.1978	08.1985	M25-629	4	G 41
		2500 D Turbo	2500	70	04.1983	08.1985	M25-648	4	G 41
CX II		25 D	2500	54	08.1985	12.1992	M25-660	4	G 41
		25 D Turbo	2500	70	08.1985	12.1986	M25-648	4	G 41
		25 D Turbo	2500	88	01.1987	12.1992	M25-669	4	G 41
CX II Break		25 D	2500	54	05.1986	12.1992	M25-660	4	G 41
		25 D Turbo 2	2500	88	01.1987	12.1992	M25-669	4	G 41
		2500 D Turbo	2500	70	08.1985	12.1986	M25-648	4	G 41
DS3	NEW	1.4 HDi 70	1398	50	04.2010	07.2015	8HR (DV4C)	4	GPE 81
	NEW	1.6 HDi 90	1560	68	11.2009	07.2015	9HP (DV6DTE)	4	GPE 81
	NEW	1.6 BlueHDi 75	1560	55	03.2015	07.2015	BHW (DV6FE)	4	GPE 81
	NEW	1.6 BlueHDi 100	1560	73	07.2014	07.2015	BHY (DV6FD)	4	GPE 81
	NEW	1.6 HDi 110	1560	82	11.2009	07.2015	9HR (DV6C)	4	GPE 81
	NEW	1.6 HDi 115	1560	84	08.2012	07.2015	9HL, 9HD (DV6C)	4	GPE 81
	NEW	1.6 HDi 115	1560	85	10.2013	07.2015	BHX (DV6FC)	4	GPE 81
	NEW	1.6 BlueHDi 120	1560	88	10.2013	07.2015	BHZ (DV6FC)	4	GPE 81
DS3 Cabrio	NEW	1.6 HDi 90	1560	69	01.2013	07.2015	9HP (DV6DTE)	4	GPE 81
	NEW	1.6 BlueHDi 100	1560	73	07.2014	07.2015	BHY (DV6FD)	4	GPE 81
	NEW	1.6 BlueHDi 115	1560	85	10.2013	07.2015	BHX (DV6FC)	4	GPE 81
	NEW	1.6 BlueHDi 120	1560	88	07.2014	07.2015	BHZ (DV6FC)	4	GPE 81
DS4	NEW	1.6 HDi 90	1560	68	05.2011	07.2015	9HP (DV6DTE)	4	GPE 81
	NEW	1.6 HDi 110	1560	81	04.2011	07.2015		4	GPE 81
	NEW	1.6 HDi 110	1560	82	04.2011	07.2015	9HR (DV6C)	4	GPE 81
	NEW	1.6 HDi 115	1560	84	08.2012	07.2015	9HL, 9HD (DV6C)	4	GPE 81
	NEW	1.6 BlueHDi 115	1560	85	08.2014	07.2015	BHX (DV6FC)	4	GPE 81
	NEW	1.6 BlueHDi 120	1560	88	07.2014	07.2015	BHZ (DV6FC)	4	GPE 81
	NEW	2.0 HDi 135	1997	100	09.2011	07.2015	RHE (DW10CTED4)	4	GPE 81
	NEW	2.0 BlueHDi 150	1997	110	07.2014	07.2015	AHX (DW10FD)	4	GPE 81
	NEW	2.0 BlueHDi 150 Hybrid	1997	110	07.2014	07.2015	AHR (DW10FD)	4	GPE 81
	NEW	2.0 HDi 165	1997	120	04.2011	07.2015	RHH (DW10CTED4)	4	GPE 81
	NEW	2.0 BlueHDi 180	1997	133	04.2011	07.2015	AHW (DW10FC)	4	GPE 81
DS5	NEW	1.6 HDi 110	1560	82	11.2011	07.2015	9HR (DV6C)	4	GPE 81
	NEW	1.6 HDi 115	1560	84	11.2013	07.2015	9HD (DV6C)	4	GPE 81
	NEW	1.6 HDi 115	1560	84	11.2013	07.2015	BHX (DV6FC)	4	GPE 81
	NEW	1.6 BlueHDi 120	1560	88	07.2014	07.2015	BHZ (DV6FC)	4	GPE 81
	NEW	2.0 HDi 135	1997	100	11.2011	07.2015	RHD (DW10CB)	4	GPE 81
	NEW	2.0 BlueHDi 150	1997	110	07.2014	07.2015	AHX (DW10FD)	4	GPE 81
	NEW	2.0 BlueHDi 150 Hybrid	1997	110	11.2011	07.2015	AHX (DW10FD)	4	GPE 81
	NEW	2.0 HDi 165	1997	120	11.2011	07.2015	RHH (DW10CTED4)	4	GPE 81
DS5 Hybrid4	NEW	2.0 HDi 165 Hybrid	1997	120	12.2011	07.2015	RHC (DW10CTED4)	4	GPE 81
	NEW	2.0 HDi 180	1997	133	08.2013	07.2015	AHW (DW10FC)	4	GPE 81
EVASION (22, U6)		1.9 TD	1905	66	11.1994	07.2002	DHX (XUD9TF/BTF)/D8B (XUD9TF)	4	G 41
		1.9 TD	1905	68	10.1995	12.1998	D8B (XUD9TF)	4	G 41
		2.0 HDi	1997	80	08.1999	07.2002	RHZ (DW10ATED)	4	G 57
		2.0 HDi 16V	1997	80	09.1999	07.2002	RHW (DW10ATED4)	4	G 57
		2.0 TD	1998	68	05.1997	07.2002		4	G 41
		2.1 TD	2088	80	05.1996	07.2002	P8C (XUD11BTE)	4	G 41
GRAND C4 SPACETOURER	NEW	1.6 BlueHDi 100	1560	73	04.2018		BHY (DV6FD)	4	GPE 81
	NEW	1.6 BlueHDi 120	1560	88	04.2018		BHZ (DV6FC)	4	GPE 81
	NEW	2.0 BlueHDi 150	1997	110	04.2018		AHX-AHR (DW10FD)	4	GPE 81
	NEW	2.0 BlueHDi 160	1997	120	04.2018		EHY (DW10FCC)	4	GPE 81
JUMPER Autobus	NEW	2.0 BlueHDi 110	1997	81	07.2015		AHM (DW10FUE)	4	GPE 81
	NEW	2.0 BlueHDi 130	1997	96	07.2015		AHN (DW10FUD)	4	GPE 81
	NEW	2.0 BlueHDi 160	1997	120	07.2015		AHP (DW10FUC)	4	GPE 81
		2.2 HDi 100	2198	74	04.2006		4HV (P22DTE)	4	G 65
	NEW	2.2 HDi 110	2198	81	07.2011		4HG (P22DTE)	4	GPE 92
		2.2 HDi 120	2198	88	04.2006		4HU (P22DTE)	4	G 65

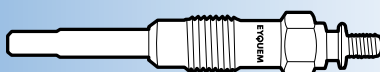



kW



Cyl.



CITROËN

	NEW	2.2 HDi 130	2198	96	07.2011		4HH (P22DTE)	4	GPE 92
	NEW	2.2 HDi 150	2198	110	07.2011		4HJ (P22DTE)	4	GPE 92
		3.0 HDi 155	2999	115	07.2010		F1CE0481D (F30DT)	4	G 9
		3.0 HDi 160	2999	116	09.2006		F1CE0481D (F30DT)	4	G 9
		3.0 HDi 180	2999	130	07.2011		F1CE0481D (F30DT)	4	G 9
JUMPER Bus (230P)		1.9 D	1905	51	01.1999	04.2002	D9B (XUD9A/U)	4	G 41
		1.9 TD	1905	66	08.1994	04.2002	D8C (XUD9UTF)	4	G 41
		1.9 TD	1905	68	02.1994	04.2002	D8C (XUD9UTF)	4	G 41
		1.9 TD 4x4	1905	68	08.1996	04.2002	D8C (XUD9UTF)	4	G 41
		2.5 D	2446	63	08.1994	04.2002	T9A (DJ5)	4	G 41
		2.5 D 4x4	2446	63	08.1996	04.2002	T9A (DJ5)	4	G 41
		2.5 TD	2446	76	08.1994	04.2002	T8A (DJ5T)	4	G 41
		2.5 TD 4x4	2446	76	08.1996	04.2002	T8A (DJ5T)	4	G 41
		2.5 TDi	2446	79	12.1996	11.2000	THX (DJ5TED)	4	G 55
		2.5 TDi 4x4	2446	79	12.1996	11.2000	THX (DJ5TED)	4	G 55
		2.8 D	2798	64	01.1999	02.2002	8140.63 (F28D)	4	G 62
		2.8 HDi 4x4	2798	94	09.2000	04.2002	8140.43S	4	G 62
JUMPER Bus (244, Z_)		2.0 HDi	1997	62	04.2002		DW10UTD	4	G 57
		2.2 HDi	2179	74	04.2002		DW12TED	4	G 57
JUMPER Camionnette	NEW	2.0 BlueHDi 110	1997	81	04.2016		AHM (DW10FUE)	4	GPE 81
	NEW	2.0 BlueHDi 130	1997	96	04.2016		AHN (DW10FUD)	4	GPE 81
	NEW	2.0 BlueHDi 160	1997	120	04.2016		AHP (DW10FUC)	4	GPE 81
		2.2 HDi 100	2198	74	04.2006		4HV (P22DTE)	4	G 65
	NEW	2.2 HDi 110	2198	81	07.2011		4HG (P22DTE)	4	GPE 92
	NEW	2.2 HDi 130	2198	96	07.2011		4HH (P22DTE)	4	GPE 92
	NEW	2.2 HDi 150	2198	110	07.2011		4HJ (P22DTE)	4	GPE 92
		2.2 HDi 120	2198	88	04.2006		4HU (P22DTE)	4	G 65
		3.0 HDi 145	2999	107	07.2010		F1CE3481N	4	G 9
		3.0 HDi 155	2999	115	07.2010		F1CE0481D (F30DT)	4	G 9
		3.0 HDi 160	2999	116	09.2006		F1CE0481D (F30DT)	4	G 9
		3.0 HDi 180	2999	130	07.2011		F1CE0481D (F30DT)	4	G 9
JUMPER Camionnette (230L)		1.9 D	1905	51	02.1994	04.2002	D9B (XUD9A/U)	4	G 41
		1.9 D	1905	50	07.1999	04.2002	DJY (XUD9A)	4	G 41
		1.9 TD	1905	66	03.1994	04.2002	DHX (XUD9TF/BTF)	4	G 41
		1.9 TD	1905	68	03.1994	04.2002	D8C (XUD9UTF)	4	G 41
		2.0 HDi	1997	62	11.2001	04.2002	RHV (DW10UTD)	4	G 57
		2.5 D	2446	63	03.1994	04.2002	T9A (DJ5)	4	G 41
		2.5 D 4x4	2446	63	03.2000	04.2002	T9A (DJ5)	4	G 41
		2.5 DT 4x4	2446	76	10.1996	08.1997	THZ (DJ5T)	4	G 41
		2.5 TD	2446	76	03.1994	04.2002	T8A (DJ5T)	4	G 41
		2.5 TDi	2446	79	12.1996	11.2000	THX (DJ5TED)	4	G 55
		2.5 TDi 4x4	2446	79	03.2000	11.2000	THX (DJ5TED)	4	G 55
		2.8 D	2798	64	01.1999	02.2002	8140.63 (F28D)	4	G 62
		2.8 HDi 4x4	2798	94	09.2000	04.2002	8140.43S	4	G 62
JUMPER Camionnette (244)		2.0 HDi	1997	62	04.2002		RHV (DW10UTD, DW10TD)	4	G 57
		2.2 HDi	2179	74	04.2002		4HY (DW12TED)	4	G 57
		2.8 HDi 4x4	2798	94	04.2002		8140.43S	4	G 62
		2.8 HDi	2798	107	05.2004		8140.43N	4	G 62
JUMPER Camion/Plate-forme	NEW	2.0 BlueHDi 110	1997	81	04.2016		AHM (DW10FUE)	4	GPE 81
	NEW	2.0 BlueHDi 130	1997	96	04.2016		AHN (DW10FUD)	4	GPE 81
	NEW	2.0 BlueHDi 160	1997	120	04.2016		AHP (DW10FUC)	4	GPE 81
		2.2 HDi 100	2198	74	04.2006		4HV (P22DTE)	4	G 65
	NEW	2.2 HDi 110	2198	81	07.2011		4HG (P22DTE)	4	GPE 92
	NEW	2.2 HDi 130	2198	96	07.2011		4HH (P22DTE)	4	GPE 92
	NEW	2.2 HDi 150	2198	110	07.2011		4HJ (P22DTE)	4	GPE 92
		2.2 HDi 120	2198	88	04.2006		4HU (P22DTE)	4	G 65
		3.0 HDi 145	2999	107	07.2010		F1CE3481N	4	G 9
		3.0 HDi 160	2999	116	09.2006		F1CE0481D (F30DT)	4	G 9
		3.0 HDi 180	2999	130	07.2011		F1CE0481D (F30DT)	4	G 9
JUMPER Camion/Plate-forme (230)		1.9 TD	1905	66	03.1994	04.2002	DHX (XUD9TF/BTF)	4	G 41
		1.9 TD	1905	68	03.1994	04.2002	D8C (XUD9UTF)	4	G 41
		2.5 D	2446	63	03.1994	04.2002	T9A (DJ5)	4	G 41
		2.5 D 4X4	2446	63	03.2000	04.2002	T9A (DJ5)	4	G 41
		2.5 TD	2446	76	03.1994	04.2002	T8A (DJ5T)	4	G 41
		2.5 TDi	2446	79	12.1996	04.2002	THX (DJ5TED)	4	G 55





kW



Cyl.



CITROËN

	2.5 TDi 4x4	2446	79	03.2000	04.2002	THX (DJ5TED)	4	G 55
	2.8 D	2798	64	01.1999	02.2002	8140.63 (F28D)	4	G 62
	2.8 HDi	2798	93	10.2000	01.2002	8140.43S	4	G 62
	2.8 HDi 4x4	2798	94	09.2000	04.2002	8140.43S	4	G 62
JUMPER Camion/Plate-forme (244)	2.0 HDi	1997	62	04.2002		RHV (DW10UTD)	4	G 57
	2.2 HDi	2179	74	02.2002	06.2006	4HY (DW12UTED)	4	G 57
	2.2 HDi 16V	2179	74	04.2002		DW12TED	4	G 57
	2.8 HDi	2798	94	04.2002		8140.43S	4	G 62
	2.8 HDi	2798	107	05.2004		8140.43N	4	G 62
	2.8 HDi 4x4	2798	94	02.2002	06.2006	F28TDCR	4	G 62
JUMPY	1.6 HDi 90	1560	66	01.2007		9HU (DV6UTED4)	4	G 72
	NEW 2.0 HDi 90 8v	1997	66	10.2010		9HM (DV6UC), 9HH (DV6DUM)	4	GPE 81
	NEW 2.0 HDi 95	1997	72	07.2011		AHY (DW10CE)	4	GPE 81
	2.0 HDi 120	1997	88	01.2007		RHK (DW10UTED4)	4	G 30
	2.0 HDi 140	1997	100	01.2007		RHR (DW10BTED4)	4	G 30
	NEW 2.0 HDi 125	1997	94	07.2011		AHZ (DW10CD)	4	GPE 81
	NEW 2.0 HDi 165	1997	120	07.2010		RHH (DW10CTED4)	4	GPE 81
JUMPY (VA_, VE)	NEW 1.6 BlueHDi 95	1560	70	04.2016		BHV-BHS (DV6FDU)	4	GPE 81
	NEW 1.6 BlueHDi 115	1560	85	04.2016		BHX (DV6FCU)	4	GPE 81
	NEW 2.0 BlueHDi 150	1997	110	04.2016		AHX-AHR (DW10FD)	4	GPE 81
	NEW 2.0 BlueHDi 180	1997	130	04.2016		AHH (DW10FC)	4	GPE 81
JUMPY (UGU)	1.9 D	1905	51	10.1995	04.1998	D9B (XUD9A/U)	4	G 41
	1.9 D 70	1868	51	04.1998		WJZ, WJY (DW8)	4	G 34
	1.9 TD	1905	66	10.1995		DHX (XUD9TF/BTF)	4	G 41
	1.9 TD	1905	68	04.1996		D8B (XUD9TF)	4	G 41
	2.0 HDi 95	1997	69	10.1999		RHX (DW10BTED)	4	G 57
	2.0 HDi 110	1997	80	03.2000		RHZ, RHW (DW10ATED)	4	G 57
JUMPY Camionette	1.6 HDi 90	1560	66	01.2007		9HU (DV6UTED4)	4	G 72
	2.0 HDi 120	1997	88	01.2007		RHK (DW10UTED4)	4	G 30
	2.0 HDi 140	1997	100	01.2007		RHR (DW10BTED4)	4	G 30
	NEW 2.0 HDi 95	1997	72	07.2011		AHY (DW10CE)	4	GPE 81
	NEW 2.0 HDi 125	1997	94	07.2011		AHZ (DW10CD)	4	GPE 81
	NEW 2.0 HDi 165	1997	120	07.2010		RHH (DW10CTED4)	4	GPE 81
	NEW 1.6 BlueHDi 95	1560	70	04.2016		BHV-BHS (DV6FDU)	4	GPE 81
	NEW 1.6 BlueHDi 115	1560	85	04.2016		BHX (DV6FCU)	4	GPE 81
	NEW 2.0 BlueHDi 120	1997	90	04.2016		AHK-AHJ (DW10FE)	4	GPE 81
	NEW 2.0 BlueHDi 150	1997	110	04.2016		AHX-AHR (DW10FD)	4	GPE 81
	NEW 2.0 BlueHDi 180	1997	130	04.2016		AHH (DW10FC)	4	GPE 81
JUMPY Camionette (BS_, BT_, BY_, BZ_)	1.9 D	1905	51	10.1995	08.1998	D9B (XU9DA/U)	4	G 41
	1.9 D 70	1868	51	04.1998		WJZ (DW8)	4	G 34
	1.9 TD	1905	66	10.1995		DHX (XUD9TF/BTF)	4	G 41
	2.0 HDi 95	1997	69	10.1999		RHX (DW10BTED)	4	G 57
	2.0 HDi 110	1997	80	01.2002		RHZ, RHW (DW10ATED)	4	G 57
JUMPY Camion/Plate-forme (BU_, BV_, BW_, BX_)	1.9 TD	1905	68	10.1999		D8B (XUD9TF)	4	G 41
	2.0 HDi 95	1997	69	10.1999		RHX (DW10BTED)	4	G 57
	2.0 HDi 110	1997	80	12.2003	10.2006	RHZ (DW10ATED), RHW (DW10ATED4)	4	G 57
JUMPY Camion/Plate-forme	NEW 1.6 BlueHDi 95	1560	70	09.2016		BHV-BHS (DV6FDU)	4	GPE 81
	NEW 2.0 BlueHDi 120	1997	90	09.2016		AHK (DW10FE)	4	GPE 81
	NEW 2.0 BlueHDi 150	1997	110	09.2016		AHX (DW10FD)	4	GPE 81
NEMO Camionette (AA_)	NEW 1.3 HDi	1248	55	10.2010		FHZ (F13DTE5)	4	GPE 80
	1.4 HDi	1398	50	02.2008		8HS (DV4TD)	4	G 72
NEMO Kombi	NEW 1.3 HDi	1248	55	10.2010		FHZ (F13DTE5)	4	GPE 80
	1.4 HDi	1399	50	04.2009		8HS (DV4TD)	4	G 72
SAXO (S0, S1)	1.5 D	1527	40	09.1996	09.2003	VJY (TUD5)	4	G 34
	1.5 D	1527	42	09.1996	06.2001	VJZ (TUD5)	4	G 34
	1.5 D	1527	43	07.2001	04.2004		4	G 34
SPACETOURER	NEW 1.6 BlueHDi 95	1560	70	04.2016		BHV-BHS (DV6FDU)	4	GPE 81
	NEW 1.6 BlueHDi 115	1560	85	04.2016		BHX (DV6FCU)	4	GPE 81
	NEW 2.0 BlueHDi 120	1997	90	04.2016		AHK-AHJ (DW10FE)	4	GPE 81
	NEW 2.0 BlueHDi 150	1997	110	04.2016		AHX-AHR (DW10FD)	4	GPE 81
	NEW 2.0 BlueHDi 180	1997	130	04.2016		AHH (DW10FC)	4	GPE 81
VISA	17 D	1769	44	04.1984	03.1991	161A (XUD7)	4	G 41
XANTIA (X1)	1.9 D	1905	51	06.1994	01.1998	D9B (XUD9A/L)	4	G 41

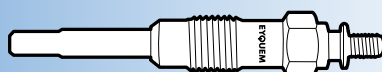



kW



Cyl.



CITROËN

	1.9 D	1905	50	06.1994	01.1998	DJZ (XUD9Y)	4	G 41	
	1.9 SD	1905	55	02.1996	01.1998	DHW (XUD9SD)	4	G 41	
	1.9 Turbo D	1905	66	10.1994	01.1998	DHX (XUD9TF/BTF)/DHY (XUD9TE/Y)	4	G 41	
XANTIA (X2)	2.1 Turbo D 12V	2088	80	06.1995	01.1998	P8C (XUD11BTE)	4	G 41	
	1.9 SD	1905	55	01.1998	04.2003	DHW (XUD9SD)	4	G 41	
	1.9 Turbo D	1905	66	01.1998	04.2003	DHX (XUD9TF/BTF)/DHY (XUD9TE/Y)	4	G 41	
	2.0 HDI 90	1997	66	03.1999	04.2003	RHY (DW10TD)	4	G 57	
	2.0 HDI 109	1997	80	02.1999	04.2003	RHZ (DW10ATED)	4	G 57	
	2.1 Turbo D 12V	2088	80	01.1998	02.1999	P8C (XUD11BTE)	4	G 41	
XANTIA Break (X1)	1.9 SD	1905	55	04.1997	01.1998	DHW (XUD9SD)	4	G 41	
	1.9 Turbo D	1905	66	06.1995	01.1998	DHX (XUD9TF/BTF)/DHY (XUD9TE/Y)/D8B (XUD9TF)	4	G 41	
	2.1 Turbo D 12V	2088	80	06.1996	01.1998	P8C (XUD11BTE)	4	G 41	
XANTIA Break (X2)	1.9 SD	1905	55	01.1998	04.2003	DHW (XUD9SD)	4	G 41	
	1.9 Turbo D	1905	66	01.1998	04.2003	DHX (XUD9TF/BTF)/D8B (XUD9TF)	4	G 41	
	2.0 HDI 90	1997	66	03.1999	04.2003	RHY (DW10TD)	4	G 57	
	2.0 HDI 109	1997	80	02.1999	04.2003	RHZ (DW10ATED)	4	G 57	
	2.1 Turbo D 12V	2088	80	01.1998	02.1999	P8C (XUD11BTE)	4	G 41	
XM (Y3)	2.1 D 12V	2138	60	05.1989	06.1994	P9A (XUD11A)	4	G 41	
	2.1 TD 12V	2088	80	05.1994	10.2000	PJZ (XUD11ATE)/P8A (XUD11ATE)/ P8C (XUD11BTE)/PHZ (XUD11ATE)	4	G 41	
XM Break (Y3)	2.5 TD	2446	95	05.1994	10.2000	THY (DK5ATE)	4	G 41	
	2.1 D 12V	2138	60	11.1991	04.1994	P9A (XUD11A)	4	G 41	
	2.1 TD 12V	2088	80	11.1991	04.1994	PJZ (XUD11ATE)/P8A (XUD11ATE)/ P8C (XUD11BTE)/PHZ (XUD11ATE)	4	G 41	
XM Break (Y4)	2.1 D12	2138	60	07.1994	06.1996	P9A (XUD11A)	4	G 41	
	2.1 TD 12V	2088	80	05.1994	10.2000	PJZ (XUD11ATE)/P8C (XUD11BTE)/ PHZ (XUD11ATE)	4	G 41	
XSARA (N1)	2.5 TD	2446	95	05.1994	10.2000	THY (DK5ATE)	4	G 41	
	1.4 HDi	1398	50	01.2003	03.2005	8HX (DV4TD)	4	G 6	
	1.5 D	1527	42	04.1997	09.2000	VJZ (TUD5)	4	G 41	
	1.8 D	1769	43	04.1997	09.2000	A9A (XUD7)/161A (XUD7)	4	G 41	
	1.8 TD	1761	66	10.1997	09.2000		4	G 41	
	1.9 D	1905	50	04.1997	09.2000	DJY (XUD9A)	4	G 41	
	1.9 D	1868	51	07.1998	03.2005	WJY (DW8B)/WJZ (DW8)	4	G 34	
	1.9 SD	1905	55	01.1998	09.2000	DHV (XUD9BSD)	4	G 41	
	1.9 TD	1905	66	04.1997	09.2000	DHY (XUD9TE/Y)	4	G 41	
	2.0 HDi 90	1997	66	02.1999	03.2005	RHY (DW10TD)	4	G 57	
	2.0 HDi 109	1997	80	05.2001	03.2005	RHZ (DW10ATED)	4	G 57	
	XSARA Break (N2)	1.4 HDi	1398	50	01.2003	08.2005	8HX (DV4TD)	4	G 6
		1.5 D	1527	42	10.1997	09.2000	VJZ (TUD5)	4	G 41
1.8 D		1769	43	10.1997	09.2000	A9A (XUD7)	4	G 41	
1.9 D		1905	50	10.1997	09.2000	DJY (XUD9A)	4	G 41	
1.9 D		1905	55	01.1998	09.2000	DHV (XUD9BSD)	4	G 41	
1.9 D		1868	51	07.1998	08.2005	WJY (DW8B)/WJZ (DW8)	4	G 34	
1.9 TD		1905	66	10.1997	09.2000	DHY (XUD9TE/Y)	4	G 41	
2.0 HDi 90		1997	66	02.1999	08.2005	RHY (DW10TD)	4	G 57	
2.0 HDi 109		1997	80	05.2001	08.2005	RHZ (DW10ATED)	4	G 57	
XSARA Coupe (N0)		1.4 HDi	1398	50	01.2003	03.2005	8HX (DV4TD)	4	G 6
		1.9 D	1905	50	02.1998	09.2000	DJY (XUD9A)	4	G 41
		1.9 D	1868	51	02.1999	03.2005	WJY (DW8B)/WJZ (DW8)	4	G 34
		1.9 TD	1905	66	02.1998	09.2000	DHY (XUD9TE/Y)	4	G 41
	2.0 HDi 90	1997	66	02.1999	03.2005	RHY (DW10TD)	4	G 57	
2.0 HDi 109	1997	80	05.2001	03.2005	RHZ (DW10ATED)	4	G 57		
XSARA Kasten	2.0 HDi	1997	66	09.2000	03.2005	RHY (DW10TD)	4	G 57	
XSARA PICASSO (N68)	1.6 HDi	1560	66	09.2005	02.2006	9HX (DV6ATED4)	4	G 6	
	1.6 HDi	1560	66	03.2006		9HX (DV6ATED4)	4	G 72	
	1.6 HDi	1560	80	05.2004	02.2006	9HZ, 9HY (DV6TED4)	4	G 6	
	1.6 HDi	1560	80	03.2006		9HZ, 9HY (DV6TED4)	4	G 72	
	2.0 HDi	1997	66	12.1999		RHY (DW10TD)	4	G 57	
	2.0 HDi	1997	66	12.1999		RHZ (DW10ATED)	4	G 57	
	ZX (N2)	1.4 D	1360	37	07.1994	10.1997		4	G 35
1.8 D		1769	44	06.1993	06.1997	161A (XUD7)	4	G 41	
1.9 D		1905	47	03.1991	06.1997	DJZ (XUD9Y)	4	G 41	
1.9 D		1905	47	03.1991	06.1997	DJZ (XUD9Y)	4	G 41	
1.9 D		1905	50	06.1994	06.1997	D9B (XUD9A/U)/DJY (XUD9A)	4	G 41	

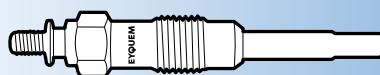



kW



Cyl.



CITROËN

	1.9 DT	1905	65	07.1994	10.1997		4	G 41
	1.9 DT	1905	68	06.1992	06.1994		4	G 41
	1.9 TD	1905	66	07.1992	06.1997	DHY (XUD9TE/Y)	4	G 41
ZX Break (N2)	1.8 D	1769	44	10.1993	10.1997	161A (XUD7)	4	G 41
	1.9 D	1905	47	10.1993	10.1997	DJZ (XUD9Y)	4	G 41
	1.9 D	1905	50	06.1994	10.1997	D9B (XUD9A/U)	4	G 41
	1.9 TD	1905	66	10.1993	10.1997	DHY (XUD9TE/Y)	4	G 41

DACIA

DOKKER	NEW 1.5 dCi	1461	55	11.2012		K9K 612	4	GPE 78
	NEW 1.5 dCi	1461	66	11.2012		K9K 612	4	GPE 78
DOKKER EXPRESS	NEW 1.5 dCi	1461	55	12.2012		K9K 612	4	GPE 78
	NEW 1.5 dCi	1461	66	12.2012		K9K 612	4	GPE 78
DUSTER	1.5 dCi	1461	63	04.2010		K9K 796	4	G 28
	NEW 1.5 dCi	1461	66	10.2010		K9K 892	4	GPE 78
	NEW 1.5 dCi	1461	79	06.2010		K9K 896	4	GPE 78
	NEW 1.5 dCi	1461	80	08.2013		K9K 856	4	GPE 78
	NEW 1.5 dCi 4x4	1461	81	10.2010		K9K 898	4	GPE 78
	NEW 1.5 dCi 4x4	1461	80	08.2013		K9K 858	4	GPE 78
	NEW 1.5 dCi 4x4	1461	79	06.2010		K9K 898	4	GPE 78
	NEW 1.5 dCi 4x4	1461	66	10.2010		K9K 894	4	GPE 78
DUSTER Box	NEW 1.5 dCi, 4x4	1461	66	04.2011		K9K 884-K9K 892	4	GPE 78
	NEW 1.5 dCi	1461	80	04.2013		K9K 856-K9K 666	4	GPE 78
	NEW 1.5 dCi, 4x4	1461	80	04.2013		K9K 858-K9K 658	4	GPE 78
LODGY	NEW 1.5 dCi	1461	66	03.2012		K9K 612	4	GPE 78
	NEW 1.5 dCi	1461	79	01.2013		K9K 846	4	GPE 78
	NEW 1.5 dCi	1461	80	06.2015		K9K 666	4	GPE 78
	NEW 1.5 dCi	1461	81	03.2012		K9K 846	4	GPE 78
LOGAN (LS_)	1.5 dCi (LS0J, LS0Y)	1461	48	09.2005		K9K 790	4	G 28
	1.5 dCi (LS0K)	1461	50	01.2006		K9K 792	4	G 28
	1.5 dCi (LS0W)	1461	63	09.2007		K9K 796	4	G 28
	NEW 1.5 dCi (LS04)	1461	55	11.2010		K9K 892	4	GPE 78
LOGAN II	NEW 1.5 dCi	1461	55	10.2012		K9K 612	4	GPE 78
	NEW 1.5 dCi	1461	63	01.2013		K9K 830	4	GPE 78
	NEW 1.5 dCi	1461	66	10.2012		K9K 612	4	GPE 78
LOGAN EXPRESS (FS_)	1.5 dCi (FS0K)	1461	50	03.2009		K9K 792	4	G 28
	1.5 dCi (FS0W)	1461	63	03.2009		K9K 796	4	G 28
	NEW 1.5 dCi (FS)	1461	55	05.2010		K9K 892	4	GPE 78
	NEW 1.5 dCi (FS)	1461	65	05.2010		K9K 892	4	GPE 78
LOGAN MCV (KS_)	1.5 dCi (KS0K)	1461	50	02.2007		K9K 792	4	G 28
	NEW 1.5 dCi (KS)	1461	55	05.2010		K9K 892	4	GPE 78
	1.5 dCi (KS0W)	1461	63	09.2007		K9K 796	4	G 28
	NEW 1.5 dCi (KS)	1461	65	05.2010		K9K 892	4	GPE 78
LOGAN MCV II	NEW 1.5 dCi	1461	55	02.2013		K9K 612	4	GPE 78
	NEW 1.5 dCi	1461	63	02.2013		K9K 830	4	GPE 78
	NEW 1.5 dCi	1461	66	02.2013		K9K 612	4	GPE 78
LOGAN Pick-up (US_)	1.5 dCi (US0K)	1461	50	03.2008		K9K 792	4	G 28
	1.5 dCi (US0W)	1461	63	03.2008		K9K 796	4	G 28
	NEW 1.5 dCi	1461	55	05.2010		K9K 892	4	GPE 78
	NEW 1.5 dCi	1461	65	05.2010		K9K 892	4	GPE 78
SANDERO	1.5 dCi	1461	50	11.2008		K9K 792	4	G 28
	1.5 dCi	1461	63	11.2008		K9K 796	4	G 28
	NEW 1.5 dCi	1461	55	05.2010		K9K 892	4	GPE 78
	NEW 1.5 dCi	1461	65	05.2010		K9K 892	4	GPE 78
SANDERO II	NEW 1.5 dCi	1461	55	10.2012		K9K 612	4	GPE 78
	NEW 1.5 dCi	1461	66	10.2012		K9K 612	4	GPE 78
SOLENZA	1.9 D	1870	46	02.2003		F8Q 630	4	G 29

DAEWOO

KORANDO (KJ)	2.9 D	2874	72	01.1999		MB-OM 662	5	G 24
	2.9 TD	2874	88	01.1999		MB-OM 601 29TD	5	G 24
KORANDO Cabrio (KJ)	2.9 D	2874	72	02.1999		MB-OM 662	5	G 24
	2.9 TD	2874	88	02.1999		MB-OM 601 29TD	5	G 24
MUSSO (FJ)	2.2 TD	2299	74	09.1999		MB OM 601	4	G 24
	2.9 D 4x4	2874	73	01.1999	09.1999	MB-OM 662	5	G 24

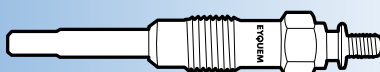



kW



Cyl.



DAEWOO

	2.9 TD 4x4	2874	88	01.1999		MB-OM 601 29TD	5	G 24
REXTON (GAB_)	2.9 TD	2874	88	04.2002			5	G 24

DAF

400-Serie Camionnette	428-435 2.5 D	2498	53	04.1989	08.1993	EN 55	4	G 41
	428-435 2.5 TD	2498	71	04.1989	08.1993	ET 70	4	G 41

DAIHATSU

CHARADE II (G11, G30)	1.0 D (G30)	993	27	10.1983	03.1987	CL 10	3	G 14
	1.0 TD (G30)	993	34	02.1985	03.1987	CL 60	3	G 14
ROCKY Hard Top (F7, F8)	2.8 D	2765	54	02.1985		DL	4	G 14
	2.8 TD	2765	75	09.1991		DL 52	4	G 14
	2.8 TD	2765	67	12.1987	04.1993	DL 51	4	G 14
	2.8 TD	2765	72	05.1993		DL 52	4	G 14
ROCKY Soft Top (F7, F8)	2.8 D	2765	54	02.1985		DL	4	G 14
	2.8 TD	2765	75	09.1991		DL 52	4	G 14
	2.8 TD	2765	67	12.1987	04.1993	DL 51	4	G 14
WILDCAT/ROCKY (F70)	2.8 D	2765	54	02.1985	03.1987	DL	4	G 14
	2.8 TD	2765	65	09.1985	04.1987	DL 50	4	G 14
WILDCAT/ROCKY (F75)	2.8 D	2765	54	02.1985	03.1987	DL	4	G 14
	2.8 TD	2765	65	09.1985	04.1987	DL 50	4	G 14

DS

DS 3	NEW 1.6 BlueHDi 75	1560	55	07.2015		BHW (DV6FE)	4	GPE 81
	NEW 1.6 BlueHDi 100	1560	73	04.2015		BHY (DV6FD)	4	GPE 81
	NEW 1.6 BlueHDi 120	1560	88	07.2015		BHZ (DV6FC)	4	GPE 81
DS 3 Cabrio	NEW 1.6 BlueHDi 100	1560	73	07.2015		BHY (DV6FD)	4	GPE 81
	NEW 1.6 BlueHDi 120	1560	88	07.2015		BHZ (DV6FC)	4	GPE 81
DS 4 / DS4 CROSSBACK	NEW 1.6 BlueHDi 100	1560	73	04.2016		BHY (DV6FD)	4	GPE 81
	NEW 1.6 BlueHDi 120	1560	88	07.2015		BHZ (DV6FC)	4	GPE 81
	NEW 2.0 BlueHDi 150	1997	110	07.2015		AHR (DW10FD)	4	GPE 81
	NEW 2.0 BlueHDi 180	1997	133	07.2015		AHW (DW10FC)	4	GPE 81
DS5	NEW 1.6 BlueHDi 115	1560	85	06.2015		BHX (DV6C)	4	GPE 81
	NEW 1.6 BlueHDi 120	1560	88	07.2015		BHZ (DV6FC)	4	GPE 81
	NEW 2.0 BlueHDi 150	1997	110	05.2015		AHR (DW10FD)	4	GPE 81
	NEW 2.0 HDi 165 Hybrid4 4x4	1997	120	04.2015		RHC (DW10CTED4)	4	GPE 81
	NEW 2.0 BlueHDi 180	1997	133	04.2015		AHW (DW10FC)	4	GPE 81
DS7 Crossback	NEW 2.0 BlueHDi 180	1997	133	09.2017		EHZ (DW10FC)	4	GPE 81

FIAT

127	1.3 Diesel	1301	33	04.1981	12.1986	127 A5.000	4	G 41
131	2.0 D	1995	44	07.1978	08.1984	8144.65	4	G 41
	2.5 Diesel	2445	53	06.1978	02.1984	8144.61	4	G 41
	2.0 D	1995	44	07.1978	08.1984	8144.65	4	G 41
131 Familiare/Panorama	2.5 Super Diesel (AF)	2445	53	03.1979	12.1984	8144.61	4	G 41
	2.0 D	1995	44	07.1978	07.1982	8144.65	4	G 41
132	2.5 D	2445	53	07.1978	07.1982	8144.61	4	G 41
	1.3 D	1301	33	07.1982	07.1983	127 A5.000	4	G 41
147	1.3 D	1301	36	10.1980	10.1995		4	G 41
147 Panorama	1.3 D	1301	33	07.1982	07.1983	127 A5.000	4	G 41
242-SERIE Camionnette	2.5 D	2482	52	08.1980	07.1982		4	G 41
500	1.3 D Multijet	1248	55	10.2007		169 A1.000	4	G 7
	NEW 1.3 D Multijet	1248	70	12.2009		199 B1.000	4	GPE 80
500 C	1.3 D Multijet	1248	55	09.2009		169 A1.000	4	G 7
	NEW 1.3 D Multijet	1248	70	09.2009		199 B1.000	4	GPE 80
500 L	NEW 1.3 D Multijet	1248	62	09.2012		199 B4.000	4	GPE 80
	NEW 1.6 D Multijet	1248	77	09.2012		199 B5.000	4	GPE 82
	NEW 1.6 D Multijet	1248	88	09.2013		955 A3.000	4	GPE 82
	ARGENTA (132A)	2500 Diesel	2445	53	06.1981	11.1985	8144.61	4
	2500 Turbodiesel	2445	66	07.1983	08.1985	8144.61.500.81	4	G 41
BRAVA (182)	1.9 D	1929	48	10.1995	10.2001	160 A7.000	4	G 41
	1.9 JTD	1910	74	09.2000	10.2001	182 B9.000	4	G 60
	1.9 JTD 105	1910	77	12.1998	10.2001	182 B4.000	4	G 60
	1.9 TD 100 S (182.BF)	1910	74	03.1996	10.2001	182 A7.000	4	G 39
	1.9 TD 75 S (182.BF)	1910	55	03.1996	10.2001	182 A8.000	4	G 39





kW



Cyl.



FIAT

BRAVO I (182)	1.9 D	1929	48	10.1995	10.2001	160 A7.000	4	G 41	
	1.9 JTD	1910	74	09.2000	10.2001	182 B9.000	4	G 60	
	1.9 JTD 105	1910	77	12.1998	10.2001	182 B4.000	4	G 60	
	1.9 TD 100 S (182.AF)	1910	74	03.1996	10.2001	182 A7.000	4	G 39	
	1.9 TD 75 S (182.AF)	1910	55	03.1996	10.2001	182 A8.000	4	G 39	
BRAVO II (198)	NEW 1.6 D Multijet	1598	77	03.2008		198 A3.000	4	GPE 82	
	NEW 1.6 D Multijet	1598	85	11.2008		955 A4.000	4	GPE 82	
	NEW 1.6 D Multijet	1598	88	03.2008		198 A2.000	4	GPE 82	
	NEW 1.9 D Multijet	1910	66	04.2007	12.2008	192 B5.000	4	G 89	
	NEW 1.9 D Multijet	1910	85	11.2006		192 A1.000/192 B4.000	4	G 89	
	NEW 1.9 D Multijet	1910	88	04.2007		192 A8.000	4	G 89	
	1.9 D Multijet	1910	110	04.2007		937 A5.000	4	G 8	
	NEW 2.0 D Multijet	1956	120	09.2008		844 A2.000	4	GPE 82	
	NEW 2.0 D Multijet	1956	121	09.2008		198 A5.000	4	GPE 82	
CAMPAGNOLA	2.4 D	2445	53	06.1974	10.1989	8144.61.200	4	G 41	
CROMA (154)	1900 Turbo D i.d.	1929	69	11.1992	12.1996	154 D1.000	4	G 10	
	1900 Turbo D i.d. (154.LL, 154.PL)	1929	66	05.1989	10.1992	154 C6.000	4	G 10	
	2500 D	2499	55	12.1985	12.1989	8144.67	4	G 41	
	2500 TD (154.AE)	2445	74	12.1985	08.1989	8144.91.2000	4	G 41	
	2500 TD (154.LL, 154.PL)	2500	85	05.1989	08.1996	8144.97/8144.97 Y/8144.97.2400	4	G 41	
CROMA (194)	2500 TDE	2500	77	12.1991	08.1996	8144.97 S	4	G 41	
	1.9 D Multijet	1910	85	06.2005		939 A7.000	4	G 60	
	NEW 1.9 D Multijet	1910	85	06.2005		939 A7.000	4	G 89	
	NEW 1.9 D Multijet	1910	88	06.2005		939 A1.000	4	G 89	
	1.9 D Multijet	1910	110	06.2005		939 A2.000	4	G 8	
DOBLO (119)	2.4 D Multijet	2387	147	06.2005		939 A3.000	5	G 8	
	1.3 D Multijet	1248	62	10.2005		223 A9.000	4	G 7	
	1.3 JTD	1248	55	05.2005		199 A2.000	4	G 7	
	1.9 D (223AXB1A)	1910	46	03.2001		223 A6.000	4	G 59	
	1.9 JTD	1910	77	07.2003		223 B1.000/223 A7.000	4	G 60	
DOBLO (152)	1.9 JTD (223AXE1A)	1910	74	10.2001		182 B9.000/223 B2.000	4	G 60	
	NEW 1.9 D Multijet	1910	88	10.2005		186 A.9000	4	G 89	
	1.3 D Multijet	1248	66	02.2010		263 A2.000/199 A3.000	4	G 7	
	DOBLO Cargo (223)	1.3 D Multijet	1248	55	10.2005		199 A2.000	4	G 7
	1.3 JTD 16V	1248	51	05.2004		188 A9.000	4	G 7	
DOBLO Cargo (263)	1.9 D (223ZXB1A)	1910	46	03.2001		223 A6.000	4	G 59	
	1.9 JTD	1910	77	07.2003		223 B1.000/223 A7.000	4	G 60	
	1.9 JTD (223ZXE1A)	1910	74	10.2001		182 B9.000	4	G 60	
	NEW 1.9 JTD Multijet	1910	88	12.2006	12.2010	186 A9.000	4	G 89	
	NEW 1.3 D Multijet	1248	66	02.2010		263 A2.000/199 A3.000	4	GPE 80	
DOBLO Camionnette (263)	NEW 1.6 D Multijet	1588	66	02.2010		263 A4.000	4	GPE 82	
	NEW 1.6 D Multijet	1588	74	02.2011		263 A3.000	4	GPE 82	
	NEW 1.6 D Multijet	1588	77	02.2010		198 A3.000	4	GPE 82	
	NEW 2.0 D Multijet	1956	99	02.2010		263 A1.000	4	GPE 82	
	NEW 1.3 D Multijet	1248	66	02.2010		263 A2.000/199 A3.000	4	GPE 80	
DOBLO Monospace (263)	NEW 1.6 D Multijet	1588	66	02.2010		263 A4.000	4	GPE 82	
	NEW 1.6 D Multijet	1588	74	02.2010		263 A3.000	4	GPE 82	
	NEW 1.6 D Multijet	1588	77	02.2010		198 A3.000	4	GPE 82	
	NEW 2.0 D Multijet	1956	99	02.2010		263 A1.000	4	GPE 82	
	NEW 1.3 D Multijet	1248	66	02.2010		263 A2.000/199 A3.000	4	GPE 80	
DUCATO Bus (230)	NEW 1.6 D Multijet	1588	66	02.2010		263 A4.000	4	GPE 82	
	NEW 1.6 D Multijet	1588	74	02.2010		263 A3.000	4	GPE 82	
	NEW 1.6 D Multijet	1588	77	02.2010		198 A3.000	4	GPE 82	
	NEW 2.0 D Multijet	1956	99	02.2010		263 A1.000	4	GPE 82	
	1.9 D	1905	50	04.1998	04.2002	D9B/DJY/D9B (XUD9A)	4	G 41	
	1.9 D Combinato	1929	51	06.1995	04.2002	230 A2.000	4	G 41	
	1.9 TD	1905	66	04.1998	04.2002	DHX (XUD9TF/L)	4	G 41	
	1.9 TD Combinato	1929	59	08.1994	04.2002	230 A4.000	4	G 41	
	1.9 TD Panorama/Combinato	1929	60	03.1994	04.2002	230 A3.000	4	G 41	
DUCATO Bus (244, Z_)	1.9 TD Panorama/Combinato	1929	60	03.1994	04.2002	230 A3.000	4	G 41	
	2.0 JTD	1997	62	10.2001	04.2002	RHV (DW10)	4	G 57	
	2.5 D Combinato	2500	62	08.1994	04.2002	8140.67	4	G 35	
	2.8 D	2800	64	02.1998	04.2002	8140.63	4	G 62	
	2.0 JTD	1997	62	04.2002		RHV (DW10)	4	G 57	
DUCATO Bus (244, Z_)	2.3 JTD	2286	81	04.2002		F1AE0481C	4	G 9	
	2.3 JTD	2287	93	12.2009		F1AE0481T	4	G 9	

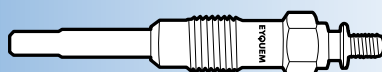



kW



Cyl.



FIAT

DUCATO Bus (250)	NEW 2.0 D Multijet	1956	85	06.2011		250 A1.000	4	GPE 82
	120 Multijet 2,3 D	2287	88	07.2006		F1AE0481D	4	G 9
	130 Multijet 2,3 D	2287	96	01.2007		F1AE3481D	4	G 9
	150 Multijet 2,3 D	2287	109	06.2011		F1AE3481E	4	G 9
	150 Multijet 3,0 D	2999	107	04.2010		F1CE3481N	4	G 9
	160 Multijet 3,0 D	2999	116	07.2006		F1CE0481D	4	G 9
	3.0 D Multijet	2999	130	06.2011		F1CE3481E	4	G 9
DUCATO Camionnette (230L)	1.9 D	1929	51	03.1994	04.2002	230 A2.000	4	G 41
	1.9 D	1905	50	04.1998	04.2002	DJY	4	G 41
	1.9 D	1929	51	03.1994	04.2002	230 A2.000	4	G 41
	1.9 TD	1929	60	03.1994	04.2002	230 A3.000	4	G 41
	1.9 TD	1905	66	04.1998	04.2002	DHX (XUD9TF/L)	4	G 41
	1.9 TD	1929	60	03.1994	04.2002	230 A3.000	4	G 41
	1.9 TD CAT	1929	59	08.1994	04.2002	230 A4.000	4	G 41
	2.0 JTD	1997	62	10.2001	04.2002	RHV (DW10)	4	G 57
	2.5 D	2500	62	03.1994	04.2002	8140.67	4	G 35
	2.8 D	2800	64	05.1998	04.2002	8140.63	4	G 62
	2.8 D 4x4	2800	64	08.1998	04.2002	8140.63	4	G 62
DUCATO Camionnette (244)	2.0 JTD	1997	62	04.2002		RHV (DW10)	4	G 57
	2.3 JTD	2286	81	04.2002		F1AE0481C	4	G 9
	2.3 JTD	2287	93	12.2009		F1AE0481T	4	G 9
	2.8 JTD Power	2800	107	05.2004		8140.43N	4	G 58
DUCATO Camionnette (250)	NEW 115 Multijet 2.0 D	1956	85	06.2011		250 A1.000	4	GPE 82
	120 Multijet 2,3 D	2287	88	07.2006		F1AE0481D	4	G 9
	130 Multijet 2,3 D	2287	96	01.2007		F1AE0481N/F1AE3481D	4	G 9
	150 Multijet 2,3 D	2287	109	06.2011		F1AE3481E	4	G 9
	150 Multijet 3,0 D	2999	107	04.2010		F1CE3481N	4	G 9
	160 Multijet 3,0 D	2999	116	07.2006		F1CE0481D	4	G 9
	3.0 D Multijet	2999	130	06.2011		F1CE3481E	4	G 9
DUCATO Camionnette (280)	1.9 D	1929	52	01.1988	08.1990	149 B1.000	4	G 41
	1.9 TD	1929	60	03.1989	08.1990	280 A1.000	4	G 41
	2.4 D	2428	53	01.1982	08.1990	8144.61	4	G 41
	2.4 D 4x4	2445	55	09.1986	05.1990	8144.61	4	G 41
	2.5 D	2500	55	01.1982	08.1990	CRD93L (U25-661)/8144.67	4	G 41
	2.5 D 4x4	2500	55	03.1989	08.1990	8144.67	4	G 41
	2.5 TD 4x4	2499	70	09.1986	05.1990	8140.27	4	G 41
DUCATO Camionnette (290)	1.9 D	1929	52	07.1990	03.1994	149 B1.000	4	G 41
	1.9 TD	1929	60	03.1989	03.1994	280 A1.000	4	G 41
	2.5 D 4x4	2500	55	07.1990	03.1994	8144.67	4	G 41
	2.5 TD	2500	70	07.1990	03.1994	8140.27	4	G 41
	2.5 TD 4x4	2500	70	07.1990	03.1994	8140.27	4	G 41
DUCATO Panorama (280)	1.9 D	1929	52	02.1987	08.1990	149 B1.000	4	G 41
	1.9 TD	1929	60	03.1989	08.1990	280 A1.000	4	G 41
	2.4 D	2428	53	07.1982	12.1985	8144.61	4	G 41
	2.4 TD	2445	68	01.1987	08.1990	8144.21.220/8144.21	4	G 41
	2.4 TD 4x4	2445	68	01.1986	08.1990	8144.21	4	G 41
	2.5 D	2500	55	01.1986	08.1990	CRD93L (U25-661)/8144.67	4	G 41
	2.5 D 4x4	2500	55	01.1987	08.1990	8144.67	4	G 41
DUCATO Panorama (290)	1.9 D	1929	52	07.1990	03.1994	149 B1.000	4	G 41
	1.9 TD	1929	60	07.1990	03.1994	280 A1.000	4	G 41
	2.5 D	2500	55	07.1990	03.1994	8144.67	4	G 41
	2.5 TD	2500	70	08.1990	03.1994	8140.27	4	G 41
	2.5 TD 4x4	2499	70	06.1990	05.1994	8140.27	4	G 41
DUCATO Camion/Plate-forme (230)	1.9 D	1929	51	03.1994	04.2002	230 A2.000	4	G 41
	1.9 D	1905	50	04.1998	04.2002	DJY	4	G 41
	1.9 TD	1929	60	03.1994	04.2002	230 A3.000	4	G 41
	1.9 TD	1905	66	04.1998	04.2002	DHX (XUD9TF/L)	4	G 41
	1.9 TD	1929	60	03.1994	04.2002	230 A3.000	4	G 41
	1.9 TD	1905	66	04.1998	04.2002	DHX (XUD9TF/L)	4	G 41
	1.9 TD CAT	1929	59	08.1994	04.2002	230 A4.000	4	G 41
	2.5 D	2500	62	03.1994	04.2002	8140.67	4	G 35
	2.5 D 4x4	2500	62	03.1994	04.2002	8140.67	4	G 35
	2.8 D	2800	64	02.1998	04.2002	8140.63	4	G 62
	2.8 TD 4x4	2799	64	05.1998	11.2001	8140.63	4	G 62
DUCATO Camion/Plate-forme (244)	2.0 JTD	1997	62	04.2002		RHV (DW10)	4	G 57





kW



Cyl.



FIAT

	2.3 JTD	2287	93	12.2009		F1AE0481T	4	G 9
	2.8 JTD Power	2800	107	05.2004		8140.43N	4	G 58
DUCATO Camion/Plate-forme (250)	120 Multijet 2,3 D	2287	88	07.2006		F1AE0481D	4	G 9
	130 Multijet 2,3 D	2287	96	01.2007		F1AE0481N/F1AE3481D	4	G 9
	150 Multijet 2,3 D	2287	109	06.2011		F1AE3481E	4	G 9
	150 Multijet 3,0 D	2999	107	04.2010		F1CE3481N	4	G 9
	160 Multijet 3,0 D	2999	116	07.2006		F1CE0481D	4	G 9
	3.0 D Multijet	2999	130	06.2011		F1CE3481E	4	G 9
DUCATO Camion/Plate-forme (280)	1.9 D	1929	52	01.1988	08.1990	149 B1.000	4	G 41
	1.9 TD	1929	60	03.1989	08.1990	280 A1.000	4	G 41
	2.4 TD	2445	68	01.1986	08.1990	8144.21	4	G 41
	2.5 D	2500	55	07.1982	08.1990	CRD93L (U25-661)/8144.67	4	G 41
	2.5 D 4x4	2500	55	03.1989	08.1990	8144.67	4	G 41
DUCATO Camion/Plate-forme (290)	1.9 TD	1929	60	03.1989	03.1994	280 A1.000	4	G 41
	2.5 D	2500	55	07.1990	03.1994	8144.67	4	G 41
DUNA (146 B)	DS 1.7	1698	44	01.1987	12.1991	149 B3.000	4	G 41
DUNA Weekend (146 B)	DS 1.7	1698	44	01.1987	12.1991	149 B3.000	4	G 41
ELBA (146_)	1.3 D	1301	33	04.1986	10.1992	127 A5.000	4	G 41
	1.7 D	1698	43	04.1989	12.1996	146 B2.000	4	G 41
FIORINO (147)	1.3 Diesel	1288	33	03.1982	12.1987	127 A5.000	4	G 41
	1.7 Diesel	1697	42	01.1988		149 B2.000	4	G 41
	1.7 Diesel	1698	44	12.1987	12.1990	149 B3.000	4	G 41
FIORINO Camionnette (146 Uno)	60 1.7 D	1697	42	05.1988	10.1996	146 B2.000	4	G 41
	60 1.7 D	1698	44	05.1988	05.2000	149 B3.000	4	G 41
	65 1.7 TD	1698	46	01.1997	05.2001	146 D7.000	4	G 41
FIORINO Camionnette/Kombi	1.3 D Multijet	1248	55	02.2008		199 A2.000/199 A9.000	4	G 7
FIORINO (225)	NEW 1.3 D Multijet	1248	70	07.2009		199 B1.000	4	GPE 80
FIORINO Pick up (146)	1.7 D	1697	42	10.1993	10.1999	146 B2.000	4	G 41
	1.7 D	1698	44	05.1988	10.1999	149 B3.000	4	G 41
	1.7 TD	1698	46	01.1997	05.2001	146 D7.000	4	G 41
FIORINO Pick up (147)	1.3 D	1302	33	05.1984	12.1988	127 A5.000	4	G 41
FREEMONT (JC)	NEW 2.0 JTD	1956	100	08.2011		939 B5.000	4	GPE 82
	NEW 2.0 JTD	1956	103	08.2011		939 B5.000/ 940 A5.000	4	GPE 82
	NEW 2.0 JTD	1956	120	08.2011		939 B5.000	4	GPE 82
	NEW 2.0 JTD	1956	125	08.2011		939 B5.000	4	GPE 82
GRANDE PUNTO Van (199)	1.3 D Multijet	1248	55	04.2008		199 A2.000	4	G 7
IDEA	1.3 D Multijet	1248	66	10.2005		199 A3.000	4	G 7
	NEW 1.3 D Multijet	1248	70	05.2008		199 B1.000	4	GPE 80
	NEW 1.6 D Multijet	1598	88	05.2008		350 A2.000	4	GPE 82
	1.3 JTD	1248	51	01.2004		188 A9.000	4	G 7
	1.9 JTD	1910	74	01.2004		188 B2.000	4	G 60
LINEA	1.3 D Multijet	1248	66	06.2007		199 A3.000	4	G 7
	NEW 1.6 D Multijet	1598	77	06.2009		198 A3.000	4	GPE 82
MAREA (185)	1.9 JTD 105	1910	77	04.1999	01.2001	182 B4.000	4	G 60
	1.9 JTD 110	1910	81	01.2001		186 A6.000	4	G 60
	1.9 TD 100	1910	74	09.1996		182 A7.000	4	G 39
	1.9 TD 75	1910	55	09.1996		182 A8.000	4	G 39
	2.4 JTD 130	2387	96	04.1999		839 A5.000/185 A6.000	5	G 60
	2.4 TD 125	2387	91	09.1996	04.1999	185 A2.000	5	G 39
MAREA Weekend (185)	1.9 JTD 105	1910	77	04.1999		182 B4.000	4	G 60
	1.9 JTD 110	1910	81	01.2001		186 A6.000	4	G 60
	1.9 TD 100	1910	74	09.1996		182 A7.000/182 B9.000	4	G 60
	1.9 TD 75	1910	55	09.1996		182 A8.000	4	G 39
	2.4 JTD 130	2387	96	04.1999		839 A5.000/185 A6.000	5	G 60
	2.4 TD 125	2387	91	09.1996	04.1999	185 A2.000	5	G 39
MULTIPLA (186)	NEW 1.9 JTD 115	1910	85	07.2002	06.2010	186 A8.000	4	G 89
	NEW 1.9 JTD (186AXE1A)	1910	88	04.2002	06.2010	186 A9.000	4	G 89
	1.9 JTD (186AXE1A)	1910	88	04.2002		186 A9.000	4	G 60
	1.9 JTD 105 (186AXB1A)	1910	77	04.1999		182 B4.000	4	G 60
	1.9 JTD 110	1910	81	03.2001	07.2002	186 A6.000	4	G 60
	1.9 JTD 115	1910	85	07.2002		186 A8.000	4	G 60
PALIO (178BX)	1.9 D	1910	46	09.2000		223 A6.000	4	G 59
PALIO Weekend (178DX)	1.7 TD (178DX.H1A)	1698	51	04.1996	03.2001	176 A3.000	4	G 41
	1.9 D (178DYD1A07)	1910	46	03.2001		223 A6.000	4	G 59
PANDA (141A_)	1300 D	1302	27	04.1986	12.1992	156 A5.000	4	G 41

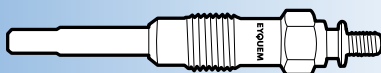



kW



Cyl.



FIAT

PANDA (169)	1.3 D Multijet	1248	51	09.2003		188 A9.000	4	G 7
	1.3 D Multijet	1248	55	06.2006		169 A1.000	4	G 7
	1.3 D Multijet 4x4	1248	51	10.2004		188 A9.000	4	G 7
PANDA Van (169)	NEW 1.3 D Multijet 4x4	1248	55	09.2010		169 A1.000/169 A5.000	4	GPE 80
	1.3 JTD	1248	51	03.2004		188 A9.000	4	G 7
	1.3 JTD	1248	55	01.2006		169 A1.000	4	G 7
PANDA (312,319)	NEW 1.3 D Multijet	1248	55	02.2012		199 A9.000	4	GPE 80
	NEW 1.3 D Multijet 4x4	1248	55	06.2012		199 A9.000	4	GPE 80
PUNTO (176)	1.7 D	1698	42	04.1994	09.1997	176 B3.000	4	G 41
	1.7 TD	1698	51	01.1994	09.1999	176 A3.000	4	G 41
	1.7 TD	1698	52	01.1994	09.1999	176 A5.000	4	G 41
	60 TD 1.7	1698	46	09.1996	09.1999	176 B7.000	4	G 41
PUNTO (188)	1.3 JTD 16V	1248	51	06.2003		188 A9.000	4	G 7
	1.9 DS 60 (188.031, .051, .231, .251)	1910	44	09.1999		188 A3.000	4	G 59
	1.9 JTD	1910	63	10.2001	09.2005	188 A7.000	4	G 60
	NEW 1.9 JTD	1910	63	10.2005		188 A.7000	4	G 89
	1.9 JTD	1910	74	06.2003	09.2005	188 B2.000	4	G 60
	NEW 1.9 JTD	1910	74	10.2005		188 B2.000	4	G 89
PUNTO / GRANDE PUNTO (199)	1.9 JTD 80 (188.237, .257, .337, .357)	1910	59	09.1999		188 A2.000	4	G 60
	1.3 D Multijet	1248	55	10.2005		199 A2.000	4	G 7
	1.3 D Multijet	1248	66	10.2005		199 A3.000	4	G 7
	NEW 1.3 D Multijet	1248	55	03.2012		199 A2.000/199 A9.000	4	GPE 80
	NEW 1.3 D Multijet	1248	59	12.2013		199 B8.000	4	GPE 80
	NEW 1.3 D Multijet	1248	62	03.2012		199 B4.000	4	GPE 80
	NEW 1.3 D Multijet	1248	70	03.2012		199 B1.000	4	GPE 80
	NEW 1.6 D Multijet	1598	88	07.2008		955 A3.000	4	GPE 82
	NEW 1.9 D Multijet	1910	85	06.2006		939 A7.000	4	G 89
	NEW 1.9 D Multijet	1910	88	10.2005		939 A1.000	4	G 89
	NEW 1.9 D Multijet	1910	96	10.2005		199 A5.000	4	G 89
	PUNTO EVO	NEW 1.3 D Multijet	1248	55	10.2009	02.2012	199 A2.000/199 A9.000	4
1.3 D Multijet		1248	62	03.2012		199 B4.000	4	G 7
NEW 1.3 D Multijet		1248	62	10.2009	02.2012	199 B4.000/223 A9.000	4	GPE 80
1.3 D Multijet		1248	70	03.2012		199 B1.000	4	G 7
NEW 1.3 D Multijet		1248	70	10.2009	02.2012	199 B1.000	4	GPE 80
NEW 1.6 D Multijet		1598	88	10.2009	02.2012	955 A3.000	4	GPE 82
PUNTO Van (176L)	1.3 D Multijet	1248	66	10.2009		199 A3.000	4	G 7
	1.7 D	1698	42	04.1996	02.2000	176 B3.000	4	G 41
	1.7 TD	1698	52	04.1996	02.2000	176 A5.000	4	G 41
PUNTO Van (188AX)	1.3 JTD	1248	51	06.2003	10.2005	188 A9.000	4	G 7
	1.9 D 60	1910	44	02.2000		188 A3.000	4	G 59
	1.9 JTD	1910	63	02.2000	07.2007	188 A7.000	4	G 60
	NEW 1.9 JTD	1910	63	08.2007	10.2009	188 A7.000	4	G 89
QUBO	1.3 D Multijet	1248	55	09.2008		199 A2.000	4	G 7
QUBO (225)	NEW 1.3 D Multijet	1248	55	02.2008		199 A2.000	4	GPE 80
	NEW 1.3 D Multijet	1248	70	07.2010		199 B1.000	4	GPE 80
REGATA (138)	60 Diesel 1.7	1698	44	05.1985	03.1989	149 B3.000	4	G 41
	60 Diesel 1.7	1714	43	09.1983	12.1986	138 B6.000	4	G 41
	65 Diesel 1.9	1929	48	04.1984	07.1989	149 A1.000	4	G 41
	80 Turbo Diesel 1.9	1929	59	05.1986	07.1989	831 D1.000	4	G 41
	REGATA Weekend	60 Diesel 1.7	1698	44	01.1984	12.1989	149 B3.000	4
REGATA Weekend	65 Diesel 1.9	1929	48	04.1984	07.1989	149 A1.000	4	G 41
	80 Turbo Diesel 1.9	1929	59	05.1986	07.1989	831 D1.000	4	G 41
	RITMO I (138A)	55 Diesel 1.7	1714	40	10.1979	09.1982	138 A5.000	4
RITMO II (138A)	55 Diesel 1.7	1714	43	10.1979	09.1982	138 A5.000	4	G 41
	60 Diesel 1.7	1714	43	10.1982	10.1985	138 B6.000	4	G 41
	60 Diesel 1.7	1698	44	05.1985	12.1987	149 B3.000/138 C.000	4	G 41
SCUDO (270_)	80 Turbo Diesel 1.9	1929	59	12.1985	12.1987	831 D1.000	4	G 41
	2.0 D Multijet	1997	88	01.2007		RHK	4	G 30
	2.0 D Multijet	1997	100	01.2007		RHR	4	G 30
SCUDO Combinato (220P)	1.9 D	1868	51	04.1998		WJZ (DW8)	4	G 34
	1.9 D	1905	51	02.1996	04.1998	D9B	4	G 41
	1.9 TD	1905	68	02.1996		D8B	4	G 41
	1.9 TD Eco	1905	66	02.1996		DHX (XUD9TF/L)	4	G 41
	2.0 JTD	1997	69	01.2004		RHX	4	G 57
	2.0 JTD	1997	80	12.1999		RHZ	4	G 57

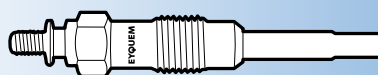



kW



Cyl.



FIAT

SCUDO Camionnette (220L)	1.9 D	1868	51	04.1998		WJZ (DW8)	4	G 34	
	1.9 D	1905	51	02.1996		D9B	4	G 41	
	1.9 TD	1905	66	02.1996		DHX (XUD9TF/L)	4	G 41	
	1.9 TD	1905	68	02.1998		D8B	4	G 41	
	2.0 JTD	1997	69	12.1999		RHX	4	G 57	
SCUDO Camionnette (270_)	2.0 D Multijet	1997	88	01.2007		RHK	4	G 30	
	2.0 D Multijet	1997	100	01.2007		RHR	4	G 30	
SCUDO Camion/Plate-forme (270_)	1.6 D Multijet	1560	66	01.2007		9HU	4	G 72	
	2.0 D Multijet	1997	88	01.2007		RHK	4	G 30	
	2.0 D Multijet	1997	100	01.2007		RHR	4	G 30	
SEDICI	1.9 D Multijet	1910	88	06.2006		D19AA	4	G 60	
	NEW 2.0 D Multijet	1956	99	06.2006		D20AA	4	GPE 82	
SIENA (178_)	1.3 JTD	1248	51	09.2003		188 A9.000	4	G 7	
	1.7 TD	1697	51	02.2006		176 A3.000	4	G 41	
	1.9 D	1910	46	11.2000		223 A6.000	4	G 59	
STILO (192)	1.9 D Multijet	1910	74	09.2005		192 A9.000	4	G 60	
	NEW 1.9 D Multijet	1910	88	09.2005	11.2006	192 A8.000	4	G 89	
	1.9 D Multijet	1910	110	09.2005		937 A5.000	4	G 8	
	1.9 JTD	1910	93	09.2003		937 A4.000	4	G 8	
	1.9 JTD	1910	103	01.2004		192 A5.000	4	G 8	
	1.9 JTD (192_XE1A)	1910	85	10.2001		192 A1.000/937 A7.000	4	G 60	
	1.9 JTD (192_XF1A)	1910	59	02.2002		192 A3.000	4	G 60	
	NEW 1.9 JTD (192_XF1A)	1910	85	10.2001	11.2006	192 A1.000/937 A7.000	4	G 89	
	NEW 1.9 JTD (192_AXS1B, BXS1B)	1910	66	09.2004	11.2006	192 B5.000	4	G 89	
	NEW 1.9 D	1910	66	10.2005	12.2007	192 B5.000	4	G 89	
	STILO Multi Wagon (192)	1.9 D Multijet	1910	74	09.2005		192 A9.000	4	G 60
NEW 1.9 D Multijet		1910	88	09.2005	08.2008	192 A8.000	4	G 89	
1.9 D Multijet		1910	110	09.2005		937 A5.000	4	G 8	
1.9 JTD		1910	85	01.2003		192 A1.000/937 A7.000	4	G 60	
NEW 1.9 JTD		1910	85	01.2003	08.2008	192 A1.000/937 A7.000	4	G 89	
1.9 JTD		1910	59	01.2003		192 A3.000	4	G 60	
1.9 JTD		1910	93	09.2003		937 A4.000	4	G 8	
1.9 JTD		1910	103	01.2004		192 A5.000	4	G 8	
STRADA (178E)		1.3 D Multijet	1248	62	05.2006		223 A9.000	4	G 7
		1.7 TD	1698	51	06.1999		176 A3.000	4	G 41
		1.9 D	1910	46	12.2000		223 A6.000	4	G 59
	1.9 JTD	1910	59	04.2003		188 A2.000	4	G 60	
	NEW 1.3 D Multijet	1248	70	10.2010		199 B1.000	4	GPE 80	
TALENTO Bus (290)	1.9 D (290UEHK)	1929	52	03.1989	03.1994	149 B1.000	4	G 41	
TALENTO Bus (296_)	NEW 1.6 D	1598	70	06.2016		R9M 413	4	GPE 93	
	NEW 1.6 D	1598	92	06.2016		R9M 452	4	GPE 93	
	NEW 1.6 D	1598	107	06.2016		R9M 452	4	GPE 93	
TALENTO Camionnette (290)	1.9 D (290UK)	1929	52	03.1989	03.1994	149 B1.000	4	G 41	
TALENTO Camionnette (296_)	NEW 1.6 D	1598	70	06.2016		R9M 413	4	GPE 93	
	NEW 1.6 D	1598	85	06.2016		R9M 408	4	GPE 93	
	NEW 1.6 D	1598	88	06.2016		R9M 450-413	4	GPE 93	
	NEW 1.6 D	1598	92	06.2016		R9M 452	4	GPE 93	
	NEW 1.6 D	1598	107	06.2016		R9M 452	4	GPE 93	
	NEW 1.6 D	1598	70	06.2016		R9M 413	4	GPE 93	
TALENTO Camionnette/ Kombi (296_)	NEW 1.6 D	1598	85	06.2016		R9M 408	4	GPE 93	
	NEW 1.6 D	1598	88	06.2016		R9M 450-413	4	GPE 93	
	NEW 1.6 D	1598	92	06.2016		R9M 452	4	GPE 93	
	NEW 1.6 D	1598	107	06.2016		R9M 452	4	GPE 93	
TALENTO Camion/ Plate-forme (290)	1.9 D (290UAK, 290UTK)	1929	52	03.1989	03.1994	149 B1.000	4	G 41	
TALENTO Camion/ Plate-forme (296_)	NEW	1598	92	06.2016		R9M 452	4	GPE 93	
	NEW	1598	107	06.2016		R9M 452	4	GPE 93	
TEMPRA (159)	1.9 D (159.AG)	1929	48	07.1991	08.1996	160 A7.000/149 A1.000	4	G 41	
	1.9 TD (159.AQ)	1929	59	07.1992	08.1996	160 B6.046	4	G 41	
	1.9 TD (159.CU, 159.AU, 159.AI, 159.BI)	1929	66	05.1990	08.1996	160 D1.000/160 A6.000	4	G 41	
TEMPRA S.W. (159)	1.9 D (159.AG)	1929	48	07.1991	08.1996	160 A7.000/149 A1.000	4	G 41	
	1.9 TD (159.AI, 159.BI, 159.CU, 159.AU)	1929	66	07.1991	02.1995	160 D1.000/160 A6.000	4	G 41	

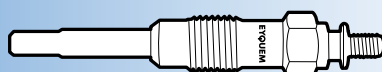



kW



Cyl.



FIAT

	1.9 TD (159.AQ)	1929	59	03.1992	06.1993	160 B6.046	4	G 41
TIPO (160)	1.7 D (160.AG)	1697	43	01.1988	10.1994	149 B4.000	4	G 41
	1.7 D (160.AG)	1697	45	01.1988	10.1995		4	G 41
	1.9 D	1929	48	07.1991	08.1996	160 A7.000/149 A1.000	4	G 41
	1.9 TD (160.AW)	1929	59	03.1992	06.1993	160 B6.046	4	G 41
	1.9 TD (160.EL, 160.GL, 160.AQ, 160.EI, 160.AR)	1929	66	09.1990	04.1995	160 A6.046/160 D1.000/160 A6.000	4	G 41
	1.9 TD (160.EL, 160.GL, 160.AQ, 160.EI, 160.AR)	1929	66	09.1990	04.1995	160 A6.046/160 D1.000/160 A6.000	4	G 41
ULYSSE (179AX)	2.0 D Multijet	1997	88	05.2006		RHK	4	G 30
	2.0 D Multijet	1997	100	05.2006		RHR	4	G 30
	NEW 2.2 D Multijet	2179	125	03.2008	06.2011	4HS/4HT (DW12BTED4)	4	G 88
	2.0 JTD	1997	79	05.2003		RHM(DW10ATED4)	4	G 57
	2.2 JTD	2179	94	08.2002		4HW(DW12ATED4)	4	G 57
	NEW 2.2 JTD	2179	120	03.2008	06.2011	4HP/4HR	4	G 88
ULYSSE (220)	1.9 TD (220AH5)	1905	66	02.1995	08.2002	DHX (XUD9TF/L)	4	G 41
	2.0 JTD	1997	80	10.1999	08.2002	RHZ	4	G 57
	2.1 TD	2088	80	03.1996	10.1999	P8C	4	G 41
UNO (146A/E)	1.3 Super Diesel	1302	33	06.1983	03.1992	146 B1.000/127 A5.000	4	G 41
	1.9 D	1929	44	09.1989	03.1994	149 B5.046	4	G 41
	60 Diesel 1.7	1698	42	09.1989	12.1993	146 B2.000	4	G 41
	60 Diesel 1.7	1698	42	09.1989	12.1993	146 B2.000	4	G 41
	60 Diesel 1.7	1698	44	07.1986	08.1989	149 B3.000	4	G 41
	70 TD 1.4	1367	52	10.1986	10.1990	146 B.000/146 B3.000	4	G 41

FORD

B-MAX	NEW 1.5 TDCi	1499	55	10.2012		UGJC	4	GPE 81
	NEW 1.5 TDCi	1499	70	05.2015		XVJA	4	GPE 81
	NEW 1.6 TDCi	1560	70	10.2012		T3JB	4	GPE 81
C-MAX	1.6 TDCi	1560	66	02.2007		HHDA/HHDB/GPDA	4	G 72
	NEW 1.6 TDCi	1560	74	02.2007		G8DC/MTDA	4	GPE 81
	1.6 TDCi	1560	80	02.2007		G8DA/G8DB/G8DD	4	G 72
	1.8 TDCi	1753	85	02.2007		KKDA	4	G 66
	2.0 TDCi	1997	100	02.2007		G6DD/G6DB/G6DG/G6DA	4	G 30
C-MAX II	NEW 1.5 TDCi	1499	70	04.2015		XXDA	4	GPE 81
	NEW 1.5 TDCi ECOnetic	1499	77	04.2015		AEDA	4	GPE 81
	NEW 1.5 TDCi	1499	88	04.2015		XWDB/XWDE	4	GPE 81
	NEW 1.6 TDCi	1560	70	12.2010		T3DA/T3DB	4	GPE 81
	NEW 1.6 TDCi	1560	85	12.2010		T1DA/T1DB	4	GPE 81
	NEW 2.0 TDCi	1997	85	02.2011		TYDA	4	GPE 81
	NEW 2.0 TDCi	1997	103	02.2011		UFDB	4	GPE 81
	NEW 2.0 TDCi	1997	110	04.2015		T7DB	4	GPE 81
	NEW 2.0 TDCi	1997	120	12.2010		TXDB	4	GPE 81
	NEW 2.0 TDCi	1997	125	04.2015		T8DE	4	GPE 81
ECONOVAN (KBA, KCA)	2.0 D	1998	41	03.1986	03.1992	RF	4	G 12
ECONOVAN Camionnette (KAA)	2.0 D	1998	41	03.1986	03.1992	RF	4	G 12
ESCORT '81 Express (AVA)	1.6 D	1608	40	02.1984	02.1986	LTA	4	G 35
ESCORT '86 Express (AVF)	1.6 D	1608	40	02.1986	07.1990	LTA	4	G 35
	1.8 D	1753	44	07.1988	07.1990	RTA/RTB	4	G 35
ESCORT '91 Express (AVL)	1.8 D	1753	44	07.1990	12.1994	RTH	4	G 35
ESCORT '95 Express (AVL)	1.8 D	1753	44	01.1995		RTH/RTF	4	G 35
	1.8 Turbo D	1753	51	12.1995	06.2001	RVA	4	G 42
ESCORT CLASSIC (AAL, ABL)	1.8 TD	1753	66	10.1998	07.2000	RFD/RFK	4	G 35
ESCORT CLASSIC Turnier (ANL)	1.8 TD	1753	66	02.1999	07.2000	RFD/RFK	4	G 35
ESCORT III (GAA)	1.6 D	1608	40	02.1984	12.1985	LTA	4	G 35
ESCORT III Kombi (AWA)	1.6 D	1608	40	02.1984	12.1985	LTA	4	G 35
ESCORT IV (GAF, AWF, ABFT)	1.6 D	1608	40	01.1986	01.1989	LTC	4	G 35
	1.8 D	1753	44	01.1989	07.1990	RTA/RTB	4	G 35
ESCORT IV Kombi (AWF, AVF)	1.6 D	1608	40	01.1986	01.1989	LTC	4	G 35
	1.8 D	1753	44	01.1989	07.1990	RTA/RTB	4	G 35
ESCORT V (GAL)	1.8 D	1753	44	07.1990	12.1992	RTH/RTF/RTE	4	G 35
ESCORT V Kombi (GAL, AVL)	1.8 D	1753	44	07.1990	12.1992	RTH/RTF/RTE	4	G 35
ESCORT VI (GAL)	1.8 D	1753	44	09.1992	01.1995	RTH/RTF/RTE	4	G 35
	1.8 TD	1753	66	02.1993	01.1995	RFS/RFD/RFK	4	G 35
ESCORT VI Kombi (GAL)	1.8 D	1753	44	09.1992	01.1995	RTH	4	G 35

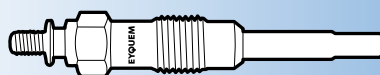



kW



Cyl.



FORD

	1.8 TD	1753	66	02.1993	01.1995	RFD/RFK	4	G 35
ESCORT VI Tricors (GAL)	1.8 D	1753	44	08.1993	01.1995	RTH/RTF/RTE	4	G 35
	1.8 TD	1753	66	08.1993	01.1995	RFD/RFK	4	G 35
ESCORT VII (GAL, AAL, ABL)	1.8 D	1753	44	01.1995	12.1996	RTH/RTF/RTE	4	G 35
	1.8 TD	1753	66	01.1995	10.1998	RFD/RFK	4	G 35
	1.8 Turbo D	1753	51	12.1995	10.1998	RVA	4	G 42
ESCORT VII Cabriolet (ALL)	1.8 TD	1753	66	09.1995	08.1998	RFD/RFK	4	G 35
	1.8 Turbo D	1753	51	10.1996	08.1999	RVA	4	G 42
ESCORT VII Kombi (GAL, ANL)	1.8 D	1753	44	01.1995	02.1999	RTH/RTF/RTE	4	G 35
	1.8 TD	1753	66	01.1995	02.1999	RFD/RFK	4	G 35
	1.8 Turbo D	1753	51	12.1995	02.1999	RVA	4	G 42
ESCORT VII Tricorps (GAL, AFL)	1.8 D	1753	44	01.1995	12.1996	RTH/RTF/RTE	4	G 35
	1.8 TD	1753	66	01.1995	10.1998	RFD/RFK	4	G 35
	1.8 Turbo D	1753	51	12.1995	02.1999	RVA	4	G 42
FIESTA II (FBD)	1.6 D (FBD)	1608	40	04.1984	02.1989	LTB	4	G 35
FIESTA III (GFJ)	1.8 D	1753	44	03.1989	12.1995	RTD/RTG/RTC	4	G 35
	1.8 TD	1753	57	03.1993	12.1995	RFL	4	G 35
FIESTA IV (JA_, JB_)	1.8 D	1753	44	08.1995	04.2000	RTK/RTJ	4	G 42
	1.8 DI	1753	55	04.2000	01.2002	RTP/RTN/RTQ	4	G 66
FIESTA Camionnette (F3L, F5L)	1.8 D	1753	44	09.1991	02.1996	RTD/RTG/RTC	4	G 35
	1.8 D	1753	44	09.1991	02.1996	RTD/RTG/RTC	4	G 35
FIESTA Camionnette (FVD)	1.8 D (FVJ)	1753	43	03.1989	12.1995	RTD/RTG/RTC	4	G 35
FIESTA Camionnette (J5_, J3_)	1.8 D	1753	44	02.1996		RTK	4	G 42
	1.8 DI	1753	55	09.2000		RTP/RTN	4	G 66
FIESTA Camionnette (JV_)	D 1.8	1753	44	05.1998		RTK/RTJ	4	G 42
	TD 1.8	1753	55	03.2000		RTP/RTN/RTQ	4	G 66
FIESTA V (JH_, JD_)	1.4 TDCi	1399	50	11.2001		F6JA/F6JB	4	G 72
	1.6 TDCi	1560	66	11.2004		HHJA/HHJB	4	G 72
FIESTA Van	1.4 TDCi	1399	50	10.2003		F6JA/F6JB	4	G 72
	1.4 TDCi	1399	50	10.2003		F6JA/F6JB	4	G 6
	1.4 TDCi	1399	51	07.2010		F6JD/KVJA	4	G 72
	NEW 1.5 TDCi	1499	55	10.2012		UGJC	4	GPE 81
	NEW 1.5 TDCi	1499	70	05.2015		XVJB	4	GPE 81
	NEW 1.6 TDCi	1560	70	02.2010		TZJA/TZJB	4	GPE 81
	1.6 TDCi	1560	66	01.2009		HHJC/HHJD/HHJE	4	G 72
FIESTA VI	1.4 TDCi	1399	50	01.2009		F6JB	4	G 72
	1.4 TDCi	1399	51	07.2010		F6JD/KVJA	4	G 72
	NEW 1.5 TDCi	1499	55	09.2012		UGJC	4	GPE 81
	NEW 1.5 TDCi	1499	70	05.2015		XVJB	4	GPE 81
	NEW 1.6 TDCi	1560	70	02.2010		T3JA/TZJA/TZJB	4	GPE 81
	1.6 TDCi	1399	66	10.2008		HHJC,HHJD,HHJE	4	G 72
FIESTA VII	NEW 1.5 TDCi	1499	63	01.2017		XUJC	4	GPE 81
	NEW 1.5 TDCi	1499	88	01.2017		XWJA/XWJB	4	GPE 81
FOCUS (DAW, DBW)	1.8 DI / TDDi	1753	55	08.1999	11.2004	BHDB/BHDA	4	G 66
	1.8 TDCi	1753	74	08.2002	11.2004	FFDA	4	G 66
	1.8 TDCi	1753	85	03.2001	11.2004	F9DA/F9DB	4	G 66
	1.8 Turbo DI / TDDi	1753	66	10.1998	11.2004	C9DA/C9DB/C9DC	4	G 66
FOCUS C-MAX	1.6 TDCi	1560	66	02.2005	03.2007	HHDA/HHDB	4	G 72
	1.6 TDCi	1560	80	10.2003	03.2007	G8DA/G8DB	4	G 72
	1.6 TDCi	1560	66	02.2005	03.2007	HHDA/HHDB	4	G 6
	1.6 TDCi	1560	80	10.2003	03.2007	G8DA/G8DB	4	G 6
	1.8 TDCi	1753	85	01.2005	03.2007	KKDA	4	G 66
	2.0 TDCi	1997	100	10.2003	03.2007	G6DD/G6DB/G6DA	4	G 30
FOCUS II (DA_)	1.6 TDCi	1560	66	01.2005		GPDC/HHDA/HHDB/GPDA	4	G 72
	1.6 TDCi	1560	80	11.2004		G8DA/G8DB	4	G 72
	1.6 TDCi	1560	66	01.2005		GPDC/HHDA/HHDB/GPDA	4	G 6
	1.6 TDCi	1560	80	11.2004		G8DA/G8DB	4	G 6
	1.8 TDCi	1753	85	01.2005		KKDA/KKDB	4	G 66
	2.0 TDCi	1997	100	11.2004		G6DD/G6DB/G6DA	4	G 30
FOCUS II Cabriolet	2.0 TDCi	1997	100	10.2006		G6DD/G6DB/G6DA	4	G 30
FOCUS II Kombi (DAW_)	1.6 TDCi	1560	66	11.2004		GPDC/HHDA/HHDB/GPDA	4	G 72
	1.6 TDCi	1560	80	11.2004		G8DA/G8DB	4	G 72
	1.6 TDCi	1560	66	11.2004		GPDC/HHDA/HHDB/GPDA	4	G 6
	1.6 TDCi	1560	80	11.2004		G8DA/G8DB	4	G 6
	1.8 TDCi	1753	85	11.2004		KKDA/KKDB	4	G 66





kW



Cyl.



FORD

		2.0 TDCi	1997	100	11.2004		G6DD/G6DB/G6DA	4	G 30
FOCUS II Tricorps (DA_)		1.6 TDCi	1560	66	04.2005		HHDA/HHDB	4	G 72
		1.6 TDCi	1560	80	04.2005		G8DA/G8DB	4	G 72
		1.6 TDCi	1560	66	04.2005		HHDA/HHDB	4	G 6
		1.6 TDCi	1560	80	04.2005		G8DA/G8DB	4	G 6
		1.8 TDCi	1753	85	04.2005		KKDA/KKDB	4	G 66
FOCUS Kombi (DNW)		2.0 TDCi	1997	100	04.2005		G6DD/G6DB/G6DA	4	G 30
		1.8 DI / TDDi	1753	55	08.1999	11.2004	BHDB/BHDA	4	G 66
		1.8 TDCi	1753	74	08.2002	11.2004	FFDA	4	G 66
		1.8 TDCi	1753	85	03.2001	11.2004	F9DA/F9DB	4	G 66
FOCUS Tricorps (DFW)		1.8 Turbo DI / TDDi	1753	66	02.1999	11.2004	C9DA/C9DB/C9DC	4	G 66
		1.8 TDCi	1753	74	08.2002	11.2004	FFDA	4	G 66
		1.8 TDCi	1753	85	03.2001	11.2004	F9DA/F9DB	4	G 66
		1.8 Turbo DI / TDDi	1753	66	02.1999	11.2004	C9DA/C9DB/C9DC	4	G 66
FOCUS III	NEW	1.5 TDCi	1499	70	09.2014		XXDC	4	GPE 81
	NEW	1.5 TDCi ECOnetic	1499	77	10.2014		AEDA	4	GPE 81
	NEW	1.5 TDCi	1499	88	09.2014		XWDB/XWDC/XWDD/XWDE	4	GPE 81
	NEW	1.6 TDCi	1560	70	04.2011		T3DA/T3DB	4	GPE 81
	NEW	1.6 TDCi ECOnetic	1560	77	05.2012		NGDA	4	GPE 81
	NEW	1.6 TDCi	1560	85	04.2011		T1DA/T1DB	4	GPE 81
	NEW	2.0 TDCi	1997	85	04.2011		TYDA	4	GPE 81
	NEW	2.0 TDCi	1997	103	04.2011		UFDB	4	GPE 81
	NEW	2.0 TDCi	1997	110	11.2014		T7DB	4	GPE 81
	NEW	2.0 TDCi	1997	120	04.2011		TXDB	4	GPE 81
FOCUS III A	NEW	2.0 TDCi ST	1997	136	11.2014		T8DA	4	GPE 81
	NEW	1.5 TDCi	1499	70	11.2014		XXDC	4	GPE 81
	NEW	1.5 TDCi ECOnetic	1499	77	11.2014		AEDA	4	GPE 81
	NEW	1.5 TDCi	1499	88	11.2014		XWDB/XWDE	4	GPE 81
	NEW	1.6 TDCi	1560	70	04.2011		T3DA/T3DB	4	GPE 81
	NEW	1.6 TDCi	1560	85	04.2011		T1DA/T1DB	4	GPE 81
	NEW	2.0 TDCi	1997	85	04.2011		TYDA	4	GPE 81
	NEW	2.0 TDCi	1997	103	04.2011		UFDB	4	GPE 81
	NEW	2.0 TDCi	1997	110	11.2014		T7DB	4	GPE 81
	NEW	2.0 TDCi	1997	120	04.2011		TXDB	4	GPE 81
FOCUS III Turnier	NEW	1.5 TDCi	1499	70	09.2014		XXDC	4	GPE 81
	NEW	1.5 TDCi ECOnetic	1499	77	09.2014		AEDA	4	GPE 81
	NEW	1.5 TDCi	1499	88	09.2014		XWDB/XWDC/XWDD/XWDE	4	GPE 81
	NEW	1.6 TDCi	1560	70	05.2011		T3DA/T3DB	4	GPE 81
	NEW	1.6 TDCi ECOnetic	1560	77	05.2012		NGDA	4	GPE 81
	NEW	1.6 TDCi	1560	85	05.2011		T1DA/T1DB	4	GPE 81
	NEW	2.0 TDCi	1997	85	05.2011		TYDA	4	GPE 81
	NEW	2.0 TDCi	1997	103	05.2011		UFDB	4	GPE 81
	NEW	2.0 TDCi	1997	110	11.2014		T7DB	4	GPE 81
	NEW	2.0 TDCi	1997	120	05.2011		TXDB	4	GPE 81
FUSION (JU_)	NEW	2.0 TDCi ST	1997	136	11.2014		T8DA	4	GPE 81
		1.4 TDCi	1399	50	08.2002		F6JA/F6JB	4	G 72
		1.4 TDCi	1399	50	08.2002		F6JA/F6JB	4	G 6
		1.6 TDCi	1560	66	11.2004		HHJA/HHJB	4	G 6
GALAXY	NEW	2.0 TDCi	1997	88	01.2015		UFCA/UCFB	4	GPE 81
	NEW	2.0 TDCi	1997	110	01.2015		T7CI/T7CJ/T7CL	4	GPE 81
	NEW	2.0 TDCi 4x4	1997	110	05.2015		T7CJ/T7CL	4	GPE 81
	NEW	2.0 TDCi	1997	132	01.2015		T8CH/T8CJ/T8CG	4	GPE 81
	NEW	2.0 TDCi 4x4	1997	132	05.2015		T8CH/T8CJ	4	GPE 81
	NEW	2.0 TDCi Bi-Turbo	1997	154	01.2015		T9CB	4	GPE 81
GALAXY (WAG)	NEW	1.6 TDCi	1560	85	02.2011		T1WA/T1WB	4	GPE 81
		1.8 TDCi	1753	92	05.2006		QYWA	4	G 65
		1.8 TDCi	1753	74	05.2006		FFWA	4	G 66
	NEW	2.0 TDCi	1997	85	03.2010		LLWA/TYWA	4	GPE 81
		2.0 TDCi	1997	96	05.2006		AZWA	4	G 65
	NEW	2.0 TDCi	1997	100	05.2006		AZWC/UKWA	4	GPE 81
		2.0 TDCi	1997	103	05.2006		UFWA/QXWA/QXWC/QXWB	4	G 65
	NEW	2.0 TDCi	1997	103	05.2006		UFWA/QXWA/QXWC/QXWB	4	GPE 81
GALAXY (WGR)	NEW	2.0 TDCi	1997	120	03.2010		TXWA	4	GPE 81
	NEW	2.2 TDCi	2179	129	03.2008	12.2012	Q4BA/Q4WA	4	G 88
		1.9 TDI	1896	66	03.1995	05.2006	ANU/AHU/1Z	4	G 4





kW



Cyl.



FORD

	1.9 TDI	1896	85	04.2000	05.2006	AUY	4	G 4
	1.9 TDI	1896	66	03.1995	05.2006	ANU/AHU/1Z	4	G 17
	1.9 TDI	1896	81	08.1997	04.2000	AVG/AFN	4	G 17
	1.9 TDI	1896	85	04.2000	05.2006	AUY	4	G 17
	1.9 TDI	1896	66	03.1995	05.2006	ANU/AHU/1Z	4	G 37
	1.9 TDI	1896	85	04.2000	05.2006	AUY	4	G 37
	1.9 TDI	1896	66	03.1995	05.2006	ANU/AHU/1Z	4	G 4
	1.9 TDI	1896	96	02.2003	05.2006	ASZ	4	G 4
	1.9 TDI	1896	110	05.2005	05.2006	BTB	4	G 4
	1.9 TDI	1896	81	08.1997	04.2000	AVG/AFN	4	G 37
GRANADA (GU)	1.9 D	1948	40	08.1977	08.1982		4	G 41
	2.1 D	2112	46	08.1977	08.1982	WTA	4	G 41
	2.5 D	2499	51	08.1982	08.1985	STP	4	G 41
GRANADA Kombi (GNU)	2.5 D	2499	51	08.1982	08.1985	STP	4	G 41
GRAND C-MAX	NEW 1.5 TDCi	1499	70	04.2015		XXDC	4	GPE 81
	NEW 1.5 TDCi	1499	88	04.2015		XWDB	4	GPE 81
	NEW 1.6 TDCi	1560	70	12.2010		T3DA/T3DB	4	GPE 81
	NEW 1.6 TDCi	1560	85	12.2010		T1DA/T1DB	4	GPE 81
	NEW 2.0 TDCi	1997	85	02.2011		TYDA	4	GPE 81
	NEW 2.0 TDCi	1997	100	02.2011		UKDB	4	GPE 81
	NEW 2.0 TDCi	1997	110	04.2015		T7DB	4	GPE 81
	NEW 2.0 TDCi	1997	103	02.2011		UFDB	4	GPE 81
	NEW 2.0 TDCi	1997	120	12.2010		TXDB	4	GPE 81
	NEW 2.0 TDCi	1997	125	04.2015		T8DE	4	GPE 81
KA	1.3 TDCi	1248	55	10.2008		FD4	4	G 7
	NEW 1.3 TDCi	1248	55	11.2010		FD4	4	GPE 80
KUGA	2.0 TDCi	1997	100	03.2008		G6DG/UKDA	4	G 30
	2.0 TDCi 4x4	1997	100	03.2008		G6DG/UKDA	4	G 30
KUGA I	NEW 2.0 TDCi	1997	100	03.2008		G6DG/UKDA	4	GPE 81
	NEW 2.0 TDCi	1997	103	03.2010		UFDA	4	GPE 81
	NEW 2.0 TDCi 4x4	1997	100	03.2008		G6DG/UKDA	4	GPE 81
	NEW 2.0 TDCi 4x4	1997	103	03.2010		UFDA	4	GPE 81
	NEW 2.0 TDCi 4x4	1997	120	03.2010		TXDA	4	GPE 81
KUGA II	NEW 1.5 TDCi	1499	88	07.2016		XWMB	4	GPE 81
	NEW 2.0 TDCi	1998	88	09.2014		XRMA/XRMB	4	GPE 81
	NEW 2.0 TDCi, 4x4	1997	100	03.2013		UKMA	4	GPE 81
	NEW 2.0 TDCi	1997	103	03.2013		UFMA	4	GPE 81
	NEW 2.0 TDCi, 4x4	1997	110	09.2014		T7MA/T7MB	4	GPE 81
	NEW 2.0 TDCi 4x4	1997	120	03.2010		TXDA	4	GPE 81
	NEW 2.0 TDCi, 4x4	1998	132	09.2014		T8MA/T8MB	4	GPE 81
MONDEO I (GBP)	1.8 TD	1753	65	06.1993	08.1996	RFM/RFN	4	G 35
	1.8 TD	1753	66	10.1995	08.1996	RFM/RFN	4	G 35
MONDEO I Kombi (BNP)	1.8 TD	1753	65	06.1993	08.1996	RFM/RFN	4	G 35
	1.8 TD	1753	66	11.1995	08.1996	RFM/RFN	4	G 35
MONDEO I Tricorps (GBP)	1.8 TD	1753	65	06.1993	08.1996	RFM/RFN	4	G 35
	1.8 TD	1753	66	10.1995	08.1996	RFM/RFN	4	G 35
MONDEO II (BAP)	1.8 TD	1753	66	09.1996	11.2000	RFN	4	G 42
MONDEO II Kombi (BNP)	1.8 TD	1753	66	09.1996	11.2000	RFN	4	G 42
MONDEO II Tricorps (BFP)	1.8 TD	1753	66	09.1996	11.2000	RFN	4	G 42
MONDEO III (B5Y)	2.0 16V DI / TDDi / TDCi	1998	66	11.2000	08.2007	SDBA/D5BA	4	G 65
	2.0 16V TDDi / TDCi	1998	85	11.2000	08.2007	HJBA/HJBB/D6BA/HJBC	4	G 65
	2.0 TDCi	1998	96	10.2001	08.2007	N7BA/FMBA	4	G 65
	2.2 TDCi	2198	114	09.2004	08.2007	QJBA/QJBB	4	G 65
MONDEO III Kombi (BWy)	2.0 16V DI / TDDi / TDCi	1998	66	11.2000	08.2007	SDBA/D5BA	4	G 65
	2.0 16V TDDi / TDCi	1998	85	11.2000	08.2007	HJBA/HJBB/D6BA/HJBC	4	G 65
	2.0 TDCi	1998	96	10.2001	08.2007	N7BA/FMBA	4	G 65
	2.2 TDCi	2198	114	09.2004	08.2007	QJBA/QJBB	4	G 65
MONDEO III Tricorps (B4Y)	2.0 16V DI / TDDi / TDCi	1998	66	11.2000	08.2007	SDBA/D5BA	4	G 65
	2.0 16V TDDi / TDCi	1998	85	11.2000	08.2007	HJBA/HJBB/D6BA/HJBC	4	G 65
	2.0 TDCi	1998	96	10.2001	08.2007	N7BA/FMBA	4	G 65
	2.2 TDCi	2198	114	09.2004	08.2007	QJBA/QJBB	4	G 65
MONDEO IV (BA7)	NEW 1.6 TDCi	1560	85	02.2011		T1BA/T1BB/T1BC	4	GPE 81
	NEW 2.0 TDCi	1997	85	11.2007		KLBA/LBPA/TYBA	4	GPE 81
	NEW 2.0 TDCi	1997	100	03.2007		AZBC/UKBA	4	GPE 81
	NEW 2.0 TDCi	1997	103	03.2007		QXBA/QXBB/UFBA	4	GPE 81





kW



Cyl.



FORD

	NEW	2.0 TDCi	1997	120	03.2010		TXBA	4	GPE 81
	NEW	2.2 TDCi	2179	129	03.2008	10.2010	Q4BA	4	G 88
		1.8 TDCi	1753	74	03.2007		FFBA	4	G 66
		2.0 TDCi	1997	96	03.2007		AZBA	4	G 30
		2.0 TDCi	1997	103	03.2007		UFBA/QXBB	4	G 30
MONDEO IV A (BA7)	NEW	2.0 TDCi	1997	85	11.2007		KLBA/LBPA/TYBA	4	GPE 81
		2.0 TDCi	1997	96	03.2007		AZBA	4	G 30
	NEW	2.0 TDCi	1997	103	03.2007		QXBA/QXBB/UFBA	4	GPE 81
	NEW	2.0 TDCi	1997	120	03.2010		TXBA	4	GPE 81
	NEW	2.2 TDCi	2179	129	03.2008	10.2010	Q4BA	4	G 88
MONDEO IV Turnier (BA7)	NEW	1.6 TDCi	1560	85	02.2011		T1BA/T1BB/T1BC	4	GPE 81
		1.8 TDCi	1753	74	03.2007		FFBA	4	G 66
	NEW	2.0 TDCi	1997	85	11.2007		KLBA/LBPA/TYBA	4	GPE 81
		2.0 TDCi	1997	96	03.2007		AZBA	4	G 30
	NEW	2.0 TDCi	1997	100	03.2007		AZBC/UKBA	4	GPE 81
		2.0 TDCi	1997	103	03.2007		UFBA/QXBB	4	G 30
	NEW	2.0 TDCi	1997	103	03.2007		QXBA/QXBB/UFBA	4	GPE 81
	NEW	2.0 TDCi	1997	120	03.2010		TXBA	4	GPE 81
	NEW	2.2 TDCi	2179	129	03.2008	10.2010	Q4BA	4	G 88
MONDEO V A	NEW	2.0 TDCi	1998	132	05.2015		T8CA/T8CC/T8CD	4	GPE 81
	NEW	2.0 TDCi 4x4	1998	132	05.2015		T8CC	4	GPE 81
	NEW	2.0 TDCi Bi-Turbo	1998	154	05.2015		T9CA	4	GPE 81
MONDEO V Hatchback	NEW	1.5 TDCi	1499	88	06.2015		UGCC/XUCA	4	GPE 81
	NEW	1.6 TDCi	1560	85	09.2014		U3CA/NGCA	4	GPE 81
	NEW	2.0 TDCi	1998	110	09.2014		T7CE	4	GPE 81
	NEW	2.0 TDCi 4x4	1998	110	02.2015		T7CE	4	GPE 81
	NEW	2.0 TDCi	1998	132	09.2014		T8CA/T8CC/T8CD	4	GPE 81
	NEW	2.0 TDCi 4x4	1998	132	02.2015		T8CC	4	GPE 81
	NEW	2.0 TDCi Bi-Turbo	1998	154	03.2015		T9CA	4	GPE 81
MONDEO V Turnier	NEW	1.5 TDCi	1499	88	05.2015		UGCC/XUCA	4	GPE 81
	NEW	1.6 TDCi	1560	85	09.2014		NGCA	4	GPE 81
	NEW	2.0 TDCi	1998	110	09.2014		T7CE	4	GPE 81
	NEW	2.0 TDCi 4x4	1998	110	02.2015		T7CE	4	GPE 81
	NEW	2.0 TDCi	1998	132	09.2014		T8CC	4	GPE 81
	NEW	2.0 TDCi 4x4	1998	132	02.2015		T8CC	4	GPE 81
	NEW	2.0 TDCi Bi-Turbo	1998	154	03.2015		T9CA	4	GPE 81
ORION I (AFD)		1.6 D	1608	40	02.1984	03.1986	LTA	4	G 35
ORION II (AFF)		1.6 D	1608	40	12.1985	01.1989	LTC	4	G 35
		1.8 D	1753	44	01.1989	07.1990	RTA/RTB	4	G 35
ORION III (GAL)		1.8 D	1753	44	11.1990	12.1993	RTH/RTF/RTE	4	G 35
		1.8 TD	1753	66	03.1992	12.1993	RFD/RFK	4	G 35
P 100 II		1.8 TD	1753	55	10.1987	12.1992	RFA	4	G 35
RANGER (TU_)		2.5 D	2500	57	10.1999	04.2002	WL	4	G 1
		2.5 D 4x4	2500	57	10.1999	04.2002	WL	4	G 1
		2.5 TD 4x4	2500	80	10.1999		WL-T	4	G 1
RANGER (TKE)	NEW	2.2 TDCi	2198	88	04.2011		GBVAJPF	4	GPE 92
	NEW	2.2 TDCi, 4x4	2198	92	04.2011		GBVAJQW	4	GPE 92
	NEW	2.2 TDCi, 4x4	2198	96	05.2015		T22DDOP	4	GPE 92
	NEW	2.2 TDCi	2198	110	11.2011		GBVAJQJ	4	GPE 92
	NEW	2.2 TDCi 4x4	2198	110	04.2011		GBVAJQJ	4	GPE 92
	NEW	2.2 TDCi, 4x4	2198	118	05.2015		T22DDOP		GPE 92
	NEW	3.2 TDCi 4x4	3198	147	04.2011		SAFA	5	GPE 92
SCORPIO I (GAE, GGE)		2.5 D	2498	51	12.1985	02.1992	STR	4	G 41
		2.5 TD	2498	68	06.1988	07.1993	SFA/SFB	4	G 41
		2.5 TD	2500	85	08.1993	09.1994	SCB	4	G 41
SCORPIO I Kombi (GGE)		2.5 D	2499	51	10.1990	08.1992	STR	4	G 41
		2.5 TD	2498	68	09.1991	07.1993	SFA/SFB	4	G 41
		2.5 TD	2500	85	08.1993	09.1994	SCB	4	G 41
SCORPIO I Tricorps (GGE)		2.5 D	2498	51	12.1989	12.1994	STR	4	G 41
		2.5 TD	2498	68	06.1988	07.1993	SFA/SFB	4	G 41
		2.5 TD	2500	85	08.1993	09.1994	SCB	4	G 41
SCORPIO II (GFR, GGR)		2.5 TD	2500	85	10.1994	08.1998	SCC	4	G 40
		2.5 TD	2500	92	09.1996	08.1998	VM	4	G 40
SCORPIO II Kombi (GFR, GGR)		2.5 TD	2500	85	10.1994	08.1998	SCC	4	G 40
		2.5 TD	2500	92	09.1996	08.1998	VM	4	G 40





kW

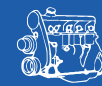

Cyl.



FORD

SIERRA (GBG, GB4)	1.8 TD	1753	55	08.1988	02.1993	RFA/RFB/RFL	4	G 35
	2.3 D	2304	49	01.1987	09.1989	YTR/YTT	4	G 41
SIERRA Kombi (BNC)	1.8 TD	1753	55	08.1988	02.1993	RFA/RFB/RFL	4	G 35
	2.3 D	2304	49	01.1987	02.1993	YTR	4	G 41
	2.3 D	2304	49	08.1982	12.1986	YTT	4	G 41
SIERRA Hatchback (GBC)	2.3 D	2304	49	08.1982	12.1986	YTT	4	G 41
SIERRA Hatchback (GBC, GBG)	1.8 TD	1753	55	08.1988	02.1993	RFA/RFB/RFL	4	G 35
	2.3 D	2304	49	01.1987	09.1989	YTR	4	G 41
S-MAX	NEW 2.0 TDCi	1997	88	01.2015		UFCB	4	GPE 81
	NEW 2.0 TDCi	1997	110	01.2015		T7CJ/T7CJ/T7CL	4	GPE 81
	NEW 2.0 TDCi 4x4	1997	110	01.2015		T7CJ/T7CL	4	GPE 81
	NEW 2.0 TDCi	1997	132	01.2015		T8CH/T8CJ/T8CG	4	GPE 81
	NEW 2.0 TDCi 4x4	1997	132	01.2015		T8CH/T8CJ	4	GPE 81
	NEW 2.0 TDCi Bi-Turbo	1997	154	01.2015		T9CD	4	GPE 81
S-MAX (WA6)	NEW 1.6 TDCi	1560	85	02.2011		T1WA/T1WB	4	GPE 81
	1.8 TDCi	1753	92	05.2006		QYWA	4	G 66
	1.8 TDCi	1753	74	01.2007		FFWA	4	G 66
	NEW 2.0 TDCi	1997	85	11.2007		KLWA/TYWA	4	GPE 81
	2.0 TDCi	1997	96	05.2006		AZWA	4	G 65
	NEW 2.0 TDCi	1997	100	05.2006		AZWC/UKWA	4	GPE 81
	2.0 TDCi	1997	103	05.2006		UFWA/QXWA/QXWC/QXWB	4	G 65
	NEW 2.0 TDCi	1997	103	05.2006		QXWA/QXWB/QXWC/UFWA	4	GPE 81
	NEW 2.0 TDCi	1997	120	03.2010		TXWA	4	GPE 81
	NEW 2.2 TDCi	2179	129	03.2008	12.2012	Q4WA	4	G 88
TOURNEO CONNECT	1.8 DI / TDDi / TDCi	1753	55	06.2002	12.2013	BHPA/P7PA/P7PB/R2PA	4	G 66
	1.8 TDCi	1753	66	06.2002	12.2013	HCPB/HCPA/P9PA/P9PB/R3PA	4	G 66
	1.8 TDCi	1753	81	08.2006	12.2013	RWPA	4	G 66
	1.8 Turbo Di	1753	66	06.2002		HCPB/HCPA	4	G 66
TOURNEO CONNECT Kombi	NEW 1.6 TDCi	1560	55	09.2013		UGBA	4	GPE 81
	NEW 1.6 TDCi	1560	70	09.2013		TZGA/TZGB	4	GPE 81
	NEW 1.6 TDCi	1560	85	09.2013		T1GA	4	GPE 81
TOURNEO CONNECT / GRAND TOURNEO CONNECT Kombi	NEW 1.5 TDCi	1499	55	05.2015		XUGA	4	GPE 81
	NEW 1.5 TDCi	1499	74	05.2015		XVGA	4	GPE 81
	NEW 1.5 TDCi	1499	88	05.2015		XWGA/XWGB	4	GPE 81
TOURNEO COURIER Kombi	NEW 1.5 TDCi	1499	55	02.2014		UGCA/UGCB/XUCC/XUCD	4	GPE 81
	NEW 1.5 TDCi	1499	70	05.2015		XVCA/XVCB/XVCC	4	GPE 81
	NEW 1.6 TDCi	1560	70	02.2014		T3CA/T3CB/T3CC	4	GPE 81
TOURNEO CUSTOM Bus	NEW 2.2 TDCi	2198	74	04.2012		DRFG/DRFF/DRF4	4	GPE 92
	NEW 2.2 TDCi	2198	92	04.2012		CYFA/CYFF	4	GPE 92
	NEW 2.2 TDCi	2198	114	04.2012		CVFF	4	GPE 92
TRANSIT Bus	2.2 TDCi	2198	63	04.2006		P8FA/P8FB	4	G 65
	NEW 2.2 TDCi	2198	74	08.2013		DRF5/DRFG/DRFF	4	GPE 92
	2.2 TDCi	2198	81	04.2006		QVFA	4	G 65
	2.2 TDCi	2198	85	10.2008		SRFC/SRFA/SRFB/SRFE/SRFD	4	G 65
	NEW 2.2 TDCi	2198	92	08.2013		CYF5/CYFG/CY14	4	GPE 92
	2.2 TDCi	2198	96	04.2006		QWFA	4	G 65
	2.2 TDCi	2198	103	10.2007		PGFB/PGFA	4	G 65
	NEW 2.2 TDCi	2198	114	12.2014		CVF5	4	GPE 92
	NEW 2.2 TDCi 4x4	2198	92	08.2013		CYR5/CY24	4	GPE 92
	NEW 2.2 TDCi RWD	2198	74	08.2013		DRR5	4	GPE 92
	NEW 2.2 TDCi RWD	2198	92	08.2013		USR6	4	GPE 92
	NEW 2.2 TDCi RWD	2198	114	08.2013		CVR5/UVR6	4	GPE 92
	NEW 2.2 TDCi AWD	2198	114	12.2014		CVR5	4	GPE 92
	2.4 TDCi	2402	74	04.2006		PHFA/PHFC	4	G 65
	2.4 TDCi	2402	85	04.2006		JXFC/JXFA	4	G 65
	2.4 TDCi	2402	103	04.2006		H9FD	4	G 65
	2.4 TDCi Allrad	2402	103	11.2006		H9FB	4	G 65
	3.2 TDCi	3199	147	02.2008		SAFA/SAFB	5	G 65
TRANSIT Bus (72E, 73E)	2.3 D FT 100 (72E2X)	2332	46	11.1971	09.1978		4	G 35
TRANSIT Bus (FD_, FB_, FS_, FZ_, FC_)	2.0 DI (F_E_, F_F_, F_G_)	1998	55	08.2000	05.2006	D3FA	4	G 65
	2.0 DI (F_E_, F_F_, F_G_)	1998	63	08.2000	05.2006	F3FA	4	G 65
	2.0 DI (F_E_, F_F_, F_G_)	1998	74	08.2000	05.2006	ABFA	4	G 65
	2.0 TDCi (F_F_, F_E_, F_G_)	1998	92	08.2002	05.2006	FIFA	4	G 65





kW



Cyl.



FORD

	2.2 TDCi	2198	63	04.2006		Puma version	4	G 65
	NEW 2.2 TDCi	2198	63	10.2011	08.2014	P8FA/P8FB	4	GPE 92
	NEW 2.2 TDCi	2198	74	10.2011	08.2014	DRFA/DRFB/DRFC/DRFD/DRFE	4	GPE 92
	NEW 2.2 TDCi	2198	81	04.2006		Puma version	4	G 65
	NEW 2.2 TDCi	2198	81	10.2011	08.2014	QVFA	4	GPE 92
	NEW 2.2 TDCi	2198	85	10.2008		Puma version	4	G 65
	NEW 2.2 TDCi	2198	85	10.2011	08.2014	DSL version	4	GPE 92
	NEW 2.2 TDCi	2198	92	10.2011	08.2014	CYFA/CYFB/CYFC/CYFD	4	GPE 92
	NEW 2.2 TDCi	2198	96	04.2006		Puma version	4	G 65
	NEW 2.2 TDCi	2198	96	10.2011	08.2014	QWFA	4	GPE 92
	NEW 2.2 TDCi	2198	103	10.2007		Puma version	4	G 65
	NEW 2.2 TDCi	2198	103	10.2011	08.2014	PGFA/PGFB/UHFA/UHFB/UHFC	4	GPE 92
	NEW 2.2 TDCi RWD	2198	74	10.2011	08.2014	DRRA/DRRB/DRRC	4	GPE 92
	NEW 2.2 TDCi RWD	2198	92	10.2011	08.2014	CYRA	4	GPE 92
	NEW 2.2 TDCi RWD	2198	100	09.2011	08.2014	USRA/USRB	4	GPE 92
	2.4 DI (F_B_, F_C_, F_A_)	2402	66	01.2000	05.2006	D2FA/D2FB/D2FE	4	G 65
	2.4 DI [RWD] (F_B_, F_C_)	2402	55	01.2000	05.2006	F4FA	4	G 65
	2.4 DI [RWD] (F_B_, F_C_, F_A_)	2402	88	01.2000	05.2006	D4FA	4	G 65
	2.4 TDCi	2402	101	03.2004	05.2006	H9FA	4	G 65
	2.4 TDE	2402	85	03.2004	05.2006	FXFA	4	G 65
	2.4 TDE (F_C_, F_B_, F_A_)	2402	92	07.2001	05.2006	DOFA	4	G 65
TRANSIT Bus (V_)	2.4 D (VAS, VBL, VIL, VUL, VZS)	2358	46	12.1977	10.1986	4AA	4	G 35
TRANSIT CONNECT (P65_, P70_, P80_)	1.8 Di	1753	55	06.2002	12.2013	BHPA/P7PA/P7PB/R2PA	4	G 66
	1.8 TDCi	1753	66	06.2002	12.2013	HCPB/HCPA/P9PA/P9PB/R3PA	4	G 66
	1.8 TDCi	1753	81	08.2006	12.2013	RWPA	4	G 66
TRANSIT CONNECT camionnette	NEW 1.5 TDCi	1499	55	08.2015		XUGA	4	GPE 81
	NEW 1.5 TDCi	1499	74	06.2015		XVGA/XVGB/XVGC	4	GPE 81
	NEW 1.5 TDCi	1499	88	06.2015		XWGA	4	GPE 81
	NEW 1.6 TDCi	1560	55	09.2013		UGBA	4	GPE 81
	NEW 1.6 TDCi	1560	70	09.2013		TZGA/TZGB	4	GPE 81
	NEW 1.6 TDCi	1560	85	09.2013		T1GA	4	GPE 81
TRANSIT CONNECT Kombi	NEW 1.5 TDCi	1499	74	06.2015		XVGA	4	GPE 81
	NEW 1.5 TDCi	1499	88	06.2015		XWGA	4	GPE 81
	NEW 1.6 TDCi	1560	55	09.2013		UGBA	4	GPE 81
	NEW 1.6 TDCi	1560	70	09.2013		TZGA/TZGB	4	GPE 81
	NEW 1.6 TDCi	1560	85	09.2013		T1GA	4	GPE 81
TRANSIT COURIER Camionnette	NEW 1.5 TDCi	1499	55	02.2014		UGCA/UGCB/XUCC/XUCD	4	GPE 81
	NEW 1.5 TDCi	1499	70	06.2015		XVCA/XVCB/XVCC	4	GPE 81
	NEW 1.6 TDCi	1560	70	02.2014		T3CA/T3CB/T3CC	4	GPE 81
TRANSIT COURIER Kombi	NEW 1.5 TDCi	1499	55	04.2014		UGCA/UGCB/XUCC/XUCD	4	GPE 81
	NEW 1.5 TDCi	1499	70	06.2015		XVCA/XVCB/XVCC	4	GPE 81
	NEW 1.6 TDCi	1560	70	04.2014		T3CA/T3CB/T3CC	4	GPE 81
TRANSIT Camionnette	2.2 TDCi	2198	63	04.2006		P8FA/P8FB	4	G 65
	NEW 2.2 TDCi	2198	74	08.2013		DRF5/DRFG/DRFF	4	GPE 92
	NEW 2.2 TDCi	2198	92	08.2013		CYF5/CYFG	4	GPE 92
	NEW 2.2 TDCi	2198	114	08.2013		CVF5	4	GPE 92
	NEW 2.2 TDCi 4x4	2198	92	08.2013		CYR5	4	GPE 92
	NEW 2.2 TDCi 4x4	2198	114	08.2013		CVR5	4	GPE 92
	NEW 2.2 TDCi RWD	2198	74	08.2013		DRR5	4	GPE 92
	NEW 2.2 TDCi RWD	2198	92	08.2013		CYR5/USR6	4	GPE 92
	NEW 2.2 TDCi RWD	2198	114	08.2013		CVR5/UJR6	4	GPE 92
	2.2 TDCi	2198	81	04.2006		QVFA	4	G 65
	2.2 TDCi	2198	85	10.2008		SRFC/SRFA/SRFB/SRFE/SRFD	4	G 65
	2.2 TDCi	2198	96	04.2006		QWFA	4	G 65
	2.2 TDCi	2198	103	10.2007		PGFB/PGFA	4	G 65
	2.4 TDCi	2402	74	04.2006		PHFA/PHFC	4	G 65
	2.4 TDCi	2402	85	04.2006		JXFC/JXFA	4	G 65
	2.4 TDCi	2402	103	04.2006		H9FD	4	G 65
	2.4 TDCi Allrad	2402	103	11.2006		H9FB	4	G 65
	3.2 TDCi	3199	147	09.2007		SAFA/SAFB	5	G 65
TRANSIT Camionnette (FA_)	2.0 DI (FAE_, FAF_, FAG_)	1998	55	08.2000	05.2006	D3FA	4	G 65
	2.0 DI (FAE_, FAF_, FAG_)	1998	63	08.2000	05.2006	F3FA	4	G 65
	2.0 DI (FAE_, FAF_, FAG_)	1998	74	08.2000	05.2006		4	G 65
	2.0 TDCi	1998	92	08.2002	05.2006	FIFA	4	G 65





kW



Cyl.



FORD

	2.2 TDCi	2198	63	04.2006		Puma version	4	G 65
	NEW 2.2 TDCi	2198	63	10.2011	08.2014	DSL version	4	GPE 92
	NEW 2.2 TDCi	2198	74	10.2011	08.2014	DRFA/DRFB/DRFC/DRFD/DRFE	4	GPE 92
	NEW 2.2 TDCi	2198	81	04.2006		Puma version	4	G 65
	NEW 2.2 TDCi	2198	81	10.2011	08.2014	QVFA	4	GPE 92
	NEW 2.2 TDCi	2198	85	10.2008		Puma version	4	G 65
	NEW 2.2 TDCi	2198	85	10.2011	08.2014	SRFA/SRFB/SRFC/SRFD/SRFE	4	GPE 92
	NEW 2.2 TDCi	2198	92	10.2011	08.2014	CYFA/CYFB/CYFC/CYFD	4	GPE 92
	NEW 2.2 TDCi	2198	96	04.2006		Puma version	4	G 65
	NEW 2.2 TDCi	2198	96	10.2011	08.2014	DSL version	4	GPE 92
	NEW 2.2 TDCi	2198	103	10.2007		Puma version	4	G 65
	NEW 2.2 TDCi	2198	103	10.2011	08.2014	DSL version	4	GPE 92
	NEW 2.2 TDCi 4x4	2198	92	10.2011	08.2014	CYRB/CYRC	4	GPE 92
	NEW 2.2 TDCi RWD	2198	74	10.2011	08.2014	DRRA/DRRB/DRRC	4	GPE 92
	NEW 2.2 TDCi RWD	2198	92	10.2011	08.2014	CYRA	4	GPE 92
	NEW 2.2 TDCi RWD	2198	110	10.2011		CVRA/CVRB/CVRC	4	GPE 92
	2.4 DI (FAA_, FAB_, FAC_, FAD_)	2402	66	01.2000	05.2006	D2FA/D2FB/D2FE	4	G 65
	2.4 DI [RWD] (FAA_, FAB_, FAC_, FAD_)	2402	55	01.2000	05.2006	F4FA	4	G 65
	2.4 DI [RWD] (FAA_, FAB_, FAC_, FAD_)	2402	88	01.2000	05.2006		4	G 65
	2.4 TDCi	2402	101	03.2004	05.2006	H9FA	4	G 65
	2.4 TDE	2402	85	03.2004	05.2006	FXFA	4	G 65
	2.4 TDE	2402	92	07.2001	05.2006	DOFA	4	G 65
TRANSIT Camionnette (V_)	2.4 D (VVS)	2358	46	11.1977	10.1986	4AA	4	G 35
TRANSIT Camion/Plate-forme	2.2 TDCi	2198	63	04.2006		P8FA/P8FB	4	G 65
	NEW 2.2 TDCi	2198	74	08.2013		DRF5/DRFG/DRFF	4	GPE 92
	NEW 2.2 TDCi	2198	92	08.2013		CYF5	4	GPE 92
	NEW 2.2 TDCi	2198	114	08.2013		CVF5	4	GPE 92
	NEW 2.2 TDCi 4x4	2198	92	08.2013		CYR5	4	GPE 92
	NEW 2.2 TDCi 4x4	2198	114	08.2013		CVR5	4	GPE 92
	NEW 2.2 TDCi RWD	2198	74	08.2013		DRR5	4	GPE 92
	NEW 2.2 TDCi RWD	2198	92	08.2013		USR6	4	GPE 92
	NEW 2.2 TDCi RWD	2198	114	08.2013		CVR5/UVR6	4	GPE 92
	2.2 TDCi	2198	81	04.2006		QVFA	4	G 65
	2.2 TDCi	2198	85	10.2008		SRFC/SRFA/SRFB/SRFE/SRFD	4	G 65
	2.2 TDCi	2198	96	04.2006		QWFA	4	G 65
	2.2 TDCi	2198	103	10.2007		PGFB/PGFA	4	G 65
	2.4 TDCi	2402	74	04.2006		PHFA/PHFC	4	G 65
	2.4 TDCi	2402	85	04.2006		JXFC/JXFA	4	G 65
	2.4 TDCi	2402	103	04.2006		H9FD	4	G 65
	2.4 TDCi Allrad	2402	103	11.2006		H9FB	4	G 65
	3.2 TDCi	3199	147	09.2007		SAFA/SAFB	5	G 65
TRANSIT Camion/ Plate-forme (FM_ , FN_)	2.0 DI (F_E_ , F_F_)	1998	55	08.2000	05.2006	D3FA	4	G 65
	2.0 DI (F_E_ , F_F_)	1998	63	08.2000	05.2006	F3FA	4	G 65
	2.0 DI (F_E_ , F_F_)	1998	74	08.2000	05.2006	ABFA	4	G 65
	2.0 TDCi (F_E_ , F_F_)	1998	92	08.2002	05.2006	FIFA	4	G 65
	NEW 2.2 TDCi	2198	63	04.2006		Puma version	4	G 65
	NEW 2.2 TDCi	2198	63	10.2011	08.2014	P8FA/P8FB	4	GPE 92
	NEW 2.2 TDCi	2198	74	04.2006	08.2014	DRFA/DRFB/DRFC/DRFD/DRFE	4	GPE 92
	NEW 2.2 TDCi	2198	81	04.2006		Puma version	4	G 65
	NEW 2.2 TDCi	2198	81	10.2011	08.2014	QVFA	4	GPE 92
	NEW 2.2 TDCi	2198	85	10.2008		Puma version	4	G 65
	NEW 2.2 TDCi	2198	85	10.2011	08.2014	SRFA/SRFB/SRFC/SRFD/SRFE	4	GPE 92
	NEW 2.2 TDCi	2198	92	10.2011	08.2014	CYFA/CYFB/CYFC/CYFD	4	GPE 92
	2.2 TDCi	2198	96	04.2006		Puma version	4	G 65
	NEW 2.2 TDCi	2198	96	10.2011	08.2014	DSL version	4	GPE 92
	NEW 2.2 TDCi 4x4	2198	92	10.2011	08.2014	CYRB/CYRC	4	GPE 92
	NEW 2.2 TDCi RWD	2198	74	10.2011	08.2014	DRRA/DRRB/DRRC	4	GPE 92
	NEW 2.2 TDCi RWD	2198	92	10.2011	08.2014	CYRA	4	GPE 92
	NEW 2.2 TDCi RWD	2198	114	10.2011	08.2014	CVRA/CVRB/CVRC	4	GPE 92
	2.4 DI (F_A_ , F_B_ , F_C_ , F_D_)	2402	55	01.2000	05.2006	F4FA	4	G 65
	2.4 DI (F_A_ , F_B_ , F_C_ , F_D_)	2402	66	01.2000	05.2006	D2FA/D2FB/D2FE	4	G 65
	2.4 DI (F_A_ , F_B_ , F_C_ , F_D_)	2402	88	01.2000	05.2006	D4FA	4	G 65

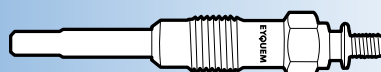



kW



Cyl.



FORD

	2.4 TDCi	2402	101	03.2004	05.2006	H9FA	4	G 65
	2.4 TDE	2402	85	03.2004	05.2006	FXFA	4	G 65
	2.4 TDE	2402	92	07.2001	05.2006	DOFA	4	G 65
TRANSIT Camion/Plate-forme (V_ _)	2.4 D (VGL, VSL, VTL, VCS, VDS)	2358	46	11.1977	09.1985	4AA	4	G 35
TRANSIT CUSTOM Bus	NEW 2.2 TDCi	2198	74	04.2012		DRF4/DRFF/DRFG	4	GPE 92
	NEW 2.2 TDCi	2198	92	04.2012		CYF4/CYFF	4	GPE 92
	NEW 2.2 TDCi	2198	114	04.2012		CVFF	4	GPE 92
TRANSIT CUSTOM Camionnette	NEW 2.2 TDCi	2198	74	04.2012		DRF4/DRFF/DRFG	4	GPE 92
	NEW 2.2 TDCi	2198	92	04.2012		CYF4/CYFF	4	GPE 92
	NEW 2.2 TDCi	2198	114	04.2012		CVFF	4	GPE 92
TRANSIT TOURNEO	NEW 2.2 TDCi	2198	81	07.2006		Puma version	4	G 65
	NEW 2.2 TDCi	2198	81	10.2011		DSL version	4	GPE 92
	2.2 TDCi	2198	85	10.2008		Puma version	4	G 65
	2.2 TDCi	2198	85	10.2011	08.2014	DSL version	4	GPE 92
	2.2 TDCi	2198	96	07.2006		Puma version	4	G 65
	NEW 2.2 TDCi	2198	96	10.2011		DSL version	4	GPE 92
	2.2 TDCi	2198	103	10.2007		PGFB/PGFA	4	G 65
	NEW 2.2 TDCi	2198	103	10.2011		DSL version	4	GPE 92

FSO

POLONEZ II	1.9 D	1905	51	08.1988	08.1992	XUD 9A	4	G 41
POLONEZ III	1.9 D	1905	51	09.1992		XUD 9A	4	G 41

HONDA

ACCORD VI (CE, CF)	2.0 TDi (CF1)	1994	77	04.1996	10.1998	20T2N	4	G 51
ACCORD VII (CG, CK)	2.0 Turbo Di	1994	77	02.1999	12.2002	20T2N	4	G 36
CIVIC VI Aerodeck (MB, MC)	2.0 i D (MC3)	1994	74	04.1998	02.2001	20T2N	4	G 51
	2.0 i D (MC3)	1994	77	04.1998	02.2001	20T2N	4	G 51
CIVIC VI Fastback (MA, MB)	2.0 TDiC (MB7)	1994	74	11.1998	10.2000	20T2N	4	G 51
	2.0 TDiC (MB7)	1994	77	11.1998	10.2000	20T2N	4	G 51
CIVIC VI Hatchback (EJ, EK)	2.0 TDiC	1994	77	11.1998	10.2000	20T2N	4	G 51
CIVIC VII Hatchback (EU, EP, EV)	1.7 CTDi	1686	74	01.2002	09.2005	4EE-2	4	G 68

HYUNDAI

ACCENT II (LC)	1.5 CRDi	1493	60	04.2002	11.2005	D3-EA	3	G 25
ACCENT Tricorps (LC)	1.5 CRDi	1493	60	01.2002	11.2005	D3-EA	3	G 25
ACCENT III (MC)	NEW 1.5 CRDi GLS	1493	81	11.2005	11.2010	D4FA	4	G 85
ACCENT A III (MC)	NEW 1.5 CRDi GLS	1493	81	11.2005	11.2010	D4FA	4	G 85
ELANTRA (XD)	2.0 CRDi	1991	83	04.2001	07.2006	D4EA	4	G 25
	NEW 1.6 CRDi	1582	85	02.2006	07.2006	D4FB	4	G 85
ELANTRA A (XD)	1.5 D	1493	82	06.2000	07.2006	D4FA	4	G 25
	2.0 CRDi	1991	83	04.2001	07.2006	D4EA	4	G 25
ELANTRA A (HD)	NEW 1.6 CRDi	1582	85	11.2005	12.2011	D4FB	4	G 85
ELANTRA A (MD, UD)	NEW 1.6 CRDi	1582	94	02.2011	12.2015	D4FB	4	G 85
GALLOPER I	2.5 TD	2477	62	07.1994	12.1995	4D56T	4	G 32
	2.5 TD	2477	62	01.1996	07.1998	4D56T	4	G 69
	2.5 TD intercooler	2477	70	07.1994	12.1995	4D56T	4	G 32
	2.5 TD intercooler	2477	70	01.1996	07.1998	4D56T	4	G 69
GALLOPER II (JK-01)	2.5 TD	2476	65	08.1998	12.2003	D4BA/D4BF	4	G 69
	2.5 Tci D	2476	77	08.1998	12.2003	D4BH	4	G 69
	2.5 TD intercooler	2476	73	08.1998	12.2003	D4BH	4	G 69
GETZ (TB)	1.5 CRDi	1493	60	03.2003	09.2005	D3-EA	3	G 25
	NEW 1.5 CRDi	1493	65	08.2005	06.2009	D4FA	4	G 85
	NEW 1.5 CRDi GLS	1493	81	08.2005	06.2009	D4FA	4	G 85
GRANDEUR (TG)	2.2 CRDi	2188	110	06.2006	12.2011	D4EB	4	G 25
	2.2 CRDi	2188	114	06.2006	10.2010	D4EB	4	G 25
H-1 Cargo (TQ)	2.5 CRDi	2497	81	02.2008		D4CB	4	G 77
	2.5 CRDi	2497	85	08.2011		D4CB	4	G 77
	2.5 CRDi	2497	100	08.2009		D4CB-W	4	G 77
	2.5 CRDi	2497	120	02.2008		D4CB-L	4	G 77
	2.5 CRDi	2497	125	02.2008		D4CB	4	G 77
H-1 Camionnette	2.5 CRDi	2497	81	07.2001	04.2004	D4CB	4	G 77
	2.5 CRDi	2497	103	08.2003	12.2007	D4CB	4	G 77
	2.5 TD	2476	74	10.2001		D4BH	4	G 32
	2.5 TD	2476	74	10.2001	07.2003	D4BH	4	G 69





kW



Cyl.



HYUNDAI

	2.5 TD	2476	73	03.2000		D4BH	4	G 32
	2.5 TD	2476	73	03.2000		D4BH	4	G 69
	2.5 TD	2476	59	03.2000	09.2000	D4BF	4	G 32
H-1 Camion/Plate-forme	2.5 D	2476	73	06.2000	12.2005	D4BH	4	G 32
	2.5 D	2476	73	06.2000	12.2005	D4BH	4	G 69
H-1 Starex (KMF)	2.5 D	2476	57	10.1997			4	G 31
	2.5 TD	2476	74	11.2001		D4BH	4	G 31
	2.5 TD	2476	74	11.2001		D4BH	4	G 69
	2.5 TD	2476	73	10.1999	11.2001	D4BH	4	G 69
	2.5 TD	2476	59	10.1997		D4BF	4	G 32
H-1 Travel (TQ)	2.5 CRDi	2497	81	07.2010	04.2011	D4CB OE n°36710 4A000	4	G 77
	2.5 CRDi	2497	85	08.2011		D4CB	4	G 77
	2.5 CRDi	2497	100	07.2008		D4CB	4	G 77
	2.5 CRDi	2497	125	05.2008		D4CB	4	G 77
H100 Bus (P)	2.5 D	2477	55	07.1993	12.1994	D4BA/D4BX	4	G 31
	2.5 D	2477	57	12.1994	03.2000	D4BA	4	G 31
	2.5 TD	2477	59	07.1993	03.2000	D4BF	4	G 32
H100 Camionnette	2.5 TDiC	2476	59	06.1998	02.2003	D4BF	4	G 31
	2.5 D	2477	55	07.1993	12.1994	D4BA/D4BX	4	G 31
	2.5 D	2477	57	12.1994	03.2000	D4BA	4	G 31
H100 Camion/Plate-forme	2.5 D	2476	57	07.1993	12.1997	D4BA	4	G 31
	2.5 D	2476	59	05.1996	12.1997	D4BF	4	G 31
H100 Pick-up	2.5 D	2476	57	05.1996	10.2001	D4BA	4	G 31
i10 (PA)	NEW 1.1 CRDi	1120	55	01.2008	12.2011	D3FA	3	G 85
i20 (GB)	NEW 1.1 CRDi	1120	55	11.2014		D3FA	3	G 85
	NEW 1.4 CRDi	1396	66	11.2014		D4FC	4	G 85
i20 (PB, PBT)	NEW 1.1 CRDi	1120	55	03.2012	12.2015	D3FA	3	G 85
	NEW 1.4 CRDi	1396	55	09.2008	12.2012	D4FC	4	G 85
	NEW 1.4 CRDi	1396	66	08.2008	12.2015	D4FC	4	G 85
	NEW 1.6 CRDi	1582	85	09.2008	12.2012	D4FB	4	G 85
	NEW 1.6 CRDi	1582	94	01.2009	12.2012	D4FB	4	G 85
i30 (FD)	NEW 1.6 CRDi	1582	66	10.2007	11.2011	D4FB	4	G 85
	NEW 1.6 CRDi	1582	85	10.2007	11.2011	D4FB	4	G 85
	NEW 1.6 CRDi	1582	94	01.2010	11.2011	D4FB	4	G 85
	2.0 CRDi	1991	100	10.2007	11.2011	D4EA-F	4	G 25
	2.0 CRDi	1991	103	10.2007	11.2011	D4EA-F	4	G 25
i30 SW (FD)	NEW 1.4 CRDi	1396	66	06.2012		D4FC	4	G 85
	NEW 1.6 CRDi	1582	66	02.2008	06.2012	D4FB	4	G 85
	NEW 1.6 CRDi	1582	85	02.2008	06.2012	D4FB	4	G 85
	NEW 1.6 CRDi	1582	94	01.2010	06.2012	D4FB	4	G 85
	2.0 CRDi	1991	100	10.2008	06.2012	D4EA-F	4	G 25
	2.0 CRDi	1991	103	02.2008	06.2012	D4EA-F	4	G 25
i30 (GD)	NEW 1.4 CRDi	1396	66	11.2011	12.2016	D4FC	4	G 85
	NEW 1.6 CRDi	1582	81	12.2011	12.2016	D4FB	4	G 85
	NEW 1.6 CRDi	1582	94	11.2011	12.2015	D4FB	4	G 85
i30 SW (GD)	NEW 1.4 CRDi	1396	66	06.2012		D4FC	4	G 85
	NEW 1.6 CRDi	1582	81	06.2012		D4FB	4	G 85
	NEW 1.6 CRDi	1582	94	06.2012	12.2015	D4FB-5P	4	G 85
i30 Coupé	NEW 1.4 CRDi	1396	66	05.2013		D4FC	4	G 85
	NEW 1.6 CRDi	1582	94	05.2013		D4FB	4	G 85
ix20 (JC)	NEW 1.4 CRDi	1396	57	06.2011		D4FC-M	4	G 85
	NEW 1.4 CRDi	1396	66	11.2010		D4FC	4	G 85
	NEW 1.6 CRDi	1582	85	06.2011		D4FB	4	G 85
	NEW 1.6 CRDi	1582	94	06.2011		D4FB	4	G 85
ix35 (LM, EL, ELH)	NEW 1.7 CRDi	1685	85	11.2010		D4FD	4	G 85
LANTRA II (J-2)	1.9 D	1905	50	03.1998	09.2000	DJY	4	G 41
LANTRA II SW (J-2)	1.9 D	1905	50	03.1998	09.2000	DJY	4	G 41
MATRIX (FC)	1.5 CRDi	1496	60	10.2001	08.2010	D3EA	3	G 25
	NEW 1.5 CRDi	1493	75	12.2004	08.2010	D4FA	4	G 85
	NEW 1.5 CRDi VGT	1493	81	08.2005	08.2010	D4FA	4	G 85
PORTER (Camionnette)	2.5 TD	2476	57	07.1994	04.2004	D4BA	4	G 31
	2.5 TD	2476	73	07.1994	04.2004	D4BH	4	G 32
	2.5 CRDi	2497	103	02.2003	04.2004	D4CB	4	G 77
PORTER (Pick-up)	2.5 TD	2476	57	07.1994	04.2004	D4BA	4	G 31
	2.5 TD	2476	73	07.1994	04.2004	D4BH	4	G 32

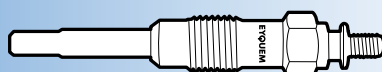



kW



Cyl.



HYUNDAI

	2.5 CRDi	2497	103	02.2003	04.2004	D4CB	4	G 77
SANTA FÉ I (SM)	2.0 CRDi, 4x4	1991	83	08.2001	03.2006	D4EA	4	G 25
	2.0 CRDi, 4x4	1991	92	08.2003	03.2006	D4EA-V	4	G 25
	2.0 CRDi, Traction integrale	1991	107	11.2003	12.2005	D4EA-F	4	G 25
SANTA FÉ II (CM)	2.0 CRDi 4x4	1991	92	08.2003		D4EA	4	G 25
	2.2 CRDi, 4x4	2188	102	03.2006	09.2009	D4EB	4	G 25
	2.2 CRDi GLS, 4x4	2188	110	03.2006	09.2009	D4EB	4	G 25
	2.2 CRDi, 4x4	2188	114	03.2006	09.2009	D4EB	4	G 25
	2.2 CRDi, 4x4	2199	145	01.2009	09.2009	D4HB	4	G 25
SATELLITE	2.5 TD	2476	57	06.1997		D4BF	4	G 31
	2.5 TD	2476	59	06.1997		D4BF	4	G 31
	2.5 TD 4WD	2476	59	02.1998		D4BF	4	G 31
	2.5 TCi	2476	73	10.1997	12.2007	D4BH	4	G 32
	2.5 TCi	2476	73	10.1997	12.2007	D4BH	4	G 69
	2.5 TD 4WD	2476	73	03.2001	04.2004	D4BH	4	G 32
	2.5 TD 4WD	2476	73	03.2001	04.2004	D4BH	4	G 69
	2.5 TCi	2476	74	05.2004	12.2007	D4BH	4	G 32
	2.5 TCi, 4WD	2476	74	05.2004	12.2007	D4BH	4	G 69
	2.5 CRDi	2497	81	06.2006	12.2007	D4CB	4	G 77
	2.5 CRDi	2497	85	06.1997	04.2004	D4CB	4	G 77
	2.5 CRDi, 4WD	2497	103	12.2002	04.2004	D4CB	4	G 77
	2.5 CRDi	2497	120	12.2002	04.2004	D4CB	4	G 77
SONATA V (NF)	2.0 CRDi	1991	100	02.2006	12.2010	D4EA-F	4	G 25
	2.0 CRDi	1991	103	02.2006	12.2010	D4EA-F	4	G 25
	2.0 CRDi	1991	110	03.2009	12.2010	D4EA-F	4	G 25
TERRACAN (HP)	2.5 TD	2476	74	12.2001	12.2004	D4BH	4	G 32
	2.9 CRDi 4WD	2902	110	12.2001	07.2003	J3	4	G 69
	2.9 CRDi 4WD	2902	120	11.2003	12.2006	J3	4	G 69
TRAJET (FO)	2.0 CRDi	1991	83	04.2001	07.2008	D4EA	4	G 25
TUCSON (JM)	2.0 CRDi	1991	83	08.2004	03.2010	D4EA	4	G 25
	2.0 CRDi	1991	100	01.2006	03.2010	D4EA-F	4	G 25
	2.0 CRDi	1991	103	01.2006	03.2010	D4EA-F	4	G 25
	2.0 CRDi	1991	110	01.2009	03.2010	D4EA-F	4	G 25

INNOCENTI

ELBA (146)	1.7 D (146DI, 146EI)	1697	42	08.1991	12.1996	146 B2.000	4	G 41
------------	----------------------	------	----	---------	---------	------------	---	------

ISUZU

CAMPO (KB)	2.2 D (KBD27)	2238	39	04.1986	12.1990	C223	4	G 45
	2.2 D (KBD27)	2238	39	04.1986	12.1990	C223	4	G 47
	2.2 D 4WD (KBD42, KBD47)	2238	39	01.1983	12.1990	C223	4	G 45
	2.2 D 4WD (KBD42, KBD47)	2238	39	01.1983	12.1990	C223	4	G 47
GEMINI (JT)	1.5 D	1488	37	02.1988	12.1990	4EC1	4	G 47
	1.5 TD	1488	49	02.1988	12.1990	4EC1T	4	G 48
	1.5 TD	1488	49	02.1988	12.1990	4EC1T	4	G 46
GEMINI Tricorps (JT)	1.5 D	1488	37	02.1988	12.1990	4EC1	4	G 47
	1.5 D	1488	37	02.1988	12.1990	4EC1	4	G 45
	1.5 D	1488	37	02.1988	12.1990	4EC1	4	G 45
	1.5 D	1488	37	02.1988	12.1990	4EC1	4	G 47
	1.5 TD	1488	49	02.1988	12.1990	4EC1T	4	G 48
	1.5 TD	1488	49	02.1988	12.1990	4EC1T	4	G 46
	1.5 TD	1488	49	02.1988	12.1990	4EC1T	4	G 46
	1.5 TD	1488	49	02.1988	12.1990	4EC1T	4	G 48
MIDI Bus (94000, 98000)	2.0 TD (98000)	1995	51	01.1989		4FC1T	4	G 46
	2.0 TD (98000)	1995	51	01.1989		4FC1T	4	G 48
	2.2 D (98000)	2189	45	01.1989		4FD1	4	G 46
	2.2 D (98000)	2189	45	01.1989		4FD1	4	G 48
	2.2 D 4WD (94000)	2189	45	01.1989		4FD1	4	G 46
	2.2 D 4WD (94000)	2189	45	01.1989		4FD1	4	G 48
	2.4 D (98000)	2380	56	01.1994		4FG1T	4	G 46
	2.4 D (98000)	2380	56	01.1994		4FG1T	4	G 48
MIDI Camionnette (98000N)	2.4 TD 4x4	2389	56	01.1994	07.1996	4FG1T	4	G 46
	2.4 TD 4x4	2389	56	01.1994	07.1996	4FG1T	4	G 48
	2.2 D	2189	45	01.1989		4FD1	4	G 46
	2.2 D	2189	45	01.1989		4FD1	4	G 48

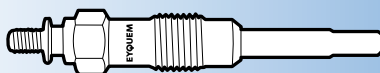



kW



Cyl.

**ISUZU**

	2.2 D 4WD	2189	45	09.1988		4FD1	4	G 46
	2.2 D 4WD	2189	45	09.1988		4FD1	4	G 48
	2.4 TD	2380	56	02.1994		4FG1T	4	G 46
	2.4 TD	2380	56	02.1994		4FG1T	4	G 48
	2.4 TD 4x4	2389	56	01.1994	07.1996	4FG1T	4	G 46
	2.4 TD 4x4	2389	56	01.1994	07.1996	4FG1T	4	G 48
MIDI Van (94000, 98000)	2.0 TD (98000)	1995	51	01.1989		4FC1T	4	G 46
	2.0 TD (98000)	1995	51	01.1989		4FC1T	4	G 48
	2.2 D (98000)	2189	45	01.1989		4FD1	4	G 46
	2.2 D (98000)	2189	45	01.1989		4FD1	4	G 48
	2.2 D 4WD (94000)	2189	45	01.1989		4FD1	4	G 46
	2.2 D 4WD (94000)	2189	45	01.1989		4FD1	4	G 48
	2.4 TD (98000)	2380	56	01.1994		4FG1T	4	G 46
	2.4 TD (98000)	2380	56	01.1994		4FG1T	4	G 48
	2.4 TD 4x4	2389	56	01.1994	07.1996	4FG1T	4	G 46
	2.4 TD 4x4	2389	56	01.1994	07.1996	4FG1T	4	G 48
TROOPER Soft Top (UBS)	2.2 TD (UBS52)	2238	53	03.1984	12.1991	C223T	4	G 47
	2.2 TD (UBS52)	2238	53	03.1984	12.1991	C223T	4	G 45

IVECO

DAILY I Camionnette/Kombi	30-8 (10014131, 10014132, 10014137, 10014231, 10014232, 1001	2445	53	01.1978	12.1989	8140.61.200	4	G 41
	30-8 (12914111, 12914112, 12914117, 12914131, 12914137, 1291	2499	60	01.1989	08.1998	8140.67F.	4	G 35
	30-8 (12914111, 12914112, 12914117, 12914131, 12914137, 1291	2499	60	01.1989	08.1998	8140.67F.	4	G 35
	30-8 (14914111, 14914117, 14914211, 14914217, 14915111, 1491	2798	62	09.1998		8140.63.	4	G 62
	30-8 (14914111, 14914117, 14914211, 14914217, 14915111, 1491	2499	60	01.1996	08.1998	8140.67F.	4	G 35
	30-8 V (14914111, 14914117, 14914211, 14914217, 14915111, 14	2798	62	09.1998		8140.63.	4	G 62
	35-10 (10314204, 10314211, 10314212, 10314217, 10314411, 103	2445	68	01.1985	12.1989	8140.21.200	4	G 41
	35-8 (10034131, 10034132, 10034137, 10034224, 10034231, 1003	2445	53	01.1978	12.1989	8140.61.200	4	G 41
	35-8 (12934104, 12934111, 12934112, 12934117, 12934124, 1293	2499	60	01.1991	08.1998	8140.67F.	4	G 35
	35-8 (12934104, 12934111, 12934112, 12934117, 12934124, 1293	2499	60	01.1991	08.1998	8140.67F.	4	G 35
	35-8 (14934104, 14934111, 14934204, 14934205, 14934211, 1493	2798	62	09.1998		8140.63.	4	G 62
	40-8 V	2445	53	01.1983	06.1989	8140.61.200	4	G 41
	45-10 V (10334204, 10334211, 10334212, 10334217, 10334404)	2445	68	01.1985	12.1989	8140.21.200	4	G 35
	49-10 V (10354204, 10354211, 10354212, 10354217, 10354404, 1	2445	68	01.1985	12.1989	8140.21.200	4	G 41
DAILY I Kipper	35-8 K (14930304, 14931104, 14931111, 14931115, 14931204, 14	2798	62	09.1998		8140.63.	4	G 62

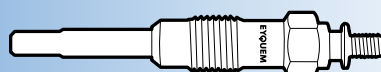



kW



Cyl.



IVECO

DAILY I Camion/Plate-forme	30-8 (10011131, 10011132, 10011231, 10011232, 10011237, 1001	2798	62	09.1998	05.1999	8140.63.	4	G 62
	30-8 (10011131, 10011132, 10011231, 10011232, 10011237, 1001	2499	60	01.1996	08.1998	8140.67F.	4	G 35
	30-8 (10011131, 10011132, 10011231, 10011232, 10011237, 1001	2445	53	01.1978	12.1989	8140.61.200	4	G 41
	30-8 (12910211, 12911111, 12911112, 12911117, 12911131, 1291	2499	60	01.1992	08.1998	8140.67F.	4	G 35
	30-8 (12910211, 12911111, 12911112, 12911117, 12911131, 1291	2499	60	01.1992	08.1998	8140.67F.	4	G 35
	30-8 (14911111, 14911117, 14911211, 14911215, 14911217, 1491	2798	62	09.1998	05.1999	8140.63.	4	G 62
	35-10 (10310311, 10311111, 10311112, 10311117, 10311211, 103	2445	68	01.1985	12.1989	8140.21.200	4	G 41
	35-8 (10031131, 10031132, 10031137, 10031224, 10031231, 1003	2445	53	01.1978	12.1989	8140.61.200	4	G 41
	35-8 (12931102, 12931104, 12931111, 12931112, 12931117, 1293	2499	60	01.1989	08.1998	8140.67F.	4	G 35
	35-8 (12931102, 12931104, 12931111, 12931112, 12931117, 1293	2499	60	01.1989	08.1998	8140.67F.	4	G 35
	35-8 (14930304, 14931104, 14931111, 14931115, 14931204, 1493	2798	62	09.1998	05.1999	8140.63.	4	G 62
	40-8	2445	53	01.1983	06.1989	8140.61.200	4	G 41
	45-10 (10331211, 10331212, 10331217, 10331304, 10331311, 103	2445	68	01.1985	12.1989	8140.21.200	4	G 35
	49-10 (10350211, 10350304, 10350311, 10350404, 10350411, 103	2445	68	01.1985	12.1989	8140.21.200	4	G 41
DAILY II Camionnette/Kombi	29 L 10 V (ALJA43A2, ALJA42A2, ALJA41A2)	2287	70	09.2002		F1AE0481A	4	G 9
	29 L 12 V (ALKA41A2, ALLA52A2, ALKA42A2)	2287	85	09.2002		F1AE0481B	4	G 9
	29 L 14	2287	100	01.2005	04.2006	F1AE0481M	4	G 9
	29 L 9 V	2798	62	05.1999		8140.63.	4	G 62
	35 C 12 V, 35 S 12 V (AGKA43A2, AGKB43A2, AGKB46A2, AGKC43A2)	2287	85	09.2002		F1AE0481B	4	G 9
	35 C 14	2998	100	09.2004	04.2006	F1CE0481A	4	G 9
	35 C 14, 35 S 14	2287	100	01.2005	04.2006	F1AE0481M	4	G 9
	35 C 17, 35 S 17	2998	122	01.2005	04.2006	F1CE0481B	4	G 9
	35 S 10 (ANJA41A1, ANJA42A2, ANJA42AB, ANJA43A, ANJAV1A, AGJ)	2287	70	09.2002		F1AE0481A	4	G 9
	35 S 15 V, 35 C 15 V (A6HCV3B2, A6HBV4B2, A6HC41B2, A6HC42B2)	2798	107	11.2002		8140.43N	4	G 62
	35 S 9 V, 35 C 9 V	2798	62	05.1999		8140.63.	4	G 62
	40 C 14	2998	100	09.2004	04.2006	F1CE0481A	4	G 9
	40 C 14	2287	100	01.2005	04.2006	F1AE0481M	4	G 9
	40 C 17, 40 S 17	2998	122	01.2005	04.2006	F1CE0481B	4	G 9
	50 C 14	2998	100	09.2004	04.2006	F1CE0481A	4	G 9
	50 C 17	2998	122	09.2004	04.2006	F1CE0481B	4	G 9
	65 C 14	2998	100	09.2004	04.2006	F1CE0481A	4	G 9

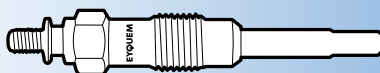



kW



Cyl.



IVECO

	65 C 17	2998	122	09.2004	04.2006	F1CE0481B	4	G 9
DAILY II Camion/Plate-forme	29 L 10 (ALJAV1A1, ALJA41AA, ALJA41A1, AHJA64A1, AHJA14A1, A	2287	70	09.2002		F1AE0481A	4	G 9
	29 L 12 (ALKA41A1, AHKA64A1, ALLA51A1)	2287	85	09.2002		F1AE0481B	4	G 9
	29 L 14 (AHRA11C1B1, AHRA14C1B1, AHRA64C1B1)	2287	100	11.2005		F1AE0481M	4	G 9
	29 L 9	2798	62	05.1999		8140.63.	4	G 62
	35 C 10 V, 35 S 10 V (AMJA11A1, AMJA14A1, AMJA64A1, AMJAG5A	2287	70	09.2002		F1AE0481A	4	G 9
	35 C 12, 35 S 12 (AEKA14A1, AEKA14AA, AEKA64A1, AEKB11A1, A	2287	85	09.2002		F1AE0481B	4	G 9
	35 C 14	2998	100	09.2004	04.2006	F1CE0481A	4	G 9
	35 C 14, 35 S 14	2287	100	01.2005	04.2006	F1AE0481M	4	G 9
	35 C 15	2798	107	11.2001		8140.43N	4	G 62
	35 C 17, 35 S 17	2998	122	01.2005	04.2006	F1CE0481B	4	G 9
	35 S 9, 35 C 9	2798	62	05.1999		8140.63.	4	G 62
	40 C 14	2998	100	09.2004	04.2006	F1CE0481A	4	G 9
	40 C 14	2287	100	01.2005	04.2006	F1AE0481M	4	G 9
	40 C 17, 40 S 17	2998	122	01.2005	04.2006	F1CE0481B	4	G 9
	50 C 14	2998	100	09.2004	04.2006	F1CE0481A	4	G 9
	50 C 15	2798	107	01.2001		8140.43N	4	G 62
	50 C 17	2998	122	09.2004	04.2006	F1CE0481B	4	G 9
	65 C 14	2998	100	09.2004	04.2006	F1CE0481A	4	G 9
	65 C 15	2798	107	11.2001		8140.43N	4	G 62
	65 C 17	2998	122	09.2004	04.2006	F1CE0481B	4	G 9
DAILY III Camionnette/Kombi	29L10 V	2287	70	05.2006		F1AE0481FA	4	G 9
	29L12 V, 29L12 V/P	2287	85	05.2006		F1AE0481GA	4	G 9
	29L14 C, 29L14 C/P, 29L14 V, 29L14 V/P	2287	100	05.2006		F1AE0481HA	4	G 9
	35C10, 35S10	2287	70	05.2006		F1AE0481FA	4	G 9
	35C11 V, 35S11 V	2287	78	07.2007		F1AE0481FA	4	G 9
	35C12 V, 35C12 V/P, 35S12 V, 35S12 V/P	2287	85	05.2006		F1AE0481GA	4	G 9
	35C13 V, 35C13 V/P, 35S13 V, 35S13 V/P	2287	93	07.2007		F1AE0481GA	4	G 9
	35C14 V, 35C14 V/P, 35S14 V, 35S14 V/P	2998	103	07.2007		F1CE3481LC	4	G 9
	35C15 V, 35C15 V/P	2998	107	05.2006		F1CE0481FA	4	G 9
	35C17 V, 35C17 V/P, 35S17 V, 35S17 V/P	2998	125	07.2007		F1CE0481HA	4	G 9
	35C18 V, 35C18 V/P, 35S18 V, 35S18 V/P	2998	130	05.2006		F1CE0481HA	4	G 9
	35S14 C, 35S14 C/P, 35S14 V, 35S14 V/P, 35C14 V, 35C14 V/P	2287	100	05.2006		F1AE0481HA	4	G 9
	40C10 V	2287	70	05.2006		F1AE0481FA	4	G 9
	40C11 V	2287	78	07.2007		F1AE0481FA	4	G 9
	40C12 V, 40C14 V/P	2287	85	05.2006		F1AE0481GA	4	G 9
	40C13 V, 40C13 V/P	2287	93	07.2007		F1AE0481GA	4	G 9
	40C14 V, 40C14 V/P, 40S14 V, 40S14 V/P	2998	103	07.2007		F1CE3481LC	4	G 9
	40C15 V, 40C15 V/P	2998	107	05.2006		F1CE0481FA	4	G 9
	40C17 V, 40C17 V/P	2998	125	07.2007		F1CE0481HA	4	G 9
	40C18 V, 40C18 V/P	2998	130	05.2006		F1CE0481HA	4	G 9
	45C15 V	2998	107	05.2006		F1CE0481FA	4	G 9
	45C17 V, 45C17 V/P	2998	125	07.2007		F1CE0481HA	4	G 9
	45C18	2998	130	05.2006		F1CE0481HA	4	G 9
	50C14 V, 50C14 V/P	2998	103	07.2007		F1CE3481LC	4	G 9
	50C15	2998	107	05.2006		F1CE0481FA	4	G 9
	50C17 V, 50C17 V/P	2998	125	07.2007		F1CE0481HA	4	G 9
	50C18	2998	130	05.2006		F1CE0481HA	4	G 9
	60C15 V	2998	107	05.2006		F1CE0481FA	4	G 9





kW



Cyl.



IVECO

	60C17 V, 60C17 V/P	2998	125	07.2007	F1CE0481HA	4	G 9
	60C18	2998	130	05.2006	F1CE0481HC	4	G 9
	65C14 V, 65C14 V/P	2998	103	07.2007	F1CE3481LC	4	G 9
	65C15	2998	107	05.2006	F1CE0481FA	4	G 9
	65C17 V, 65C17 V/P	2998	125	07.2007	F1CE0481HA	4	G 9
	65C18	2998	130	05.2006	F1CE0481HC	4	G 9
	70C14 V, 70C14 V/P	2998	103	07.2007	F1CE3481LC	4	G 9
	70C17V, 70C17 V/P	2998	125	07.2007	F1CE0481HA	4	G 9
DAILY III Kipper	35C10 K	2287	70	05.2006	F1AE0481FA	4	G 9
	35C11 K, 35C11 DK, 35S11 K, 35S11 DK	2287	78	07.2007	F1AE0481FA	4	G 9
	35C12	2287	85	05.2006	F1AE0481GA	4	G 9
	35C13 K, 35C13 DK, 35S13 K, 35S13 DK	2287	93	07.2007	F1AE0481GA	4	G 9
	35C14 K, 35C14 DK, 35S14 K, 35S14 DK	2998	103	07.2007	F1CE3481LC	4	G 9
	35C15	2998	107	05.2006	F1CE0481FA	4	G 9
	35C17 K, 35C17 DK, 35S17 K, 35S17 DK	2998	125	07.2007	F1CE0481HA	4	G 9
	35C18	2998	130	05.2006	F1CE0481HA	4	G 9
	35S14 K, 35S14 DK	2287	100	07.2007	F1AE0481HA	4	G 9
	40C14 K, 40C14 DK, 40S14 K, 40S14 DK	2998	103	07.2007	F1CE3481LC	4	G 9
	40C17 K, 40C17 DK	2998	125	07.2007	F1CE0481HA	4	G 9
	50C14 K, 50C14 DK	2998	103	07.2007	F1CE3481LC	4	G 9
	50C15	2998	107	05.2006	F1CE0481FA	4	G 9
	50C17 K, 50C17 DK	2998	125	07.2007	F1CE0481HA	4	G 9
	50C18	2998	130	05.2006	F1CE0481HA	4	G 9
	60C14 K, 60C14 DK	2998	103	07.2007	F1CE3481LC	4	G 9
	60C15	2998	107	05.2006	F1CE0481FA	4	G 9
	60C17 K, 60C17 DK	2998	125	07.2007	F1CE0481HA	4	G 9
	60C18	2998	130	05.2006	F1CE0481HC	4	G 9
	65C14 K, 65C14 DK	2998	103	07.2007	F1CE3481LC	4	G 9
	65C17 K, 65C17 DK, 65C17KK	2998	125	07.2007	F1CE0481HA	4	G 9
	70C14 K, 70C14 DK, 70C14 KK	2998	103	07.2007	F1CE3481LC	4	G 9
	70C17 K, 70C17 DK, 70C17 KK	2998	125	07.2007	F1CE0481HA	4	G 9
DAILY III Camion/Plate-forme	29L10	2287	70	05.2006	F1AE0481FA	4	G 9
	29L12	2287	85	05.2006	F1AE0481GA	4	G 9
	29L14	2287	100	05.2006	F1AE0481HA	4	G 9
	35C10, 35S10	2287	70	05.2006	F1AE0481FA	4	G 9
	35C11, 35S11, 35S11 D	2287	78	07.2007	F1AE0481FA	4	G 9
	35C12, 35S12	2287	85	05.2006	F1AE0481GA	4	G 9
	35C13, 35C13 /P, 35S13 D, 35S13, 35S13 /P	2287	93	07.2007	F1AE0481GA	4	G 9
	35C14, 35C14 /P, 35S14, 35S14 /P, 35S14 D, 35S14 D/P	2998	103	07.2007	F1CE3481LC	4	G 9
	35C15	2998	107	05.2006	F1CE0481FA	4	G 9
	35C17, 35C17 /P, 35S17, 35S17 /P, 35S17 D	2998	125	07.2007	F1CE0481HA	4	G 9
	35C18, 35S18	2998	130	05.2006	F1CE0481HA	4	G 9
	35S14	2287	100	05.2006	F1AE0481HA	4	G 9
	35S17 W, 35S17 WD	2998	125	07.2007	F1CE0481HA	4	G 9
	40C10, 40S10	2287	70	05.2006	F1AE0481FA	4	G 9
	40C11, 40C11 D, 40S11, 40S11 D	2287	78	07.2007	F1AE0481FA	4	G 9
	40C12	2287	85	05.2006	F1AE0481GA	4	G 9
	40C13, 40C13 /P, 40S13 D, 40S13, 40S13 /P	2287	93	07.2007	F1AE0481GA	4	G 9
	40C14, 40C14 /P, 40S14, 40S14 /P, 40S14 D, 40S14 D/P	2998	103	07.2007	F1CE3481LC	4	G 9
	40C15	2998	107	05.2006	F1CE0481FA	4	G 9
	40C17, 40C17 /P, 40S17, 40S17 /P, 40S17 D	2998	125	07.2007	F1CE0481HA	4	G 9
	40C18	2998	130	05.2006	F1CE0481HA	4	G 9
	45C14, 45C14 /P	2998	103	07.2007	F1CE3481LC	4	G 9
	45C15	2998	107	05.2006	F1CE0481FA	4	G 9

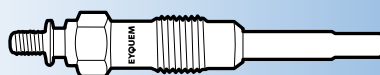



kW

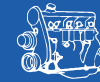

Cyl.



IVECO

45C17, 45C17 /P	2998	125	07.2007		F1CE0481HA	4	G 9
45C18, 45C18 /P, 45C18 D, 45C18 D/P	2998	130	05.2006		F1CE0481HA	4	G 9
50C14, 50C14 /P	2998	103	07.2007		F1CE3481LC	4	G 9
50C15	2998	107	05.2006		F1CE0481FA	4	G 9
50C17, 50C17 /P	2998	125	07.2007		F1CE0481HA	4	G 9
50C18	2998	130	05.2006		F1CE0481HA	4	G 9
55S17 W, 55S17 WD	2998	125	07.2007		F1CE0481HA	4	G 9
60C14, 60C14 /P	2998	103	07.2007		F1CE3481LC	4	G 9
60C15, 60C15 /P, 60C15 D, 60C15 D/P	2998	107	05.2006		F1CE0481FA	4	G 9
60C17, 60C17 /P	2998	125	07.2007		F1CE0481HA	4	G 9
60C18	2998	130	05.2006		F1CE0481HC	4	G 9
65C14, 65C14 /P	2998	103	07.2007		F1CE3481LC	4	G 9
65C15, 65C15 /P, 65C15 D, 65C15 D/P	2998	107	05.2006		F1CE0481FA	4	G 9
65C17, 65C17 /P	2998	125	07.2007		F1CE0481HA	4	G 9
65C18	2998	130	05.2006		F1CE0481HC	4	G 9
70C14, 70C14 /P	2998	103	07.2007		F1CE3481LC	4	G 9
70C17, 70C17 /P	2998	125	07.2007		F1CE0481HA	4	G 9

JAGUAR

S-TYPE (CCX)	2.7 D	2720	152	06.2004			6	G 5
XF (X250)	NEW 2.2 D	2179	120	04.2011	04.2015	224DT	4	G 88
	NEW 2.2 D	2179	140	05.2011	04.2015	224DT	4	G 88
	NEW 2.2 D	2179	147	03.2012	04.2015	224DT	4	G 88
XF SPORTBAKE (X250)	NEW 2.2 D	2179	120	09.2012	04.2014	224DT	4	G 88
	NEW 2.2 D	2179	147	09.2012	04.2014	224DT	4	G 88
XJ (X350, X358)	6 2,7 D	2720	152	10.2005			6	G 5
X-TYPE (CF1)	2.0 D	1998	96	07.2003	10.2005	R4-X404	4	G 65

JEEP

CHEROKEE (XJ)	2.1 TD	2068	64	10.1984		J8S	4	G 27
	2.1 TD	2068	59	06.1989	03.1992	J8S	4	G 27
	2.5	2469	89	10.1995			4	G 40
	2.5 TD	2499	85	01.1988			4	G 40
	2.5 TD	2499	85	01.1988			4	G 41
	2.5 TD	2499	85	01.1988			4	G 40
	2.5 TD	2499	85	01.1988			4	G 41
GRAND CHEROKEE I (Z)	2.5 TD (Z)	2499	85	10.1995	04.1999	M52/M51	4	G 40
GRAND CHEROKEE II (WJ, WG)	2.7 CRD 4x4	2685	120	10.2001			5	G 19
	3.1 TD	3125	103	04.1999			5	G 40
GRAND CHEROKEE III (WH, WK)	NEW 3.0 CRD 4x4	2987	160	04.2006	12.2010	EXL	6	GPE 83
	NEW 3.0 CRD 4x4	2987	155	04.2006	12.2010	EXL	6	GPE 83
COMMANDER (XK)	NEW 3.0 CRD	2987	160	04.2006	12.2010	EXL	6	GPE 83

KIA

BESTA Bus	2.2 D	2184	48	07.1992	10.1997	R2	4	G 1
BESTA Camionnette	2.2 D	2184	48	02.1996	07.1999	R2	4	G 1
CARENS II (FJ)	2.0 CRDi	1991	83	07.2002		D4EA	4	G 25
	2.0 CRDi	1991	103	11.2005		D4EA-F	4	G 25
CARENS III (UN)	NEW 1.6 CRDi 110	1582	85	10.2010		D4FB	4	G 85
	NEW 1.6 CRDi 128	1582	94	10.2010		D4FB	4	G 85
	2.0 CRDi 115	1991	85	05.2007		D4EA	4	G 25
	2.0 CRDi 135	1991	100	08.2009		D4EA	4	G 25
	2.0 CRDi 140	1991	103	09.2006		D4EA-F	4	G 25
CARNIVAL I (UP)	2.9 TD	2903	93	08.1999	10.2001	J3	4	G 25
CARNIVAL II (GQ)	2.9 CRDi	2902	106	10.2001	06.2006	J3	4	G 25
CEE'D (ED)	NEW 1.6 CRDi 90	1582	66	12.2006	12.2012	D4FB-L	4	G 85
	NEW 1.6 CRDi 115	1582	85	12.2006	12.2012	D4FB	4	G 85
	NEW 1.6 CRDi 128	1582	94	10.2010	12.2012	D4FB	4	G 85
	2.0 CRDi	1991	100	06.2007	12.2012	D4EA	4	G 25
	2.0 CRDi 140	1991	103	09.2007	12.2012	D4EA-F	4	G 25
CEE'D SW (ED)	NEW 1.6 CRDi 90	1582	66	09.2007	12.2012	D4FB-L	4	G 85
	NEW 1.6 CRDi 115	1582	85	09.2007	12.2012	D4FB	4	G 85

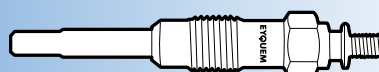



kW



Cyl.



KIA

	NEW	1.6 CRDi 128	1582	94	10.2010	12.2012	D4FB	4	G 85
		2.0 CRDi 140	1991	103	09.2007	12.2012	D4EA-F	4	G 25
CEE'D (JD)	NEW	1.4 CRDi 90	1396	66	05.2012		D4FC	4	G 85
	NEW	1.6 CRDi 90	1582	66	05.2012		D4FB-L	4	G 85
	NEW	1.6 CRDi 110	1582	81	05.2012		D4FB	4	G 85
	NEW	1.6 CRDi 128	1582	94	05.2012		D4FB	4	G 85
CEE'D Sportswagon (JD)	NEW	1.4 CRDi 90	1396	66	09.2012		D4FC	4	G 85
	NEW	1.6 CRDi 110	1582	81	03.2013		D4FB	4	G 85
	NEW	1.6 CRDi 128	1582	94	09.2012		D4FB	4	G 85
CERATO (LD)		1.5 CRDi	1493	75	07.2005		D4FA	4	G 25
	NEW	1.6 CRDi	1582	85	06.2005		D4FB	4	G 85
		2.0 CRDi	1991	83	04.2004		D4EA	4	G 25
CERATO A (LD)		1.5 CRDi	1493	75	07.2005		D4FA	4	G 25
	NEW	1.6 CRDi	1582	85	06.2005		D4FB	4	G 85
		2.0 CRDi	1991	83	04.2004		D4EA	4	G 25
K2500 (SD)		2.5 D	2476	69	01.2003	08.2003	D4BH	4	G 69
		2.5 D	2476	69	09.2003		D4BH	4	G 31
K2700 (SD)		2.7 D	2665	59	10.1999		J2	4	G 1
MAGENTIS (MG)		2.0 CRDi	1991	100	11.2005	12.2008	D4EA	4	G 25
		2.0 CRDi	1991	103	04.2006		D4EA-F	4	G 25
		2.0 CRDi	1991	110	04.2006		D4EA-F	4	G 25
PICANTO (BA)	NEW	1.1 CRDi	1120	55	11.2005		D3FA	3	G 85
PREGIO Camionnette (TB)		2.5 Tci D	2476	69	09.2002	08.2003	D4BH	4	G 69
		2.5 Tci D	2476	69	09.2003		D4BH	4	G 31
		2.7 D	2665	60	10.1997		J2	4	G 1
PRO CEE'D (ED)	NEW	1.6 CRDi 90	1582	66	11.2010	09.2012	D4FB-L	4	G 85
	NEW	1.6 CRDi 115	1582	85	02.2008	09.2012	D4FB	4	G 85
	NEW	1.6 CRDi 128	1582	94	10.2010	09.2012	D4FB	4	G 85
		2.0 CRDi 140	1991	103	02.2008	09.2012	D4EA-F	4	G 25
PRO CEE'D (JD)	NEW	1.4 CRDi 90	1396	66	03.2013		D4FC	4	G 85
	NEW	1.6 CRDi 110	1582	81	03.2013		D4FB	4	G 85
	NEW	1.6 CRDi 128	1582	94	03.2013		D4FB	4	G 85
RETONA (CE)		2.0 TD	1998	61	06.1999		RF	4	G 1
RIO II (JB)	NEW	1.5 CRDi	1493	65	06.2008		D4FA	4	G 85
	NEW	1.5 CRDi	1493	81	03.2005		D4FA	4	G 85
RIO II A (JB)	NEW	1.5 CRDi	1493	65	06.2008		D4FA	4	G 85
	NEW	1.5 CRDi	1493	81	03.2005		D4FA	4	G 85
RIO III (UB)	NEW	1.1 CRDi	1120	55	09.2011		D3FA OE n°36710 2A100	3	G 85
	NEW	1.4 CRDi	1396	66	09.2011		D4FC	4	G 85
SORENTO I (JC)		2.5 CRDi	2497	103	08.2002		D4CB	4	G 77
		2.5 CRDi	2497	120	05.2006		D4CB	4	G 77
		2.5 CRDi	2497	125	12.2006		D4CB	4	G 77
SOUL (AM)	NEW	1.6 CRDi 115	1582	85	02.2009		D4FB	4	G 85
	NEW	1.6 CRDi 128	1582	94	02.2009		D4FB	4	G 85
SOUL II (PS)	NEW	1.6 CRDi 128	1582	94	02.2014		D4FB	4	G 85
	NEW	1.6 CRDi 136	1582	100	04.2015		D4FB	4	G 85
SPORTAGE (K00)		2.0 TD 4WD	1998	61	10.1997	10.1998	RF	4	G 1
SPORTAGE II (JE_, KM_)		2.0 CRDi	1991	83	02.2005		D4EA	4	G 25
		2.0 CRDi	1991	100	01.2006		D4EA	4	G 25
		2.0 CRDi	1991	103	01.2006		D4EA-F	4	G 25
		2.0 CRDi	1991	110	09.2008		D4EA-F	4	G 25
		2.0 CRDi 4WD	1991	83	09.2004		D4EA	4	G 25
		2.0 CRDi 4WD	1991	100	01.2006		D4EA	4	G 25
		2.0 CRDi 4WD	1991	103	01.2006		D4EA-V/D4EA-F	4	G 25
		2.0 CRDi 4WD	1991	110	09.2008		D4EA-F	4	G 25
VENGA (YN)	NEW	1.4 CRDi 75	1396	55	02.2010		D4FC	4	G 85
	NEW	1.4 CRDi 75	1396	57	02.2010		D4FC	4	G 85
	NEW	1.4 CRDi 90	1396	66	02.2010		D4FC	4	G 85
	NEW	1.6 CRDi 115	1582	85	02.2010		D4FB	4	G 85
	NEW	1.6 CRDi 128	1582	94	02.2010		D4FB	4	G 85

LADA

NVA (2121)		1900 Diesel	1905	47	01.1993		XUD9A	4	G 41
		1900 Diesel	1905	47	01.1993		XUD9A	4	G 41
		1900 Diesel	1905	55	01.1999		XUD9SD	4	G 41





kW



Cyl.



LADA

1900 Diesel	1905	47	01.1993		XUD9A	4	G 41
-------------	------	----	---------	--	-------	---	------

LANCIA

DEDRA (835)	1.9 TDS (835EE, 835EF)	1929	66	04.1989	07.1999	835 A4.000/835 A4.046/160 D1.000	4	G 41
	1.9 TDS (835EE, 835EF)	1929	66	04.1989	07.1999	835 A4.000/835 A4.046/160 D1.000	4	G 41
	1.9 TDS (835EE, 835EF)	1929	66	04.1989	07.1999	835 A4.000/835 A4.046/160 D1.000	4	G 41
	1.9 TDS (835EE, 835EF)	1929	66	04.1989	07.1999	835 A4.000/835 A4.046/160 D1.000	4	G 41
	1.9 TDS (835EE, 835EF)	1929	66	04.1989	07.1999	835 A4.000/835 A4.046/160 D1.000	4	G 41
	1.9 TDS (835EE, 835EF)	1929	66	04.1989	07.1999	835 A4.000/835 A4.046/160 D1.000	4	G 41
	1.9 TDS (835EE, 835EF)	1929	66	04.1989	07.1999	835 A4.000/835 A4.046/160 D1.000	4	G 41
	1.9 TDS (835EE, 835EF)	1929	66	04.1989	07.1999	835 A4.000/835 A4.046/160 D1.000	4	G 41
	1.9 TDS (835EE, 835EF)	1929	66	04.1989	07.1999	835 A4.000/835 A4.046/160 D1.000	4	G 41
DEDRA SW (835)	1.9 TDS (835EE, 835EF)	1929	66	07.1994	07.1999	835 A4.000/160 D1.000	4	G 41
	1.9 TDS (835EE, 835EF)	1929	66	07.1994	07.1999	835 A4.000/160 D1.000	4	G 41
	1.9 TDS (835EE, 835EF)	1929	66	07.1994	07.1999	835 A4.000/160 D1.000	4	G 41
	1.9 TDS (835EE, 835EF)	1929	66	07.1994	07.1999	835 A4.000/160 D1.000	4	G 41
	1.9 TDS (835EE, 835EF)	1929	66	07.1994	07.1999	835 A4.000/160 D1.000	4	G 41
	1.9 TDS (835EE, 835EF)	1929	66	07.1994	07.1999	835 A4.000/160 D1.000	4	G 41
	1.9 TDS (835EE, 835EF)	1929	66	07.1994	07.1999	835 A4.000/160 D1.000	4	G 41
	1.9 TDS (835EE, 835EF)	1929	66	07.1994	07.1999	835 A4.000/160 D1.000	4	G 41
	1.9 TDS (835EE, 835EF)	1929	66	07.1994	07.1999	835 A4.000/160 D1.000	4	G 41
DELTA I (831AB0)	1.9 Turbo DS (831AB.021)	1929	59	10.1986	12.1989	831 D1.000	4	G 41
	1.9 Turbo DS (831AB.021)	1929	59	10.1986	12.1989	831 D1.000	4	G 41
	1.9 Turbo DS (831AB.021)	1929	59	10.1986	12.1989	831 D1.000	4	G 41
DELTA II (836)	1.9 TD (836AM, 836AN)	1929	66	10.1994	08.1999	835 A4.000/160 D1.000	4	G 41
	1.9 TD (836AM, 836AN)	1929	66	10.1994	08.1999	835 A4.000/160 D1.000	4	G 41
	1.9 TD (836AM, 836AN)	1929	66	10.1994	08.1999	835 A4.000/160 D1.000	4	G 41
DELTA III (844)	NEW 1.6 D Multijet	1598	77	04.2011		944 A3.000	4	GPE 82
	NEW 1.6 D Multijet	1598	85	08.2008		955 A4.000	4	GPE 82
	NEW 1.6 D Multijet	1598	88	09.2008		198 A2.000	4	GPE 82
	NEW 1.9 D Multijet	1910	140	01.2009		844 A1.000	4	GPE 82
	NEW 2.0 D Multijet	1956	120	09.2008		844 A2.000	4	GPE 82
	NEW 2.0 D Multijet	1956	121	09.2008		198 A5.000/ 198 A8.000	4	GPE 82
KAPPA (838A)	2.4 JTD (838AL1AA)	2387	100	06.1998	10.2001	838 A8.000	5	G 60
	2.4 TDS (838AE1AA, 838AH1AA)	2387	91	08.1994	10.2001	838 A7.000/838 A3.000	5	G 39
KAPPA SW (838B)	2.4 JTD (838BL1AA)	2387	100	06.1998	10.2001	838 A8.000	5	G 60
	2.4 TDS (838BH1AA)	2387	91	07.1996	10.2001	838 A7.000/838 A3.000	5	G 39
LYBRA (839AX)	1.9 JTD	1910	85	05.2001		937 A2.000	4	G 60
	1.9 JTD (839AXD1A)	1910	77	07.1999	09.2000	AR 32302	4	G 60
	1.9 JTD (839AXI1A)	1910	81	09.2000	05.2001	AR 37101	4	G 60
	2.4 JTD	2387	110	05.2002		841 C.000	5	G 60
	2.4 JTD (839AXE1A)	2387	99	07.1999	09.2000	AR 32501/839 A5.000	5	G 60
	2.4 JTD (839AXL1A)	2387	103	09.2000	05.2002	839 A6.000	5	G 60
LYBRA SW (839BX)	1.9 JTD	1910	85	05.2001		937 A2.000	4	G 60
	1.9 JTD (839BXD1A)	1910	77	07.1999	09.2000	AR 32302	4	G 60
	1.9 JTD (839BXI1A)	1910	81	09.2000	05.2001	AR 37101	4	G 60
	2.4 JTD	2387	110	05.2002		841 C.000	5	G 60
	2.4 JTD (839BXE1A)	2387	99	10.1999	09.2000	AR 32501/839 A5.000	5	G 60
	2.4 JTD (839BXL1A)	2387	103	09.2000		839 A6.000	5	G 60
MUSA (350)	1.3 D Multijet	1248	51	10.2004		188 A9.000	4	G 7
	1.3 D Multijet	1248	66	09.2006		199 A3.000	4	G 7
	NEW 1.3 D Multijet	1248	70	03.2009		199 B1.000	4	GPE 80
	NEW 1.6 D Multijet	1598	85	07.2008		350 A2.000/ 350 A3.000	4	GPE 82
	NEW 1.6 D Multijet	1598	88	07.2008		350 A2.000	4	GPE 82
	1.9 D Multijet	1910	74	10.2004		188 B2.000	4	G 60
PHEDRA (179_)	2.0 D Multijet	1997	100	07.2006		RHR	4	G 30
	2.0 JTD	1997	79	07.2003		RHM	4	G 57
	2.0 JTD	1997	88	06.2006		RHK	4	G 30
	2.0 JTD (179AXB1A)	1997	80	09.2002		RHW(DW10ATED4)	4	G 57
	2.2 JTD (179AXC1A)	2179	94	09.2002		4HW(DW12ATED4)	4	G 57
	NEW 2.2 D Multijet	2179	125	03.2008	11.2010	4HS/4HT	4	G 88
	NEW 2.2 JTD	2179	120	04.2006	11.2010	4HP/4HR	4	G 88
PRISMA (831AB0)	1.9 Diesel	1911	48	01.1983	02.1992	831 D.000	4	G 41
	1.9 Diesel	1911	48	01.1983	02.1992	831 D.000	4	G 41
	1.9 Diesel	1911	48	01.1983	02.1992	831 D.000	4	G 41
	1.9 Turbo Diesel	1928	59	05.1985	12.1989	831 D1.000	4	G 41
	1.9 Turbo Diesel	1928	59	05.1985	12.1989	831 D1.000	4	G 41





kW



Cyl.



LANCIA

	1.9 Turbo Diesel	1928	59	05.1985	12.1989	831 D1.000	4	G 41
THEMA (834)	2500 Turbo D (834D)	2445	74	11.1984	09.1988	8144.91	4	G 41
	2500 Turbo D (834D)	2445	74	11.1984	09.1988	8144.91	4	G 41
	2500 Turbo D (834D)	2445	74	11.1984	09.1988	8144.91	4	G 41
	2500 Turbo DS (834AE)	2499	85	06.1988	05.1992	8144.97	4	G 41
	2500 Turbo DS (834AE)	2499	85	06.1988	05.1992	8144.97	4	G 41
	2500 Turbo DS (834AE)	2499	85	06.1988	05.1992	8144.97	4	G 41
THEMA SW (834)	2500 Turbo DS (834AM)	2500	77	05.1988	07.1992	8144.97S	4	G 41
	2500 Turbo DS (834AE)	2499	85	06.1988	05.1992	8144.97	4	G 41
	2500 Turbo DS (834AM)	2500	77	05.1988	07.1992	8144.97S	4	G 41
	2500 Turbo DS (834D)	2445	74	03.1987	09.1990	8144.91	4	G 41
	2500 Turbo DS (834D)	2445	74	03.1987	09.1990	8144.91	4	G 41
THESIS (841AX)	2.4 JTD	2387	129	05.2003		841 G.000	5	G 8
	2.4 JTD (841AXD1B02)	2387	110	07.2002		841 C.000	5	G 60
YPSILON (843)	1.3 D Multijet	1248	55	09.2006		199 A2.000	4	G 7
	NEW 1.3 D Multijet	1248	55	09.2006	12.2011	199 A2.000	4	GPE 80
	1.3 D Multijet	1248	66	09.2006		199 A3.000	4	G 7
	1.3 JTD	1248	51	10.2003		188 A9.000	4	G 7
YPSILON (846)	NEW 1.3 D Multijet	1248	70	05.2011		199 B1.000	4	GPE 80
ZETA (220)	2.0 JTD	1997	80	04.2000	09.2002	RHZ	4	G 57
	2.0 JTD (220AN5)	1997	80	09.1999	09.2002	RHW	4	G 57
	2.1 TD (220AJ5)	2088	80	05.1996	09.1999	P 8 C	4	G 41

LAND ROVER

88/109	2.3 D (LR 88 DL, LR 109 DL)	2286	46	09.1963	12.1986		4	G 41
	2.3 D (LR 88 DL, LR 109 DL)	2286	46	09.1963	12.1986		4	G 41
	2.3 D (LR 88 DL, LR 109 DL)	2286	46	09.1963	12.1986		4	G 41
	2.3 D (LR 88 DL, LR 109 DL)	2286	46	09.1963	12.1986		4	G 41
88/109 Hardtop	2.3 D (LR 88 DP, LR 109 DP)	2286	46	09.1963	12.1986		4	G 41
	2.3 D (LR 88 DP, LR 109 DP)	2286	46	09.1963	12.1986		4	G 41
	2.3 D (LR 88 DP, LR 109 DP)	2286	46	09.1963	12.1986		4	G 41
	2.3 D (LR 88 DP, LR 109 DP)	2286	46	09.1963	12.1986		4	G 41
90/110 (DHMC)	2.5 TD	2494	63	09.1986	07.1990		4	G 41
	2.5 TD	2494	63	09.1986	07.1990		4	G 41
	2.5 TD	2494	63	09.1986	07.1990		4	G 41
DEFENDER (LD)	2.5 90 TDI	2495	83	09.1990		16 L/23 L/11 L	4	G 13
	2.5 Td5 4WD	2495	90	06.1998			5	G 13
DEFENDER Pick-up (LD_)	2.5 Td5 4WD	2495	90	06.1998			5	G 13
DEFENDER Station Wagon (LD)	2.5 90,110 TDI	2495	83	09.1990	12.1998	16 L/23 L/11 L	4	G 13
	2.5 Td5 4WD	2495	90	06.1998			5	G 13
DISCOVERY I (LJ, LG)	2.5 TDI	2496	83	10.1989	10.1998	19 L/21 L/17 L/12 L	4	G 13
DISCOVERY III (TAA)	2.7 TD	2720	140	07.2004		276DT	6	G 5
DICOVERY IV (LA)	2.7 TD 4x4	2720	140	09.2009		276DT	6	G 5
FREELANDER (LN)	2.0 DI	1994	72	02.1998	11.2000		4	G 36
	2.0 Td4	1951	80	11.2001			4	G 23
	2.0 Td4	1951	82	11.2000			4	G 23
FREELANDER Soft Top	2.0 DI	1994	72	02.1998			4	G 36
FREELANDER 2 (L359)	NEW 2.2 Ed4	2179	110	08.2010	10.2014	224DT (DW12BTED4)	4	G 88
	NEW 2.2 SD4 4x4	2179	140	08.2010	10.2014	224DT	4	G 88
	NEW 2.2 TD4 4x4	2179	110	10.2006	10.2014	224DT (DW12BTED4)	4	G 88
	NEW 2.2 TD4 4x4	2179	112	01.2007	10.2014	224DT chassis n°->AH999999	4	G 88
	NEW 2.2 TD4 4x4	2179	115	10.2006	10.2014	224DT chassis n°->AH999999	4	G 88
NEW 2.2 TD4 4x4	2179	118	10.2006	10.2014	224DT chassis n°->AH999999	4	G 88	
RANGE ROVER I (AE, AN, HAA, HAB, HAM, HBM, RE, RN)	2.4 Diesel	2376	78	04.1986	12.1990	11 A	4	G 2
RANGE ROVER II (LP)	2.5 D	2496	83	08.1994	03.2002	14 L	4	G 41
	2.5 D	2496	83	08.1994	03.2002	14 L	4	G 41
	2.5 D	2496	83	08.1994	03.2002	14 L	4	G 41
	2.5 TD	2497	100	07.1994	03.2002	25 6T (BMW)	6	G 41
	2.5 TD	2497	100	07.1994	03.2002	25 6T (BMW)	6	G 41
RANGE ROVER III (LM)	2.5 TD	2497	100	07.1994	03.2002	25 6T (BMW)	6	G 41
	3.0 TD 6	2926	130	03.2002			6	G 23
RANGE ROVER EVOQUE (L538)	3.6 TD 8	3628	200	04.2006		368DT	8	G 5
	NEW 2.2 D, 4x4	2179	110	06.2011		224DT	4	G 88

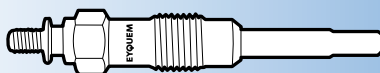



kW



Cyl.

**LAND ROVER**

	NEW 2.2 D 4x4	2179	140	06.2011		224DT	4	G 88
RANGE ROVER SPORT (LS)	2.7 TDVM	2720	140	02.2005			6	G 5

LDV

400 Bus	2.5 TD	2498	71	11.1995			4	G 41
	2.5 TD	2498	71	11.1995			4	G 41
	2.5 TD	2498	71	11.1995			4	G 41
400 Camionnette	2.5 TD	2498	71	11.1995			4	G 41
	2.5 TD	2498	71	11.1995			4	G 41
	2.5 TD	2498	71	11.1995			4	G 41
400 Camion/Plate-forme	2.5 TD	2498	71	11.1995			4	G 41
	2.5 TD	2498	71	11.1995			4	G 41
	2.5 TD	2498	71	11.1995			4	G 41

MAHIN

CJ 3	2.1 D	2112	46	10.1988	09.1992	XDP 290	4	G 41
	2.1 D	2112	46	10.1988	09.1992	XDP 290	4	G 41
	2.1 D	2112	46	10.1988	09.1992	XDP 290	4	G 41
	2.1 D	2112	46	10.1988	09.1992	XDP 290	4	G 41
	2.3 D	2345	28	10.1988	09.1992		4	G 41
	2.3 D	2345	28	10.1988	09.1992		4	G 41
	2.3 D	2345	28	10.1988	09.1992		4	G 41
	2.3 D	2345	28	10.1988	09.1992		4	G 41
	2.5 D	2523	29	10.1988	09.1992		4	G 41
	2.5 D	2523	29	10.1988	09.1992		4	G 41
	2.5 D	2523	29	10.1988	09.1992		4	G 41
	2.5 D	2523	29	10.1988	09.1992		4	G 41
CJ 3 Wagon	2.1 D	2112	46	10.1988	09.1992	XDP 290	4	G 41
	2.1 D	2112	46	10.1988	09.1992	XDP 290	4	G 41
	2.1 D	2112	46	10.1988	09.1992	XDP 290	4	G 41
	2.1 D	2112	46	10.1988	09.1992	XDP 290	4	G 41
	2.3 D	2345	28	10.1988	09.1992		4	G 41
	2.3 D	2345	28	10.1988	09.1992		4	G 41
	2.3 D	2345	28	10.1988	09.1992		4	G 41
	2.3 D	2345	28	10.1988	09.1992		4	G 41
	2.5 D	2523	29	10.1988	09.1992		4	G 41
	2.5 D	2523	29	10.1988	09.1992		4	G 41
	2.5 D	2523	29	10.1988	09.1992		4	G 41
	2.5 D	2523	29	10.1988	09.1992		4	G 41

MAZDA

121 III (JASM, JBSM)	1.8 D	1753	44	03.1996		RTJ/RTK	4	G 42
2 (DE)	1.4 MZR-CD	1399	50	01.2008	06.2015	Y404	4	G 6
	1.6 MZ-CD	1560	66	10.2008		Y646	4	G 6
	NEW 1.6 MZ-CD	1560	70	06.2011	06.2015	Y661/Y655	4	GPE 81
2 (DY)	1.4 CD	1399	50	04.2003		F6JA/F6JB	4	G 6
3 (BK)	NEW 1.6 MZ-CD	1560	66	06.2006	12.2009	Y406	4	G 72
3 A (BL)	NEW 1.6 MZR CD	1560	80	12.2008	05.2013	Y642	4	G 72
	NEW 1.6 MZR CD	1560	85	09.2010	05.2013	Y650/Y655	4	GPE 81
323 C IV (BG)	1.7 D	1720	41	08.1989	07.1994	PN54	4	G 1
323 III (BF)	1.7 D	1720	40	09.1986	05.1989	PN27	4	G 1
	1.7 D	1720	42	01.1987	05.1989	PN46	4	G 1
323 III Hatchback (BF)	1.7 D	1720	40	04.1986	05.1989	PN27	4	G 1
	1.7 D	1720	42	01.1987	05.1989	PN46	4	G 1
323 III Station Wagon (BW)	1.7 D	1720	40	11.1986	08.1987	PN26	4	G 1
	1.7 D	1720	41	10.1989	03.1993	PN26/PN54	4	G 1
	1.7 D	1720	42	11.1986	10.1989	PN26/PN54	4	G 1
323 P V (BA)	2.0 D	1998	52	10.1996		RF1G	4	G 1
323 S IV (BG)	1.7 D	1720	41	08.1989	07.1994	PN46/PN54/PN62	4	G 1
323 S V (BA)	1.6 TD	1686	60	05.1994	09.1998	4EE1-T	4	G 1
	2.0 D	1998	52	10.1996	09.1998	RF1G	4	G 1
5 (CW)	NEW 1.6 CD	1560	85	09.2010			4	GPE 81
626 II (GC)	2.0 D	1998	46	01.1983	06.1987	RF46	4	G 1
626 II Hatchback (GC)	2.0 D	1998	46	03.1984	06.1987	RF46	4	G 1
626 III (GD)	2.0 D	1998	44	07.1987	07.1991	RF-N	4	G 1





kW



Cyl.



MAZDA

626 III Hatchback (GD)	2.0 D	1998	44	07.1987	07.1991	RF-N	4	G 1
626 III Station Wagon (GV)	2.0 D	1998	44	09.1988	07.1991	RF-N	4	G 1
	2.0 D	1998	60	11.1994	09.1997	RF5	4	G 1
	2.0 D Complex	1998	55	05.1993	11.1996	RF-CX	4	G 1
626 IV (GE)	2.0 D GLX Complex	1998	55	10.1992	04.1997	RF OHC	4	G 1
626 IV Hatchback (GE)	2.0 D GLX Complex	1998	55	01.1993	04.1997	RF OHC	4	G 1
626 V (GF)	2.0 DTD	1998	66	04.1998	10.2002	RF3F	4	G 1
626 V Hatchback (GF)	2.0 DTD	1998	66	04.1998	10.2002	RF3F	4	G 1
B-SERIE (UF)	2.5 D 4WD	2500	57	09.1998	06.1999		4	G 1
	2.5 D 4WD	2500	63	02.1996	06.1999		4	G 1
B-SERIE (UN)	2.5 TD 4WD	2500	80	06.1999		MD25TI	4	G 1
E-SERIE Bus (SR1)	E2200 D	2169	46	01.1984	02.1988	R207	4	G 12
E-SERIE Camionnette (SR2)	2200 D 4WD	2184	47	03.1991	05.2003	R203/R207	4	G 12
	E2200 D	2184	47	03.1991	05.2003	R203/R207	4	G 12
	E2200 D	2184	46	05.1985	02.1988	R203/R207	4	G 12
MPV I (LV)	2.5 TD	2500	85	05.1996	09.1999		4	G 1

MERCEDES

100 Bus (631)	2.0 D	1988	45	09.1993	04.1996	OM 615.970	4	G 24
	D (631)	2399	41	12.1990	12.1994	OM 616	4	G 24
	D (631.333, 631.343, 631.334, 631.344)	2399	53	02.1988	05.1992	OM 616.963	4	G 24
	D (631.333, 631.343, 631.334, 631.344)	2399	55	12.1990	02.1996	OM 616/OM 616.963	4	G 24
100 Camionnette (631)	2.0 D	1988	45	09.1993	04.1996	OM 615.970	4	G 24
	D (631.332, 631.342)	2399	53	02.1988	01.1989	OM 616.963	4	G 41
	D (631.332, 631.342)	2399	53	02.1989	05.1992	OM 616.963	4	G 24
	D (631.332, 631.342)	2399	55	12.1990	02.1996	OM 616.963	4	G 24
100 Camion/Plate-forme (631)	D (631.340)	2399	53	02.1988	01.1989	OM 616.963	4	G 41
	D (631.340)	2399	53	02.1989	05.1992	OM 616.963	4	G 24
	D (631.340)	2399	55	12.1990	02.1996	OM 616.963	4	G 24
190 (W201)	D 2.0 (201.122)	1997	53	08.1983	01.1989	OM 601.911	4	G 41
	D 2.0 (201.122)	1997	53	02.1989	08.1989	OM 601.911	4	G 24
	D 2.0 (201.122)	1997	55	08.1989	08.1993	OM 601.911	4	G 24
	D 2.5 (201.126)	2497	66	04.1985	01.1989	OM 602.911	5	G 41
	D 2.5 (201.126)	2497	66	02.1989	08.1993	OM 602.911	5	G 24
	D 2.5 (201.126)	2497	69	08.1989	08.1993	OM 602.911	5	G 24
	Turbo-D 2.5 (201.128)	2497	90	02.1988	01.1989	OM 602.961	5	G 41
	Turbo-D 2.5 (201.128)	2497	90	02.1989	08.1993	OM 602.961	5	G 24
	Turbo-D 2.5 (201.128)	2497	93	02.1988	01.1989	OM 602.961	5	G 41
	Turbo-D 2.5 (201.128)	2497	93	02.1989	08.1993	OM 602.961	5	G 24
A-CLASS (W168)	A 160 CDI (168.007)	1689	44	07.1998	02.2001	OM 668.941	4	G 21
	A 160 CDI (168.006)	1689	55	02.2001	08.2004	OM 668.940	4	G 21
	A 170 CDI (168.008)	1689	66	07.1998	02.2001	OM 668.940	4	G 21
	A 170 CDI (168.009, 168.109)	1689	70	02.2001	08.2004	OM 668.942	4	G 21
A-CLASS (W169)	NEW A 160 CDI (169.006, 169.306)	1991	60	09.2004	06.2012	OM 640.942	4	GPE 83
	NEW A 180 CDI (169.007, 169.307)	1991	80	09.2004	06.2012	OM 640.940	4	GPE 83
	NEW A 200 CDI (169.308)	1991	100	09.2004	06.2012	OM 640.941	4	GPE 83
	NEW A 200 CDI (169.008, 169.308)	1991	103	09.2004	06.2012	OM 640.941	4	GPE 83
A-CLASS (W176)	NEW A 160 CDI / d (176.011)	1461	66	06.2013		OM 607.951	4	GPE 78
	NEW A 180 CDI / d (176.012)	1461	80	06.2012		OM 607.951	4	GPE 78
B-CLASS (W245)	NEW B 180 CDI (245.207)	1991	80	03.2005	11.2011	OM 640.940	4	GPE 83
	NEW B 200 CDI (245.208)	1991	103	03.2005	11.2011	OM 640.941	4	GPE 83
B-CLASS (W246, W242)	NEW B 160 CDI / d (246.211)	1461	66	05.2013		OM 607.951	4	GPE 78
	NEW B 180 CDI / d (246.212)	1461	80	02.2013		OM 607.951	4	GPE 78
C-CLASS (W202)	C 200 D (202.120)	1997	55	03.1993	05.2000	OM 601.913	4	G 24
	C 200 D (202.122)	1997	65	10.1996	05.2000	OM 604.915	4	G 61
	C 200 CDI (202.134)	2151	75	03.1998	05.2000	OM 611.960	4	G 19
	C 220 CDI (202.133)	2151	92	09.1997	05.2000	OM 611.960	4	G 19
	C 220 D (202.021)	2155	55	07.1996	05.2000	OM 604.910 (OE A001 159 15 01/16 01)	4	G 43
	C 220 D (202.021)	2155	55	07.1996	05.2000	OM 604.910 (OE A001 159 20 01/21 01)	4	G 61
	C 220 D (202.121)	2155	70	08.1993	01.1995	OM 604.910	4	G 43
	C 220 D (202.121)	2155	70	02.1995	05.2000	OM 604.910	4	G 61
	C 250 D (202.125)	2497	83	05.1993	05.2000	OM 605.910 (OE A001 159 15 01/16 01)	5	G 43
	C 250 D (202.125)	2497	83	05.1993	05.2000	OM 605.910 (OE A001 159 20 01/21 01)	5	G 61

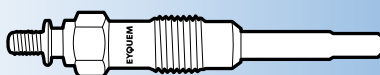



kW

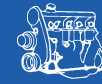

Cyl.



MERCEDES

	C 250 Turbo-D (202.128)	2497	110	10.1995	05.2000	OM 605.960	5	G 61
C-CLASS (W203)	C 200 CDI (203.004)	2148	75	02.2001	02.2007	OM 646.962	4	G 19
	C 200 CDI (203.004)	2148	85	09.2000	02.2007	OM 611.962	4	G 19
	C 200 CDI (203.007)	2148	90	04.2003	02.2007	OM 646.962	4	G 19
	C 220 CDI (203.006)	2148	100	05.2000	02.2007	OM 611.962	4	G 19
	C 220 CDI (203.006)	2148	105	05.2000	02.2007	OM 611.962	4	G 19
	C 220 CDI (203.008)	2148	110	02.2004	02.2007	OM 646.963	4	G 19
	C 270 CDI (203.016)	2685	125	12.2000	02.2007	OM 612.962	5	G 19
C-CLASS (W204)	NEW C 320 CDI (203.020)	2987	165	01.2005	02.2007	OM 642.910 (OE A001 159 50 01/71 01	6	GPE 83
	NEW C 320 CDI (204.022)	2987	165	01.2007	08.2013	OM 642.960 (OE A001 159 50 01/71 01	6	GPE 83
	NEW C 320 CDI 4-matic (204.089)	2987	165	01.2007	08.2013	OM 642.961 (OE A001 159 50 01/71 01	6	GPE 83
	NEW C 350 CDI (204.022)	2987	165	07.2009	08.2013	OM 642.960 (OE A001 159 50 01/71 01	6	GPE 83
C-CLASS (W205)	NEW C 350 CDI 4-matic (204.089)	2987	165	07.2009	08.2013	OM 642.961 (OE A001 159 50 01/71 01	6	GPE 83
	NEW C 180 BlueTEC / d (205.036)	1598	85	05.2014		OM 626.951	4	GPE 93
	NEW C 200 BlueTEC / d (205.037)	1598	100	05.2014		OM 626.951	4	GPE 93
C-CLASS Coupe (CL203)	C 200 CDI (203.707)	2148	90	03.2003	05.2008	OM 646.962	4	G 19
	C 220 CDI	2148	100	03.2001	01.2004	OM 611.962	4	G 19
	C 220 CDI (203.706)	2148	105	03.2001	01.2004	OM 611.962	4	G 19
	C 220 CDI (203.708)	2148	110	02.2004	05.2008	OM 646.963	4	G 19
C-CLASS Kombi (S202)	C 200 T D (202.180)	1997	65	10.1996	03.2001	OM 604.915	4	G 61
	C 200 T CDI (202.194)	2151	75	03.1998	03.2001	OM 611.960	4	G 19
	C 220 T CDI (202.193)	2151	92	09.1997	03.2001	OM 611.960	4	G 19
	C 220 T D (202.182)	2155	55	06.1996	03.2001	OM 604.910	4	G 61
	C 220 T D (202.182)	2155	70	06.1996	09.1998	OM 604.910 (OE A001 159 15 01/16 01)	4	G 43
	C 220 T D (202.182)	2155	70	06.1996	09.1998	OM 604.910 (OE A001 159 20 01/21 01)	4	G 61
	C 250 T Turbo-D (202.188)	2497	110	06.1996	03.2001	OM 605.960	5	G 61
C-CLASS T-Model (S203)	C 200 CDI (203.204, 203.207)	2148	75	03.2001	08.2007	OM 611.962 - OM 646.962	4	G 19
	C 200 CDI (203.204)	2148	85	03.2001	08.2007	OM 611.962	4	G 19
	C 200 CDI (203.207)	2148	90	04.2003	08.2007	OM 646.962	4	G 19
	C 220 CDI (203.208)	2148	100	08.2006	08.2007	OM 646.963	4	G 19
	C 220 CDI (203.206)	2148	105	03.2001	08.2007	OM 611.962	4	G 19
	C 220 CDI (203.208)	2148	110	02.2004	08.2007	OM 646.963	4	G 19
	C 270 CDI (203.216)	2685	125	03.2001	08.2007	OM 612.962	5	G 19
	NEW C 320 CDI (203.220)	2987	165	06.2005	08.2007	OM 642.910	6	GPE 83
	NEW C 320 CDI (204.222)	2987	165	08.2007	08.2013	OM 642.960 (OE A001 159 50 01/71 01	6	GPE 83
	NEW C 320 CDI (203.220)	2987	165	06.2005	08.2007	OM 642.910 (OE A001 159 50 01/71 01	6	GPE 83
C-CLASS T-Model (S204)	NEW C 320 CDI 4-matic (204.289)	2987	165	08.2007	08.2013	OM 642.961 (OE A001 159 50 01/71 01	6	GPE 83
	NEW C 180 BlueTEC / d (205.036)	1598	85	09.2014		OM 626.951	4	GPE 93
C-CLASS T-Model (S205)	NEW C 200 BlueTEC / d (205.037)	1598	100	09.2014		OM 626.951	4	GPE 93
	NEW C 200 BlueTEC / d (205.037)	1598	100	09.2014		OM 626.951	4	GPE 93
CITAN (415)	NEW 108 CDI (415.601, 415.603, 415.703)	1461	55	11.2012		OM 607.951	4	GPE 78
	NEW 109 CDI (415.601, 415.603, 415.605, 415.703)	1461	66	11.2012		OM 607.951	4	GPE 78
	NEW 111 CDI (415.603, 415.605, 415.703)	1461	81	06.2013		OM 607.951	4	GPE 78
CLA Coupe (C117)	NEW CLA 180 CDI / d (117.312)	1461	80	10.2013		OM 607.951	4	GPE 78
CLA Shooting Brake (X117)	NEW CLA 180 d (117.912)	1461	80	07.2015		OM 607.951	4	GPE 78
CLC-CLASS	CLC 200 CDI (203.707)	2148	90	05.2008	06.2011	OM 646.962	4	G 19
	CLC 220 CDI (203.708)	2148	110	05.2008	06.2011	OM 646.963	4	G 19
CLK Convertible (A209)	NEW CLK 320 CDI (209.420)	2987	165	03.2005	03.2010	OM 642.910 (OE A001 159 50 01/71 01	6	GPE 83
CLK (C209)	220 CDI (209.308)	2148	100	01.2005	05.2009	OM 646.966	4	G 19
	220 CDI (209.308)	2148	110	01.2005	05.2009	OM 646.966	4	G 19
	270 CDI (209.316)	2685	125	10.2002	05.2009	OM 612.967/OM 612.962	5	G 19
CLS (C219)	NEW 320 CDI (209.320)	2987	165	01.2005	05.2009	OM 642.910 (OE A001 159 50 01/71 01	6	GPE 83
	NEW CLS 320 CDI (219.322)	2987	165	01.2005	12.2010	OM 642.920 (OE A001 159 50 01/71 01	6	GPE 83
	NEW CLS 350 CDI (219.322)	2987	165	04.2009	12.2010	OM 642.920	6	GPE 83
COUPE (C123)	300 C Turbo-D (123.153)	2998	92	09.1981	07.1985	OM 617.952	5	G 41
E-CLASS (W124)	E 200 D (124.120)	1997	53	12.1984	01.1989	OM 601.912	4	G 41
	E 200 D (124.120)	1997	53	02.1989	08.1989	OM 601.912	4	G 24
	E 200 D (124.120)	1997	55	06.1993	06.1995	OM 601.912	4	G 24
	A 250 D (124.125)	2497	66	04.1985	01.1989	OM 602.912	5	G 41
	A 250 D (124.125)	2497	66	02.1989	06.1993	OM 602.912	5	G 24
	A 250 D (124.125)	2497	69	01.1989	01.1989	OM 602.912	5	G 41
	A 250 D (124.125)	2497	69	02.1989	06.1993	OM 602.912	5	G 24
	A 250 D (124.125)	2497	69	02.1989	06.1993	OM 602.912	5	G 24
	E 250 D (124.126, 124.129)	2497	83	07.1993	06.1995	OM 605.911	5	G 43





kW



Cyl.



MERCEDES

	E 250 Turbo-D (124.128)	2497	93	09.1988	01.1989	OM 602.962	5	G 41
	E 250 Turbo-D (124.128)	2497	93	02.1989	06.1993	OM 602.962	5	G 24
	E 250 Turbo-D (124.128)	2497	93	06.1993	06.1995	OM 602.962	5	G 24
	E 300 D (124.130)	2996	80	12.1984	01.1989	OM 603.912	5	G 41
	E 300 D (124.130)	2996	80	02.1989	08.1989	OM 603.912	5	G 24
	E 300 D 4-matic (124.330)	2996	80	09.1986	01.1989	OM 603.913	5	G 41
	E 300 D 4-matic (124.330)	2996	80	02.1989	08.1992	OM 603.913	5	G 24
	E 300 D (124.130)	2996	81	06.1990	06.1993	OM 603.912	5	G 24
	E 300 D - E 300 D 4-matic (124.330)	2996	83	08.1989	06.1993	OM 603.913	5	G 24
	E 300 D (124.131)	2996	100	07.1993	06.1995	OM 606.910	6	G 43
	E 300 Turbo-D/D 4-matic (124.133)	2996	105	09.1986	09.1988	OM 603.960 - OM 603.963	6	G 41
	E 300 Turbo-D/D 4-matic (124.133)	2996	108	01.1988	01.1989	OM 603.960	6	G 41
	E 300 Turbo-D/D 4-matic (124.133)	2996	108	06.1993	06.1995	OM 603.963	6	G 24
E-CLASS (W210)	E 200 D (210.003)	1997	65	01.1996	03.2002	OM 604.917	4	G 61
	E 200 CDI (210.007)	2151	75	06.1998	03.2002	OM 611.961	4	G 19
	E 200 CDI (210.007)	2148	85	07.1999	03.2002	OM 611.961	4	G 19
	E 220 D	2155	55	05.1996	03.2002	OM 604.912	4	G 61
	E 220 D (210.004)	2155	70	06.1995	07.1999	OM 604.912	4	G 61
	E 220 CDI (210.006)	2151	92	06.1998	07.1999	OM 611.961	4	G 19
	E 220 CDI (210.006)	2148	105	07.1999	03.2002	OM 611.961	4	G 19
	E 250 D (210.010)	2497	83	06.1995	07.1999	OM 605.912	5	G 61
	E 250 Turbo-D (210.015)	2497	110	06.1997	07.1999	OM 605.962	5	G 61
	E 270 CDI (210.016)	2685	125	07.1999	03.2002	OM 612.961	5	G 19
	E 290 Turbo-D (210.017)	2874	95	03.1996	07.1999	OM 602.982	5	G 53
	E 300 D (210.020)	2996	100	06.1995	06.1997	OM 606.912	6	G 61
	E 300 Turbo-D (210.025)	2996	130	12.1996	07.1999	OM 606.962	6	G 61
	E 320 CDI (210.026)	3226	145	07.1999	03.2002	OM 613.961	6	G 19
E-CLASS (W211)	E 200 CDI (211.004)	2148	75	07.2002	12.2008	OM 646.951	4	G 19
	E 200 CDI (211.004)	2148	90	07.2002	12.2008	OM 646.951	4	G 19
	E 220 CDI (211.006)	2148	100	03.2002	12.2008	OM 646.961	4	G 19
	E 220 CDI (211.006)	2148	110	03.2002	12.2008	OM 646.961	4	G 19
	E 220 CDI (211.006)	2149	120	03.2003	12.2008	OM 646.821	4	G 19
	E 270 CDI (211.016)	2685	130	03.2002	12.2008	OM 647.961	5	G 19
	E 280 CDI (211.023)	3222	130	05.2004	12.2008	OM 648.961	6	G 19
	NEW E 280 CDI (211.020)	2987	140	03.2005	12.2008	OM 642.920	6	GPE 83
	NEW E 280 CDI 4-matic	2987	140	03.2005	12.2008	OM 642.921	6	GPE 83
	NEW E 300 BlueTEC	2987	155	09.2007	12.2008	OM 642.920 not for SA code U43, U83	6	GPE 83
	E 320 CDI (211.026)	3222	150	11.2002	12.2008	OM 648.961 not for SA code 494	6	G 19
	NEW E 320 CDI (211.022)	2987	165	03.2005	12.2008	OM 642.920 not for SA code U43, U83	6	GPE 83
	NEW E 320 CDI 4-matic	2987	165	03.2005	12.2008	OM 642.910 not for SA code U43, U83	6	GPE 83
	E 400 CDI (211.028)	3996	191	02.2003	12.2008	OM 628.961	8	G 19
	NEW E 420 CDI (211.029)	3996	231	01.2006	12.2008	OM 629.910	8	GPE 83
E-CLASS Kombi (S124)	200 T D (124.180)	1997	53	09.1985	01.1989	OM 601.912	4	G 41
	200 T D (124.180)	1997	53	02.1989	08.1991	OM 601.912	4	G 24
	200 T D (124.180)	1997	55	09.1988	01.1989	OM 601.912	4	G 41
	200 T D (124.180)	1997	55	02.1989	08.1991	OM 601.912	4	G 24
	250 T D (124.185)	2497	66	09.1985	01.1989	OM 602.912	5	G 41
	250 T D (124.185)	2497	66	02.1989	06.1993	OM 602.912	5	G 24
	250 T D (124.185)	2497	69	01.1989	06.1993	OM 602.912	5	G 24
	250 T D (124.186)	2497	83	06.1993	06.1996	OM 605.911	5	G 43
	250 TD Turbo (124.188)	2497	93	03.1988	07.1993	OM 602.962	5	G 24
	250 TD Turbo (124.188)	2497	93	06.1993	06.1996	OM 602.962	5	G 24
	300 T D (124.190)	2996	80	09.1986	01.1989	OM 603.912	6	G 41
	300 T D (124.190)	2996	80	02.1989	06.1993	OM 603.912	6	G 24
	300 TD T (124.191)	2996	100	06.1993	05.1995	OM 606.910	6	G 43
	300 TD T (124.191)	2996	100	06.1995	06.1996	OM 606.910	6	G 61
	300 T D (124.190)	2996	81	01.1989	06.1993	OM 603.912	6	G 24
	300 T D (124.190)	2996	83	01.1989	06.1993	OM 603.912	6	G 24
	300 T Turbo-D	2996	105	09.1986	01.1989	OM 603.960 - OM 603.963	6	G 41
	300 T Turbo/D 4-matic (124.393)	2996	108	09.1986	01.1989	OM 603.960	6	G 41
	300 T Turbo/D 4-matic (124.193)	2996	108	02.1989	06.1996	OM 603.960	6	G 24
E-CLASS Kombi (S210)	E 220 T CDI (210.206)	2151	92	06.1998	07.1999	OM 611.961	4	G 19
	E 220 T CDI (210.206)	2148	105	07.1999	03.2003	OM 611.961	4	G 19
	E 250 T D (210.210)	2497	83	06.1996	07.1999	OM 605.912	5	G 61
	E 250 T Turbo-D (210.215)	2497	110	06.1997	07.1999	OM 605.962	5	G 61





kW



Cyl.



MERCEDES

	E 270 T CDI (210.216)	2685	125	07.1999	03.2003	OM 612.961	5	G 19
	E 290 T Turbo-D (210.217)	2874	95	06.1996	07.1999	OM 602.982	5	G 53
	E 300 T Turbo-D (210.225)	2996	130	12.1996	07.1999	OM 606.962	6	G 61
	E 320 T CDI (210.226)	3226	145	07.1999	03.2003	OM 613.961	6	G 19
E-CLASS T-Model (S211)	E 220 CDI (211.206)	2148	100	03.2003	07.2009	OM 646.961	4	G 19
	E 220 T CDI (211.206)	2148	110	03.2003	07.2009	OM 646.961	4	G 19
	E 220 T CDI (211.206)	2148	120	03.2003	07.2009	OM 646.821	4	G 19
	E 270 T CDI (211.216)	2685	130	03.2003	07.2009	OM 647.961	5	G 19
	E 280 T CDI (211.223)	3222	130	05.2004	07.2009	OM 648.961	6	G 19
	NEW E 280 T CDI (211.220)	2987	140	03.2005	07.2009	OM 642.920 not for SA code U43, U83	6	GPE 83
	NEW E 280 T CDI 4-matic (211.284)	2987	140	03.2005	07.2009	OM 642.921 not for SA code U43, U83	6	GPE 83
	E 320 T CDI (211.226)	3222	150	03.2003	07.2009	OM 648.961 not for SA code 494	6	G 19
	NEW E 320 T CDI (211.222)	2987	165	03.2005	07.2009	OM 642.920 not for SA code U43, U83	6	GPE 83
	NEW E 320 T CDI 4-matic (211.289)	2987	165	03.2005	07.2009	OM 642.920 not for SA code U43, U83	6	GPE 83
G-CLASS (W460)	240 GD (460,3)	2399	53	03.1979	08.1987	OM 616.936	4	G 41
	250 GD (460,3)	2497	62	10.1987	01.1989	OM 602.930	5	G 41
	250 GD (460,3)	2497	62	02.1989	12.1992	OM 602.930	5	G 24
	250 GD (460,3)	2497	68	12.1988	01.1989	OM 602.930	5	G 41
	250 GD (460,3)	2497	68	02.1989	08.1992	OM 602.930	5	G 24
	300 GD (460,3)	2998	65	08.1980	01.1989	OM 617.931	5	G 41
	300 GD (460,3)	2998	65	02.1989	12.1991	OM 617.931	5	G 24
	300 GD (460,3)	2996	83	09.1989	07.1993	OM 603.912	6	G 24
G-CLASS (W461)	250 GD (461)	2497	68	02.1990	05.1993	OM 602.939	5	G 24
	G 270 CDI	2685	115	01.2003		OM 612.966	5	G 19
	290 GD/G 290 D (461.337, 461.338)	2874	70	04.1992	07.2000	OM 602.942	5	G 24
	G 290 TD (461.335, 461.336)	2874	88	07.1997		OM 602.983	5	G 53
	NEW G 280 CDI (461.304-346-370-334-339)	2987	135	04.2009	06.2012	OM 642.884/OM 642.975	6	GPE 83
	NEW G 300 CDI	2987	135	04.2010	06.2012	OM 642.884 engine ->41330713	6	GPE 83
G-CLASS (W463)	250 GD (463.324, 463.325)	2497	69	06.1990	10.1992	OM 602.931	5	G 24
	G 270 CDI (463.322, 463.323)	2685	115	10.2001		OM 612.965	5	G 19
	300 GD (463.327, 463.328)	2996	83	09.1989	06.1993	OM 603.931	6	G 24
	G 300 TD (463.330, 463.331)	2996	130	08.1996	07.2000	OM 606.964	6	G 61
	350 G Turbo D (463.320, 463.321)	3449	100	09.1991	06.1993	OM 603.972	6	G 24
	G 400 CDI (463.332, 463.333)	3996	184	12.2000		OM 628.962	8	G 19
G-CLASS Cabrio (W463)	300 GD (463.307)	2996	83	12.1990	09.1997	OM 603.931	6	G 24
	G 300 TD (463.308)	2996	130	09.1996	07.2000	OM 606.964	6	G 61
	350 G Turbo-D (463.300)	3449	100	09.1991	09.1997	OM 603.972	6	G 24
	G 400 CDI (463.309)	3996	184	12.2000		OM 628.962	8	G 19
GL-CLASS (X164)	NEW GL 320 CDI 4-matic (164.822)	2987	165	09.2006	05.2009	OM 642.940	6	GPE 83
	NEW GL 350 CDI 4-matic (164.822)	2987	165	05.2009	08.2013	OM 642.940	6	GPE 83
	NEW GL 420 CDI 4-matic (164.828)	3996	225	09.2006	05.2009	OM 629.912	8	GPE 83
	NEW GL 450 CDI 4-matic (164.828)	3996	225	05.2009		OM 629.912	8	GPE 83
GLA-CLASS (X156)	NEW GLA 180 CDI / d (156.912)	1461	80	07.2014		OM 607.951	4	GPE 78
GLK-CLASS (X204)	NEW 320 CDI 4-matic (204.983)	2987	165	06.2008	08.2013	OM 642.961	6	GPE 83
KOMBI Kombi (S123)	240 T D (123.183)	2399	53	08.1980	12.1985	OM 616.912	4	G 41
	300 T D (123.190)	2998	59	08.1980	10.1985	OM 617.912	5	G 41
	300 T D (123.190)	2998	65	08.1980	11.1985	OM 617.912	5	G 41
	300 T Turbo-D (123.193)	2998	92	10.1980	11.1985	OM 617.952	5	G 41
KOMBI Kombi (S124)	200 T D (124.180)	1997	53	09.1985	01.1989	OM 601.912	4	G 41
	200 T D (124.180)	1997	53	02.1989	08.1991	OM 601.912	4	G 24
	200 T D (124.180)	1997	55	09.1988	01.1989	OM 601.912	4	G 41
	200 T D (124.180)	1997	55	02.1989	08.1991	OM 601.912	4	G 24
	250 T D (124.185)	2497	66	09.1985	01.1989	OM 602.912	5	G 41
	250 T D (124.185)	2497	66	02.1989	06.1993	OM 602.912	5	G 24
	250 T D (124.185)	2497	69	01.1989	06.1993	OM 602.912	5	G 24
	300 T D (124.190)	2996	80	09.1986	01.1989	OM 603.912	6	G 41
	300 T D (124.190)	2996	80	02.1989	06.1993	OM 603.912	6	G 24
	250 TD Turbo (124.128)	2497	93	03.1988	01.1989	OM 602.962	5	G 41
	250 TD Turbo (124.128)	2497	93	02.1989	07.1993	OM 602.962	5	G 24
	300 T D (124.190)	2996	81	01.1989	06.1993	OM 603.912	6	G 24
	300 T D (124.190)	2996	83	02.1989	06.1993	OM 603.912	6	G 24
	300 T Turbo-D	2996	105	09.1986	01.1989	OM 603.960/OM 603.963	6	G 41
	300 T Turbo-D (124.193)	2996	108	02.1989	06.1993	OM 603.960	6	G 24
	300 T Turbo-D 4-matic (124.393)	2996	108	02.1989	06.1993	OM 603.960	6	G 24



**kw****Cyl.****MERCEDES**

M-CLASS (W163)	ML 270 CDI (163.113)	2685	120	12.1999	06.2005	OM 612.963	5	G 19	
	ML 400 CDI (163.128)	3996	184	09.2001	06.2005	OM 628.963	8	G 19	
M-CLASS (W164)	NEW ML 280 CDI 4-matic (164.120)	2987	140	07.2005	07.2009	OM 642.940	6	GPE 83	
	NEW ML 300 CDI 4-matic (164.120)	2987	140	07.2009	12.2011	OM 642.940	6	GPE 83	
	NEW ML 320 CDI 4-matic (164.122)	2987	165	07.2005	07.2009	OM 642.940	6	GPE 83	
	NEW ML 350 CDI 4-matic (164.122)	2987	165	07.2009	12.2011	OM 642.940	6	GPE 83	
	NEW ML 420 CDI 4-matic (164.128)	3996	225	02.2006	09.2009	OM 629.912	8	GPE 83	
	NEW ML 450 CDI 4-matic (164.128)	3996	225	09.2009	12.2011	OM 629.912	8	GPE 83	
R-CLASS (W251, V251)	NEW R 280 CDI (251.121, 251.026, 251.126)	2987	140	05.2006	08.2013	OM 642.950	6	GPE 83	
	NEW R 280 CDI 4-matic (251.020)	2987	140	05.2006	08.2013	OM 642.950	6	GPE 83	
	NEW R 300 CDI 4-matic (251.020)	2987	140	07.2009	08.2013	OM 642.950	6	GPE 83	
	NEW R 300 CDI 4-matic (251.021, 121.026, 126)	2987	140	07.2009	08.2013	OM 642.950	6	GPE 83	
	NEW R 320 CDI 4-matic (251.125)	2987	155	06.2007	05.2009	OM 642.950	6	GPE 83	
	NEW R 320 CDI 4-matic (251.022, 251.122)	2987	165	01.2006	08.2013	OM 642.950	6	GPE 83	
	NEW R 350 CDI 4-matic (251.022, 251.122)	2987	165	07.2009	08.2013	OM 642.950	6	GPE 83	
	S-CLASS (W140)	S 300 Turbo-D (140.135)	2996	130	05.1996	10.1998	OM 606.961	6	G 61
	S 350 Turbo-D (140.134)	3449	110	01.1993	10.1998	OM 603.971	6	G 24	
S-CLASS (W220)	S 320 CDI (220.026, 220.126)	3222	145	08.1999	09.2002	OM 613.960	6	G 19	
	S 320 CDI (220.025, 220.125)	3222	150	09.2002	08.2005	OM 648.960	6	G 19	
	S 400 CDI (220.028, 220.128)	3996	184	06.2000	08.2005	OM 628.960	8	G 19	
	S 400 CDI (220.028, 220.128)	3996	191	06.2003	08.2005	OM 628.960	8	G 19	
S-CLASS (W221)	S 320 CDI 4-matic (221.080, 221.180)	2987	155	10.2005	08.2013	OM 642.932	6	GPE 83	
	NEW S 320 CDI (221.022, 221.122)	2987	173	12.2005	06.2009	OM 642.930	6	GPE 83	
	NEW S 320 CDI 4-matic (221.080, 221.180)	2987	173	10.2006	08.2013	OM 642.932	6	GPE 83	
	NEW S 420 CDI / S 450 CDI (221.028, 221.128)	3996	235	10.2006	08.2013	OM 629.911	8	GPE 83	
SPRINTER 2-t Bus (901, 902)	208 CDI	2148	60	04.2000	05.2006	OM 611.987	4	G 19	
	208 D	2299	58	02.1995	04.2000	OM 601.943	4	G 24	
	210 D	2874	75	03.1997	04.2000	OM 602.980	5	G 53	
	211 CDI	2148	80	04.2000	05.2006	OM 611.981	4	G 19	
	212 D	2874	90	02.1995	04.2000	OM 602.980 engine n°-> 9849	5	G 41	
	212 D	2874	90	02.1995	04.2000	OM 602.980 engine n°-> 0136	5	G 41	
	212 D	2874	90	02.1995	04.2000	OM 602.980 engine n°9850 ->	5	G 53	
	212 D	2874	90	02.1995	04.2000	OM 602.980 engine n°0137 ->	5	G 53	
	213 CDI	2148	95	04.2000	05.2006	OM 611.981	4	G 19	
	216 CDI	2685	115	04.2000	05.2006	OM 612.981	5	G 19	
	SPRINTER 2-t Camionnette (901, 902)	208 CDI	2148	60	04.2000	05.2006	OM 611.987	4	G 19
		208 D	2299	58	02.1995	04.2000	OM 601.943	4	G 24
208 D		2299	60	10.1996	04.2000	OM 601.943	4	G 24	
210 D		2874	75	01.1997	04.2000	OM 602.980	5	G 53	
211 CDI		2148	80	04.2000	05.2006	OM 611.981	4	G 19	
212 D		2874	90	02.1995	04.2000	OM 602.980 engine n°-> 9849	5	G 41	
212 D		2874	90	02.1995	04.2000	OM 602.980 engine n°-> 0136	5	G 41	
212 D		2874	90	02.1995	04.2000	OM 602.980 engine n°9850 ->	5	G 53	
212 D		2874	90	02.1995	04.2000	OM 602.980 engine n°0137 ->	5	G 53	
213 CDI		2148	95	04.2000	05.2006	OM 611.981	4	G 19	
216 CDI		2685	115	04.2000	05.2006	OM 612.981	5	G 19	
SPRINTER 2-t Camion/ Plate-forme (901, 902)		208 CDI	2148	60	04.2000	05.2006	OM 611.987	4	G 19
	208 D	2299	58	01.1995	04.2000	OM 601.943	4	G 24	
	208 D	2299	60	09.1996	04.2000	OM 601.943	4	G 24	
	210 D	2874	75	01.1997	04.2000	OM 602.980	5	G 53	
	211 CDI	2148	80	04.2000	05.2006	OM 611.981	4	G 19	
	212 D	2874	90	02.1995	04.2000	OM 602.980 engine n°-> 9849	5	G 41	
	212 D	2874	90	02.1995	04.2000	OM 602.980 engine n°-> 0136	5	G 41	
	212 D	2874	90	02.1995	04.2000	OM 602.980 engine n°9850 ->	5	G 53	
	212 D	2874	90	02.1995	04.2000	OM 602.980 engine n°0137 ->	5	G 53	
	213 CDI	2148	95	04.2000	05.2006	OM 611.981	4	G 19	
	216 CDI	2685	115	04.2000	05.2006	OM 612.981	5	G 19	

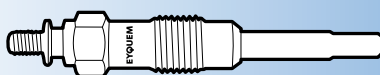



kW



Cyl.

**MERCEDES**

SPRINTER 3-t Bus (903)	308 CDI	2148	60	04.2000	05.2006	OM 611.987	4	G 19	
	308 D	2299	58	02.1995	04.2000	OM 601.943	4	G 24	
	308 D (903.371, 903.372, 903.373)	2299	60	03.1997	04.2000	OM 601.943	4	G 24	
	310 D 4x4	2874	75	05.1997	08.2002	OM 602.980	5	G 53	
	311 CDI	2148	80	04.2000	05.2006	OM 611.981	4	G 19	
	311 CDI 4x4	2148	80	08.2002	05.2006	OM 611.981	4	G 19	
	312 D 2.9	2874	90	02.1995	04.2000	OM 602.980 engine n°-> 9849	5	G 41	
	312 D 2.9	2874	90	02.1995	04.2000	OM 602.980 engine n°-> 0136	5	G 41	
	312 D 2.9	2874	90	02.1995	04.2000	OM 602.980 engine n°9850 ->	5	G 53	
	312 D 2.9	2874	90	02.1995	04.2000	OM 602.980 engine n°0137 ->	5	G 53	
	312 D 2.9 4x4	2874	90	05.1997	08.2002	OM 602.980 engine n°-> 9849	5	G 41	
	312 D 2.9 4x4	2874	90	05.1997	08.2002	OM 602.980 engine n°-> 0136	5	G 41	
	312 D 2.9 4x4	2874	90	05.1997	08.2002	OM 602.980 engine n°9850 ->	5	G 53	
	312 D 2.9 4x4	2874	90	05.1997	08.2002	OM 602.980 engine n°0137 ->	5	G 53	
	313 CDI	2148	95	04.2000	05.2006	OM 611.981	4	G 19	
	313 CDI 4x4	2148	95	08.2002	05.2006	OM 611.981	4	G 19	
	316 CDI	2685	115	04.2000	05.2006	OM 612.981	5	G 19	
	316 CDI 4x4	2685	115	08.2002	05.2006	OM 612.981	5	G 19	
	SPRINTER 3-t Bus (906)	211 CDI (906.711, 906.713)	2148	80	06.2006	12.2009	OM 646.985	4	G 19
		215 CDI (906.711, 906.713)	2148	110	06.2006	12.2009	OM 646.990	4	G 19
SPRINTER 3-t Camionnette (903)	308 CDI	2148	60	04.2000	05.2006	OM 611.987	4	G 19	
	308 D 2.3	2299	58	02.1995	04.2000	OM 601.943	4	G 24	
	308 D 2.3	2299	60	02.1995	04.2000	OM 601.943	4	G 24	
	310 D 2.9	2874	75	01.1997	04.2000	OM 602.980	5	G 53	
	311 CDI	2148	80	04.2000	05.2006	OM 611.981	4	G 19	
	311 CDI 4x4	2148	80	08.2002	05.2006	OM 611.981	4	G 19	
	312 D 2.9	2874	90	02.1995	04.2000	OM 602.980 engine n°-> 9849	5	G 41	
	312 D 2.9	2874	90	02.1995	04.2000	OM 602.980 engine n°-> 0136	5	G 41	
	312 D 2.9	2874	90	02.1995	04.2000	OM 602.980 engine n°9850 ->	5	G 53	
	312 D 2.9	2874	90	02.1995	04.2000	OM 602.980 engine n°0137 ->	5	G 53	
	312 D 2.9 4x4	2874	90	05.1997	08.2002	OM 602.980 engine n°-> 9849	5	G 41	
	312 D 2.9 4x4	2874	90	05.1997	08.2002	OM 602.980 engine n°-> 0136	5	G 41	
	312 D 2.9 4x4	2874	90	05.1997	08.2002	OM 602.980 engine n°9850 ->	5	G 53	
	312 D 2.9 4x4	2874	90	05.1997	08.2002	OM 602.980 engine n°0137 ->	5	G 53	
	313 CDI	2148	95	04.2000	05.2006	OM 611.981	4	G 19	
	313 CDI 4x4	2148	95	08.2002	05.2006	OM 611.981	4	G 19	
	316 CDI	2685	115	04.2000	05.2006	OM 612.981	5	G 19	
	316 CDI 4x4	2685	115	08.2002	05.2006	OM 612.981	5	G 19	
		209 CDI	2148	65	06.2006		OM 646.984	4	G 19
		211 CDI	2148	80	06.2006		OM 646.985	4	G 19
	213 CDI	2148	95	06.2006		OM 646.986	4	G 19	
	215 CDI	2148	110	06.2006		OM 646.990	4	G 19	
SPRINTER 3-t Camionnette (906)	209 CDI (906.611, 906.613)	2148	65	06.2006	12.2009	OM 646.984	4	G 19	
	211 CDI (906.611, 906.613)	2148	80	06.2006	12.2009	OM 646.985	4	G 19	
	213 CDI (906.611, 906.613)	2148	95	06.2006	12.2009	OM 646.986	4	G 19	
	215 CDI (906.611, 906.613)	2148	110	06.2006	12.2009	OM 646.990, OM 646.989	4	G 19	
	NEW 218 CDI (906.611, 906.613)	2987	135	06.2006	12.2009	OM 642.896; OM 642.992	6	GPE 83	
	NEW 219 CDI / BlueTEC (906.611, 906.613)	2987	140	03.2009		OM 642.896; OM 642.992	6	GPE 83	
SPRINTER 3-t Camion/ Plate-forme (903)	308 CDI	2148	60	04.2000	05.2006	OM 611.987	4	G 19	
	308 D 2.3	2299	58	02.1995	04.2000	OM 601.943	4	G 24	
	308 D 2.3	2299	60	11.1996	04.2000	OM 601.943	4	G 24	
	310 D 2.9	2874	75	01.1997	04.2000	OM 602.980	5	G 53	
	311 CDI	2148	80	04.2000	05.2006	OM 611.981	4	G 19	
	311 CDI 4x4	2148	80	08.2002	05.2006	OM 611.981	4	G 19	
	312 D 2.9 (903.411, 412, 413, 421, 422,...)	2874	85	12.1998	09.2001	OM 602.980 engine n°-> 9849	5	G 41	
	312 D 2.9 (903.411, 412, 413, 421, 422,...)	2874	85	12.1998	09.2001	OM 602.980 engine n°-> 0136	5	G 41	
	312 D 2.9 (903.411, 412, 413, 421, 422,...)	2874	85	12.1998	09.2001	OM 602.980 engine n°9850 ->	5	G 53	
	312 D 2.9 (903.411, 412, 413, 421, 422,...)	2874	85	12.1998	09.2001	OM 602.980 engine n°0137 ->	5	G 53	
	312 D 2.9	2874	90	02.1995	04.2000	OM 602.980 engine n°-> 9849	5	G 41	





kW



Cyl.



MERCEDES

	312 D 2.9	2874	90	02.1995	04.2000	OM 602.980 engine n°-> 0136	5	G 41
	312 D 2.9	2874	90	02.1995	04.2000	OM 602.980 engine n°9850 ->	5	G 53
	312 D 2.9	2874	90	02.1995	04.2000	OM 602.980 engine n°0137 ->	5	G 53
	313 CDI	2148	95	04.2000	05.2006	OM 611.981	4	G 19
	313 CDI 4x4	2148	95	08.2002	05.2006	OM 611.981	4	G 19
	316 CDI	2685	115	04.2000	05.2006	OM 612.981	5	G 19
	316 CDI 4x4	2685	115	08.2002	05.2006	OM 612.981	5	G 19
SPRINTER 3-t Camion/ Plate-forme (906)	209 CDI (906.111, 113, 211, 213)	2148	65	06.2006	12.2009	OM 646.984	4	G 19
	211 CDI (906.113, 906.211, 213)	2148	80	06.2006	12.2009	OM 646.985	4	G 19
	213 CDI (906.113, 906.211, 213)	2148	95	06.2006	12.2009	OM 646.986	4	G 19
	215 CDI (906.111, 113, 211, 213)	2148	110	06.2006	12.2009	OM 646.990	4	G 19
NEW	218 CDI (906.111, 906.113, 906.211, 906.213)	2987	135	06.2006		OM 642.896 engine n°->41330713	6	GPE 83
NEW	218 CDI (906.111, 906.113, 906.211, 906.213)	2987	135	06.2006		OM 642.992; OM 642.993	6	GPE 83
NEW	219 CDI / BlueTEC (906.111, 906.113, 906.211, 906.213)	2987	140	03.2009	06.2012	OM 642.896 engine n°->41330713	6	GPE 83
NEW	219 CDI / BlueTEC (906.111, 906.113, 906.211, 906.213)	2987	140	03.2009	08.2013	OM 642.993	6	GPE 83
SPRINTER 3,5-t Bus (906)	311 CDI (906.731, 906.733, 906.735)	2148	80	06.2006	12.2009	OM 646.985	4	G 19
	311 CDI 4x4 (906.733, 906.733, 735)	2148	80	02.2008		OM 646.985	4	G 19
	315 CDI (906.731, 906.733, 906.735)	2148	110	06.2006	12.2009	OM 646.990; OM 646.989	4	G 19
	315 CDI 4x4 (906.733, 906.733, 735)	2148	110	02.2008	12.2009	OM 646.990; OM 646.989	4	G 19
NEW	318 CDI, 4x4 (906.731, 906.733, 735)	2987	135	02.2008		OM 642.896 engine n°->41330713	6	GPE 83
NEW	318 CDI, 4x4 (906.731, 906.733, 735)	2987	135	02.2008		OM 642.992; OM 642.993	6	GPE 83
NEW	319 CDI / BlueTEC, 4x4 (906.731, 906.733, 735)	2987	140	03.2009	06.2012	OM 642.896 engine n°->41330713	6	GPE 83
NEW	319 CDI / BlueTEC, 4x4 (906.731, 906.733, 735)	2987	140	03.2009	08.2013	OM 642.992	6	GPE 83
SPRINTER 3,5-t Camionnette (906)	NEW 318 CDI (906.631, 906.633, 906.635, 906.637)	2987	135	06.2006		OM 642.896; OM 642.992; OM 642.993	6	GPE 83
	NEW 319 CDI / BlueTEC (906.631, 906.633, 906.635, 906.637)	2987	140	03.2009		OM 642.896; OM 642.898; OM 642.992	6	GPE 83
	NEW 318 CDI 4x4 (906.631, 906.633, 906.635, 906.637)	2987	135	02.2008		OM 642.896; OM 642.992; OM 642.993	6	GPE 83
	NEW 319 CDI / BlueTEC 4x4 (906.631, 906.633, 906.635, 906.637)	2987	140	03.2009		OM 642.896; OM 642.898; OM 642.992	6	GPE 83
	309 CDI (906.631, 633, 635, 637)	2148	65	06.2006	12.2009	OM 646.984	4	G 19
	311 CDI (906.631, 633, 635, 637)	2148	80	06.2006	12.2009	OM 646.985	4	G 19
	311 CDI 4x4 (906.633, 635, 637)	2148	80	02.2008	12.2009	OM 646.985	4	G 19
	313 CDI (906.631, 633, 635, 637)	2148	95	06.2006		OM 646.986	4	G 19
	315 CDI (906.631, 633, 635, 637)	2148	110	06.2006	12.2009	OM 646.990	4	G 19
	315 CDI 4x4 (906.633, 906.635, 637)	2148	110	02.2008	12.2009	OM 646.990	4	G 19
	NEW 318 CDI (906.631, 633, 635, 637)	2987	135	06.2006	12.2009	OM 642.896 engine n°->41330713	6	GPE 83
	NEW 318 CDI 4x4 (906.631, 633, 635, 637)	2987	140	02.2008	12.2009	OM 642.896 engine n°->41330713	6	GPE 83
	NEW 318 CDI 4x4 (906.631, 633, 635, 637)	2987	140	02.2008	12.2009	OM 642.992; OM 642.993	6	GPE 83
	NEW 319 CDI / BlueTEC, 4x4 (906.631, 633, 635)	2987	140	03.2009	06.2012	OM 642.896, 898 engine n°->41330713	6	GPE 83
	NEW 319 CDI / BlueTEC, 4x4 (906.631, 633, 635)	2987	140	03.2009	08.2013	OM 642.992	6	GPE 83
SPRINTER 3,5 Camion/ Plate-forme (906)	309 CDI (906.131, 133, 135, 231, 233,...)	2148	65	06.2006	12.2009	OM 646.984	4	G 19
	311 CDI (906.131, 133, 135, 231, 233,...)	2148	80	06.2006	12.2009	OM 646.985	4	G 19
	311 CDI 4x4 (906.133, 135, 231, 233,...)	2148	80	02.2008	12.2009	OM 646.985	4	G 19
	313 CDI (906.131, 133, 135, 231, 233,...)	2148	95	06.2006		OM 646.986	4	G 19
	315 CDI (906.131, 133, 135, 231, 233,...)	2148	110	06.2006	12.2009	OM 646.990	4	G 19
	315 CDI 4x4 (906.133, 906.135, 906.233, 906.235)	2148	110	02.2008	12.2009	OM 646.990	4	G 19





kW



Cyl.



MERCEDES

	NEW 318 CDI (906.131, 906.133, 906.135, 906.231, 906.233...)	2987	135	06.2006		OM 642.896 engine n°->41330713	6	GPE 83
	NEW 318 CDI (906.131, 906.133, 906.135, 906.231, 906.233...)	2987	135	06.2006	12.2009	OM 642.992; OM 642.993	6	GPE 83
	NEW 318 CDI 4x4 (906.131, 906.133, 906.135, 906.231...)	2987	135	02.2008	12.2009	OM 642.896 engine n°->41330713	6	GPE 83
	NEW 318 CDI 4x4 (906.131, 906.133, 906.135, 906.231...)	2987	135	02.2008		OM 642.992; OM 642.993	6	GPE 83
	NEW 319 CDI / BlueTEC (906.131, 906.133, 906.135, 906.231...)	2987	140	03.2009	06.2012	OM 642.896 engine n°->41330713	6	GPE 83
	NEW 319 CDI / BlueTEC (906.131, 906.133, 906.135, 906.231...)	2987	140	03.2009	08.2013	OM 642.992; OM 642.993	6	GPE 83
	NEW 319 CDI / BlueTEC 4x4 (906.131, 906.133, 906.135, 906.231...)	2987	140	05.2011	06.2012	OM 642.896 engine n°->41330713	6	GPE 83
	NEW 319 CDI / BlueTEC 4x4 (906.131, 906.133, 906.135, 906.231...)	2987	140	05.2011	08.2013	OM 642.992; OM 642.993	6	GPE 83
SPRINTER 4-t Bus (904)	408 CDI	2148	60	04.2000	05.2006	OM 611.987	4	G 19
	411 CDI	2148	80	04.2000	05.2006	OM 611.981	4	G 19
	413 CDI	2148	95	04.2000	05.2006	OM 611.981	4	G 19
	416 CDI	2685	115	04.2000	05.2006	OM 612.981	5	G 19
SPRINTER 4-t Camionnette (904)	408 CDI	2148	60	04.2000	05.2006	OM 611.987	4	G 19
	408 D	2299	58	02.1996	05.2006	OM 601.943	4	G 24
	411 CDI	2148	80	04.2000	05.2006	OM 611.981	4	G 19
	411 CDI 4x4	2148	80	04.2000	05.2006	OM 611.981	4	G 19
	413 CDI	2148	95	04.2000	05.2006	OM 611.981	4	G 19
	413 CDI 4x4	2148	95	04.2000	05.2006	OM 611.981	4	G 19
	416 CDI	2685	115	04.2000	05.2006	OM 612.981	5	G 19
	416 CDI 4x4	2685	115	04.2000	05.2006	OM 612.981	5	G 19
	410 D, 4x4	2874	75	02.1996	03.2000	OM 602.980 engine n°-> 9849	5	G 41
	410 D, 4x4	2874	75	02.1996	03.2000	OM 602.980 engine n°-> 0136	5	G 41
	410 D, 4x4	2874	75	02.1996	03.2000	OM 602.980 engine n°9850 ->	5	G 53
	410 D, 4x4	2874	75	02.1996	03.2000	OM 602.980 engine n°0137 ->	5	G 53
	412 D	2874	85	02.1996	03.2000	OM 602.980 engine n°-> 9849	5	G 41
	412 D	2874	85	02.1996	03.2000	OM 602.980 engine n°-> 0136	5	G 41
	412 D	2874	85	02.1996	03.2000	OM 602.980 engine n°9850 ->	5	G 53
	412 D	2874	85	02.1996	03.2000	OM 602.980 engine n°0137 ->	5	G 53
	412 D 4x4	2874	85	05.1997	03.2000	OM 602.980 engine n°-> 9849	5	G 41
	412 D 4x4	2874	85	05.1997	03.2000	OM 602.980 engine n°-> 0136	5	G 41
	412 D 4x4	2874	85	05.1997	03.2000	OM 602.980 engine n°9850 ->	5	G 53
	412 D 4x4	2874	85	05.1997	03.2000	OM 602.980 engine n°0137 ->	5	G 53
412 D	2874	90	02.1996	03.2000	OM 602.980 engine n°-> 9849	5	G 41	
412 D	2874	90	02.1996	03.2000	OM 602.980 engine n°-> 0136	5	G 41	
412 D	2874	90	02.1996	03.2000	OM 602.980 engine n°9850 ->	5	G 53	
412 D	2874	90	02.1996	03.2000	OM 602.980 engine n°0137 ->	5	G 53	
412 D 4x4	2874	90	05.1997	03.2000	OM 602.980 engine n°-> 9849	5	G 41	
412 D 4x4	2874	90	05.1997	03.2000	OM 602.980 engine n°-> 0136	5	G 41	
412 D 4x4	2874	90	05.1997	03.2000	OM 602.980 engine n°9850 ->	5	G 53	
412 D 4x4	2874	90	05.1997	03.2000	OM 602.980 engine n°0137 ->	5	G 53	
SPRINTER 4-t Camion/ Plate-forme (904)	408 CDI	2148	60	04.2000	05.2006	OM 611.987	4	G 19
	411 CDI, 4x4	2148	80	04.2000	05.2006	OM 611.981	4	G 19
	413 CDI, 4x4	2148	95	04.2000	05.2006	OM 611.981	4	G 19
	416 CDI, 4x4	2685	115	04.2000	05.2006	OM 612.981	5	G 19
	408 D	2299	58	02.1996	05.2006	OM 601.943	4	G 24
	410 D, 4x4	2874	75	02.1996	03.2000	OM 602.980 engine n°-> 9849	5	G 41
	410 D, 4x4	2874	75	02.1996	03.2000	OM 602.980 engine n°-> 0136	5	G 41
	410 D, 4x4	2874	75	02.1996	05.2006	OM 602.980 engine n°9850 ->	5	G 53
	410 D, 4x4	2874	75	02.1996	05.2006	OM 602.980 engine n°0137 ->	5	G 53
	412 D, 4x4	2874	85	02.1996	03.2000	OM 602.980 engine n°-> 9849	5	G 41
	412 D, 4x4	2874	85	02.1996	03.2000	OM 602.980 engine n°-> 0136	5	G 41
	412 D, 4x4	2874	85	02.1996	03.2000	OM 602.980 engine n°9850 ->	5	G 53
	412 D, 4x4	2874	85	02.1996	03.2000	OM 602.980 engine n°0137 ->	5	G 53
	412 D	2874	90	02.1996	03.2000	OM 602.980 engine n°-> 9849	5	G 41
	412 D	2874	90	02.1996	03.2000	OM 602.980 engine n°-> 0136	5	G 41
	412 D	2874	90	02.1996	03.2000	OM 602.980 engine n°9850 ->	5	G 53

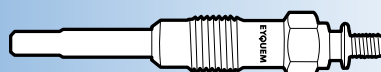



kW



Cyl.



MERCEDES

	412 D	2874	90	02.1996	03.2000	OM 602.980 engine n°0137 ->	5	G 53
SPRINTER 4,6-t Camionnette (906)	411 CDI (906.653, 906.655, 906.657)	2148	80	06.2009	12.2009	OM 646.985	4	G 19
	413 CDI (906.653, 906.655, 906.657)	2148	95	06.2009	12.2009	OM 646.986	4	G 19
	415 CDI (906.653, 906.655, 906.657)	2148	110	06.2009	12.2009	OM 646.990, OM 646.989	4	G 19
	NEW 418 CDI (906.653, 906.655, 906.657)	2987	135	06.2009	06.2012	OM 642.896 engine n°->41330713	6	GPE 83
	NEW 418 CDI (906.653, 906.655, 906.657)	2987	135	06.2009	08.2013	OM 642.992	6	GPE 83
	NEW 419 CDI (906.653, 906.655, 906.657)	2987	140	03.2009	08.2013	OM 642.992	6	GPE 83
SPRINTER 4,6-t Camion/ Plate-forme (906)	411 CDI (906.153, 906.155, 906.253, 255)	2148	80	06.2009	12.2009	OM 646.985	4	G 19
	413 CDI (906.153, 906.155, 906.253, 255)	2148	95	06.2006		OM 646.986	4	G 19
	415 CDI (906.153, 906.155, 906.253, 255)	2148	110	06.2009	12.2009	OM 646.990, OM 646.989	4	G 19
	NEW 418 CDI (906.153, 906.155, 906.253, 906.255)	2987	135	06.2006	12.2009	OM 642.896 engine n°->41330713	6	GPE 83
	NEW 418 CDI (906.153, 906.155, 906.253, 906.255)	2987	135	06.2006	12.2009	OM 642.992; OM 642.993	6	GPE 83
	NEW 419 CDI (906.153, 906.155, 906.253, 906.255)	2987	140	03.2009	06.2012	OM 642.896 engine n°->41330713	6	GPE 83
	NEW 419 CDI (906.153, 906.155, 906.253, 906.255)	2987	140	03.2009	08.2013	OM 642.992	6	GPE 83
SPRINTER 5-t Camionnette (906)	509 CDI (906.653, 905.655, 906.657)	2148	65	06.2006	12.2009	OM 646.984	4	G 19
	511 CDI, 4x4 (906.653, 905.655, 906.657)	2148	80	06.2006	12.2009	OM 646.985	4	G 19
	513 CDI (906.653, 905.655, 906.657)	2148	95	06.2006		OM 646.986	4	G 19
	515 CDI, 4x4 (906.653, 905.655, 906.657)	2148	110	06.2006	12.2009	OM 646.986	4	G 19
	NEW 518 CDI (906.653, 906.655, 906.657)	2987	135	06.2006	12.2009	OM 642.896 engine n°->41330713	6	GPE 83
	NEW 518 CDI (906.653, 906.655, 906.657)	2987	135	06.2006	12.2009	OM 642.992; OM 642.993	6	GPE 83
	NEW 518 CDI, 4x4 (906.653, 906.655, 906.657)	2987	135	06.2006	12.2009	OM 642.896 engine n°->41330713	6	GPE 83
	NEW 518 CDI, 4x4 (906.653, 906.655, 906.657)	2987	135	06.2006	12.2009	OM 642.992; OM 642.993	6	GPE 83
	NEW 519 CDI, 4x4 (906.653, 906.655, 906.657)	2987	140	03.2009	06.2012	OM 642.896; OM 642.898	6	GPE 83
	NEW 519 CDI, 4x4 (906.653, 906.655, 906.657)	2987	140	03.2009	08.2013	OM 642.992	6	GPE 83
SPRINTER 5-t Camion/Plate-forme	616 CDI (905.612, 905.613, 905.622, 905.623)	2685	115	04.2001	05.2006	OM 612.981	5	G 19
SPRINTER 5-t Camion/ Plate-forme (906)	509 CDI (906.153, 155, 253, 255)	2148	65	06.2006	12.2009	OM 646.984	4	G 19
	511 CDI, 4x4 (906.153, 155, 253, 255)	2148	80	06.2006	12.2009	OM 646.985	4	G 19
	513 CDI (906.155, 905.253, 906.255)	2148	95	06.2006		OM 646.986	4	G 19
	515 CDI, 4x4 (906.153, 155, 253, 255)	2148	110	06.2006	12.2009	OM 646.990	4	G 19
	NEW 518 CDI 4x4 (906.153, 155, 253, 255)	2987	135	06.2006		OM 642.896 engine n°->41330713	6	GPE 83
	NEW 518 CDI 4x4 (906.153, 155, 253, 255)	2987	135	06.2006		OM 642.992; OM 642.993	6	GPE 83
	NEW 519 CDI / BlueTEC 4x4 (906.153, 155, 253, 255)	2987	140	03.2009	06.2012	OM 642.896, 898 engine n°->41330713	6	GPE 83
	NEW 519 CDI / BlueTEC 4x4 (906.153, 155, 253, 255)	2987	140	03.2009	08.2013	OM 642.992	6	GPE 83
SPRINTER Kipper Tricorps (W123)	616 CDI (905.612, 905.622, 905.623)	2685	115	04.2001		OM 612.981	5	G 19
	200 D	1988	44	08.1980	11.1985	OM 615.940	4	G 41
	240 D (123.123)	2399	53	08.1980	11.1985	OM 616.912	4	G 41
	300 D (123.130)	2998	65	08.1980	11.1985	OM 617.912	5	G 41
	300 Turbo-D (123.133)	2998	92	08.1981	07.1985	OM 617.952	5	G 41
Tricorps (W124)	200 D (124.120)	1997	53	12.1984	08.1989	OM 601.912	4	G 24
	200 D (124.120)	1997	53	12.1984	08.1989	OM 601.912	4	G 41
	200 D (124.120)	1997	53	12.1984	08.1989	OM 601.912	4	G 41
	200 D (124.120)	1997	53	12.1984	08.1989	OM 601.912	4	G 41
	200 D (124.120)	1997	53	12.1984	08.1989	OM 601.912	4	G 41
	200 D (124.120)	1997	53	12.1984	08.1989	OM 601.912	4	G 41
	200 D (124.120)	1997	53	12.1984	08.1989	OM 601.912	4	G 41
	200 D (124.120)	1997	53	12.1984	08.1989	OM 601.912	4	G 41
	200 D (124.120)	1997	53	12.1984	08.1989	OM 601.912	4	G 41
	250 D (124.125)	2497	66	04.1985	06.1993	OM 602.912	5	G 24
	250 D (124.125)	2497	69	01.1989	06.1993	OM 602.912	5	G 24
	250 D (124.125)	2497	66	04.1985	06.1993	OM 602.912	5	G 41
	250 D (124.125)	2497	69	01.1989	06.1993	OM 602.912	5	G 41
	250 D (124.125)	2497	66	04.1985	06.1993	OM 602.912	5	G 41
	250 D (124.125)	2497	69	01.1989	06.1993	OM 602.912	5	G 41
	250 D (124.125)	2497	66	04.1985	06.1993	OM 602.912	5	G 41
	250 D (124.125)	2497	69	01.1989	06.1993	OM 602.912	5	G 41
	250 D (124.125)	2497	66	04.1985	06.1993	OM 602.912	5	G 41
	250 D (124.125)	2497	69	01.1989	06.1993	OM 602.912	5	G 41
	250 D (124.125)	2497	66	04.1985	06.1993	OM 602.912	5	G 41
	250 D (124.125)	2497	69	01.1989	06.1993	OM 602.912	5	G 41





kW



Cyl.



MERCEDES

	250 Turbo-D (124.128)	2497	93	09.1988	06.1993	OM 602.962	5	G 24
	250 Turbo-D (124.128)	2497	93	09.1988	06.1993	OM 602.962	5	G 41
	250 Turbo-D (124.128)	2497	93	09.1988	06.1993	OM 602.962	5	G 41
	250 Turbo-D (124.128)	2497	93	09.1988	06.1993	OM 602.962	5	G 41
	250 Turbo-D (124.128)	2497	93	09.1988	06.1993	OM 602.962	5	G 41
	300 D (124.130)	2996	80	12.1984	08.1989	OM 603.912	6	G 24
	300 D (124.130)	2996	80	12.1984	08.1989	OM 603.912	6	G 41
	300 D (124.130)	2996	80	12.1984	08.1989	OM 603.912	6	G 41
	300 D (124.130)	2996	80	12.1984	08.1989	OM 603.912	6	G 41
	300 D (124.130)	2996	80	12.1984	08.1989	OM 603.912	6	G 41
	300 D (124.130)	2996	81	06.1990	06.1993	OM 603.912	6	G 24
	300 D (124.130)	2996	83	08.1989	06.1993	OM 603.912	6	G 24
	300 D 4-matic (124.330)	2996	80	09.1986	08.1992	OM 603.913	6	G 24
	300 D 4-matic (124.330)	2996	80	09.1986	08.1992	OM 603.913	6	G 41
	300 D 4-matic (124.330)	2996	80	09.1986	08.1992	OM 603.913	6	G 41
	300 D 4-matic (124.330)	2996	80	09.1986	08.1992	OM 603.913	6	G 41
	300 D 4-matic (124.330)	2996	80	09.1986	08.1992	OM 603.913	6	G 41
	300 D 4-matic (124.330)	2996	83	08.1989	06.1993	OM 603.913	6	G 24
	300 Turbo-D (124.133)	2996	108	09.1988	06.1993	OM 603.960	6	G 24
	300 Turbo-D (124.133)	2996	108	09.1988	06.1993	OM 603.960	6	G 41
	300 Turbo-D (124.133)	2996	108	09.1988	06.1993	OM 603.960	6	G 41
	300 Turbo-D (124.133)	2996	105	09.1986	09.1988	OM 603.960/OM 603.963	6	G 41
	300 Turbo-D (124.133)	2996	108	09.1988	06.1993	OM 603.960	6	G 41
	300 Turbo-D (124.133)	2996	105	09.1986	09.1988	OM 603.960/OM 603.963	6	G 41
	300 Turbo-D (124.133)	2996	108	09.1988	06.1993	OM 603.960	6	G 41
	300 Turbo-D (124.133)	2996	105	09.1986	09.1988	OM 603.960/OM 603.963	6	G 41
	300 Turbo-D 4-matic (124.333)	2996	108	01.1988	06.1993	OM 603.963	6	G 24
	300 Turbo-D 4-matic (124.333)	2996	108	01.1988	06.1993	OM 603.963	6	G 41
	300 Turbo-D 4-matic (124.333)	2996	108	01.1988	06.1993	OM 603.963	6	G 41
	300 Turbo-D 4-matic (124.333)	2996	105	09.1986	09.1988	OM 603.960/OM 603.963	6	G 41
	300 Turbo-D 4-matic (124.333)	2996	108	01.1988	06.1993	OM 603.963	6	G 41
	300 Turbo-D 4-matic (124.333)	2996	105	09.1986	09.1988	OM 603.960/OM 603.963	6	G 41
	300 Turbo-D 4-matic (124.333)	2996	108	01.1988	06.1993	OM 603.963	6	G 41
	300 Turbo-D 4-matic (124.333)	2996	105	09.1986	09.1988	OM 603.960/OM 603.963	6	G 41
T1 Bus (601)	207 D 2.4	2404	48	05.1977	12.1982	OM 616.934/OM 616.917	4	G 41
	207 D 2.4	2376	53	07.1982	09.1988	OM 616.937/OM 616.939	4	G 41
	208 D 2.3	2299	58	10.1988	02.1996	OM 601.940	4	G 24
	208 D 2.3	2299	60	10.1988	02.1996	OM 601.940	4	G 24
	209 D 2.9	2998	65	12.1982	09.1988	OM 617.913	5	G 41
	210 D 2.8	2874	70	11.1988	02.1996	OM 602.940	5	G 24
	210 D 2.8	2874	72	11.1988	02.1996	OM 602.940	5	G 24
T1 Camionnette (601, 611)	207 D 2.4	2399	53	09.1982	01.1990	OM 616.937/OM 616.939	4	G 41
	208 D 2.3	2299	58	11.1988	02.1996	OM 601.940	4	G 24
	208 D 2.3	2299	60	10.1988	02.1996	OM 601.940	4	G 24
	209 D 2.9	2998	65	12.1982	01.1990	OM 617.913	5	G 41
	210 D 2.8	2874	70	10.1988	02.1996	OM 602.940	5	G 24
	210 D 2.8	2874	72	10.1988	02.1996	OM 602.940	5	G 24
T1 Camion/Plate-forme (601)	207 D 2.4	2399	53	12.1977	10.1989	OM 616.937	4	G 41
	207 D 2.4	2404	48	04.1977	12.1982	OM 616.917	4	G 41
	208 D 2.3	2299	58	11.1988	02.1996	OM 601.940	4	G 24
	208 D 2.3	2299	60	06.1989	02.1996	OM 601.940	4	G 24
	209 D 2.9	2998	65	12.1982	01.1990	OM 617.913	5	G 41
	210 D 2.9	2874	70	11.1988	02.1996	OM 602.940	5	G 24
	210 D 2.8	2874	72	11.1988	02.1996	OM 602.940	5	G 24
T1 Bus (602)	308 D 2.3	2299	58	05.1990	02.1996	OM 601.940	4	G 24
	308 D 2.3	2299	60	06.1989	02.1996	OM 601.940	4	G 24
	310 D 2.9	2874	70	06.1989	02.1996	OM 602.940	5	G 24
	310 D 2.9	2874	72	06.1990	02.1996	OM 602.940	5	G 24
T1 Camionnette (602)	307 D 2.4	2399	53	10.1982	01.1990	OM 616.937/OM 616.939	4	G 41
	308 D 2.3	2299	58	11.1988	02.1996	OM 601.940	4	G 24
	308 D 2.3	2299	60	06.1989	02.1996	OM 601.940	4	G 24
	309 D 3.0	2998	65	10.1982	01.1990	OM 617.913	5	G 41
	310 D 2.9	2874	70	06.1989	02.1996	OM 602.940	5	G 24
	310 D 2.9	2874	72	06.1989	02.1996	OM 602.940	5	G 24
T1 Camion/Plate-forme (602)	307 D 2.4	2399	48	04.1977	01.1983	OM 616.937	4	G 41





kW



Cyl.



MERCEDES

	307 D 2.4	2399	53	06.1982	01.1990	OM 616.937/OM 616.939	4	G 41
	308 D 2.3	2299	58	06.1989	02.1996	OM 601.940	4	G 24
	308 D 2.3	2299	60	06.1989	02.1996	OM 601.940	4	G 24
	309 D 3.0	2998	65	10.1982	01.1990	OM 617.913	5	G 41
	310 D 2.9	2874	70	06.1989	02.1996	OM 602.940	5	G 24
	310 D 2.9	2874	72	06.1989	02.1996	OM 602.940	5	G 24
T1/TN Camionnette/Kombi	407 D (611.367, 611.368)	2398	53	07.1981	01.1989	OM 616.913/OM 616.939	4	G 41
	408 D (611.367, 611.368)	2299	58	11.1988	06.1995	OM 601.940	4	G 24
	408 D (611.367, 611.368)	2299	60	11.1988	06.1995	OM 601.940	4	G 24
	409 D (611.467, 611.468)	2998	65	04.1982	01.1989	OM 617.913	5	G 41
	410 D (611.467, 611.468)	2874	70	11.1988	06.1995	OM 602.940	5	G 24
	410 D (611.467, 611.468)	2874	72	11.1988	06.1995	OM 602.940	5	G 24
T1/TN Camion/Plate-forme	407 D (611.317, 611.318)	2398	53	07.1981	01.1989	OM 616.913/OM 616.939	4	G 41
	408 D (611.317, 611.318)	2299	58	11.1988	06.1995	OM 601.940	4	G 24
	408 D (611.317, 611.318)	2299	60	11.1988	06.1995	OM 601.940	4	G 24
	409 D (611.417, 611.418)	2998	65	04.1982	01.1989	OM 617.913	5	G 41
	410 D (611.417, 611.418)	2874	70	11.1988	06.1995	OM 602.940	5	G 24
	410 D (611.417, 611.418)	2874	72	11.1988	06.1995	OM 602.940	5	G 24
T2/LN1 Camionnette/Kombi	507 D (667.361, 667.362)	2399	53	04.1986	04.1989	OM 616.914	4	G 41
	508 D (667.361, 667.362)	2299	58	03.1989	12.1994	OM 601.941	4	G 24
T2/LN1 Camion/Plate-forme	507 D (667.301, 667.302, 667.341, 667.342)	2399	53	04.1986	04.1989	OM 616.914	4	G 41
T2/LN1 Kipper	507 DK (667.341, 667.342)	2399	53	04.1986	04.1989	OM 616.914	4	G 41
	508 D (667.301, 667.302, 667.341, 667.342)	2299	58	03.1989	12.1994	OM 601.941	4	G 24
T2/L Camion/Plate-forme	L 407 D (309.100, 309.101, 309.102, 103)	2404	48	09.1982	12.1988	OM 616.910	4	G 41
	L 407 D (309.100, 309.101, 309.102, 103)	2404	53	09.1982	12.1988	OM 616.910	4	G 41
T2/L Camionnette/Kombi	L 407 D (309.111, 309.112, 113, 114, 115,..)	2404	48	09.1982	12.1988	OM 616.910	4	G 41
	L 407 D (309.111, 309.112, 113, 114, 115,..)	2404	53	09.1982	12.1988	OM 616.910	4	G 41
VANEO (414)	1.7 CDI (414.700)	1689	55	02.2002	07.2005	OM 668.914	4	G 21
	1.7 CDI (414.700)	1689	67	02.2002	07.2005	OM 668.914	4	G 21
VARIO Camion/Plate-forme	512 D (667.321, 667.322, 667.323)	2874	90	09.1996	12.2010	OM 602.984	5	G 53
	612 D (668.321, 668.322, 668.323)	2874	90	09.1996	12.2010	OM 602.984/OM 602.985	5	G 53
	812 D (670.321, 670.322, 323, 324)	2874	90	09.1996	12.2010	OM 602.984/OM 602.985	5	G 53
VARIO Camionnette/Kombi	512 D (667.351, 667.352, 667.353)	2874	90	09.1996	12.2010	OM 602.984	5	G 53
	612 D (668.351, 668.352, 668.353)	2874	90	09.1996	12.2010	OM 602.984/OM 602.985	5	G 53
	812 D (670.351, 670.352, 670.353)	2874	90	09.1996	12.2010	OM 602.984/OM 602.985	5	G 53
VARIO Kipper	612 D (668.331, 668.332)	2874	90	09.1996	12.2010	OM 602.984/OM 602.985	5	G 53
	812 D (670.331, 670.332)	2874	90	09.1996	12.2010	OM 602.984/OM 602.985	5	G 53
V-CLASS (638/2)	V 200 CDI (638.294)	2151	75	03.1999	07.2003	OM 611.980	4	G 19
	V 220 CDI (638.294)	2151	90	03.1999	07.2003	OM 611.980	4	G 19
	V 230 TD (638.274)	2299	72	09.1996	07.2003	OM 601.970	4	G 24
VIANO (W639)	CDI 2.0	2148	80	09.2003		OM 646.982	4	G 19
	CDI 2.0	2148	85	08.2005		OM 646.982	4	G 19
	CDI 2.0 4-matic	2148	80	07.2005	10.2006	OM 646.982	4	G 19
	CDI 2.2	2148	110	09.2003		OM 646.980/OM 646.982	4	G 19
	CDI 2.2 4-matic	2148	110	07.2005		OM 646.982	4	G 19
	NEW CDI 3.0	2987	150	03.2006	08.2013	OM 642.990	6	GPE 83
	NEW CDI 3.0	2987	165	07.2010	08.2013	OM 642.990	6	GPE 83
VITO / MIXTO Camionnette (W447)	NEW 109 CDI (447.701, 447.703, 447.705)	1598	65	10.2014		OM 622.951	4	GPE 93
	NEW 111 CDI (447.701, 447.703, 447.705)	1598	84	10.2014		OM 622.951	4	GPE 93
VITO / MIXTO Camionnette (W639)	109 CDI	2148	65	09.2003		OM 646.983	4	G 19
	109 CDI	2148	70	08.2006		OM 646.980/OM 646.981	4	G 19
	111 CDI	2148	80	09.2003		OM 646.982	4	G 19
	111 CDI	2148	85	09.2007		OM 646.982	4	G 19
	111 CDI 4x4	2148	80	09.2007		OM 646.982	4	G 19
	115 CDI	2148	110	09.2003		OM 646.982	4	G 19
	115 CDI 4x4	2148	110	09.2007		OM 646.982	4	G 19
	NEW 120 CDI	2987	150	07.2006	08.2013	OM 642.990	6	GPE 83
VITO Bus (638)	108 CDI 2.2 (638.194)	2148	60	03.1999	07.2003	OM 611A (60 KW CDI)	4	G 19
	108 D 2.3 (638.164)	2299	58	02.1996	07.2003	OM 601.942	4	G 24

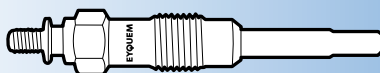



kW



Cyl.



MERCEDES

	110 CDI 2.2 (638.194)	2148	75	03.1999	07.2003	OM 611LA (75 kW CDI)	4	G 19
	110 TD 2.3 (638.174)	2299	72	02.1996	07.2003	OM 601.970	4	G 24
	112 CDI 2.2 (638.194)	2151	90	03.1999	07.2003	OM 611.980	4	G 19
VITO Bus (W639)	109 CDI	2148	65	09.2003		OM 646.983	4	G 19
	109 CDI	2148	70	09.2006		OM 646.980	4	G 19
	109 CDI 4x4	2148	70	09.2007		OM 646.981	4	G 19
	111 CDI	2148	80	09.2003		OM 646.982	4	G 19
	111 CDI (639.701)	2148	85	09.2007		OM 646.980	4	G 19
	111 CDI 4x4	2148	80	09.2007		OM 646.982	4	G 19
	115 CDI	2148	110	09.2003		OM 646.982	4	G 19
	115 CDI 4x4	2148	110	09.2007		OM 646.982	4	G 19
	NEW 120 CDI	2987	150	07.2006	08.2013	OM 642.990	6	GPE 83
VITO Camionnette (638)	108 CDI 2.2 (638.094)	2151	60	03.1999	07.2003	OM 611A (60 kW CDI)	4	G 19
	108 D 2.3 (638.064)	2299	58	03.1997	07.2003	OM 601.942	4	G 24
	110 CDI 2.2 (638.094)	2151	75	03.1999	07.2003	OM 611LA (75 kW CDI)	4	G 19
	110 D 2.3 (638.074)	2299	72	03.1997	07.2003	OM 601.970	4	G 24
	112 CDI 2.2 (638.094)	2151	90	03.1999	07.2003	OM 611.980	4	G 19
VITO Camionnette (W447)	NEW 109 CDI (447.601, 447.603, 447.605)	1598	65	10.2014		OM 622.951	4	GPE 93
	NEW 111 CDI (447.601, 447.603, 447.605)	1598	84	10.2014		OM 622.951	4	GPE 93
VITO Tourer (W447)	NEW 109 CDI / 109 BlueTEC (447.701, 447.703, 447.705)	1598	65	10.2014		OM 622.951	4	GPE 93
	NEW 111 CDI / 111 BlueTEC (447.701, 447.703, 447.705)	1598	84	10.2014		OM 622.951	4	GPE 93

MG

ZR	Turbodiesel	1994	74	06.2001		20 T2N	4	G 51
ZS	2.0 TD	1994	74	01.2004		20 T2N	4	G 51
	2.0 TD	1994	83	01.2004		20 T2N	4	G 51
ZS Hatchback	2.0 TD	1994	74	01.2004		20 T2N	4	G 51
	2.0 TD	1994	83	01.2004		20 T2N	4	G 51
ZT	2.0 CDTi	1951	85	06.2002	09.2003	204D2	4	G 23
	2.0 CDTi	1951	96	11.2002		204D2	4	G 23
ZT- T	2.0 CDTi	1951	85	06.2002	09.2003	204D2	4	G 23
	2.0 CDTi	1951	96	11.2002		204D2	4	G 23

MINI

MINI (F55)	NEW Cooper D	1496	85	10.2013		B37 C15 A	3	GPE 91	
	NEW One D	1496	70	02.2014		B37 C15 A	3	GPE 91	
MINI (F56)	NEW Cooper D	1496	85	12.2013		B37 C15 A	3	GPE 91	
	NEW One D	1496	70	07.2013		B37 C15 A	3	GPE 91	
MINI (R50, R53)	One D	1364	55	06.2003		1ND	4	G 26	
	One D	1364	65	06.2003		1ND-TV	4	G 26	
MINI (R56)	Cooper D	1560	80	03.2007		9HZ DV6TED4	4	G 72	
	NEW Cooper D	1598	82	06.2010	11.2013	N47 C16 A (OE: 12 23 7 798 001)	4	GPE 91	
	NEW Cooper D	1995	82	02.2011	11.2013	N47 C20 A (OE: 12 23 7 798 001)	4	GPE 91	
	NEW Cooper SD	1995	100	02.2011	11.2013	N47 C20 A (OE: 12 23 7 798 001)	4	GPE 91	
	NEW Cooper SD	1995	105	02.2011	11.2013	N47 C20 A (OE: 12 23 7 798 001)	4	GPE 91	
	NEW One D	1598	66	07.2010	11.2013	N47 C16 A (OE: 12 23 7 798 001)	4	GPE 91	
	MINI Cabriolet (F57)	NEW Cooper D	1496	85	12.2014		B37 C15 A	3	GPE 91
MINI Cabriolet (R57)	NEW Cooper D	1598	82	05.2009	11.2013	N47 C16 A	4	GPE 91	
	NEW Cooper D	1995	82	02.2011	05.2015	N47 C20 A	4	GPE 91	
	NEW Cooper SD	1995	105	06.2009	05.2015	N47 C20 A	4	GPE 91	
	Cooper D	1560	80	03.2007		9HZ DV6TED4	4	G 72	
MINI CLUBMAN (R55)	NEW Cooper D	1598	82	03.2010	06.2014	N47 C16 A	4	GPE 91	
	NEW Cooper D	1995	82	02.2011	06.2014	N47 C20 A	4	GPE 91	
	NEW Cooper SD	1995	100	02.2011	06.2014	N47 C20 A	4	GPE 91	
	NEW Cooper SD	1995	105	02.2011	06.2014	N47 C20 A	4	GPE 91	
	NEW One D	1598	66	03.2010	06.2014	N47 C16 A	4	GPE 91	
	MINI CLUBVAN (R55)	NEW Cooper D	1598	82	12.2012	06.2014	N47 C16 A	4	GPE 91
		NEW Cooper D	1995	82	12.2012	06.2014	N47 C20 A	4	GPE 91
MINI COUNTRYMAN (F60)	NEW One D	1496	85	07.2017		B37 C15 A	2	GPE 91	
MINI COUNTRYMAN (R60)	NEW Cooper D	1598	82	01.2010	10.2016	N47 C16 A	4	GPE 91	
	NEW Cooper D	1995	82	01.2010	10.2016	N47 C20 A	4	GPE 91	
	NEW Cooper D ALL4	1598	82	01.2010	09.2016	N47 C16 A	4	GPE 91	
	NEW Cooper D ALL4	1995	82	07.2010	09.2016	N47 C20 A	4	GPE 91	





kW



Cyl.



MINI									
	NEW	Cooper SD	1995	105	01.2010	10.2016	N47 C20 A (OE: 12 23 7 798 001)	4	GPE 91
	NEW	Cooper SD ALL4	1995	100	01.2010	10.2016	N47 C20 A (OE: 12 23 7 798 001)	4	GPE 91
	NEW	Cooper SD ALL4	1995	105	01.2010	10.2016	N47 C20 A (OE: 12 23 7 798 001)	4	GPE 91
	NEW	One D	1598	66	01.2010	10.2016	N47 C16 A	4	GPE 91
MINI Coupe (R58)	NEW	Cooper SD	1995	100	12.2010	05.2015	N47 C20 A	4	GPE 91
	NEW	Cooper SD	1995	105	12.2010	05.2015	N47 C20 A	4	GPE 91
MINI PACEMAN (R61)	NEW	Cooper D	1598	82	04.2012	09.2016	N47 C16 A	4	GPE 91
	NEW	Cooper D	1995	82	07.2012	09.2016	N47 C20 A	4	GPE 91
	NEW	Cooper D ALL4	1598	82	04.2012	09.2016	N47 C16 A	4	GPE 91
	NEW	Cooper D ALL4	1995	82	03.2012	09.2016	N47 C20 A	4	GPE 91
	NEW	Cooper SD	1995	105	03.2012	09.2016	N47 C20 A	4	GPE 91
	NEW	Cooper SD ALL4	1995	105	04.2012	09.2016	N47 C20 A	4	GPE 91
MINI ROADSTER (R59)	NEW	Cooper SD	1995	100	11.2011	04.2015	N47 C20 A	4	GPE 91
	NEW	Cooper SD	1995	105	11.2011	04.2015	N47 C20 A	4	GPE 91

MITSUBISHI									
CARISMA (DA_)		1.9 TD (DA4A)	1870	66	10.1996	09.2000	F8QT	4	G 49
CARISMA Tricorps (DA_)		1.9 TD (DA4A)	1870	66	10.1996	09.2000	F8QT	4	G 49
COLT II (C1_A)		1.8 GL Diesel (C14A)	1796	43	02.1984	09.1986	4 D 65	4	G 11
		1.8 GL Diesel (C14A)	1796	44	09.1986	04.1988	4 D 65	4	G 11
COLT III (C5_A)		1.8 Diesel GLX (C54A)	1796	44	04.1988	05.1992	4 D 65	4	G 11
GALANT II (A16_)		2.3 Turbo-D (A167)	2347	62	09.1980	05.1984	4 D 55 T	4	G 11
GALANT II Station Wagon (A16_V)		2.3 Turbo-D (A167V)	2347	62	07.1983	05.1984	4 D 55 T	4	G 11
GALANT V (E5_A, E7_A, E8_A)		2.0 GLSTD (E57A)	1998	66	11.1992	08.1996	4 D 68 T	4	G 69
GALANT V Tricorps (E5_A, E7_A, E8_A)		2.0 GLSTD (E57A)	1998	66	11.1992	08.1996	4 D 68 T	4	G 69
GALANT VI (EA_)		2.0 TDI (EA6A)	1998	66	09.1996	10.2004	4D68 SOHC	4	G 69
GALANT VI Station Wagon (EA_)		2.0 TDI (EA6W)	1998	66	09.1996	10.2003	4D68 SOHC	4	G 69
GALLOPER (JK-01)		2.5 TD intercooler	2476	73	02.1999		D4BH	4	G 69
GRANDIS (NA_W)		2.0 Di-D	1968	100	09.2005		BSY	4	GPE 71
L 200		2.3 D 4WD	2346	62	01.1983	10.1986	4 D 55	4	G 11
L 200 (K_T)		2.5 D (K14T)	2476	51	11.1986	08.1996	4 D 56	4	G 69
		2.5 D (K14T)	2476	51	11.1986	08.1996	4 D 56	4	G 69
		2.5 D (K14T)	2476	51	11.1986	08.1996	4 D 56	4	G 11
		2.5 D (K64T)	2477	55	06.1996		4 D 56	4	G 69
		2.5 D 4WD (K24T)	2476	51	12.1987	05.1993	4 D 56	4	G 11
		2.5 TD 4WD (K34T)	2477	64	11.1992	08.1996	4 D 56 T	4	G 69
		2.5 TD 4WD (K34T)	2477	64	11.1992	08.1996	4 D 56 T	4	G 11
		2.5 TD 4WD (K74T)	2477	85	09.2001		4 D 56 T	4	G 69
		2.5 TD 4x4 (K74T)	2477	73	06.1996		4 D 56 TD	4	G 69
		2.5 TD 4x4 (K74T)	2477	74	11.2001		4 D 56 T	4	G 69
L 300 Bus (L03_P/G, L0_2P)		2.3 D (L038P)	2347	50	04.1983	10.1986	4 D 55	4	G 11
L 300 Bus (P0_W, P1_W, P2_W)		2.5 D (P25V, P05W, P05V, P15V, P15T)	2477	51	11.1986		4 D 56	4	G 69
		2.5 D (P25V, P05W, P05V, P15V, P15T)	2477	51	11.1986		4 D 56	4	G 32
		2.5 D (P25V, P05W, P05V, P15V, P15T)	2477	51	11.1986		4 D 56	4	G 11
		2.5 D (P25V, P05W, P05V, P15V, P15T)	2477	51	11.1986		4 D 56	4	G 32
		2.5 TD 4WD (P25W, P25V)	2477	64	11.1988		4 D 56 T	4	G 32
		2.5 TD 4WD (P25W, P25V)	2477	64	11.1988		4 D 56 T	4	G 11
		2.5 TD 4WD (P25W, P25V)	2477	64	11.1988		4 D 56 T	4	G 32
L 300 Camionnette (L03_P)		2.3 D (L038P, L068P)	2347	50	09.1983	10.1986	4 D 55	4	G 11
L 300 Camionnette (P0_W, P1_W)		2.5 D (P05V, P05W, P15V)	2477	51	11.1986		4 D 56	4	G 69
		2.5 D (P05V, P05W, P15V)	2477	51	11.1986		4 D 56	4	G 32
		2.5 D (P05V, P05W, P15V)	2477	51	11.1986		4 D 56	4	G 69
		2.5 D (P05V, P05W, P15V)	2477	51	11.1986		4 D 56	4	G 11
		2.5 D (P05V, P05W, P15V)	2477	51	11.1986		4 D 56	4	G 32
L 300 Camion/Plate-forme (L03_P)		2.5 D (L039P)	2477	51	11.1986	04.1994	4 D 56	4	G 32
		2.5 D (L039P)	2477	51	11.1986	04.1994	4 D 56	4	G 11
L 300 Camion/Plate-forme (P1_T)		2.5 D (P15T)	2477	64	11.1994		4 D 56 T	4	G 69
L 400 Bus (PAOV)		2500 TD	2477	64	06.1996		4 D 56 T	4	G 69
L 400 Camionnette (PAOV)		2500 TD (PD5W, PD5V, PA5W, PA5V)	2477	64	09.1996		4 D 56 T	4	G 69
		2500 TD 4x4 (PD5W, PD5V, PA5W, PA5V)	2477	64	09.1996		4 D 56 T	4	G 69
LANCER III (C1_A, C6_A)		1.8 Diesel (C14AS)	1796	44	09.1986	04.1988	4 D 65	4	G 11
LANCER V (CB/D_A)		2.0 Diesel (CB8A)	1998	50	06.1992		4 D 68	4	G 69
		2.0 Diesel (CB8A)	1998	50	06.1992		4 D 68	4	G 69
LANCER V Station Wagon (CB_W, CD_W)		2.0 D (CB8W)	1998	50	12.1992	10.2003	4 D 68	4	G 69

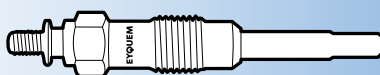



kW



Cyl.



MITSUBISHI

	2.0 D (CB8W)	1998	50	12.1992	10.2003	4 D 68	4	G 69
MONTERO (L04_G, L14_G)	2.5 TD (L044G, L049G)	2477	64	01.1990	12.1991	4 D 56 T	4	G 11
	2.5 TD (L044G, L049G)	2477	70	11.1989	11.1990	4 D 56 T	4	G 11
MONTERO (V3_W, V2_W, V4_W)	2.5 TD 4x4 (V24C, V24W)	2477	73	12.1990	04.2000	4 D 56 TD	4	G 69
	2.5 TD 4x4 (V24C, V24W)	2477	73	12.1990	04.2000	4 D 56 TD	4	G 69
	2.5 TD 4x4 (V24C, V24W)	2477	73	12.1990	04.2000	4 D 56 TD	4	G 11
MONTERO Canvas Top (L04_G)	2.5 TD (L044G, L049G)	2477	62	05.1986	10.1989	4 D 56 T	4	G 11
	2.5 TD (L044G, L049G)	2477	70	11.1989	11.1990	4 D 56 T	4	G 11
MONTERO Canvas Top (V2_W, V4_W)	2.5 TD (V24C, V24W)	2477	73	12.1990	04.2000	4 D 56 TD	4	G 69
	2.5 TD (V24C, V24W)	2477	73	12.1990	04.2000	4 D 56 TD	4	G 69
	2.5 TD (V24C, V24W)	2477	73	12.1990	04.2000	4 D 56 TD	4	G 11
MONTERO III (V60, V70)	2.5 TDi (V64W, V74W)	2477	73	04.2000		4 D 56 T	4	G 69
	2.5 TDi (V64W, V74W)	2477	85	09.2001		4 D 56 T	4	G 69
OUTLANDER II (CW_W)	2.0 Di-D	1968	103	02.2007		BSY	4	GPE 71
	NEW 2.2 Di-D 4WD	2179	115	08.2007	11.2012	4HN/4HK	4	G 88
SPACE GEAR (PA/B/D_V/W)	2.5 TD (PA5V/W, PB5V)	2477	64	05.1995	05.2000	4 D 56 T	4	G 69
	2.5 TD (PA5V/W, PB5V)	2477	73	05.1995	05.2000	4 D 56 TD	4	G 69
	2.5 TD 4x4 (PD5V/W)	2477	73	05.1995	05.2000	4 D 56 TD	4	G 69
SPACE RUNNER (N1_W, N2_W)	2.0 TD (N18W)	1998	60	10.1992	08.1999	4 D 68 T	4	G 69
SPACE WAGON (N3_W, N4_W)	2.0 TD (N38W)	1998	60	10.1992	10.1998	4D68 T	4	G 69

NISSAN

ALMERA I (N15)	2.0 D	1974	55	11.1995	07.2000	CD20	4	G 38
ALMERA I Hatchback (N15)	2.0 D	1974	55	11.1995	03.2000	CD20	4	G 38
ALMERA II (N16)	1.5 dCi	1461	60	01.2003		K9K 722	4	G 28
	2.2 dCi	2184	82	09.2003		YD22DDT	4	G 76
	2.2 Di	2184	81	07.2000		YD22DDT	4	G 76
ALMERA II Hatchback (N16)	1.5 dCi	1461	60	01.2003		K9K 722	4	G 28
	2.2 dCi	2184	82	09.2003		YD22DDT	4	G 76
	2.2 Di	2184	81	03.2000		YD22DDT	4	G 76
ALMERA TINO (V10)	2.2 dCi	2184	82	09.2003		YD22DDT	4	G 76
	2.2 Di	2184	84	08.2000		YD22DDTi	4	G 76
BLUEBIRD (910)	2.0 D	1952	44	01.1980	12.1983	LD20	4	G 49
BLUEBIRD (T72, T12)	2.0 D (SLT72, T12)	1952	49	03.1986	12.1990	LD20	4	G 33
BLUEBIRD Hatchback (T72, T12)	2.0 D (FSLT72, T12)	1952	49	03.1986	12.1990	LD20	4	G 33
CUBE (Z12)	NEW 1.5 dCi	1461	78	03.2010		K9K	4	GPE 78
	NEW 1.5 dCi	1461	81	03.2010		K9K	4	GPE 78
INTERSTAR Bus (X70)	dCi 80	1870	60	07.2002		F9Q 772	4	G 28
	dCi 90	2188	66	07.2002		G9T 722	4	G 63
INTERSTAR Camionnette (X70)	dCi 80	1870	60	07.2002		F9Q 772	4	G 28
	dCi 90	2188	66	07.2002		G9T 722	4	G 63
INTERSTAR Camion/Plate-forme	dCi 120	2463	84	08.2003		G9U 720	4	G 63
JUKE (F15)	NEW 1.5 dCi	1461	81	06.2010		K9K 636	4	GPE 78
KUBISTAR (X76)	1.5 dCi	1461	48	08.2003		K9K 704	4	G 28
KUBISTAR Camionnette	1.5 dCi	1461	48	08.2003		K9K 704	4	G 28
	1.5 dCi	1461	60	08.2003		K9K 722	4	G 28
MICRA II (K11)	1.5 D	1527	42	02.1998	02.2003	TD15	4	G 34
	1.5 D	1527	42	02.1998	02.2003	TD15	4	G 34
	1.5 D	1527	42	02.1998	02.2003	TD15	4	G 34
MICRA III (K12)	1.5 dCi	1461	48	01.2003		K9K 704	4	G 28
	1.5 dCi	1461	60	09.2003		K9K 722	4	G 28
MICRA V (K14)	NEW 1.5 DCI	1461	66	12.2016		K9K 628	4	GPE 78
NAVARA (D40)	2.5 dCi	2488	106	07.2005		YD25DDTi	4	G 76
	2.5 dCi 4WD	2488	128	07.2005		YD25DDTi	4	G 76
NOTE (E11)	1.5 dCi	1461	50	03.2006		K9K 700	4	G 28
	1.5 dCi	1461	63	03.2006		K9K 276	4	G 28
	NEW 1.5 dCi	1461	66	09.2010		K9K 276	4	GPE 78
NOTE II	NEW 1.5 dCi	1461	66	06.2013		K9K 608	4	GPE 78
NP 300 NAVARA (D40)	NEW 2.5 dCi	2488	106	07.2005	01.2010	YD25DDTi	4	G 76
	NEW 2.5 dCi	2488	106	11.2011		YD25DDTi (OE : 1106500Q0H-1106500Q0L)	4	GPE 93
	NEW 2.5 dCi 4WD	2488	106	10.2008	01.2010	YD25DDTi	4	G 76
	NEW 2.5 dCi 4WD	2488	106	11.2011		YD25DDTi (OE : 1106500Q0H-1106500Q0L)	4	GPE 93
	NEW 2.5 dCi 4WD	2488	126	10.2006	01.2010	YD25DDTi	4	G 76
	NEW 2.5 dCi 4WD	2488	126	11.2011		YD25DDTi (OE : 1106500Q0H-1106500Q0L)	4	GPE 93
	NEW 2.5 dCi 4WD	2488	128	07.2005	01.2010	YD25DDTi	4	G 76

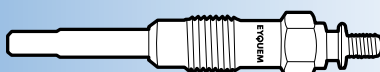



kW



Cyl.



NISSAN										
	NEW	2.5 dCi 4WD	2488	128	11.2011			YD25DDTi (OE : 1106500Q0H-1106500Q0L)	4	GPE 93
	NEW	2.5 dCi 4WD (D40DT, D40T, D40M, D40BB)	2488	140	12.2009	01.2010		YD25DDTi	4	G 76
	NEW	2.5 dCi 4WD (D40DT, D40T, D40M, D40BB)	2488	140	11.2011			YD25DDTi (OE : 1106500Q0H-1106500Q0L)	4	GPE 93
NP 300 NAVARA Camion/ plate-forme (D40)	NEW	2.5 dCi	2488	140	11.2011			YD25DDTi (OE : 1106500Q0H-1106500Q0L)	4	GPE 93
NV200 / EVALIA Bus	NEW	1.5 dCi (M20, M20M)	1461	63	07.2010			K9K 608-400-628 (EURO 4)	4	G 28
	NEW	1.5 dCi (M20, M20M)	1461	63	07.2010			K9K 608-400-628 (EURO 5)	4	GPE 78
	NEW	1.5 dCi (M20, M20M)	1461	66	04.2011			K9K 892	4	GPE 78
	NEW	1.5 dCi (M20, M20M)	1461	81	04.2011			K9K 636-646	4	GPE 78
NV200 / EVALIA Camionnette	NEW	1.5 dCi (M20, M20M)	1461	63	02.2010			K9K 608-400-628 (EURO 4)	4	G 28
	NEW	1.5 dCi (M20, M20M)	1461	63	02.2010			K9K 608-400-628 (EURO 5)	4	GPE 78
	NEW	1.5 dCi (M20, M20M)	1461	66	04.2011			K9K 892	4	GPE 78
	NEW	1.5 dCi (M20, M20M)	1461	81	04.2011			K9K 636-646	4	GPE 78
NV300 Camionnette (X82)	NEW	1.6 dCi 95	1598	70	09.2016			R9M 413	4	GPE 93
	NEW	1.6 dCi 120	1598	89	09.2016			R9M 413	4	GPE 93
	NEW	1.6 dCi 125	1598	92	09.2016			R9M 452	4	GPE 93
	NEW	1.6 dCi 145	1598	107	09.2016			R9M 452	4	GPE 93
NV300 Kombi/bus (X82)	NEW	1.6 dCi 95	1598	70	09.2016			R9M 413	4	GPE 93
	NEW	1.6 dCi 125	1598	92	09.2016			R9M 452	4	GPE 93
	NEW	1.6 dCi 145	1598	107	09.2016			R9M 452	4	GPE 93
PATHFINDER III (R51)	NEW	2.5 dCi 4WD	2488	120	01.2005	01.2010		YD25DDTi	4	G 76
	NEW	2.5 dCi 4WD	2488	120	11.2011			YD25DDTi (OE : 1106500Q0H-1106500Q0L)	4	GPE 93
	NEW	2.5 dCi 4WD	2488	126	10.2006	01.2010		YD25DDTi	4	G 76
	NEW	2.5 dCi 4WD	2488	126	11.2011			YD25DDTi (OE : 1106500Q0H-1106500Q0L)	4	GPE 93
	NEW	2.5 dCi 4WD	2488	128	03.2005	01.2010		YD25DDTi	4	G 76
	NEW	2.5 dCi 4WD	2488	128	11.2011			YD25DDTi (OE : 1106500Q0H-1106500Q0L)	4	GPE 93
		2.5 dCi 4WD	2488	140	11.2011			YD25DDTi (OE : 1106500Q0H-1106500Q0L)	4	GPE 93
PATROL Hardtop (K160)		3.2 D (K160)	3246	70	11.1979	08.1988		SD33	6	G 15
		3.2 D (K160)	3246	70	11.1979	08.1988		SD33	6	G 15
		3.2 TD (K160)	3246	81	07.1983	08.1988		SD33T	6	G 15
PATROL Station Wagon (W160)		3.2 D (W160)	3246	70	11.1979	08.1988		SD33	6	G 15
		3.2 D (W160)	3246	70	11.1979	08.1988		SD33	6	G 15
		3.2 TD (W160)	3246	81	07.1983	08.1988		SD33T	6	G 15
PICK UP (D21)		2.5 D	2494	55	09.1987	02.1998		TD25	4	G 32
		2.5 D	2494	59	09.1994	08.1996		TD25	4	G 32
		2.5 D	2494	61	03.1996	02.1998		TD25	4	G 32
		2.5 D 4WD	2494	59	08.1987	02.1998		TD25	4	G 32
		2.5 D 4WD	2494	61	03.1996	02.1998		TD25	4	G 32
		2.7 D 4WD	2663	73	08.1987	02.1998		TD27	4	G 32
PICK UP (D22)		2.5 D	2494	61	02.1998			TD25	4	G 32
		2.5 D 4WD	2494	61	02.1998			TD25	4	G 32
		2.5 Di	2488	98	03.2002			YD25DDTi	4	G 76
		2.5 Di 4WD	2488	98	03.2002			YD25DDTi	4	G 76
PRIMASTAR Bus (X83)		dCi 100	1870	74	03.2001			F9Q 760	4	G 28
		dCi 140	2463	99	07.2003			G9U 730	4	G 63
		dCi 80	1870	60	03.2001			F9Q 762	4	G 28
PRIMASTAR Camionnette (X83)		dCi 100	1870	74	09.2002			F9Q 760	4	G 28
		dCi 140	2463	99	07.2003			G9U 730	4	G 63
		dCi 80	1870	60	09.2002			F9Q 762	4	G 28
PRIMERA (P10)		2.0 D	1974	55	01.1991	01.1996		CD20	4	G 38
PRIMERA (P11)		2.0 TD	1974	66	09.1996	12.2001		CD20T	4	G 38
PRIMERA (P12)		1.9 dCi	1870	88	04.2003				4	G 28
		2.2 dCi	2184	102	04.2003			YD22DDT	4	G 76
		2.2 Di	2184	93	03.2002			YD22DDT	4	G 76
PRIMERA Hatchback (P10)		2.0 D	1974	55	01.1991	01.1996		CD20	4	G 38
PRIMERA Hatchback (P11)		2.0 TD	1974	66	09.1996	07.2002		CD20T	4	G 38
PRIMERA Hatchback (P12)		1.9 dCi	1870	88	04.2003				4	G 28
		2.2 dCi	2184	102	04.2003			YD22DDT	4	G 76
		2.2 Di	2184	93	07.2002			YD22DDT	4	G 76
PRIMERA Kombi (WP12)		1.9 dCi	1870	88	04.2003				4	G 28
		2.2 dCi	2184	102	04.2003			YD22DDT	4	G 76
		2.2 Di	2184	93	03.2002			YD22DDT	4	G 76
PRIMERA Traveller (W10)		2.0 D	1974	55	07.1990	12.1995		CD20	4	G 38

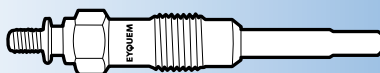



kW



Cyl.

**NISSAN**

PRIMERA Traveller (WP11)	2.0 TD	1974	66	04.1998	12.2001	CD20T	4	G 38
QASHQAI	1.5 dCi	1461	76	07.2008			4	G 28
	1.5 dCi	1461	78	02.2007			4	G 28
QASHQAI (J10-JJ10)	NEW 1.5 dCi	1461	81	11.2010		K9K 430	4	GPE 78
QASHQAI / QASQAI +21(J10-JJ10)	NEW 1.6 dCi	1598	96	10.2011	12.2013	R9M	4	GPE 93
	NEW 1.6 dCi 4WD	1598	96	10.2011	12.2013	R9M	4	GPE 93
QASHQAI II (J11, J11)	NEW 1.5 dCi	1461	81	11.2013		K9K 636	4	GPE 78
	NEW 1.6 dCi	1598	96	11.2013		R9M	4	GPE 93
	NEW 1.6 dCi ALL MODE 4x4-i	1598	96	11.2013		R9M	4	GPE 93
SERENA (C23M)	2.0 D	1952	49	11.1992		LD20	4	G 33
	2.3 D	2283	55	01.1995		LD23	4	G 64
SUNNY II (N13)	1.7 D	1681	40	06.1986	05.1989	CD17	4	G 33
SUNNY II Hatchback (N13)	1.7 D	1681	40	06.1986	01.1991	CD17	4	G 33
SUNNY II Traveller (B12)	1.7 D	1681	40	01.1986	06.1991	CD17	4	G 33
SUNNY III (N14)	2.0 D	1974	55	10.1990	05.1995	CD20	4	G 38
SUNNY III Hatchback (N14)	2.0 D	1974	55	10.1990	05.1995	CD20	4	G 38
SUNNY III Liftback (N14)	2.0 D	1974	55	10.1990	05.1995	CD20	4	G 38
SUNNY III Traveller (Y10)	2.0 D	1974	55	06.1991	03.2000	CD20	4	G 38
SUNNY Camionnette (Y10)	1.7 D	1681	40	11.1990	03.2000	CD17	4	G 33
	1.7 D	1681	40	11.1990	03.2000	CD17	4	G 33
TIIDA	1.5 dCi	1461	78	09.2007		K9K 728	4	G 28
URVAN Bus (E23)	2.3 D (E23B)	2289	51	04.1985	11.1988	SD23	4	G 15
URVAN Bus (E24)	2.5 D	2494	59	05.1989	10.1996	TD25	4	G 32
URVAN Camionnette (E23)	2.3 D	2289	50	11.1982	05.1987	SD23	4	G 15
URVAN Camionnette (E24)	2.3 D	2289	51	01.1988	05.1997	TD23	4	G 32
	2.5 D	2494	59	12.1988	05.1997	TD25	4	G 32
VANETTE Bus (C22)	2.0 D (ULC22)	1952	47	10.1986	12.1995	LD20	4	G 33
	2.0 D (ULC22)	1952	49	10.1986	12.1995	LD20	4	G 33
VANETTE Camionnette (C22)	2.0 D	1952	49	07.1991	01.1995	LD20II	4	G 33
VANETTE CARGO Bus (HC 23)	2.3 D	2283	55	01.1996		LD23	4	G 64
VANETTE CARGO Camionnette (HC 23)	2.3 D	2283	55	01.1995		LD23	4	G 64
X-TRAIL (T30)	2.2 Di 4x4	2184	84	07.2001		YD22ETI	4	G 76
X-TRAIL (T32)	NEW 1.6 dCi (T32)	1598	96	04.2014		R9M	4	GPE 93
	NEW 1.6 dCi ALL MODE 4x4-i (NT32)	1598	96	04.2014		R9M	4	GPE 93
	NEW 2.0 dCi ALL MODE 4x4-i (NTR2)	1995	130	10.2016		R9M	4	GPE 93

OPEL

AGILA	1.3 CDTI	1248	55	09.2007		Z 13 DTJ	4	G 7
AGILA (H00)	1.3 CDTI	1248	51	08.2003	12.2007	Z 13 DT	4	G 7
	1.3 CDTI	1248	55	04.2008		Z 13 DTJ/ D13A	4	G 7
ARENA Combi (THB)	1.9 D	1870	44	03.1998	08.2001	F8Q 600-606	4	G 54
	1.9 D	1870	44	01.1997	12.2001	19 DJ/19DL	4	G 54
	2.5 D	2499	55	01.1997	12.2001	25 DG/25 DM	4	G 35
	2.5 D	2499	55	03.1998	08.2001	S8U 758-780-782	4	G 35
ARENA Camionnette (TB, TF)	1.9 D	1870	44	01.1997	12.2001	19 DJ/19DL	4	G 54
	1.9 D	1870	44	03.1998	08.2001	F8Q 600-606	4	G 54
	2.5 D	2499	55	01.1997	12.2001	25 DG/25 DM	4	G 35
	2.5 D	2499	55	03.1998	08.2001	S8U 758-780-782	4	G 35
ASCONA B (81_, 86_, 87_, 88_)	2.0 D	1998	43	08.1978	08.1981	20 D	4	G 41
ASCONA C (81_, 86_, 87_, 88_)	1.6 D	1598	40	03.1982	08.1988	16 DA/16 D	4	G 41
ASCONA C CC (84_, 89_)	1.6 D	1598	40	03.1982	08.1988	16 DA/16 D	4	G 41
ASTRA F (53_, 54_, 58_, 59_)	1.7 D	1700	42	12.1991	09.1992	17 D	4	G 41
	1.7 D	1700	44	07.1992	01.1998	17 DR	4	G 41
	1.7 TD	1700	50	11.1994	01.1998	X 17 DTL	4	G 41
	1.7 TDS	1686	60	12.1991	01.1998	17 DT /X 17 DT (TC4EE1) engine n°->956632	4	G 48
	1.7 TDS	1686	60	12.1991	01.1998	17 DT /X 17 DT (TC4EE1) engine n°956633->	4	G 67
ASTRA F (56_, 57_)	1.7 D	1700	42	03.1992	09.1992	17 D	4	G 41
	1.7 D	1700	44	07.1992	09.1998	17 DR	4	G 41
	1.7 TD	1700	50	11.1994	09.1998	X 17 DTL	4	G 41
	1.7 TDS	1686	60	03.1992	09.1998	17 DT /X 17 DT (TC4EE1) engine n°->956632	4	G 48
	1.7 TDS	1686	60	03.1992	09.1998	17 DT /X 17 DT (TC4EE1) engine n°956633->	4	G 67
ASTRA F Caravan (51_, 52_)	1.7 D	1700	42	12.1991	09.1992	17 D	4	G 41
	1.7 D	1700	44	07.1992	01.1998	17 DR	4	G 41
	1.7 TD	1700	50	11.1994	01.1998	X 17 DTL	4	G 41
	1.7 TDS	1686	60	12.1991	01.1998	17 DT /X 17 DT (TC4EE1) engine n°->956632	4	G 48

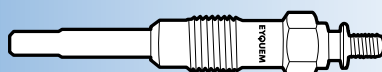



kW



Cyl.



OPEL

	1.7 TDS	1686	60	12.1991	01.1998	17 DT / X 17 DT (TC4EE1) engine n°956633->	4	G 67
ASTRA F CLASSIC CC	1.7 TD	1699	50	03.1998	08.2000	X 17 DTL	4	G 41
	1.7 TD	1699	50	03.1998	08.2000	X 17 DTL	4	G 41
	1.7 TD	1699	50	03.1998	08.2000	X 17 DTL	4	G 41
ASTRA F Van (55_)	1.7 D	1686	42	12.1991	09.1992	17 D	4	G 41
	1.7 D	1686	44	07.1992	01.1999	17 DR	4	G 41
	1.7 TD	1686	50	08.1994	01.1999	X 17 DTL	4	G 41
	1.7 TD	1686	60	03.1995	02.1998	X 17 DT (TC4EE1)	4	G 48
ASTRA G Cabriolet (F67_)	2.2 DTI	2172	92	09.2002	10.2005	Y 22 DTR	4	G 3
ASTRA G Caravan (F35_)	1.7 CDTI	1686	59	04.2003	07.2009	Z 17 DTL	4	G 68
	1.7 DTI 16V	1686	55	02.2000	07.2004	Y 17 DT	4	G 68
	1.7 TD	1700	50	02.1998	08.2000	X 17 DTL	4	G 41
	2.0 DI	1995	60	02.1998	07.2004	X 20 DTL/Y 20 DTL	4	G 56
	2.0 DTI 16V	1995	74	08.1999	08.2002	Y 20 DTH/X 20 DTH	4	G 56
	2.0 DTI 16V	1995	74	09.2002	07.2004	Y 20 DTH/X 20 DTH	4	G 3
	2.2 DTI	2172	86	09.2002	07.2004	Y 22 DTR	4	G 3
	2.2 DTI	2172	92	09.2002	07.2004	Y 22 DTR	4	G 3
ASTRA G CC (F48_, F08_)	1.7 DTI 16V	1686	55	02.2000	01.2005	Y 17 DT	4	G 68
	1.7 CDTI	1686	59	04.2003	01.2005	Z 17 DTL	4	G 68
	1.7 TD	1700	50	02.1998	08.2000	X 17 DTL	4	G 41
	2.0 DI	1995	60	02.1998	01.2005	X 20 DTL/Y 20 DTL	4	G 56
	2.0 DTI 16V	1995	74	08.1999	08.2002	Y 20 DTH/X 20 DTH	4	G 56
	2.0 DTI 16V	1995	74	09.2002	01.2005	Y 20 DTH/X 20 DTH	4	G 3
	2.2 DTI	2172	86	09.2002	01.2005	Y 22 DTR	4	G 3
	2.2 DTI	2172	92	09.2002	01.2005	Y 22 DTR	4	G 3
ASTRA G Coupe (F07_)	2.2 DTI	2172	92	09.2002	05.2005	Y 22 DTR	4	G 3
ASTRA G Camionnette (F70)	1.7 TD	1700	50	01.1999	04.2005	X 17 DTL	4	G 41
	1.7 DTI 16V	1686	55	02.2000	04.2005	Y 17 DT	4	G 68
	2.0 DI	1995	60	01.1999	04.2005	X 20 DTL	4	G 56
ASTRA G Tricorps (F69_)	1.7 CDTI	1686	59	04.2003	01.2005	Z 17 DTL	4	G 68
	1.7 DTI 16V	1686	55	02.2000	01.2005	Y 17 DT	4	G 68
	1.7 TD	1700	50	09.1998	08.2000	X 17 DTL	4	G 41
	2.0 DI	1995	60	09.1998	01.2005	X 20 DTL/Y 20 DTL	4	G 56
	2.0 DTI 16V	1995	74	08.1999	08.2003	Y 20 DTH/X 20 DTH	4	G 56
	2.0 DTI 16V	1995	74	09.2003	01.2005	Y 20 DTH/X 20 DTH	4	G 3
	2.2 DTI	2172	86	09.2002	01.2005	Y 22 DTR	4	G 3
	2.2 DTI	2172	92	09.2002	05.2005	Y 22 DTR	4	G 3
	2.2 DTI	2172	92	09.2002	01.2005	Y 22 DTR	4	G 3
ASTRA H (L48)	1.3 CDTI	1248	66	08.2005	10.2010	Z 13 DTH	4	G 7
	1.7 CDTI	1686	59	03.2004	10.2010	Z 17 DTL	4	G 68
	1.7 CDTI	1686	74	03.2004	10.2010	Z 17 DTH	4	G 68
	1.7 CDTI	1686	81	02.2007	05.2014	A 17 DTJ/Z 17 DTJ	4	G 68
	1.7 CDTI	1686	92	02.2007	05.2014	A 17 DTR/Z 17 DTR	4	G 68
	1.9 CDTI	1910	74	09.2005	10.2010	Z 19 DTL chassis n°->72045139, 75030986, 78007391, 7G	4	G 60
NEW	1.9 CDTI	1910	74	09.2005	10.2010	Z 19 DTL chassis 72045140, 75030987, 78007392, 8B000001->	4	G 89
	1.9 CDTI 16V	1910	88	04.2004	10.2010	Z 19 DTJ	4	G 8
	1.9 CDTI	1910	88	06.2004	10.2010	Z 19 DT chassis n°->72045139, 75030986, 78007391, 7G	4	G 60
NEW	1.9 CDTI	1910	88	06.2004	10.2010	Z 19 DT chassis 72045140, 75030987, 78007392, 8B000001->	4	G 89
	1.9 CDTI	1910	110	09.2004	10.2010	Z 19 DTH	4	G 8
ASTRA H A (L69)	1.7 CDTI	1686	81	02.2007	05.2014	Z 17 DTJ	4	G 68
	1.7 CDTI	1686	92	02.2007	05.2014	A 17 DTR/Z 17 DTR	4	G 68
ASTRA H Caravan (L35)	1.3 CDTI	1248	66	08.2005	10.2010	Z 13 DTH	4	G 7
	1.7 CDTI	1686	59	08.2004	10.2010	Z 17 DTL	4	G 68
	1.7 CDTI	1686	74	08.2004	10.2010	Z 17 DTH	4	G 68
	1.7 CDTI	1686	81	02.2007	05.2014	A 17 DTJ/Z 17 DTJ	4	G 68
	1.7 CDTI	1686	92	02.2007	05.2014	A 17 DTR/Z 17 DTR	4	G 68
	1.9 CDTI	1910	74	09.2005	10.2010	Z 19 DTL chassis n°->72045139, 75030986, 78007391, 7G	4	G 60
NEW	1.9 CDTI	1910	74	09.2005	10.2010	Z 19 DTL chassis 72045140, 75030987, 78007392, 8B000001->	4	G 89
	1.9 CDTI 16V	1910	88	08.2004	10.2010	Z 19 DTJ	4	G 8

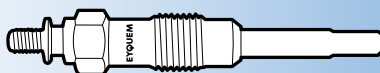



kW



Cyl.



OPEL

	1.9 CDTi	1910	88	09.2005	10.2010	Z 19 DT chassis n°->72045139, 75030986, 78007391, 7G	4	G 60
	NEW 1.9 CDTi	1910	88	09.2005	10.2010	Z 19 DT chassis 72045140, 75030987, 78007392, 8B000001->	4	G 89
ASTRA H GTC (L08)	1.9 CDTi	1910	110	09.2004	10.2010	Z 19 DTH	4	G 8
	1.3 CDTi	1248	66	04.2005	10.2010	Z 13 DTH	4	G 7
	1.7 CDTi	1686	59	03.2005	10.2010	Z 17 DTL	4	G 68
	1.7 CDTi	1686	74	03.2005	10.2010	Z 17 DTH	4	G 68
	1.7 CDTi	1686	81	02.2007	10.2010	A 17 DTJ	4	G 68
	1.7 CDTi	1686	92	02.2007	10.2010	A 17 DTR	4	G 68
	1.9 CDTi	1910	74	01.2006		Z 19 DTL chassis n°->72045139, 75030986, 78007391, 7G	4	G 60
	NEW 1.9 CDTi	1910	74	01.2006		Z 19 DTL chassis 72045140, 75030987, 78007392, 8B000001->	4	G 89
	1.9 CDTi 16V	1910	88	03.2005	10.2010	Z 19 DTJ	4	G 8
	1.9 CDTi	1910	88	09.2005		Z 19 DT chassis n°->72045139, 75030986, 78007391, 7G	4	G 60
	NEW 1.9 CDTi	1910	88	09.2005		Z 19 DT chassis 72045140, 75030987, 78007392, 8B000001->	4	G 89
ASTRA H Camionnette (L70)	1.9 CDTi	1910	110	03.2005	10.2010	Z 19 DTH	4	G 8
	1.3 CDTi	1248	66	08.2005	10.2010	Z 13 DTH	4	G 7
	1.7 CDTi	1686	74	03.2004	10.2010	Z 17 DTH	4	G 68
	1.7 CDTi	1686	81	02.2007	10.2010	A 17 DTJ	4	G 68
	1.7 CDTi	1686	92	02.2007	10.2010	A 17 DTR/Z 17 DTR	4	G 68
	1.9 CDTi	1910	88	09.2005	10.2010	Z 19 DT chassis n°->72045139, 75030986, 78007391, 7G	4	G 60
	NEW 1.9 CDTi	1910	88	09.2005	10.2010	Z 19 DT chassis 72045140, 75030987, 78007392, 8B000001->	4	G 89
	1.9 CDTi	1910	88	08.2004	10.2010	Z 19 DTJ	4	G 8
	1.9 CDTi	1910	110	09.2004	10.2010	Z 19 DTH	4	G 8
ASTRA H Tricorps	1.3 CDTi	1248	66	02.2007		Z 13 DTH	4	G 7
ASTRA H TwinTop (L67)	1.9 CDTi	1910	110	09.2005	10.2010	Z 19 DTH	4	G 8
ASTRA J GTC	NEW 1.6 CDTi (08)	1598	81	07.2014		B 16 DTL	4	GPE 94
	NEW 1.6 CDTi (08)	1598	100	01.2014		B 16 DTH	4	GPE 94
	1.7 CDTi	1686	81	10.2011		A 17 DTJ	4	G 68
	NEW 1.7 CDTi	1686	81	10.2011		A 17 DTC	4	GPE 90
	NEW 1.7 CDTi	1686	96	10.2011		A 17 DTS	4	GPE 90
	NEW 2.0 CDTi	1956	121	10.2011		A 20 DTH chassis n°->B3999999, B8999999, BG999999	4	GPE 82
	NEW 2.0 BiTurbo CDTi	1956	143	10.2012		A 20 DTR chassis n°->B3999999, B8999999, BG999999	4	GPE 82
ASTRA J (P10)	NEW 1.3 CDTi	1248	70	12.2009		A 13 DTE chassis n°C0000001,C1000001, C3000001,C8000001,CG000001->	4	GPE 80
	NEW 1.3 CDTi	1248	70	12.2009		A 13 DTE chassis n°->B3999999, B8999999, BG999999	2	GPE 80
	NEW 1.6 CDTi (68)	1598	81	02.2014		B 16 DTL	4	GPE 94
	NEW 1.6 CDTi (68)	1598	100	01.2014		B 16 DTH	4	GPE 94
	1.7 CDTi	1686	74	10.2010		A 17 DTL	4	G 68
	1.7 CDTi	1686	81	12.2009		A 17 DTJ	4	G 68
	NEW 1.7 CDTi	1686	81	12.2009		A 17 DTC	4	GPE 90
	1.7 CDTi	1686	92	12.2009		A 17 DTR	4	G 68
	NEW 1.7 CDTi	1686	96	12.2009		A 17 DTS	4	GPE 90
	NEW 2.0 CDTi	1956	118	12.2009		A 20 DTH chassis n°->B3999999, B8999999, BG999999	4	GPE 82
	NEW 2.0 CDTi	1956	121	06.2011		A 20 DTH chassis n°->B3999999, B8999999, BG999999	4	GPE 82
	NEW 2.0 BiTurbo CDTi	1956	143	12.2012		A 20 DTR chassis n°->B3999999, B8999999, BG999999	4	GPE 82
ASTRA J A	NEW 1.3 CDTi	1248	70	06.2012		A 13 DTE chassis n°C0000001,C1000001, C3000001,C8000001,CG000001->	4	GPE 80
	NEW 1.3 CDTi	1248	70	06.2012		A 13 DTE chassis n°->B3999999, B8999999, BG999999	2	GPE 80
	1.7 CDTi	1686	81	06.2012		A 17 DTJ	4	G 68
	NEW 1.6 CDTi (69)	1598	81	04.2014		B 16 DTL	4	GPE 94
	NEW 1.6 CDTi (69)	1598	100	01.2014		B 16 DTH	4	GPE 94

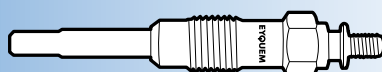



kW



Cyl.



OPEL									
	NEW	1.7 CDTI	1686	81	06.2012		A 17 DTC	4	GPE 90
	NEW	1.7 CDTI	1686	96	06.2012		A 17 DTS	4	GPE 90
ASTRA J Sports Tourer (P10)	NEW	1.3 CDTI	1248	70	10.2010		A 13 DTE chassis n°C0000001,C1000001, C3000001,C8000001,CG000001->	4	GPE 80
	NEW	1.3 CDTI	1248	70	10.2010		A 13 DTE chassis n°->B3999999,B8999999, BG999999	2	GPE 80
	NEW	1.6 CDTi (35)	1598	81	02.2014		B 16 DTL	4	GPE 94
	NEW	1.6 CDTi (35)	1598	100	01.2014		B 16 DTH	4	GPE 94
		1.7 CDTI	1686	74	10.2010		A 17 DTL/ A 17DTN	4	G 68
		1.7 CDTI	1686	81	10.2010		A 17 DTJ	4	G 68
	NEW	1.7 CDTI	1686	81	10.2010		A 17 DTC	4	GPE 90
		1.7 CDTI	1686	92	10.2010		A 17 DTR	4	G 68
	NEW	1.7 CDTI	1686	96	10.2010		A 17 DTS	4	GPE 90
	NEW	2.0 CDTI	1956	118	10.2010		A 20 DTH chassis n°->B3999999,B8999999,BG999999	4	GPE 82
	NEW	2.0 CDTI	1956	121	08.2011		A 20 DTH chassis n°->B3999999,B8999999,BG999999	4	GPE 82
	NEW	2.0 BiTurbo CDTI	1956	143	12.2012		A 20 DTR chassis n°->B3999999,B8999999,BG999999	4	GPE 82
ASTRA K (B16)	NEW	1.6 CDTi (68)	1598	70	06.2015		B 16 DTE	4	GPE 94
	NEW	1.6 CDTi (68)	1598	81	06.2015		B 16 DTU	4	GPE 94
	NEW	1.6 CDTi (68)	1598	100	06.2015		B 16 DTH	4	GPE 94
	NEW	1.6 CDTi (68)	1598	118	11.2015		B 16 DTR	4	GPE 94
ASTRA K Sports Tourer (B16)	NEW	1.6 CDTi (35)	1598	70	11.2015		B 16 DTE	4	GPE 94
	NEW	1.6 CDTi (35)	1598	81	11.2015		B 16 DTU-B 16 DTE	4	GPE 94
	NEW	1.6 CDTi (35)	1598	100	11.2015		B 16 DTH	4	GPE 94
	NEW	1.6 CDTi (35)	1598	118	11.2015		B 16 DTR	4	GPE 94
CAMPO (TF_)		2.2 D (TFR52)	2238	39	08.1991	09.1996	C223	4	G 47
		2.2 D 4x4 (TFS52)	2238	39	08.1991	09.1996	C223	4	G 47
		2.2 D (TFR52)	2238	45	08.1987	08.1990	C223	4	G 47
		2.2 D 4x4 (TFS52)	2238	45	08.1987	08.1990	C223	4	G 47
		3.1 TD (TFR69)	3059	80	03.1995	12.1996	4 JG2T	4	G 48
		3.1 TD 4x4 (TFS69)	3059	80	03.1995	12.1996	4 JG2T	4	G 48
COMBO (71_)		1.7 D	1686	44	07.1994	10.2001	17 D (4EE1)/X 17 D (4EE1)	4	G 67
COMBO Camionnette/Kombi		1.3 CDTI 16V	1248	51	08.2005		Z 13 DT	4	G 7
		1.3 CDTI 16V	1248	55	10.2005		Z 13 DTJ	4	G 7
		1.7 DI 16V	1686	48	10.2001		Y 17 DTL	4	G 68
		1.7 DTI 16V	1686	55	10.2001		Y 17 DT	4	G 68
		1.7 CDTI 16V	1686	74	12.2004		Z 17 DTH	4	G 68
COMBO Camionnette (X12)	NEW	1.6 CDTI	1598	66	02.2012		A 16 FDL	4	GPE 82
	NEW	1.6 CDTI	1598	70	10.2015		A 16 FDL	4	GPE 82
	NEW	1.6 CDTI	1598	74	02.2012		A 16 FDH	4	GPE 82
	NEW	1.6 CDTI	1598	77	02.2012		A 16 FDH	4	GPE 82
	NEW	1.6 CDTI	1598	88	03.2016		A 16 FDL	4	GPE 82
	NEW	2.0 CDTI	1956	99	02.2012		A 20 FD	4	GPE 82
COMBO Camionnette/ Kombi (X12)	NEW	1.3 CDTI	1248	66	02.2012		A 13 FD (Euro V)	4	GPE 80
	NEW	1.6 CDTI	1598	66	02.2012		A 16 FDL	4	GPE 82
	NEW	1.6 CDTI	1598	70	10.2015		A 16 FDL	4	GPE 82
	NEW	1.6 CDTI	1598	74	02.2012		A 16 FDH	4	GPE 82
	NEW	1.6 CDTI	1598	77	02.2012		A 16 FDH	4	GPE 82
	NEW	1.6 CDTI	1598	88	03.2016		A 16 FDL	4	GPE 82
	NEW	2.0 CDTI	1956	99	02.2012		A 20 FD	4	GPE 82
COMBO camion plate-forme chassis (X12)	NEW	2.0 CDTI	1956	99	08.2012		A 20 FD	4	GPE 82
COMBO Tour		1.3 CDTI 16V	1248	51	10.2004		Y 13 DT/Z 13 DT	4	G 7
		1.3 CDTI 16V	1248	55	10.2005		Z 13 DTJ	4	G 7
		1.7 DI 16V	1686	48	10.2001		Y 17 DTL	4	G 68
		1.7 DTI 16V	1686	55	10.2001		Y 17 DT	4	G 68
		1.7 CDTI 16V	1686	74	12.2004		Z 17 DTH	4	G 68
COMBO Tour (X12)	NEW	1.3 CDTI	1248	66	02.2012		A 13 FD	4	GPE 80
	NEW	1.6 CDTI	1598	66	02.2012		A 16 FDL	4	GPE 82
	NEW	1.6 CDTI	1598	74	02.2012		A 16 FDH	4	GPE 82
	NEW	1.6 CDTI	1598	77	02.2012		A 16 FDH	4	GPE 82
	NEW	2.0 CDTI	1956	99	02.2012		A 20 FD	4	GPE 82
CORSA A CC (93_, 94_, 98_, 99_)		1.5 D	1488	37	09.1987	03.1993	15 D (4EC1) engine->804794	4	G 45
		1.5 D	1488	37	09.1987	03.1993	15 D (4EC1) engine 804795->	4	G 47
		1.5 TD	1488	49	03.1988	03.1993	15 DT (T4EC1) engine->804794	4	G 46





kW



Cyl.



OPEL

	1.5 TD	1488	49	03.1988	03.1993	15 DT (T4EC1) engine 804795->	4	G 48
CORSA A Camionnette	1.5 D	1488	37	06.1987	04.1989	15 D (4EC1) engine->804794	4	G 45
	1.5 D	1488	37	06.1987	04.1989	15 D (4EC1) engine 804795->	4	G 47
CORSA A TR (91_, 92_, 96_, 97_)	1.5 D	1488	37	10.1987	11.1992	15 D (4EC1) engine->804794	4	G 45
	1.5 D	1488	37	10.1987	11.1992	15 D (4EC1) engine 804795->	4	G 47
	1.5 TD	1488	49	10.1987	03.1993	15 DT (T4EC1) engine->804794	4	G 46
CORSA B (73_, 78_, 79_)	1.5 TD	1488	49	10.1987	03.1993	15 DT (T4EC1) engine 804795->	4	G 48
	1.5 D	1488	37	03.1993	09.2000	15 D (4EC1)	4	G 67
	1.5 TD	1488	49	03.1993	09.2000	X 15 DT (T4EC1)/15 DT (T4EC1)	4	G 67
	1.7 D	1686	44	02.1996	09.2000	17 D (4EE1)/X 17 D (4EE1)	4	G 67
CORSA B Camionnette (73_)	1.7 D	1686	44	08.1999	09.2000	17 D (4EE1)/X 17 D (4EE1)	4	G 67
CORSA B Kombi (F35)	1.7 D	1686	44	01.1999		X 17 D (4EE1)	4	G 67
CORSA C (F08, F68)	1.3 CDTI	1248	51	06.2003	12.2009	Z 13 DT	4	G 7
	1.7 CDTI	1686	74	06.2003	09.2006	Z 17 DTH	4	G 68
	1.7 DI	1686	48	09.2000	12.2009	Y 17 DTL	4	G 68
	1.7 DTI	1686	55	09.2000	12.2009	Y 17 DT	4	G 68
CORSA C Camionnette (F08, W5L)	1.3 CDTI 16V	1248	51	08.2005		Z 13 DT	4	G 7
	1.7 CDTi	1686	74	08.2003	09.2006	Z 17 DTH	4	G 68
	1.7 DI 16V	1686	48	09.2000		Y 17 DTL	4	G 68
	1.7 DTI 16V	1686	55	09.2000		Y 17 DT	4	G 68
CORSA D (S07)	1.3 CDTI	1248	55	07.2006		Z 13 DTJ	4	G 7
	NEW 1.3 CDTI	1248	55	07.2006		A 13 DTC	2	GPE 80
	1.3 CDTI	1248	66	07.2006		Z 13 DTH	4	G 7
	NEW 1.3 CDTI	1248	70	06.2010		A 13 DTE/A 13 DTR/Z 13 DTE	4	GPE 80
	1.7 CDTI	1686	92	07.2006		Z 17 DTR	4	G 68
	NEW 1.7 CDTI	1686	96	06.2010		A 17 DTS	4	GPE 90
CORSA D Van (S07)	1.3 CDTI	1248	55	07.2006		Z 13 DTJ	4	G 7
	NEW 1.3 CDTI	1248	55	07.2006		A 13 DTC	2	GPE 80
	1.3 CDTI	1248	66	07.2006		Z 13 DTH	4	G 7
	NEW 1.3 CDTI	1248	70	06.2010		A 13 DTR/Z 13 DTE	4	GPE 80
FRONTERA A (5_MWL4)	2.3 TD (5JMWL4)	2260	74	03.1992	10.1998	23 DTR	4	G 41
	2.5 TDS	2499	85	09.1996	10.1998	25TDS (VM41B)	4	G 40
FRONTERA A Sport (5_SUD2)	2.5 TDS	2499	85	09.1996	10.1998	25TDS (VM41B)	4	G 40
FRONTERA B (6B_)	2.2 DTI(6B_ZC, 6B_VF, 6B_66, 6B_76)	2171	85	10.1998	08.2000	X 22 DTH/Y 22 DTH chassis n°->VY 699999	4	G 56
	2.2 DTI(6B_ZC, 6B_VF, 6B_66, 6B_76)	2171	85	09.2000	09.2002	X 22 DTH/Y 22 DTH	4	G 3
	2.2 DTI	2171	88	09.2002		Y 22 DTH	4	G 3
INSIGNIA A (G09)	NEW 2.0 CDTI	1956	81	07.2008		A 20 DTC/A 20 DTL	2	GPE 82
	NEW 2.0 CDTI	1956	96	07.2008		A 20 DT/A 20 DTJ	2	GPE 82
	NEW 2.0 CDTI	1956	118	07.2008		A 20 DTH	2	GPE 82
	NEW 2.0 CDTI 4x4	1956	118	06.2010		A 20 DTH	2	GPE 82
	NEW 2.0 CDTI	1956	120	07.2013		A 20 DTH	2	GPE 82
	NEW 2.0 CDTI 4x4	1956	120	07.2013		A 20 DTH	2	GPE 82
INSIGNIA A A Saloon (G09)	NEW 2.0 CDTI	1956	81	07.2008		A 20 DTC/A 20 DTL	2	GPE 82
	NEW 2.0 CDTI	1956	96	07.2008		A 20 DT/A 20 DTJ	2	GPE 82
	NEW 2.0 CDTI	1956	118	07.2008		A 20 DTH	2	GPE 82
	NEW 2.0 CDTI 4x4	1956	118	06.2010		A 20 DTH	2	GPE 82
	NEW 2.0 CDTI	1956	120	07.2013		A 20 DTH	2	GPE 82
	NEW 2.0 CDTI 4x4	1956	120	07.2013		A 20 DTH	2	GPE 82
INSIGNIA A Country Tourer (G09)	NEW 2.0 CDTI	1956	96	02.2009		A 20 DT/A 20 DTJ chassis n°->B3999999, B8999999, BG999999	2	GPE 82
	NEW 2.0 CDTI	1956	120	07.2014		A 20 DTH	2	GPE 82
	NEW 2.0 CDTI 4x4	1956	120	09.2013		A 20 DTH	2	GPE 82
INSIGNIA A Sports Tourer (G09)	NEW 2.0 CDTI	1956	81	07.2008	06.2013	A 20 DTC/A 20 DTL	2	GPE 82
	NEW 2.0 CDTI	1956	96	07.2008	06.2015	A 20 DT/A 20 DTJ	2	GPE 82
	NEW 2.0 CDTI	1956	118	07.2008	06.2015	A 20 DTH	2	GPE 82
	NEW 2.0 CDTI 4x4	1956	118	06.2010	06.2015	A 20 DTH	2	GPE 82
	NEW 2.0 CDTI	1956	120	07.2013	06.2015	A 20 DTH	2	GPE 82
	NEW 2.0 CDTI 4x4	1956	120	07.2013	06.2015	A 20 DTH	2	GPE 82
INSIGNIA B Grand Sport (Z18)	NEW 1.6 CDTI (68)	1598	81	03.2017		B 16 DTE- D 16 DTE	4	GPE 94
	NEW 1.6 CDTI (68)	1598	100	03.2017		B 16 DTH- D 16 DTH	4	GPE 94
INSIGNIA B Sports Tourer (Z18)	NEW 1.6 CDTI (35)	1598	81	03.2017		B 16 DTE- D 16 DTE	4	GPE 94
	NEW 1.6 CDTI (35)	1598	100	03.2017		B 16 DTH- D 16 DTH	4	GPE 94
KADETT D (31_-34_, 41_-44_)	1.6 D	1598	40	03.1982	08.1984	16 D	4	G 41
KADETT D (32_, 37_, 39_, 42)	1.6 D	1598	40	03.1982	08.1984	16 D	4	G 41





kW



Cyl.



OPEL									
KADETT D Caravan (35_, 36_, 45_, 46_)	1.6 D	1598	40	03.1982	08.1984	16 D	4	G 41	
KADETT E (39_, 49_)	1.5 TD	1488	53	07.1988	08.1991	15 DT (T4EC1) engine n°->817252	4	G 46	
	1.5 TD	1488	53	07.1988	08.1991	15 DT (T4EC1) engine n°817253->	4	G 48	
	1.6 D	1598	40	09.1984	01.1989	16 DA/16 D	4	G 41	
	1.7 D	1700	42	02.1989	08.1991	17 D	4	G 41	
KADETT E Caravan (35_, 36_, 45_, 46_)	1.5 TD	1488	53	07.1988	08.1991	15 DT (T4EC1) engine n°->817252	4	G 46	
	1.5 TD	1488	53	07.1988	08.1991	15 DT (T4EC1) engine n°817253->	4	G 48	
	1.6 D	1598	40	09.1984	01.1989	16 DA/16 D	4	G 41	
	1.7 D	1700	42	02.1989	08.1991	17 D	4	G 41	
KADETT E CC (33_, 34_, 43_, 44_)	1.5 TD	1488	53	07.1988	08.1991	15 DT (T4EC1) engine n°->817252	4	G 46	
	1.5 TD	1488	53	07.1988	08.1991	15 DT (T4EC1) engine n°817253->	4	G 48	
	1.6 D	1598	40	09.1984	01.1989	16 DA/16 D	4	G 41	
	1.7 D	1700	42	02.1989	08.1991	17 D	4	G 41	
KADETT E Combo (38_, 48_)	1.6 D	1598	40	01.1986	12.1989	16 DA	4	G 41	
	1.7 D	1700	42	01.1989	07.1994	17 D	4	G 41	
	1.7 D	1700	44	07.1992	07.1994	17 DR	4	G 41	
KADETT E Camionnette (37_, 47_)	1.6 D	1598	40	08.1984	08.1988	16 DA/16 D	4	G 41	
	1.7 D	1700	42	08.1988	09.1992	17 D	4	G 41	
MERIVA A (X03)	1.3 CDTI	1248	51	04.2005	05.2010	Y 13 DT/Z 13 DT	4	G 7	
	1.3 CDTI	1248	55	09.2003	05.2010	Z 13 DTJ	4	G 7	
	1.7 CDTI	1686	74	09.2003	05.2010	Z 17 DTH	4	G 68	
	1.7 CDTI	1686	92	09.2006	05.2010	A 17 DTR/Z 17 DTR	4	G 68	
	1.7 DTI	1686	55	09.2003	05.2010	Y 17 DT	4	G 68	
MERIVA B (S10)	NEW 1.3 CDTI	1248	55	06.2010		A 13 DTC	2	GPE 80	
	NEW 1.3 CDTI	1248	70	06.2010		A 13 DTE	2	GPE 80	
	NEW 1.6 CDTI (75)	1598	70	01.2014		B 16 DTC	4	GPE 94	
	NEW 1.6 CDTI (75)	1598	81	03.2014		B 16 DTL-DTE-DTN	4	GPE 94	
	NEW 1.6 CDTI (75)	1598	100	08.2013		B 16 DTH	4	GPE 94	
	1.7 CDTI	1686	74	06.2010		A 17 DT	4	G 68	
	1.7 CDTI	1686	81	06.2010		A 17 DTI	4	G 68	
	NEW 1.7 CDTI	1686	81	06.2010		A 17 DTC	4	GPE 90	
	NEW 1.7 CDTI	1686	96	06.2010		A 17 DTS	4	GPE 90	
MOKKA / MOKKA X (J13)	NEW 1.6 CDTI (_76)	1598	100	01.2015		B 16 DTH	4	GPE 94	
	NEW 1.6 CDTI 4x4 (_76)	1598	100	01.2015		B 16 DTH	4	GPE 94	
	NEW 1.7 CDTI	1686	96	11.2012		A 17 DTS	4	GPE 90	
	NEW 1.7 CDTI 4x4	1686	96	11.2012		A 17 DTS	4	GPE 90	
MONTEREY A (UBS_)	3.1 TD (UBS69_)	3059	84	09.1991	12.1997	4 JG2TC	4	G 48	
MOVANO Combi (J9)	1.9 DTI	1870	59	09.2000	10.2001	F9Q 770	4	G 28	
	1.9 DTI	1870	60	10.2001		F9Q 772/F9Q 774	4	G 28	
	2.2 DTI	2188	66	09.2000		G9T 722/G9T 720/G9T 750	4	G 63	
	2.5 CDTI	2463	73	10.2003	12.2006	G9U 754	4	G 63	
	2.5 CDTI	2464	74	09.2007		G9U 650	4	G 63	
	2.5 CDTI	2464	88	08.2006		G9U 650/G9U 632	4	G 63	
	2.5 CDTI	2464	107	08.2006		G9U 650/G9U 632	4	G 63	
	2.5 DTI	2463	84	10.2001		G9U 754/G9U 750/G9U 724/G9U 720	4	G 63	
	2.5 D	2499	59	07.1998	09.2000	S8U 772/S8U 770	4	G 35	
MOVANO Camionnette (F9)	1.9 DTI	1870	59	09.2000	10.2001	F9Q 770	4	G 28	
	1.9 DTI	1870	60	10.2001		F9Q 772/F9Q 774	4	G 28	
	2.2 DTI	2188	66	09.2000		G9T 722/G9T 720/G9T 750	4	G 63	
	2.5 CDTI	2464	74	08.2006		G9U 650	4	G 63	
	2.5 CDTI	2464	88	08.2006		G9U 650/G9U 632	4	G 63	
	2.5 CDTI	2464	107	10.2003		G9U 650/G9U 632	4	G 63	
	2.5 D	2499	59	01.1999	09.2000	S8U 772/S8U 770	4	G 35	
	2.5 DTI	2463	73	10.2003		G9U 754	4	G 63	
	2.5 DTI	2463	84	10.2001		G9U 754/G9U 724/G9U 720	4	G 63	
MOVANO Kipper (H9)	2.2 DTI	2188	66	09.2000		G9T 722/G9T 720/G9T 750	4	G 63	
	2.5 DTI	2463	84	10.2001		G9U 754/G9U 724/G9U 720	4	G 63	
	2.5 CDTI	2464	74	08.2006		G9U 650	4	G 63	
	2.5 CDTI	2464	88	08.2006		G9U 650/G9U 632	4	G 63	
	2.5 CDTI	2464	107	08.2006		G9U 650/G9U 632	4	G 63	
	2.5 D	2499	59	01.1999	09.2000	S8U 772/S8U 770	4	G 35	
	2.5 DTI	2463	73	10.2003		G9U 754	4	G 63	
MOVANO Camion/Plate-forme (U9, E9)	2.2 DTI	2188	66	09.2000		G9T 722/G9T 720/G9T 750	4	G 63	
	2.5 CDTI	2464	74	08.2006		G9U 650	4	G 63	

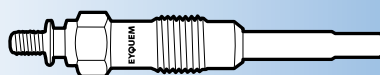



kW



Cyl.



OPEL

	2.5 CDTI	2464	88	08.2006		G9U 650/G9U 632	4	G 63
	2.5 CDTI	2464	107	08.2006		G9U 650/G9U 632	4	G 63
	2.5 D	2499	59	07.1998	09.2000	S8U 772/S8U 770	4	G 35
	2.5 DTi	2463	73	10.2003		G9U 754	4	G 63
	2.5 DTI	2463	84	10.2001		G9U 754/G9U 750/G9U 724/G9U 720	4	G 63
OMEGA A (16_, 17_, 19_)	2.3 D	2260	54	10.1986	03.1994	23 YD	4	G 41
	2.3 TD	2260	66	10.1986	08.1988	23 YDT	4	G 41
	2.3 TD Interc.	2260	74	08.1988	03.1994	23 DTR	4	G 41
OMEGA A Caravan (66_, 67_)	2.3 D	2260	54	09.1986	03.1994	23 YD	4	G 41
	2.3 TD	2260	66	09.1986	08.1988	23 YDT	4	G 41
	2.3 TD Interc.	2260	74	09.1988	03.1994	23 DTR	4	G 41
OMEGA B (25_, 26_, 27_)	2.0 DTI 16V	1995	74	09.1997	09.2000	X 20 DTH	4	G 56
	2.2 DTI 16V	2171	81	09.2000	07.2003	Y 22 DTH	4	G 3
	2.2 DTI 16V	2171	88	09.2000	07.2003	Y 22 DTH	4	G 3
	2.5 DTI	2497	110	09.2001	07.2003	Y 25 DT	6	G 23
	2.5 TD	2497	96	04.1994	07.2003	25 DT/X 25 TD/X 25 DT	6	G 41
OMEGA B Caravan (21_, 22_, 23_)	2.0 DTI 16V	1995	74	09.1997	09.2000	X 20 DTH	4	G 56
	2.2 DTI 16V	2171	81	09.2000	07.2003	Y 22 DTH	4	G 3
	2.2 DTI 16V	2171	88	09.2000	07.2003	Y 22 DTH	4	G 3
	2.5 DTI	2497	110	09.2001	07.2003	Y 25 DT	6	G 23
	2.5 TD	2497	96	04.1994	02.2001	25 DT/X 25 TD/X 25 DT	6	G 41
REKORD E (17_-19_, 11_, 14_, 16_)	2.2 D	2260	52	11.1982	08.1986	23 D	4	G 41
	2.2 TD	2260	63	06.1984	08.1986	23 TD	4	G 41
REKORD E Caravan (61_, 66_, 67_)	2.2 TD	2260	63	06.1984	08.1986	23 TD	4	G 41
	2.3 D	2260	52	11.1982	08.1986	23 D	4	G 41
SENATOR A (29_)	2.2 TD	2260	63	11.1984	08.1987	23 TD	4	G 41
SIGNUM	1.9 CDTI	1910	74	08.2005	09.2008	Z 19 DT chassis n°->71021891	4	G 60
	NEW 1.9 CDTI	1910	74	08.2005		Z 19 DT chassis n°71021892->	4	G 89
	1.9 CDTI	1910	88	04.2004		Z 19 DT chassis n°->71021891	4	G 60
	NEW 1.9 CDTI	1910	88	04.2004		Z 19 DT chassis n°71021892->	4	G 89
	1.9 CDTI	1910	110	04.2004		Z 19 DTH	4	G 8
	2.0 DTI	1994	74	05.2003		Y 20 DTH	4	G 3
	2.2 DTI 16V	2172	86	05.2003	06.2008	Y 22 DTR	4	G 3
	2.2 DTI	2172	92	05.2003		Y 22 DTR	4	G 3
SINTRA	2.2 DTI	2171	85	07.1997	04.1999	X 22 DTH	4	G 56
TIGRA TwinTop	1.3 CDTI	1248	51	06.2004		Z 13 DT	4	G 7
VECTRA A (86_, 87_)	1.7 D	1700	42	10.1988	09.1992	17 D	4	G 41
	1.7 D	1700	44	07.1992	11.1995	17 DR	4	G 41
	1.7 TD	1686	60	03.1990	11.1995	17 DT (TC4EE1)/X 17 DT (TC4EE1) engine n°->731417	4	G 47
	1.7 TD	1686	60	03.1990	11.1995	17 DT (TC4EE1)/X 17 DT (TC4EE1) engine n°731418->	4	G 67
VECTRA A CC (88_, 89_)	1.7 D	1700	42	09.1988	09.1992	17 D	4	G 41
	1.7 D	1700	44	07.1992	11.1995	17 DR	4	G 41
	1.7 TD	1686	60	03.1990	11.1995	17 DT (TC4EE1)/X 17 DT (TC4EE1) engine n°->731417	4	G 47
	1.7 TD	1686	60	03.1990	11.1995	17 DT (TC4EE1)/X 17 DT (TC4EE1) engine n°731418->	4	G 67
VECTRA B (36_)	1.7 TD	1686	60	10.1995	12.1998	X 17 DT (TC4EE1)	4	G 67
	2.0 DI 16V	1995	60	11.1996	07.1999	X 20 DTL chassis n°->V5999999, V1999999,V7999999,VP,VL,VS	4	G 52
	2.0 DI 16V	1995	60	11.1996	04.2002	X 20 DTL chassis n°W5000001, W1000001,W7000001,WP,WS,XL000001	4	G 56
	2.0 DTI 16V	1995	74	06.1997	08.2000	X 20 DTH	4	G 56
	2.0 DTI 16V	1995	74	09.2000	04.2002	Y 20 DTH	4	G 3
	2.2 DTI 16V	2172	88	09.2000	04.2002	Y 22 DTR	4	G 3
	2.2 DTI 16V	2172	92	09.2000	04.2002	Y 22 DTR	4	G 3
VECTRA B Caravan (31_)	1.7 TD	1686	60	11.1996	12.1997	X 17 DT (TC4EE1)	4	G 67
	2.0 DI 16V	1995	60	11.1996	06.2000	X 20 DTL chassis n°->V5999999,V1999999, V7999999,VP,VL,VS	4	G 52
	2.0 DI 16V	1995	60	11.1996	06.2000	X 20 DTL chassis n°W5000001,W1000001, W7000001,WP,WS,XL000001	4	G 56
	2.0 DTI 16V	1995	74	06.1997	08.2000	X 20 DTH	4	G 56
	2.0 DTI 16V	1995	74	09.2000	07.2003	Y 20 DTH	4	G 3
	2.2 DTI 16V	2172	88	09.2000	04.2002	Y 22 DTR	4	G 3





kW



Cyl.



OPEL										
	2.2 DTI 16V	2172	92	09.2000	07.2003		Y 22 DTR	4	G 3	
VECTRA B CC (38_)	1.7 TD	1686	60	10.1995	12.1998		X 17 DT (TC4EE1)	4	G 67	
	2.0 DI 16V	1995	60	11.1996	07.1999		X 20 DTL	4	G 52	
	2.0 DI 16V	1995	60	08.1999	06.2000		X 20 DTL	4	G 56	
	2.0 DTI 16V	1995	74	06.1997	08.2000		Y 20 DTH/X 20 DTH	4	G 56	
	2.0 DTI 16V	1995	74	09.2000	07.2003		Y 20 DTH/X 20 DTH	4	G 3	
	2.2 DTI 16V	2172	88	09.2000	04.2002		Y 22 DTR	4	G 3	
	2.2 DTI 16V	2172	92	09.2000	07.2003		Y 22 DTR	4	G 3	
VECTRA C	1.9 CDTI	1910	74	10.2005			Z 19 DTL chassis n°->48999999, 71021891	4	G 60	
	NEW 1.9 CDTI	1910	74	10.2005			Z 19 DTL chassis n°71021892, 78->	4	G 89	
	1.9 CDTI	1910	88	04.2004			Z 19 DT chassis n°->48999999, 71021891	4	G 60	
	NEW 1.9 CDTI	1910	88	04.2004			Z 19 DT chassis n°71021892, 78->	4	G 89	
	1.9 CDTI	1910	110	04.2004	03.2007		Z 19 DTH	4	G 8	
	2.0 DTI 16V	1995	74	04.2002			Y 20 DTH	4	G 3	
	2.2 DTI 16V	2172	86	04.2002	12.2004		Y 22 DTR	4	G 3	
	2.2 DTI 16V	2172	92	04.2002			Y 22 DTR	4	G 3	
	VECTRA C Caravan	1.9 CDTI	1910	74	10.2005			Z 19 DTL chassis n°->48999999, 71021891	4	G 60
		NEW 1.9 CDTI	1910	74	10.2005			Z 19 DTL chassis n°71021892, 78->	4	G 89
1.9 CDTI		1910	88	04.2004	01.2009		Z 19 DT chassis n°->48999999, 71021891	4	G 60	
NEW 1.9 CDTI		1910	88	04.2004	01.2009		Z 19 DT chassis n°71021892, 78->	4	G 89	
1.9 CDTI		1910	110	04.2004	03.2007		Z 19 DTH	4	G 8	
2.0 DTI		1995	74	10.2003			Y 20 DTH	4	G 3	
2.2 DTI 16V		2172	86	10.2003	06.2008		Y 22 DTR	4	G 3	
2.2 DTI		2172	92	10.2003			Y 22 DTR	4	G 3	
VECTRA C GTS		1.9 CDTI	1910	74	10.2005			Z 19 DTL chassis n°->48999999, 71021891	4	G 60
		NEW 1.9 CDTI	1910	74	10.2005			Z 19 DTL chassis n°71021892, 78->	4	G 89
	1.9 CDTI	1910	88	04.2004	01.2009		Z 19 DT chassis n°->48999999, 71021891	4	G 60	
	NEW 1.9 CDTI	1910	88	04.2004	01.2009		Z 19 DT chassis n°71021892, 78->	4	G 89	
	1.9 CDTI	1910	110	04.2004	03.2007		Z 19 DTH	4	G 8	
	2.0 DTI 16V	1995	74	08.2002			Y 20 DTH	4	G 3	
	2.2 DTI 16V	2172	86	08.2002	06.2008		Y 22 DTR	4	G 3	
	2.2 DTI 16V	2172	92	08.2002			Y 22 DTR	4	G 3	
	VIVARO Combi (J7)	1.9 DI	1870	60	08.2001			F9Q 762/F9Q 774	4	G 28
		1.9 DTI	1870	74	08.2001			F9Q 760	4	G 28
2.5 CDTI		2463	107	08.2006			G9U 630	4	G 63	
2.5 CDTI		2464	84	08.2006			G9U 630	4	G 63	
2.5 DTI		2463	99	05.2003			G9U 630/G9U 730	4	G 63	
VIVARO Camionnette (F7)		1.9 DI	1870	60	08.2001			F9Q 762	4	G 28
		1.9 DTI	1870	74	08.2001			F9Q 760	4	G 28
		2.5 DTI	2463	99	05.2003			G9U 630/G9U 730	4	G 63
		2.5 CDTI	2463	84	08.2006			G9U 630	4	G 63
		2.5 CDTI	2463	107	08.2006			G9MB6/G9U 630	4	G 63
VIVARO Camion/Plate-forme (E7)	1.9 Di	1870	60	08.2001			F9Q 762	4	G 28	
	1.9 DTI	1870	74	08.2006			F9Q 760	4	G 28	
	2.5 CDTI	2464	84	08.2006			G9U 630	4	G 63	
	2.5 DTI	2463	99	08.2003			G9U 730	4	G 63	
	2.5 CDTI	2463	107	08.2006			G9U 630	4	G 63	
VIVARO A Camion/ Plate-forme (X83)	NEW 2.0 CDTI	1995	66	12.2011			M9R 630	4	GPE 93	
	NEW 2.0 CDTI	1995	84	12.2011			M9R 630	4	GPE 93	
VIVARO A Camionnette (X83)	NEW 2.0 CDTI (F7)	1995	66	12.2011			M9R 630	4	GPE 93	
	NEW 2.0 CDTI (F7)	1995	84	12.2011			M9R 692	4	GPE 93	
VIVARO A Combi (X83)	NEW 2.0 CDTI (F7, J7, A07)	1995	84	12.2011			M9R 630 - M9R 692	4	GPE 93	
VIVARO B Camion/ Plate-forme (X82)	NEW 1.6 CDTI (03)	1598	85	06.2014			R9M 408-450	4	GPE 93	
	NEW 1.6 CDTI (03)	1598	88	08.2015			R9M 450	4	GPE 93	
	NEW 1.6 CDTI (03)	1598	92	11.2016			R9M 452	4	GPE 93	
	NEW 1.6 CDTI (03)	1598	103	08.2015			R9M 450	4	GPE 93	
	NEW 1.6 CDTI (03)	1598	107	11.2016			R9M 452	4	GPE 93	
	VIVARO B Camionnette (X82)	NEW 1.6 CDTI (05)	1598	66	06.2014			R9M 408	4	GPE 93
		NEW 1.6 CDTI (05)	1598	70	08.2016			R9M 413	4	GPE 93
		NEW 1.6 CDTI (05)	1598	85	06.2014			R9M 408-450	4	GPE 93
		NEW 1.6 CDTI (05)	1598	88	06.2014			R9M 450	4	GPE 93
		NEW 1.6 CDTI (05)	1598	92	03.2016			R9M 452	4	GPE 93
		NEW 1.6 CDTI (05)	1598	103	06.2014			R9M 450	4	GPE 93

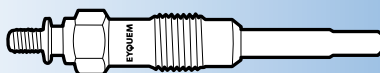



kW



Cyl.



OPEL

	NEW 1.6 CDTi (05)	1598	107	03.2016		R9M 452	4	GPE 93	
VIVARO B Combi (X82)	NEW 1.6 CDTi (06)	1598	66	06.2014		R9M 408	4	GPE 93	
	NEW 1.6 CDTi (06)	1598	70	04.2015		R9M 413	4	GPE 93	
	NEW 1.6 CDTi (06)	1598	85	06.2014		R9M 408-450	4	GPE 93	
	NEW 1.6 CDTi (06)	1598	88	06.2014		R9M 450	4	GPE 93	
	NEW 1.6 CDTi (06)	1598	92	04.2015		R9M 452	4	GPE 93	
	NEW 1.6 CDTi (06)	1598	103	06.2014		R9M 450	4	GPE 93	
ZAFIRA A (F75_)	NEW 1.6 CDTi (06)	1598	107	04.2015		R9M 452	4	GPE 93	
	2.0 DI 16V	1995	60	10.1999	06.2005	X 20 DTL chassis n°->22999999;25,26;28;2B;2H;2G	4	G 56	
	2.0 DI 16V	1995	63	07.1999	06.2000	X 20 DTL chassis n°->22999999;25,26;28;2B;2H;2G	4	G 56	
	2.0 DTI 16V	1995	74	09.2000	06.2005	Y 20 DTH chassis n°->22999999;25,26;28;2B;2H;2G	4	G 56	
	2.0 DTI 16V	1995	74	09.2000	06.2005	Y 20 DTH chassis n°->32000001;35,36;38;3B;3H;4G	4	G 3	
	2.2 DTI 16V	2172	86	01.2000	06.2005	Y 22 DTR chassis n°->32000001;35,36;38;3B;3H;4G	4	G 3	
ZAFIRA B (A05)	2.2 DTI 16V	2172	92	01.2002	06.2005	Y 22 DTR chassis n°->32000001;35,36;38;3B;3H;4G	4	G 3	
	1.7 CDTi	1686	81	01.2008		A 17 DTJ/Z 17 DTJ	4	G 68	
	1.7 CDTi	1686	92	01.2008		A 17 DTR	4	G 68	
	1.9 CDTi	1910	74	07.2005		Z 19 DTL chassis->62999999; 6G999999	4	G 60	
	NEW 1.9 CDTi	1910	74	07.2005		Z 19 DTL chassis n°72000001; 7G000001	4	G 89	
	1.9 CDTi	1910	88	07.2005		Z 19 DT chassis->62999999; 6G999999	4	G 60	
ZAFIRA B Van (A05)	NEW 1.9 CDTi	1910	88	07.2005		Z 19 DT chassis n°72000001; 7G000001	4	G 89	
	1.9 CDTi	1910	110	07.2005		Z 19 DTH	4	G 8	
	1.7 CDTi	1686	81	01.2008		A 17 DTJ/Z 17 DTJ	4	G 68	
	1.7 CDTi	1686	92	01.2008		A 17 DTR	4	G 68	
	ZAFIRA TOURER C (P12)	NEW 1.6 CDTi (75)	1598	88	07.2014		B 16 DTJ	2	GPE 94
		NEW 1.6 CDTi (75)	1598	100	02.2013		B 16 DTH	2	GPE 94
NEW 2.0 CDTi		1956	81	10.2011		A 20 DTL	4	GPE 82	
NEW 2.0 CDTi		1956	96	10.2011		A 20 DT/Y 20 DTJ/Z 20 DTJ	4	GPE 82	
NEW 2.0 CDTi		1956	118	01.2012		A 20 DTH chassis n°->B3999999;B8999999;BG999999	4	GPE 82	
NEW 2.0 CDTi	1956	121	01.2012		A 20 DTH chassis n°->B3999999;B8999999;BG999999	4	GPE 82		

PEUGEOT

1007 (KM_)	1.4 HDi	1398	50	04.2005		8HZ (DV4TD)/8HX (DV4TD)	4	G 72
	1.6 HDi	1560	80	06.2007		9HZ (DV6TED4)	4	G 72
106 I (1A, 1C)	1.4 D	1361	37	09.1992	04.1996	K9Y (TUD3Y)	4	G 35
	1.5 D	1527	40	06.1994	04.1996	VJY (TUD5)	4	G 34
	1.5 D	1527	43	06.1994	04.1996	VJY, VJZ (TUD5)	4	G 34
	1.5 D	1527	40	06.1994	04.1996	VJY (TUD5)	4	G 34
	1.5 D	1527	43	06.1994	04.1996		4	G 34
	1.5 D	1527	40	06.1994	04.1996	VJY (TUD5)	4	G 34
106 II (1)	1.5 D	1527	43	06.1994	04.1996		4	G 34
	1.5 D	1527	40	05.1996		VJY (TUD5)	4	G 34
	1.5 D	1527	42	04.1998		VJX, VJZ (TUD5)	4	G 34
	1.5 D	1527	42	10.2000		VJX (TUD5)	4	G 34
107	1.4 HDi	1398	40	06.2005		8HT (DV4TD)	4	G 72
205 I (741A/C)	1.7 Diesel	1769	44	08.1983	10.1987	161A (XUD7)	4	G 41
205 II (20A/C)	1.7 Diesel	1769	44	07.1987	09.1998	161A (XUD7)	4	G 41
	1.7 Diesel	1769	44	07.1987	09.1998	161A (XUD7)	4	G 41
	1.7 TD	1769	57	01.1990	09.1998	A8B (XUD7TE)	4	G 41
	1.8 XDT	1769	58	08.1990	05.1997	XUD7T	4	G 41
	1.9 Diesel	1905	47	10.1987	09.1998	DJZ (XUD9Y)	4	G 41
	205 Camionnette	1.7 Diesel	1769	44	03.1994		161A (XUD7)	4
1.7 Diesel		1769	44	03.1994		161A (XUD7)	4	G 41
1.8 D		1769	44	02.1983	07.1990	A9A (XUD7)	4	G 41
206 CC (2D)	1.6 HDi 110	1560	80	04.2005		9HZ (DV6TED4)	4	G 72
	1.6 HDi 110	1560	80	04.2005		9HZ (DV6TED4)	4	G 6
206 Hatchback (2A/C)	1.4 HDi eco 70	1398	50	09.2001		8HZ (DV4TD)/8HX (DV4TD)	4	G 72
	1.4 HDi eco 70	1398	50	09.2001		8HZ (DV4TD)/8HX (DV4TD)	4	G 6
	1.6 HDi 110	1560	80	05.2004		9HY (DV6TED4)/9HZ (DV6TED4)	4	G 72
	1.6 HDi 110	1560	80	05.2004		9HY (DV6TED4)/9HZ (DV6TED4)	4	G 6
	1.9 D	1868	51	09.1998	11.2001	WJZ (DW8)/WJY (DW8B)	4	G 34
	2.0 HDi 90	1997	66	12.1999		RHY (DW10TD)	4	G 57
206 Tricorps	1.4 HDi eco 70	1398	50	09.2008		8HZ (DV4TD)	4	G 72
	1.4 HDi eco 70	1398	50	09.2008		8HZ (DV4TD)	4	G 6
206 SW (2E/K)	1.4 HDi	1398	50	07.2002		8HX (DV4TD)	4	G 72
	1.4 HDi	1398	50	07.2002		8HX (DV4TD)	4	G 6

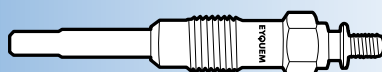



kW



Cyl.



PEUGEOT

	1.6 HDi 110	1560	80	05.2004		9HZ (DV6TED4)	4	G 72
	1.6 HDi 110	1560	80	05.2004		9HZ (DV6TED4)	4	G 6
	2.0 HDi	1997	66	07.2002		RHY (DW10TD)	4	G 57
206 Van	1.4 HDi	1398	50	09.2001	03.2009	8HX, 8HZ (DV4TD)	4	G 72
	1.9 D	1868	51	04.1999	05.2007	WJZ (DW8)/WJY (DW8B)	4	G 34
206+ (T3E)	1.4 HDi eco 70	1398	50	01.2009		8HZ (DV4TD)/8HX (DV4TD)	4	G 72
207 (WA_, WC_)	1.4 HDi	1398	50	02.2006		8HZ (DV4TD)/8HR (DV4TD)	4	G 72
	1.6 HDi	1560	66	02.2006		9HX (DV6ATED4), 9HV (DV6TED4)	4	G 72
	NEW 1.6 HDi	1560	68	11.2009		9HP (DV6DTEd)	4	GPE 81
	1.6 HDi	1560	80	02.2006		9HY (DV6TED4)/9HZ (DV6TED4)	4	G 72
	NEW 1.6 HDi 110	1560	82	08.2009		9HR (DV6C), 9HD (DV6CTED)	4	GPE 81
207 CC (WD_)	1.6 HDi	1560	80	02.2007		9HZ (DV6TED4)	4	G 72
	NEW 1.6 HDi 110	1560	82	08.2009		9HR (DV6C), 9HD (DV6CTED)	4	GPE 81
207 SW (WK_)	1.6 HDi	1560	66	06.2007		9HX (DV6ATED4), 9HV (DV6TED4)	4	G 72
	NEW 1.6 HDi	1560	68	11.2009		9HP (DV6DTEd)	4	GPE 81
	1.6 HDi	1560	80	06.2007		9HZ (DV6TED4)	4	G 72
	NEW 1.6 HDi 110	1560	82	08.2009		9HR (DV6C), 9HD (DV6CTED)	4	GPE 81
207 Van	1.4 HDi	1398	50	04.2007		8HZ (DV4TD)	4	G 72
	1.6 HDi	1560	66	04.2007		9HX (DV6ATED4), 9HV (DV6TED4)	4	G 72
208	NEW 1.4 HDi	1398	50	03.2012		8HR, 8HP (DV4C)	4	GPE 81
	NEW 1.6 BlueHDi 75	1560	55	01.2013		9HK (DV6ETEDM), BHW (DV6FE)	4	GPE 81
	NEW 1.6 HDi	1560	68	03.2012		9HP (DV6DTEd)	4	GPE 81
	NEW 1.6 BlueHDi 100	1560	73	01.2015		BHY (DV6FD)	4	GPE 81
	NEW 1.6 HDi	1560	84	03.2012		9HD (DV6CTED)	4	GPE 81
	NEW 1.6 HDi	1560	85	04.2014		BHX (DV6FC)	4	GPE 81
	NEW 1.6 BlueHDi 120	1560	88	11.2013		BHZ (DV6FC)	4	GPE 81
208 Camionnette	NEW 1.4 HDi	1398	50	10.2012		8HR (DV4C)	4	GPE 81
	NEW 1.6 BlueHDi 75	1560	55	04.2015		BHW (DV6FE)	4	GPE 81
	NEW 1.6 HDi	1560	68	03.2014		9HP (DV6DTEd)	4	GPE 81
2008	NEW 1.4 HDi	1398	50	06.2013		8HR (DV4C)	4	GPE 81
	NEW 1.6 BlueHDi 75	1560	55	01.2015		BHW (DV6FE)	4	GPE 81
	NEW 1.6 BlueHDi 100	1560	73	01.2015		BHY (DV6FD)	4	GPE 81
	NEW 1.6 BlueHDi 120	1560	88	07.2014		BHZ (DV6FC)	4	GPE 81
	NEW 1.6 HDi	1560	68	03.2013		9HP (DV6DTEd)	4	GPE 81
	NEW 1.6 HDi	1560	84	03.2013		9HD (DV6CTED)	4	GPE 81
	NEW 1.6 HDi	1560	85	07.2014		BHX (DV6FC)	4	GPE 81
301	NEW 1.6 HDi 90	1560	68	11.2012		9HF (DV6DTEd)	4	GPE 81
	NEW 1.6 BlueHDi 100	1560	73	04.2014			4	GPE 81
305 I (581A)	1.5 Diesel	1548	36	11.1977	09.1982	149 (XID)	4	G 41
305 I Break (581D)	1.5 Diesel	1548	36	08.1980	09.1982	149 (XID)	4	G 41
305 II (581M)	1.8 D	1769	44	11.1982	12.1988	161A (XUD7)	4	G 41
	1.9 D	1905	47	10.1982	07.1988	D9A (XUD9)/162 (XUD9)	4	G 41
	1.9 D	1905	48	10.1982	07.1988	162 (XUD9)	4	G 41
	1.9 D	1905	47	10.1982	07.1988	D9A (XUD9)/162 (XUD9)	4	G 41
	1.9 D	1905	48	10.1982	07.1988	162 (XUD9)	4	G 41
305 II Break (581E)	1.8 D	1769	44	11.1982	12.1988	161A (XUD7)	4	G 41
	1.9 Diesel	1905	47	10.1982	12.1988	D9A (XUD9)/162 (XUD9)	4	G 41
	1.9 Diesel	1905	48	10.1982	12.1988	162 (XUD9)	4	G 41
306 (7B, N3, N5)	1.9 D	1905	55	03.1998	05.2001	DHV (XUD9BSD)	4	G 41
	1.9 D	1868	51	09.1998	05.2001	WJY (DW8B)/WJZ (DW8)	4	G 34
	1.9 SLD	1905	47	06.1994	05.2001	DJZ (XUD9Y)	4	G 41
	1.9 SLD	1905	50	06.1994	05.2001	DJY (XUD9A)	4	G 41
	1.9 D	1905	55	03.1998	05.2001	DHV (XUD9BSD)	4	G 41
	1.9 SRDT	1905	66	06.1994	05.2001	DHY (XUD9TE), D8A (XUD9TE)	4	G 41
	2.0 HDi 90	1997	66	06.1999	05.2001	RHY (DW10TD)	4	G 57
306 Break (7E, N3, N5)	1.9 D	1905	50	03.1997	04.2002	DJY (XUD9A)	4	G 41
	1.9 D	1905	55	03.1998	04.2002	DHV (XUD9BSD)	4	G 41
	1.9 D	1868	51	09.1998	04.2002	WJY (DW8B)/WJZ (DW8)	4	G 34
	1.9 TD	1905	66	02.1997	04.2002	DHY (XUD9TE), D8A (XUD9TE)	4	G 41
	2.0 HDi 90	1997	66	06.1999	04.2002	RHY (DW10TD)	4	G 57
306 Hatchback (7A, 7C, N3, N5)	1.8 D	1769	43	05.1993	05.2001	A9A (XUD7)	4	G 41
	1.9 D	1868	51	09.1998	05.2001	WJY (DW8B), WJZ (DW8)	4	G 34
	1.9 D	1905	47	05.1993	05.2001	DJZ (XUD9Y)	4	G 41
	1.9 D	1905	50	06.1994	05.2001	DJY (XUD9A)	4	G 41
	1.9 D	1905	51	04.1993	05.1999	XUD9	4	G 41





kW



Cyl.



PEUGEOT

	1.9 D	1905	55	03.1998	05.2001	DHV (XUD9BSD)	4	G 41	
	1.9 DT	1905	66	05.1993	05.2001	DHY (XUD9TE), D8A(XUD9TE)	4	G 41	
307 (3A/C)	2.0 HDi 90	1997	66	06.1999	05.2001	RHY (DW10TD)	4	G 57	
	1.4 HDi	1398	50	10.2001		8HZ (DV4TD)/8HX (DV4TD)	4	G 72	
	1.4 HDi	1398	50	10.2001		8HZ (DV4TD)/8HX (DV4TD)	4	G 6	
	1.6 HDi	1560	66	04.2005		9HX, 9HV (DV6ATED4)	4	G 6	
	1.6 HDi	1560	66	04.2005		9HX, 9HV (DV6ATED4)	4	G 72	
	1.6 HDi 110	1560	80	02.2004		9HY (DV6TED4), 9HZ (DV6TED4)	4	G 72	
	1.6 HDi 110	1560	80	02.2004		9HY (DV6TED4), 9HZ (DV6TED4)	4	G 6	
	2.0 HDi 110	1997	79	08.2000		RHS (DW10ATED)	4	G 57	
307 Break (3E)	2.0 HDi 135	1997	100	10.2003		RHR (DW10BTED4)	4	G 30	
	2.0 HDi 90	1997	66	08.2000		RHY (DW10TD)	4	G 57	
	1.4 HDi	1398	50	03.2002		8HZ (DV4TD)	4	G 72	
	1.4 HDi	1398	50	03.2002		8HZ (DV4TD)	4	G 6	
	1.6 HDi	1560	66	04.2005		9HV (DV6ATED4)	4	G 72	
	1.6 HDi	1560	66	04.2005		9HV (DV6ATED4)	4	G 6	
	1.6 HDi 110	1560	80	02.2004		9HY (DV6TED4), 9HZ (DV6TED4)	4	G 72	
	1.6 HDi 110	1560	80	02.2004		9HY (DV6TED4), 9HZ (DV6TED4)	4	G 6	
	2.0 HDi 110	1997	79	03.2002		RHS (DW10ATED)	4	G 57	
	2.0 HDi 135	1997	100	02.2004		RHR (DW10BTED4)	4	G 30	
307 CC (3B)	2.0 HDi 90	1997	66	03.2002		RHY (DW10TD)	4	G 57	
	2.0 HDi 135	1997	100	06.2005		RHR (DW10BTED4)	4	G 30	
307 SW (3H)	1.4 HDi 70	1398	50	03.2002	01.2005	8HZ (DV4TD)	4	G 6	
	1.6 D	1560	66	12.2006		9HX (DV6ATED4)	4	G 72	
	1.6 D	1560	66	12.2006		9HX (DV6ATED4)	4	G 6	
	1.6 HDi 110	1560	80	02.2004		9HY (DV6TED4), 9HZ (DV6TED4)	4	G 72	
	1.6 HDi 110	1560	80	02.2004		9HY (DV6TED4), 9HZ (DV6TED4)	4	G 6	
	2.0 HDi 110	1997	79	03.2002		RHS (DW10ATED)	4	G 57	
	2.0 HDi 135	1997	100	02.2004		RHR (DW10BTED4)	4	G 30	
	2.0 HDi 90	1997	66	03.2002		RHY (DW10TD)	4	G 57	
	308 (4A_, 4C_)	1.6 HDi	1560	66	09.2007		RHY (DW10TD)	4	G 57
		1.6 HDi	1560	66	09.2007		RHY (DW10TD)	4	G 72
		NEW 1.6 HDi	1560	68	11.2009		9HP (DV6DTEd)	4	GPE 81
		1.6 HDi	1560	80	09.2007		9HZ (DV6TED4)	4	G 72
		NEW 1.6 HDi	1560	82	12.2009		9HR (DV6C)	4	GPE 81
		NEW 1.6 HDi	1560	84	03.2013		9HD (DV6C)	4	GPE 81
2.0 HDi		1997	100	09.2007		RHR (DW10BTED4)	4	G 30	
2.0 HDi		1997	103	07.2010		RHR (DW10BTED4)	4	G 30	
NEW 2.0 HDi		1997	110	10.2011		RHE (DW10CTED4)	4	GPE 81	
NEW 2.0 HDi		1997	120	04.2012		RHH (DW10CTED4)	4	GPE 81	
308 II	NEW 1.6 HDi	1560	68	09.2013		9HP (DV6DTEd)	4	GPE 81	
	NEW 1.6 HDi 100	1560	73	04.2014		BHY (DV6FD)	4	GPE 81	
	NEW 1.6 HDi , BlueHDi 115	1560	85	09.2013		BHZ (DV6FC), 9HC (DV6C)	4	GPE 81	
	NEW 1.6 BlueHDi 120	1560	88	11.2013		BHZ (DV6FC)	4	GPE 81	
	NEW 2.0 BlueHDi 150	1997	110	11.2013		AHX (DW10FD)	4	GPE 81	
	NEW 2.0 GT HDi 180	1997	133	06.2014		AHW (DW10FC)	4	GPE 81	
	NEW 2.0 GT BlueHDi 180	1997	132	06.2017		EHZ (DW10FC)	4	GPE 81	
	308 CC	NEW 1.6 HDi	1560	82	06.2009		9HR (DV6C)	4	GPE 81
		NEW 1.6 HDi	1560	84	03.2013		9HD (DV6C)	4	GPE 81
		2.0 HDi	1997	100	04.2009		RHR (DW10BTED4)	4	G 30
2.0 HDi		1997	103	04.2009		RHF (DW10BTED4)	4	G 30	
NEW 2.0 HDi		1997	120	06.2009		RHH (DW10CTED4)	4	GPE 81	
308 SW		1.6 HDi	1560	66	09.2007		9HX (DV6ATED4), 9HV (DV6ATED4)	4	G 72
	NEW 1.6 HDi	1560	68	11.2009		9HP (DV6DTEd)	4	GPE 81	
	1.6 HDi	1560	80	09.2007		9HZ (DV6TED4)	4	G 72	
	NEW 1.6 HDi	1560	82	12.2009		9HR (DV6C)	4	GPE 81	
	NEW 1.6 HDi	1560	84	03.2013			4	GPE 81	
	2.0 HDi	1997	100	09.2007		RHR (DW10BTED4)	4	G 30	
	2.0 HDi	1997	103	09.2007			4	G 30	
	NEW 2.0 HDi	1997	110	04.2011		RHE (DW10CTED4)	4	GPE 81	
	NEW 2.0 HDi	1997	120	06.2009		RHH (DW10CTED4)	4	GPE 81	
	308 SW II	NEW 1.6 HDi 92	1560	68	03.2014		DV6DTEd	4	GPE 81
NEW 1.6 BlueHDi 100		1560	73	04.2014		BHY (DV6FD)	4	GPE 81	
NEW 1.6 HDi , BlueHDi 115		1560	85	03.2014		BHZ (DV6FC), 9HC (DV6C)	4	GPE 81	
NEW 1.6 BlueHDi 120		1560	88	03.2014		BHZ (DV6FC)	4	GPE 81	
NEW 2.0 BlueHDi 150		1997	110	03.2014		DW10CTED4	4	GPE 81	

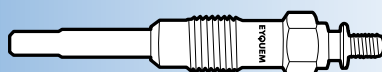



kW



Cyl.



PEUGEOT

3008 Monospace (OU_)	NEW 2.0 GT BlueHdi 180	1997	133	06.2014		AHW (DW10FC)	4	GPE 81
	1.6 Hdi	1560	80	06.2009		9HZ (DV6TED4)	4	G 72
	NEW 1.6 Hdi	1560	82	08.2010		9HR (DV6C)	4	GPE 81
	NEW 1.6 Hdi	1560	84	03.2013		9HD (DV6CTED)	4	GPE 81
	NEW 1.6 BlueHdi 120	1560	88	05.2014		BHZ (DV6FC)	4	GPE 81
	NEW 2.0 Hdi	1997	100	09.2011		RHD (DW10CB)	4	GPE 81
	NEW 2.0 Hdi 150 / BlueHdi 150	1997	110	06.2009		RHE (DW10CTED4), AHX (DW10FD)	4	GPE 81
	NEW 2.0 Hdi	1997	120	06.2009		RHH (DW10CTED4)	4	GPE 81
	NEW 2.0 Hdi Hybrid4	1997	120	02.2011		RHH (DW10CTED4)	4	GPE 81
	NEW 2.0 Hdi Hybrid4	1997	147	11.2011		DW10CTED4	4	GPE 81
3008 SUV (M_)	NEW 1.6 BlueHdi 100	1560	73	11.2016		BHY (DV6FD)	4	GPE 81
	NEW 1.6 BlueHdi 120	1560	88	05.2016		BHZ (DV6FC)	4	GPE 81
	NEW 2.0 BlueHdi 136	1997	100	11.2016		AHV (DW10FD)	4	GPE 81
	NEW 2.0 BlueHdi 150	1997	110	05.2016		AHX (DW10FD)	4	GPE 81
	NEW 2.0 BlueHdi 180	1997	133	05.2016		AHW (DW10FC)	4	GPE 81
309 I (10C, 10A)	1.9 D	1905	47	06.1986	07.1989	D9A (XUD9), 162 (XUD9)	4	G 41
309 II (3C, 3A)	1.8 Diesel	1769	44	07.1989	12.1993	161A (XUD7)	4	G 41
	1.8 TD	1769	57	08.1989	12.1993	A8B (XUD7TE)	4	G 41
405 I (15B)	1.9 Diesel	1905	47	07.1989	12.1993	D9A (XUD9), DJZ (XUD9Y), 162 (XUD9)	4	G 41
	1.8 Turbo Diesel	1769	66	03.1988	12.1992	A8A (XUD7TE), AJZ (XUD7TEY)	4	G 41
	1.9 Diesel	1905	47	07.1988	09.1992	DJZ (XUD9Y)	4	G 41
405 I Break (15E)	1.9 Diesel	1905	51	03.1988	12.1992	D9B (XUD9A)	4	G 41
	1.8 GLD	1769	44	04.1990	07.1992		4	G 41
	1.8 TD	1769	66	10.1988	08.1992	A8A (XUD7TE), AJZ (XUD7TEY)	4	G 41
	1.9 D	1905	47	10.1988	08.1992	DJZ (XUD9Y)	4	G 41
405 II (4B)	1.9 D	1905	51	10.1988	08.1992	DJY (XUD9A), D9B (XUD9A)	4	G 41
	1.9 D	1905	47	08.1992	10.1995	DJZ (XUD9Y)	4	G 41
	1.9 D	1905	50	06.1994	10.1995	DJY (XUD9A)	4	G 41
405 II Break (4E)	1.9 TD	1905	66	08.1992	10.1995	DHY (XUD9TE)	4	G 41
	1.9 D	1905	47	08.1992	10.1996	DJZ (XUD9Y)	4	G 41
	1.9 D	1905	50	06.1994	10.1996	DJY (XUD9A)	4	G 41
	1.9 D	1905	51	09.1993	12.1995	XUD9	4	G 41
406 (8B)	1.9 TD	1905	66	08.1992	10.1996	DHY (XUD9TE)	4	G 41
	1.9 D	1905	55	10.1996	05.2004	DHW (XUD9SD)	4	G 41
	1.9 TD	1905	66	01.1996	05.2004	DHX (XUD9TE)	4	G 41
	1.9 TD	1905	68	01.1996	05.2004	DHY (XUD9TE)	4	G 41
	2.0 Hdi 110	1997	80	06.1998	08.2001	RHZ (DW10ATED)	4	G 57
	2.0 Hdi 110	1997	79	08.2001	05.2004	RHZ (DW10ATED)/RHS (DW10ATED)	4	G 57
	2.0 Hdi 90	1997	66	02.1999	05.2004	RHY (DW10TD)	4	G 57
	2.1 TD 12V	2088	80	01.1996	05.2004	P8C (XUD11BTE)	4	G 41
	2.2 Hdi	2179	98	03.2000	05.2004	4HX (DW12TED4/FAP)	4	G 57
	2.2 Hdi	2179	98	03.2000	05.2004	4HX (DW12TED4/FAP)	4	G 30
406 Break (8E/F)	1.9 D	1905	55	10.1996	10.2004	DHW (XUD9SD)	4	G 41
	1.9 TD	1905	66	10.1996	10.2004	DHX (XUD9TE)	4	G 41
	2.0 Hdi 110	1997	80	02.1999	04.2004	RHZ (DW10ATED)	4	G 57
	2.0 Hdi 110	1997	79	08.2001	10.2004	RHZ (DW10ATED), RHS (DW10ATED)	4	G 57
	2.0 Hdi 90	1997	66	02.1999	10.2004	RHY (DW10TD)	4	G 57
	2.1 TD 12V	2088	80	10.1996	10.2004	P8C (XUD11BTE)	4	G 41
	2.2 Hdi	2179	98	03.2000	10.2004	4HX (DW12TED4/FAP)	4	G 57
	2.2 Hdi	2179	98	03.2000	10.2004	4HX (DW12TED4/FAP)	4	G 30
	2.2 Hdi	2179	98	03.2000	12.2004	4HX (DW12TED4/FAP)	4	G 57
	2.2 Hdi	2179	98	03.2000	12.2004	4HX (DW12TED4/FAP)	4	G 30
407 (6D_)	1.6 Hdi 110	1560	80	03.2006		9HZ (DV6TED4)	4	G 72
	1.6 Hdi 110	1560	80	05.2004	02.2006	9HZ (DV6TED4)	4	G 6
	2.0 Hdi 135	1997	100	05.2004		RHR (DW10BTED4)	4	G 30
	2.0 Hdi	1997	103	08.2008		RHF (DW10BTED4)	4	G 30
	NEW 2.0 Hdi	1997	110	02.2010		RHE (DW10CTED4)	4	GPE 81
	NEW 2.0 Hdi	1997	120	07.2009		RHH (DW10CTED4)	4	GPE 81
	NEW 2.2 Hdi	2179	120	06.2008		4HP (DW12BTED4)	4	G 88
	NEW 2.2 Hdi 170	2179	125	05.2006		4HT (DW12BTED4)	4	G 88
	2.7 Hdi	2720	150	10.2005		UHZ (DT17)	6	G 5
	407 Coupe (6C_)	2.0 Hdi	1997	100	10.2005		RHR (DW10BTED4)	4
407 Coupe (6C_)	NEW 2.0 Hdi	1997	110	02.2010		RHE (DW10CTED4)	4	GPE 81
	NEW 2.0 Hdi	1997	120	06.2009		RHH (DW10CTED4)	4	GPE 81
	2.7 Hdi	2720	150	10.2005		UHZ (DT17)	6	G 5





kW



Cyl.



PEUGEOT

407 SW (6E_)	1.6 HDi 110	1560	80	03.2006		9HZ (DV6TED4)	4	G 72	
	1.6 HDi 110	1560	80	05.2004	02.2006	9HZ (DV6TED4)	4	G 6	
	2.0 HDi 135	1997	100	05.2004		RHR (DW10BTED4)	4	G 30	
	2.0 HDi	1997	103	08.2008		RHR (DW10BTED4)	4	G 30	
	NEW 2.0 HDi	1997	110	02.2010		RHE (DW10CTED4)	4	GPE 81	
	NEW 2.0 HDi	1997	120	07.2009		RHH (DW10CTED4)	4	GPE 81	
	NEW 2.2 HDi	2179	120	06.2008		4HP (DW12BTED4)	4	G 88	
4007 (GP_)	NEW 2.2 HDi	2179	115	02.2007		4HN/4HK (DW12MTED4)	4	G 88	
	4008	NEW 1.6 HDi	1560	84	05.2012		DV6	4	GPE 81
		NEW 1.6 HDi AWC	1560	84	05.2012		9HD (DV6C)	4	GPE 81
504 (A_, M_)	1.9 D (M20)	1948	40	03.1973	07.1986	XD4x88	4	G 41	
	2.1 D	2112	43	09.1979	08.1982	XD90	4	G 41	
	2.1 D (A20, M20)	2112	48	02.1971	07.1986	XD4x90	4	G 41	
	2.1 D	2112	49	09.1979	08.1982		4	G 41	
	2.3 D (A40, A45)	2304	51	07.1975	12.1983	134 (XD2)	4	G 41	
504 Break (D_, F_)	2.1 D (E20, F20)	2112	48	04.1971	07.1986	XD4x90	4	G 41	
	2.3 D (D40, F40)	2304	51	07.1975	07.1986	134 (XD2)	4	G 41	
504 Pick-up (E_)	1.9 D	1948	40	01.1980	12.1989	XD4x88	4	G 41	
	1.9 D	1948	41	08.1981	10.1986		4	G 41	
	2.3 D	2304	51	01.1980	12.1989	134 (XD2)	4	G 41	
505 (551A)	2.3 Turbo Diesel	2304	59	09.1980	06.1986	147 (XD2S)	4	G 41	
	2.5 Diesel	2498	51	10.1981	11.1990	155 (XD3)	4	G 41	
	2.5 Diesel	2498	55	06.1981	12.1993	155 (XD3)	4	G 41	
	2.5 Turbo Diesel	2498	66	10.1983	12.1993	152A (XD3T)	4	G 41	
	2.5 Turbo Diesel	2498	70	10.1983	12.1990	XD3T	4	G 41	
	2.5 Turbo Diesel	2498	77	10.1986	12.1993	152B (XD3TE)	4	G 41	
505 Break (551D)	2.3 Diesel	2304	59	04.1982	06.1986	147 (XD2S)	4	G 41	
	2.5 Diesel	2498	51	01.1986	12.1993	155 (XD3)	4	G 41	
	2.5 Diesel	2498	55	08.1983	12.1993	155 (XD3)	4	G 41	
	2.5 Turbo Diesel	2498	66	10.1985	11.1987	152A (XD3T)	4	G 41	
	2.5 Turbo Diesel	2498	77	10.1986	12.1993	152B (XD3TE)	4	G 41	
508	NEW 1.6 HDi	1560	82	11.2010		9HR-9HL (DV6C)	4	GPE 81	
	NEW 1.6 HDi	1560	84	02.2012		9HD (DV6CTED)	4	GPE 81	
	NEW 1.6 HDi	1560	85	09.2014		BHX (DV6FC)	4	GPE 81	
	NEW 1.6 BlueHDi 120	1560	88	03.2014		BHZ (DV6FC)	4	GPE 81	
	NEW 2.0 HDi	1997	100	11.2010		RHR (DW10BTED4)	4	G 30	
	2.0 HDi	1997	103	11.2010		RHF (DW10BTED4)	4	G 30	
	NEW 2.0 BlueHDi 150	1997	110	04.2014		AHX (DW10FD)	4	GPE 81	
	NEW 2.0 BlueHDi 180	1997	133	04.2014		AHW (DW10FC)	4	GPE 81	
	NEW 2.0 HDi	1997	120	11.2010		RHH (DW10CTED4)	4	GPE 81	
	NEW 2.0 HDi Hybrid4 AWC	1997	120	11.2010		RHC (DW10CTED4)	4	GPE 81	
	NEW 2.0 HDi Hybrid4 AWC	1997	147	11.2010		RHC (DW10CTED4)	4	GPE 81	
508 SW	NEW 1.6 HDi	1560	82	11.2010		9HR (DV6C)	4	GPE 81	
	NEW 1.6 HDi	1560	84	02.2012		9HD (DV6CTED)	4	GPE 81	
	NEW 1.6 HDi	1560	85	09.2014		BHX (DV6FC)	4	GPE 81	
	NEW 1.6 BlueHDi 120	1560	88	03.2014		BHZ (DV6FC)	4	GPE 81	
	NEW 2.0 BlueHDi 150	1997	110	04.2014		AHX (DW10FD)	4	GPE 81	
	NEW 2.0 BlueHDi 180	1997	133	04.2014		AHW (DW10FC)	4	GPE 81	
	2.0 HDi	1997	100	11.2010		RHR (DW10BTED4)	4	G 30	
	2.0 HDi	1997	103	11.2010		RHR (DW10BTED4)	4	G 30	
	NEW 2.0 HDi	1997	120	11.2010		RHH (DW10CTED4)	4	GPE 81	
	NEW 2.0 HDi RXH Hybrid4	1997	120	11.2010		RHC (DW10CTED4)	4	GPE 81	
	NEW 2.0 HDi RXH Hybrid4	1997	147	12.2011		RHC (DW10CTED4)	4	GPE 81	
5008	1.6 HDi	1560	80	09.2009		9HZ (DV6TED4)	4	G 72	
	NEW 1.6 HDi	1560	82	08.2010		9HR (DV6C)	4	GPE 81	
	NEW 1.6 HDi	1560	84	03.2013		9HD (DV6CTED)	4	GPE 81	
	NEW 1.6 BlueHDi 120	1560	88	05.2014		BHZ (DV6FC)	4	GPE 81	
	NEW 2.0 HDi 136 / BlueHDi 136	1997	100	02.2012		RHD (DW10CTED4), AHV (DW10FD)	4	GPE 81	
	NEW 2.0 HDi 150 / BlueHDi 150	1997	110	06.2009		RHE (DW10CTED4), AHX, AHR (DW10FD)	4	GPE 81	
	NEW 2.0 HDi	1997	120	09.2009		RHH (DW10CTED4)	4	GPE 81	
5008 II	NEW 1.6 BlueHDi 100	1560	73	12.2016		BHY (DV6FD)	4	GPE 81	
	NEW 1.6 BlueHDi 115	1560	85	12.2016		BHX (DV6FC)	4	GPE 81	
	NEW 1.6 BlueHDi 120	1560	88	12.2016		BHZ (DV6FC)	4	GPE 81	

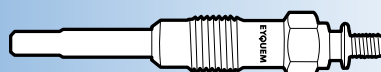



kW



Cyl.



PEUGEOT

	NEW	2.0 BlueHDi 136	1997	100	12.2016		AHV (DW10FD)	4	GPE 81
	NEW	2.0 BlueHDi 150	1997	110	12.2016		AHX (DW10FD)	4	GPE 81
	NEW	2.0 BlueHDi 180	1997	130	01.2018		EHZ (DW10FC)	4	GPE 81
	NEW	2.0 BlueHDi 180	1997	133	12.2016		AHW (DW10FC)	4	GPE 81
604 (561A_)		2.3 TD	2304	59	09.1979	05.1983	147 (XD2S)	4	G 41
		2.5 TD	2498	66	08.1983	12.1986	152A (XD3T)	4	G 41
605 (6B)		2.1 D	2138	60	06.1989	07.1995	P9A (XUD11A)	4	G 41
		2.1 TD 12V	2088	80	08.1994	09.1999	P8C (XUD11BTE)	4	G 41
		2.1 Turbo Diesel	2088	80	06.1989	09.1999	PHZ (XUD11ATE)	4	G 41
		2.5 Turbo Diesel	2446	95	07.1994	09.1999	THY (DK5ATE)	4	G 41
607 (9D, 9U)		2.0 HDi	1997	79	03.2001	07.2004	RHS (DW10ATED)	4	G 57
		2.0 HDi	1997	80	05.2000		RHZ (DW10ATED)	4	G 57
		2.0 HDi	1997	100	09.2005		RHR (DW10BTED4)	4	G 30
		2.2 HDi	2179	98	02.2000		4HX (DW12TED4/FAP)	4	G 57
		2.2 HDi	2179	98	02.2000		4HX (DW12TED4/FAP)	4	G 30
	NEW	2.2 HDi	2179	125	05.2006	06.2010	4HT (DW12BTED4)	4	G 88
		2.7 HDi 24V	2721	150	12.2004		DT17TED4	6	G 5
806 (221)		1.9 TD	1905	66	07.1995	08.2002	DHX (XUD9TE)	4	G 41
		1.9 TD	1905	68	05.1997	08.2002	DHY (XUD9TE)	4	G 41
		2.0 HDi	1997	80	08.1999	08.2002	RHZ (DW10ATED)	4	G 57
		2.0 HDi 16V	1997	80	08.1999	08.2002	RHW (DW10ATED4)	4	G 57
		2.1 td 12V	2088	80	06.1996	08.1999	P8C (XUD11BTE)	4	G 41
807 (E)		2.0 HDi	1997	79	06.2002		RHK (DW10UTED4)/RHT (DW10ATED4)/ RHM (DW10ATED4)/RHW (DW10ATED4)	4	G 57
		2.0 HDi	1997	79	06.2002		RHK (DW10UTED4)/RHT (DW10ATED4)/ RHM (DW10ATED4)/RHW (DW10ATED4)	4	G 30
		2.0 HDi	1997	80	04.2004	05.2006	RHW (DW10ATED4)	4	G 57
		2.0 HDi	1997	80	04.2004	05.2006	RHW (DW10ATED4)	4	G 30
		2.0 HDi	1997	88	11.2006		RHK (DW10UTED4)	4	G 30
		2.0 HDi	1997	100	06.2006		RHR (DW10BTED4)	4	G 30
	NEW	2.0 HDi	1997	120	06.2009		RHH (DW10CTED4)	4	GPE 81
		2.2 HDi	2179	94	06.2002		4HX (DW12TED4/FAP)	4	G 57
		2.2 HDi	2179	94	06.2002		4HX (DW12TED4/FAP)	4	G 30
	NEW	2.2 HDi	2179	125	06.2006		4HT (DW12BTED4)	4	G 88
BIPPER (AA_)	NEW	1.3 HDi 75	1248	55	10.2010		199 A9.000, FHZ (F13DTE5)	4	GPE 80
		1.4 HDi	1398	50	02.2008		8HS (DV4TED)	4	G 72
BIPPER Tepee	NEW	1.3 HDi 75	1248	55	10.2010		199 A9.000, FHZ (F13DTE5)	4	GPE 80
		1.4 HDi	1398	50	04.2008		8HS (DV4TED)	4	G 72
RCZ	NEW	2.0 HDi	1997	120	03.2010		RHH (DW10CTED4)	4	GPE 81
BOXER Bus	NEW	2.0 BlueHDi 110	1997	81	07.2015		AHM (DW10FUJ)	4	GPE 81
	NEW	2.0 BlueHDi 130	1997	96	07.2015		AHN (DW10FUD)	4	GPE 81
	NEW	2.0 BlueHDi 160	1997	120	07.2015		AHP (DW10FUC)	4	GPE 81
		2.2 HDi 100	2198	74	04.2006		4HV (P22DTE)	4	G 65
	NEW	2.2 HDi 110	2198	81	03.2011		4HG (P22DTE)	4	GPE 92
		2.2 HDi 120	2198	88	04.2006		4HU (P22DTE)	4	G 65
	NEW	2.2 HDi 130	2198	96	03.2011		4HH (P22DTE)	4	GPE 92
	NEW	2.2 HDi 150	2198	110	03.2011		4HJ (P22DTE)	4	GPE 92
		3.0 HDi 145	2999	107	04.2010			4	G 9
		3.0 HDi 160	2999	116	04.2006		F1CE0481D (F30DT)	4	G 9
		3.0 HDi 175	2999	130	03.2011		F1CE0481D (F30DT)	4	G 9
BOXER Bus (230P)		1.9 D	1905	51	03.1994	04.2002	D9B (XUD9AU)	4	G 41
		1.9 D	1905	51	03.1994	04.2002	D8C (XUD9AU)	4	G 41
		1.9 TD	1905	66	08.1994	04.2002	DHY (XUD9TE)	4	G 41
		1.9 TD	1905	68	03.1994	04.2002	D8C (XUD9UTF)	4	G 41
		1.9 TD 4x4	1905	68	07.1996	04.2002	D8C (XUD9UTF)	4	G 41
		2.5 D	2446	63	08.1994	04.2002	T9A (DJ5)	4	G 41
		2.5 D 4x4	2446	63	07.1996	04.2002	T9A (DJ5)	4	G 41
		2.5 TD	2446	76	07.1994	04.2002	T8A (DJ5T)	4	G 41
		2.5 TD 4x4	2446	76	07.1996	04.2002	T8A (DJ5T)	4	G 41
		2.5 TDI	2446	79	01.1997	04.2002	THX (DJ5TED)	4	G 55
		2.5 TDI 4x4	2446	79	01.1997	04.2002	THX (DJ5TED)	4	G 55
		2.8 D	2798	64	01.1999	02.2002	8140.63 (F28D)	4	G 62
		2.8 HDi	2798	93	10.2000	11.2001	8140.43S (F28DTCR)	4	G 62
		2.8 HDi	2798	94	11.2000	04.2002	8140.43S (F28DTCR)	4	G 62
BOXER Bus (244, Z_)		2.0 HDi	1997	62	04.2002		RHV (DW10TD)/RHW (DW10UTD)	4	G 57

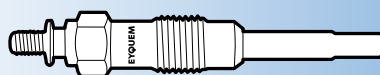



kW



Cyl.



PEUGEOT

	2.2 HDi	2179	74	05.2003		4HY (DW12UTED)	4	G 30
	2.2 HDi	2179	74	04.2002	04.2003	4HY (DW12UTED)	4	G 57
	2.8 HDi 4x4	2798	94	04.2002		8140.43S (F28DTCR)	4	G 62
	2.8 HDi	2798	107	04.2004		8140.43N	4	G 62
BOXER Camionnette	2.2 HDi 100	2198	74	04.2006		4HV (P22DTE)	4	G 65
	NEW 2.2 HDi 110	2198	81	03.2011		4HG (P22DTE)	4	GPE 92
	2.2 HDi 120	2198	88	04.2006		4HU (P22DTE)	4	G 65
	NEW 2.2 HDi 130	2198	96	03.2011		4HH (P22DTE)	4	GPE 92
	NEW 2.2 HDi 150	2198	110	03.2011		4HJ (P22DTE)	4	GPE 92
	3.0 HDi	2998	115	07.2006		F1CE0481D (F30DT)	4	G 9
	3.0 HDi 145	2999	116	04.2010			4	G 9
	3.0 HDi 160	2999	116	04.2006		F1CE0481D (F30DT)	4	G 9
	3.0 HDi 175	2999	130	03.2011		F1CE0481D (F30DT)	4	G 9
BOXER Camionnette (230L)	1.9 D	1905	50	07.1999	04.2002	DJY (XUD9A)	4	G 41
	1.9 D	1905	51	03.1994	04.2002	D9B (XUD9AU)	4	G 41
	1.9 DT 4x4	1905	66	03.1996	09.1998	XUD9TE	4	G 41
	1.9 TD	1905	66	07.1999	04.2002	XUD9TE	4	G 41
	1.9 TD	1905	68	03.1994	04.2002	D8C (XUD9UTF)	4	G 41
	2.0 HDi	1997	62	08.2001	04.2002	RHV (DW10UTD)	4	G 57
	2.5 D	2446	63	03.1994	04.2002	T9A (DJ5)	4	G 41
	2.5 D 4x4	2446	63	07.1999	04.2002	T9A (DJ5)	4	G 41
	2.5 TD	2446	76	03.1994	04.2002	T8A (DJ5T)	4	G 41
	2.5 TDI	2446	79	01.1997	04.2002	THX (DJ5TED)	4	G 55
	2.5 TDI 4x4	2446	79	07.1999	04.2002	THX (DJ5TED)	4	G 55
	2.8 D	2798	64	01.1999	02.2002	8140.63 (F28D)	4	G 62
	2.8 HDi	2798	94	10.2000	11.2001	8140.43S (F28DTCR)	4	G 62
	2.8 HDi 4x4	2798	94	11.2000	04.2002	8140.43S (F28DTCR)	4	G 62
BOXER Camionnette (244)	2.0 HDi	1997	62	04.2002	04.2003	RHV (DW10TD)/RHV (DW10UTD)	4	G 57
	2.2 HDi	2179	74	05.2003		4HY (DW12UTED)	4	G 30
	2.2 HDi	2179	74	04.2002	04.2003	4HY (DW12UTED)	4	G 57
	2.8 HDi 4x4	2798	94	04.2002		8140.43S (F28DTCR)	4	G 62
	2.8 HDi	2798	107	04.2004		8140.43N	4	G 62
BOXER Camion/Plate-forme	2.2 HDi 100	2198	74	04.2006		4HV (P22DTE)	4	G 65
	NEW 2.2 HDi 110	2198	81	03.2011		4HG (P22DTE)	4	GPE 92
	2.2 HDi 120	2198	88	04.2006		4HU (P22DTE)	4	G 65
	NEW 2.2 HDi 130	2198	96	03.2011		4HH (P22DTE)	4	GPE 92
	NEW 2.2 HDi 150	2198	110	03.2011		4HJ (P22DTE)	4	GPE 92
	3.0 HDi	2998	115	02.2007		F1CE0481D (F30DT)	4	G 9
	3.0 HDi 145	2999	116	04.2010			4	G 9
	3.0 HDi 160	2999	116	04.2006		F1CE0481D (F30DT)	4	G 9
	3.0 HDi 175	2999	130	03.2011		F1CE0481D (F30DT)	4	G 9
BOXER Camion/Plate-forme (244)	2.0 HDi	1997	62	04.2002		RHV (DW10TD)/RHV (DW10UTD)	4	G 57
	2.2 HDi	2179	74	05.2003		4HY (DW12UTED)	4	G 30
	2.2 HDi	2179	74	04.2002	04.2003	4HY (DW12UTED)	4	G 57
	2.8 HDi 4x4	2798	94	04.2002		8140.43S (F28DTCR)	4	G 62
	2.8 HDi	2798	107	04.2004		8140.43N	4	G 62
BOXER Camion/Plate-forme (ZCT_)	1.9 TD	1905	66	12.1998	04.2002	DHY (XUD9TE)	4	G 41
	1.9 TD	1905	68	07.1996	04.2002	D8C (XUD9UTF), XUD9TE	4	G 41
	2.5 D	2446	63	03.1994	04.2002	T9A (DJ5)	4	G 41
	2.5 D 4x4	2446	63	07.1999	04.2002	T9A (DJ5)	4	G 41
	2.5 TD	2446	76	03.1994	04.2002	T8A (DJ5T)	4	G 41
	2.5 TDI	2446	79	01.1997	04.2002	THX (DJ5TED)	4	G 55
	2.5 TDI 4x4	2446	79	07.1999	04.2002	THX (DJ5TED)	4	G 55
	2.8 D	2798	64	01.1999	02.2002	8140.63 (F28D)	4	G 62
	2.8 HDi 4x4	2798	93	10.2000	11.2001	8140.43S (F28DTCR)	4	G 62
	2.8 HDi	2798	107	11.2000	04.2002	8140.43S (F28DTCR)	4	G 62
EXPERT (224)	1.9 D	1905	51	12.2003		WJY (DW8B)/WJZ (DW8)	4	G 41
	1.9 D	1905	51	02.1996		D9B (XUD9AU)	4	G 41
	1.9 TD	1905	66	02.1996		DHX (XUD9TE)	4	G 41
	1.9 TD	1905	68	02.1996		D8B (XUD9TE)	4	G 41
	2.0 HDi	1997	69	10.2002	11.2003	RHX (DW10BTED)	4	G 57
	2.0 HDi	1997	80	07.2000		RHZ (DW10ATED, DW10BTED, DW10CTED)	4	G 57
	2.0 HDi	1997	80	07.2000		RHW (DW10ATED4)	4	G 57
	2.0 HDi	1997	80	07.2000		RHW (DW10ATED4)	4	G 30
EXPERT Autobus	NEW 1.6 BlueHDi 95	1560	70	04.2016		BHV-BHS (DV6FDU)	4	GPE 81

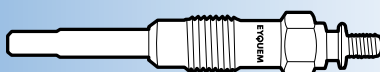



kW



Cyl.



PEUGEOT

	NEW	1.6 BlueHDi 115	1560	85	04.2016		BHX (DV6FCU)	4	GPE 81
	NEW	2.0 BlueHDi 150	1997	110	04.2016		AHX (DW10FD)	4	GPE 81
EXPERT Camionnette	NEW	1.6 BlueHDi 95	1560	70	04.2016		BHV (DV6FDU)	4	GPE 81
	NEW	1.6 BlueHDi 115	1560	85	04.2016		BHX (DV6FC)	4	GPE 81
	NEW	2.0 BlueHDi 120	1997	90	04.2016		AHJ (DW10FE)	4	GPE 81
	NEW	2.0 BlueHDi 150	1997	110	04.2016		AHX (DW10FD)	4	GPE 81
	NEW	2.0 BlueHDi 180	1997	130	04.2016		AHH (DW10FC)	4	GPE 81
EXPERT Camionnette (222)		1.9 D	1905	51	02.1996		D9B (XUD9AU)	4	G 41
		1.9 D 70	1868	51	12.1998		WJY (DW8B)/WJZ (DW8)	4	G 34
		1.9 TD	1905	66	02.1996		DHX (XUD9TE)	4	G 41
		1.9 TD	1905	68	02.1996		D8B (XUD9TE)	4	G 41
		1.9 TD	1905	66	02.1996		DHX (XUD9TE)	4	G 41
		1.9 TD	1905	68	02.1996		D8B (XUD9TE)	4	G 41
		2.0 HDi	1997	69	07.2000		RHX (DW10BTD)	4	G 57
		2.0 HDi	1997	80	07.2000		RHZ (DW10ATED, DW10BTD, DW10CTED)	4	G 57
		2.0 HDi	1997	80	07.2000		RHW (DW10ATED4)	4	G 57
		2.0 HDi	1997	80	07.2000		RHW (DW10ATED4)	4	G 30
EXPERT Camionnette (VF3A_, VF3U_, VF3X_)		1.6 HDi 90	1560	66	01.2007		9HU (DV6UTED4)	4	G 72
	NEW	1.6 HDi 90 8V	1560	66	12.2010		9HM (DV6UC), 9HH (DV6DUM)	4	GPE 81
	NEW	2.0 HDi 100	1997	72	03.2011			4	GPE 81
		2.0 HDi 120	1997	88	01.2007		RHK (DW10UTED4)	4	G 30
	NEW	2.0 HDi 130	1997	94	03.2011		AHZ (DW10CD)	4	GPE 81
		2.0 HDi 140	1997	100	01.2007		RHR (DW10BTD4)	4	G 30
	NEW	2.0 HDi 165	1997	120	09.2009		RHH (DW10CTED4)	4	GPE 81
EXPERT Camion/Plate-forme		1.6 HDi 90	1560	66	01.2007		9HU (DV6UTED4)	4	G 72
		2.0 HDi 120	1997	88	01.2007		RHK (DW10UTED4)	4	G 30
	NEW	2.0 HDi 130	1997	94	07.2011		AHZ (DW10CD)	4	GPE 81
		2.0 HDi 140	1997	100	01.2007		RHR (DW10BTD4)	4	G 30
	NEW	2.0 HDi 165	1997	120	04.2010		RHH (DW10CTED4)	4	GPE 81
EXPERT Camion/ Plate-forme	NEW	1.6 BlueHDi 95	1560	70	09.2016		BHV (DV6FDU)	4	GPE 81
	NEW	2.0 BlueHDi 120	1997	90	09.2016			4	GPE 81
	NEW	2.0 BlueHDi 150	1997	110	09.2016		AHX (DW10FD)	4	GPE 81
EXPERT Camion/Plate-forme (223)		1.9 D	1905	51	02.1996		WJY (DW8B)/WJZ (DW8)	4	G 34
		1.9 D	1905	51	02.1996		D9B (XUD9AU)	4	G 41
		1.9 TD	1905	66	02.1996		DHX (XUD9TE)	4	G 41
		1.9 TD	1905	68	02.1996		D8B (XUD9TE)	4	G 41
		2.0 HDi	1997	80	10.2000	10.2006	RHW (DW10ATED4)	4	G 57
		2.0 HDi	1997	80	10.2000	10.2006	RHW (DW10ATED4)	4	G 30
EXPERT Tepee (VF3V_)	NEW	1.6 HDi 90 8V	1560	66	12.2010		9HM (DV6UC), 9HH (DV6DUM)	4	GPE 81
		1.6 HDi 90 16V	1560	66	01.2007		9HU (DV6UTED4)	4	G 72
	NEW	2.0 HDi 100	1997	72	03.2011		AHY (DW10CE)	4	GPE 81
		2.0 HDi 120	1997	88	01.2007		RHK (DW10UTED4)	4	G 30
	NEW	2.0 HDi 130	1997	94	03.2011		AHZ (DW10CD)	4	GPE 81
		2.0 HDi 140	1997	100	01.2007		RHR (DW10BTD4)	4	G 30
	NEW	2.0 HDi 165	1997	120	09.2009		RHH (DW10CTED4)	4	GPE 81
J5 Bus (280P)		2.5 D	2498	54	09.1981	09.1990	CRD93 (U25/661)	4	G 41
J5 Bus (290P)		1.9 D	1905	51	10.1990	02.1994	D9B (XUD9A)	4	G 41
		2.5 D	2500	54	10.1990	02.1994	CRD93 (U25/661)	4	G 41
		2.5 D 4x4	2500	54	10.1990	02.1994	CRD93 (U25/661)	4	G 41
		2.5 TD	2500	70	10.1990	02.1994	CRD93LS (U25/673)	4	G 41
		2.5 TD 4x4	2500	70	10.1990	02.1994	CRD93LS (U25/673)	4	G 41
J5 Camionnette (280L)		2.5 D	2498	54	09.1981	08.1990	CRD93	4	G 41
		2.5 TD	2498	70	09.1981	08.1990	CRD93LS (U25/673), CRD93L	4	G 41
J5 Camionnette (290L)		1.9 D	1905	51	10.1990	01.1994	D9B (XUD9A)	4	G 41
		2.5 D	2500	54	10.1990	01.1994	CRD93	4	G 41
		2.5 D 4x4	2500	54	10.1990	03.1994	CRD93 (U25/661)	4	G 41
		2.5 TD	2500	70	10.1990	01.1994	CRD93L	4	G 41
		2.5 TD 4x4	2500	70	10.1990	03.1994	CRD93LS (U25/673)	4	G 41
J5 Camion/Plate-forme (280L)		2.5 D	2500	54	09.1981	09.1990	CRD93 (U25/661)	4	G 41
		2.5 TD	2500	70	09.1981	09.1990	CRC93L	4	G 41
J5 Camion/Plate-forme (290L)		1.9 D	1905	51	10.1990	02.1994	D9B (XUD9A)	4	G 41
		2.5 D	2500	54	10.1990	02.1994	CRD93 (U25/661)	4	G 41
		2.5 D 4x4	2500	54	10.1990	02.1994	CRD93 (U25/661)	4	G 41
		2.5 TD	2500	70	10.1990	02.1994	CRD93LS (U25/673)	4	G 41





kW



Cyl.



PEUGEOT

	2.5 TD 4x4	2500	70	10.1990	02.1994	CRD93LS (U25/673)	4	G 41
J7 Bus	2.3 D	2304	49	07.1977	03.1980	XD2P94	4	G 41
J7 Camionnette	2.3 D	2304	49	07.1977	03.1980	XD2P94	4	G 41
J7 Camion/Plate-forme	2.3 D	2304	49	07.1977	03.1980	XD2P94	4	G 41
J9 Bus	2.3 D	2304	49	03.1980	07.1982	XD2PX94	4	G 41
	2.5 D	2497	53	08.1982	06.1987	XD3P	4	G 41
J9 Camionnette	2.1 D	2112	41	03.1980	06.1987	XDPX90	4	G 41
	2.3 D	2304	49	03.1980	07.1982	XD2PX94	4	G 41
	2.5 D	2497	53	07.1982	06.1987	XD3P	4	G 41
J9 Camion/Plate-forme	2.3 D	2304	49	03.1980	07.1982	XD2PX94	4	G 41
	2.5 D	2497	53	07.1982	06.1987	XD3P	4	G 41
PARTNER Combispace (5F)	1.6 HDi 75	1560	55	02.2006		9HW (DV6BTED4)	4	G 72
	1.6 HDi 90	1560	66	02.2006		9HX (DV6ATED4)	4	G 72
	1.6 HDi 90	1560	66	02.2006		9HX (DV6ATED4)	4	G 6
	1.9 D	1905	50	06.1996		DJY (XUD9A)	4	G 41
	1.9 D	1868	51	12.1998		WJY (DW8B), WJZ (DW8)	4	G 34
	1.9 D	1905	51	05.1996	12.1998	XUD9	4	G 41
	1.9 D 4x4	1868	51	04.2004	08.2005	WJY (DW8B)	4	G 34
	2.0 HDi	1997	66	02.2000		RHY (DW10TD)	4	G 57
	2.0 HDi 4x4	1997	66	04.2004	08.2005	RHY (DW10TD)	4	G 57
PARTNER Camionnette	NEW 1.6 BlueHDi 100	1560	73	04.2015		BHY (DV6FD)	4	GPE 81
	NEW 1.6 BlueHDi 120	1560	88	04.2015		BHZ (DV6FC)	4	GPE 81
	1.6 HDi	1560	55	04.2008		9HT, 9HW (DV6BTED4), 9HN (DV6ETED4)	4	G 72
	NEW 1.6 HDi / BlueHDi 75	1560	55	01.2014		BHW (DV6FE) 9HN (DV6ETED)	4	GPE 81
	1.6 HDi	1560	66	04.2008		9HX (DV6ATED4), 9HS (DV6TED4BU)	4	G 72
	1.6 HDi	1560	66	04.2008		9HX (DV6ATED4), 9HS (DV6TED4BU)	4	G 6
	NEW 1.6 HDi	1560	66	03.2013		9HF (DV6DTED)	4	GPE 81
	NEW 1.6 HDi 90	1560	68	04.2010		9HP (DV6DTED)	4	GPE 81
	1.6 HDi	1560	80	04.2008		9HZ (DV6TED4)	4	G 72
	NEW 1.6 HDi	1560	82	08.2010			4	GPE 81
	NEW 1.6 HDi	1560	84	03.2013		9HL (DV6C)	4	GPE 81
PARTNER Camionnette (5)	1.6 HDi 75	1560	55	02.2006		9HW (DV6BTED4)	4	G 72
	1.6 HDi 90	1560	66	02.2006		9HX (DV6ATED4)	4	G 72
	1.6 HDi 90	1560	66	02.2006		9HX (DV6ATED4)	4	G 6
	1.6 HDi 90	1560	80	04.2008		9HZ (DV6TED4)	4	G 6
	1.8 D	1769	43	06.1996		A9A (XUD7)	4	G 41
	1.8 D	1769	44	11.1996	02.1998	A9A (XUD7)	4	G 41
	1.9 D	1905	50	05.1996	12.1998	DJY (XUD9A)	4	G 41
	1.9 D	1905	51	06.1996		DJY (XUD9A)	4	G 41
	1.9 D	1868	51	06.1996		WJY (DW8B)/WJZ (DW8)	4	G 34
	1.9 D 4x4	1868	51	04.2004		WJY (DW8B)	4	G 34
	2.0 HDi	1997	66	04.2000		RHY (DW10TD)	4	G 57
	2.0 HDi 4x4	1997	66	04.2004		RHY (DW10TD)	4	G 57
PARTNER Camion/Plate-forme	1.6 HDi 16V	1560	66	01.2009		9HX (DVATED4), 9HS (DV6TED4BU)	4	G 72
	1.6 HDi 16V	1560	66	01.2009		9HX (DVATED4), 9HS (DV6TED4BU)	4	G 6
	NEW 1.6 HDi	1560	66	03.2013		9HF (DV6DTED)	4	GPE 81
PARTNER Tepee	1.6 HDi	1560	55	04.2008		9HT, 9HW (DV6BTED4), 9HN (DV6ETED4)	4	G 72
	1.6 HDi	1560	55	04.2008		9HT, 9HW (DV6BTED4), 9HN (DV6ETED4)	4	G 6
	NEW 1.6 BlueHDi 75	1560	55	03.2015		BHW (DV6FE)	4	GPE 81
	1.6 HDi	1560	66	04.2008		9HX (DV6ATED4), 9HV (DV6TED4)	4	G 6
	NEW 1.6 HDi	1560	66	03.2013		9HF (DV6DTED)	4	GPE 81
	NEW 1.6 HDi 90	1560	68	04.2010		9HP (DV6DTED)	4	GPE 81
	NEW 1.6 BlueHDi 100	1560	73	12.2014		BHY (DV6FD)	4	GPE 81
	NEW 1.6 BlueHDi 120	1560	88	12.2014		BHZ (DV6FC)	4	GPE 81
	1.6 HDi	1560	80	04.2008		9HZ (DV6TED4)	4	G 6
	NEW 1.6 HDi	1560	82	08.2010		9HL (DV6C)	4	GPE 81
	NEW 1.6 HDi	1560	84	03.2013		9HL (DV6C)	4	GPE 81
TRAVELLER	NEW 1.6 BlueHDi 95	1560	70	04.2016		BHV-BHS (DV6FDU)	4	GPE 81
	NEW 1.6 BlueHDi 115	1560	85	04.2016		DV6C/DV6FC	4	GPE 81
	NEW 2.0 BlueHDi 150	1997	110	04.2016		AHX (DW10FD)	4	GPE 81
	NEW 2.0 BlueHDi 180	1997	130	04.2016		AHH (DW10FC)	4	GPE 81

PORSCHE

CAYENNE (92A)	3.0 TDI	2967	155	06.2010		MCR.CB	6	GPE 74
	3.0 TDI	2967	176	02.2009		M05. 9D	6	GPE 74

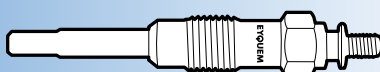

EYQUEM



kW



Cyl.



PORSCHE

	3.0 TDI	2967	176	06.2010		M05.9E	6	GPE 74
	3.0 TDI	2967	180	06.2011		MCR.CA	6	GPE 74
	NEW 3.0 Diesel	2967	184	08.2014		MCV.VB	6	GPE 74
	NEW 3.0 Diesel	2967	193	10.2014		MCV.VA	6	GPE 74
	NEW 4.2 S Diesel	4134	281	10.2012		MCU.DB	8	GPE 74
	NEW 4.2 S Diesel	4134	283	10.2014		MCU.DC	8	GPE 74
MACAN (95B)	NEW 3.0 S Diesel	2967	155	02.2014		MCT.BB	6	GPE 74
	NEW 3.0 S Diesel	2967	184	02.2014		MCT.BC	6	GPE 74
	NEW 3.0 S Diesel	2967	190	02.2014		MCT.BA	6	GPE 74
PANAMERA (970)	NEW 3.0 Diesel	2967	155	08.2011	07.2013	MCR.CB	6	GPE 74
	NEW 3.0 Diesel	2967	184	08.2011	07.2013	MCR.CC	6	GPE 74
	NEW 3.0 Diesel	2967	221	07.2013	10.2016	MCW.JA	6	GPE 74

PROTON

PERSONA 400 (C9_S)	420 GLS D	1998	48	05.1996		4 D 68	4	G 69
	420 TD	1998	60	09.1996		4 D 68 T	4	G 69

PUCH

G-MODELL (W 460)	240 GD	2399	53	03.1979	08.1987	OM 616.936	4	G 41
	240 GD	2399	53	03.1979	08.1987	OM 616.936	4	G 41
	240 GD	2399	53	03.1979	08.1987	OM 616.936	4	G 41
	240 GD	2399	53	03.1979	08.1987	OM 616.936	4	G 41
	250 GD	2497	62	10.1987	12.1992	OM 602.930	5	G 24
	250 GD	2497	62	10.1987	12.1992	OM 602.930	5	G 41
	250 GD	2497	62	10.1987	12.1992	OM 602.930	5	G 41
	250 GD	2497	62	10.1987	12.1992	OM 602.930	5	G 24
	250 GD	2497	62	10.1987	12.1992	OM 602.930	5	G 41
	250 GD	2497	62	10.1987	12.1992	OM 602.930	5	G 41
	250 GD	2497	62	10.1987	12.1992	OM 602.930	5	G 41
	250 GD	2497	62	10.1987	12.1992	OM 602.930	5	G 41
	250 GD	2497	62	10.1987	12.1992	OM 602.930	5	G 41
	250 GD	2497	62	10.1987	12.1992	OM 602.930	5	G 41
	250 GD	2497	62	10.1987	12.1992	OM 602.930	5	G 41
	300 GD	2998	65	12.1979	12.1991	OM 617.931	5	G 41
	300 GD	2998	65	12.1979	12.1991	OM 617.931	5	G 41
	300 GD	2998	65	12.1979	12.1991	OM 617.931	5	G 41
	300 GD	2998	65	12.1979	12.1991	OM 617.931	5	G 41
G-MODELL (W 461)	290 GD/G 290 D	2874	70	04.1992		OM 602.942	5	G 24
	G 290 TD	2874	88	07.1997		OM 602.983	5	G 24
G-MODELL (W 463)	300 GD	2996	83	09.1989		OM 603.931	6	G 24
	350 G Turbo D	3449	100	09.1991		OM 603.972	6	G 24
	G 300 TD	2996	130	08.1996		OM 606.964	6	G 61

RENAULT

9 (L42_)	1.6 D	1596	40	10.1982	12.1988	F8M 730-700-720	4	G 27
11 (B/C37_)	1.6 D	1596	40	08.1983	12.1988	F8M 730-700-720	4	G 27
11 Camionnette (S37_)	1.6 D	1596	40	08.1983	12.1988	F8M 730-700-720	4	G 27
18 (134_)	2.1 Diesel	2068	49	11.1981	07.1986	852 710 - J8S 711	4	G 41
	2.1 Diesel	2068	53	11.1981	07.1986	J8S 711	4	G 41
	2.1 TD	2068	65	11.1981	07.1986	J8S 712	4	G 41
18 Camionnette	2.1 Diesel	2068	49	11.1981	07.1986	852 710 - J8S 711	4	G 41
18 Variable (135_)	2.1 Diesel	2068	49	11.1980	07.1986	852 710 - J8S 711	4	G 41
	2.1 Diesel	2068	53	05.1979	07.1986	J8S 711	4	G 41
19 I (B/C53_)	1.9 D	1870	47	09.1988	02.1991	F8Q 706-742	4	G 41
	1.9 D	1870	47	03.1991	04.1992	F8Q 706-742	4	G 27
	1.9 DT	1870	68	09.1990	04.1992	F8Q 610	4	G 41
19 I Chamade (L53_)	1.9 D	1870	47	10.1989	04.1992	F8Q 706-742	4	G 27
	1.9 D	1870	47	10.1989	04.1992	F8Q 706-742	4	G 41
	1.9 TD	1870	68	09.1990	04.1992	F8Q 740	4	G 49
19 I Camionnette (S53_)	1.9 D	1870	48	01.1988	02.1991	F8Q 706-742	4	G 41
	1.9 D	1870	48	01.1991	12.1992	F8Q 706-742	4	G 27
19 II (B/C53_)	1.9 D	1870	47	04.1992	12.1995	F8Q 742	4	G 27
	1.9 dT	1870	66	04.1992	12.1995	F8Q 744	4	G 49
19 II Chamade (L53_)	1.9 D	1870	47	04.1992	12.1995	F8Q 742	4	G 27
	1.9 dT	1870	66	04.1992	12.1995	F8Q 744	4	G 49
	1.9 D	1870	68	05.1992	11.1995	F8Q 744	4	G 49
19 II Camionnette (S53_)	1.9 D	1870	48	03.1992	12.1995	F8Q 706-742	4	G 27
	1.9 dT	1870	68	03.1992	12.1995	F8Q 740	4	G 49

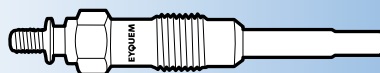



kW



Cyl.



RENAULT

20 (127_)	2.1 D	2068	47	10.1980	12.1983	852	4	G 41
	2.1 TD	2068	63	01.1982	12.1983	J8S 702	4	G 41
21 (B48_)	1.9 D	1870	47	09.1989	10.1993	F8Q 710	4	G 27
	2.1 D	2068	50	07.1989	05.1993	J8S 704-784	4	G 41
	2.1 D	2068	51	04.1992	06.1994	J8S 784	4	G 41
	2.1 D	2068	53	09.1989	12.1992	J8S 740-600	4	G 41
	2.1 Turbo-D	2068	65	09.1989	06.1994	J8S 788-786-714	4	G 41
21 Camionnette (S48_)	1.9 D	1870	47	06.1986	08.1994	F8Q 710	4	G 41
	2.1 D	2068	49	06.1986	08.1994	J8S 704	4	G 41
	1.9 D	1870	47	03.1986	08.1994	F8Q 710	4	G 41
	2.1 D, 4x4	2068	48	10.1986	09.1990	J8S 704	4	G 41
	2.1 D	2068	51	02.1992	09.1995	J8S 784	4	G 41
	2.1 D	2068	53	08.1989	12.1992	J8S 740-600	4	G 41
	2.1 Turbo-D	2068	65	10.1986	11.1993	J8S 788-786-714	4	G 41
21 Tricorps (L48_)	1.9 D	1870	47	08.1989	10.1993	F8Q 710	4	G 41
	2.1 D	2068	48	03.1986	12.1989	J8S 704	4	G 41
	2.1 TD	2068	50	04.1986	06.1989	J8S 704	4	G 41
	2.1 D	2068	51	10.1992	06.1994	J8S 784	4	G 41
	2.1 D	2068	53	05.1989	06.1994	J8S 740-600	4	G 41
	2.1 Turbo-D	2068	65	03.1986	06.1994	J8S 788-786-714	4	G 41
25 (B29_)	2.1 Diesel	2068	46	04.1984	05.1989	J8S 706	4	G 41
	2.1 Diesel	2068	51	06.1989	12.1992	J8S 736	4	G 41
	2.1 Turbo-D	2068	63	04.1984	12.1992	J8S 708-738	4	G 41
30 (127_)	2.1 Turbo-D	2068	63	02.1982	03.1986	J8S 702	4	G 41
AVANTIME (DE0_)	2.2 dCi (DE01)	2188	110	05.2002	05.2003	G9T 712	4	G 63
CAPTUR (J5)	NEW 1.5 dCi 90	1461	66	06.2013		K9K 608-609-830-612	4	GPE 78
	NEW 1.5 dCi 110	1461	81	01.2015		K9K 646	4	GPE 78
CLIO Grandtour (KR0/1_)	1.5 dCi	1461	48	02.2010		K9K 752	4	G 28
	1.5 dCi	1461	50	02.2008		K9K 768-714	4	G 28
	1.5 dCi	1461	55	08.2010		K9K 770	4	G 28
	1.5 dCi	1461	63	02.2008		K9K 766	4	G 28
	1.5 dCi	1461	65	08.2010		K9K 770-772	4	G 28
	1.5 dCi	1461	76	02.2008		K9K 772	4	G 28
	1.5 dCi	1461	78	02.2008		K9K 764-774	4	G 28
CLIO I (B/C57_, 5/357_)	1.9 D	1870	40	01.1997	09.1998	F8Q 678	4	G 27
	1.9 D	1870	47	01.1991	09.1998	F8Q 730,F8Q 732	4	G 27
	1.9 D	1870	48	05.1996	02.1998	F8Q 696, 676, 714, 632	4	G 27
CLIO I Camionnette (S57_)	1.9 D	1870	40	04.1996	02.1998	F8Q 678	4	G 41
	1.9 D	1870	48	01.1991	09.1998	F8Q 730,F8Q 732	4	G 27
CLIO II (BB0/1/2_, CB0/1/2_)	1.5 D	1461	50	08.2004		K9K 714	4	G 28
	1.5 dCi	1461	42	06.2001	12.2006	K9K 704	4	G 28
	1.5 dCi	1461	47	06.2005		K9K 740	4	G 28
	1.5 dCi	1461	48	06.2001		K9K 704-700	4	G 28
	1.5 dCi	1461	50	08.2004		K9K 700-714	4	G 28
	1.5 dCi	1461	59	06.2001	10.2003	K9K 702	4	G 28
	1.5 dCi	1461	60	06.2001		K9K 702	4	G 28
	1.5 dCi	1461	62	02.2007		K9K 718	4	G 28
	1.5 dCi	1461	74	01.2004		K9K 712	4	G 28
	1.9 D	1870	47	09.1998	02.1999	F8Q 630	4	G 54
	1.9 D	1870	47	03.1999	05.2005	F8Q 630	4	G 29
	1.9 D	1870	48	02.2000	05.2001	F8Q 632	4	G 29
	1.9 dTi	1870	59	12.1999	05.2005	F9Q 780	4	G 28
CLIO II Camionnette (SB0/1/2_)	1.5 dCi	1461	48	06.2001		K9K 704-700	4	G 28
	1.5 dCi	1461	59	06.2001	10.2004	K9K 702	4	G 28
	1.5 dCi	1461	60	11.2003		K9K 702-710-716	4	G 28
	1.9 D	1870	40	03.1999	01.2000	F8Q 662	4	G 54
	1.9 D	1870	47	09.1998		F8Q 630	4	G 54
	1.9 D	1870	48	02.2000	05.2001	F8Q 632	4	G 54
	1.9 DTi	1870	59	02.2000	05.2001	F9Q 780	4	G 28
CLIO III (BR0/1, CR0/1)	1.5 dCi	1461	48	06.2005		K9K 752	4	G 28
	1.5 dCi	1461	50	06.2005		K9K 768-714	4	G 28
	1.5 dCi	1461	55	08.2010		K9K 770	4	G 28
	1.5 dCi	1461	60	11.2007		K9K 750	4	G 28
	1.5 dCi	1461	63	06.2005		K9K 766	4	G 28
	1.5 dCi	1461	65	08.2010		K9K 770	4	G 28





kW



Cyl.



RENAULT

		1.5 dCi	1461	76	06.2005		K9K 772	4	G 28
		1.5 dCi	1461	78	06.2005		K9K 764	4	G 28
CLIO IV (BH_)	NEW	1.5 dCi 75	1461	55	11.2012		K9K 612	4	GPE 78
	NEW	1.5 dCi 90	1461	66	11.2012		K9K 608	4	GPE 78
	NEW	1.5 dCi 110	1461	81	06.2016		K9K 646	4	GPE 78
CLIO IV Grandtour (KH_)	NEW	1.5 dCi 75	1461	55	01.2013		K9K 612	4	GPE 78
	NEW	1.5 dCi 90	1461	66	01.2013		K9K 608	4	GPE 78
	NEW	1.5 dCi 110	1461	81	06.2016		K9K 646	4	GPE 78
CLIO SYMBOL		1.5 dCi	1461	47	06.2005		K9K 740	4	G 28
		1.5 dCi	1461	48	04.2002		K9K 700	4	G 28
		1.5 dCi	1461	50	02.2003		K9K 714	4	G 28
		1.5 dCi	1461	60	06.2001		K9K 702	4	G 28
CLIO SYMBOL II		1.5 dCi	1461	47	09.2008		K9K 740	4	G 28
		1.5 dCi	1461	62	09.2008		K9K 718	4	G 28
ESPACE I (J11_)		2.1 TD (J/S115)	2068	65	10.1984	12.1990	J8S 774-240	4	G 41
ESPACE II (J/S63_)		2.1 TD	2068	65	01.1991	10.1996	J8S 776-772-778-610	4	G 41
		2.1 TD	2068	66	11.1994	10.1996	J8S 612	4	G 41
		2.1 RTD Quadra	2068	65	01.1991	05.1992	J8S 772	4	G 41
ESPACE III (JEO_)		1.9 dTi	1870	72	02.1999	10.2002	F9Q 722	4	G 28
		2.2 12V TD	2188	83	11.1996	10.2000	G8T 716-714-760	4	G 51
		2.2 D	2188	84	11.1997	01.2000	G8T 716	4	G 51
		2.2 dCi	2188	85	07.2000	10.2002	G9T 710	4	G 63
		2.2 dCi	2188	95	10.2000	10.2002	G9T 710-642	4	G 63
ESPACE IV (JK0/1_)		1.9 dCi	1870	85	04.2003	02.2005	F9Q 820	4	G 28
		1.9 dCi	1870	88	11.2002		F9Q 680-820-826	4	G 28
	NEW	2.0 dCi (JK02, JK03)	1995	96	01.2006		OE : 110651749R	4	GPE 93
	NEW	2.0 dCi (JK01, JK02, JK1J, JK1K)	1995	110	01.2006		OE : 110651749R	4	GPE 93
	NEW	2.0 dCi (JK03, JK04)	1995	127	01.2006		OE : 110651749R	4	GPE 93
		2.2 dCi	2188	102	02.2006		G9T 645	4	G 63
		2.2 dCi	2188	110	11.2002		G9T 742-743	4	G 63
ESPACE V (JR_)	NEW	1.6 dCi 130	1598	96	06.2015		R9M 409	4	GPE 93
	NEW	1.6 dCi 160	1598	118	06.2015		R9M 452	4	GPE 93
EXPRESS Camionnette (F40_ G40_)		1.6 D	1596	40	03.1986	08.1998	F8M 720-730-736-760	4	G 27
		1.9 D	1870	40	09.1994	03.1998	F8Q 640-682	4	G 50
		1.9 D	1870	47	09.1991	03.1998	F8Q 646-722-724-774-776	4	G 27
EXPRESS Pick-up		1.9 D	1870	40	07.1995	10.1997	F8Q 640	4	G 41
		1.9 D	1870	40	07.1995	10.1997	F8Q 640	4	G 50
		1.9 D	1870	47	07.1995	10.1999	F8Q 724-726	4	G 41
		1.9 D	1870	47	07.1995	10.1999	F8Q 724-726	4	G 50
FLUENCE (L30)	NEW	1.5 dCi	1461	63	02.2010		K9K 830	4	GPE 78
	NEW	1.5 dCi	1461	66	02.2010		K9K 834	4	GPE 78
	NEW	1.5 dCi	1461	70	07.2014		K9K 826	4	GPE 78
	NEW	1.5 dCi	1461	78	06.2005		K9K 830	4	GPE 78
	NEW	1.5 dCi	1461	81	02.2010		K9K 836-837	4	GPE 78
	NEW	1.6 dCi	1598	96	07.2014		R9M 402	4	GPE 93
FUEGO (136_)		2.1 TD	2068	65	08.1982	10.1985	J8S 712	4	G 41
GRAND SCÉNIC II (JM0/1_)		1.5 dCi	1461	74	04.2004		K9K 728	4	G 28
		1.5 dCi	1461	76	06.2006	11.2008	K9K 734	4	G 28
		1.5 dCi	1461	78	05.2005		K9K P 732	4	G 28
		1.9 dCi	1870	81	05.2005		F9Q E 804	4	G 28
		1.9 dCi	1870	85	05.2005	01.2009	F9Q 803-804-812	4	G 28
		1.9 dCi	1870	88	04.2004		F9Q 812	4	G 28
		1.9 dCi	1870	96	05.2005		F9Q J 803- F9Q EE 804- F9Q 816-818	4	G 28
GRAND SCÉNIC III (JZ0/1_)	NEW	1.5 dCi	1461	63	04.2009		K9K 830	4	GPE 78
	NEW	1.5 dCi	1461	70	11.2010		K9K 846	4	GPE 78
	NEW	1.5 dCi	1461	78	02.2009		K9K 832	4	GPE 78
	NEW	1.5 dCi	1461	81	04.2009		K9K 636-836-837	4	GPE 78
	NEW	1.6 dCi (JZ00, JZ12)	1598	96	04.2011		R9M 402-404-414	4	GPE 93
	NEW	1.9 dCi	1970	96	02.2009		F9Q 870-872	4	GPE 79
GRAND SCÉNIC IV (R9_)	NEW	1.5 dCi 110	1461	81	09.2016		K9K 646-K9K 647	4	GPE 78
	NEW	1.5 dCi 110 Hybrid Assist	1461	81	04.2017		K9K 500	4	GPE 78
	NEW	1.6 dCi 130	1598	96	09.2016		R9M 409	4	GPE 93
	NEW	1.6 dCi 160	1598	118	09.2016		R9M 452	4	GPE 93
KADJAR (HA_ HL_)	NEW	1.5 dCi	1461	81	06.2015		K9K 646-K9K 647	4	GPE 78
	NEW	1.6 dCi 130	1598	96	06.2015		R9M 414	4	GPE 93





kW



Cyl.



RENAULT

	NEW	1.6 dCi 130 4x4	1598	96	06.2015		R9M 414	4	GPE 93	
KANGOO (KC0/1_)		1.5 dCi	1461	42	07.2003		K9K 704	4	G 28	
		1.5 dCi	1461	45	04.2005	06.2010	K9K 700 -702	4	G 28	
		1.5 dCi	1461	48	12.2001		K9K 700-704	4	G 28	
		1.5 dCi	1461	50	06.2005		K9K 714	4	G 28	
		1.5 dCi	1461	60	07.2002		K9K 702-710	4	G 28	
		1.5 dCi	1461	62	06.2005		K9K 718	4	G 28	
		D 55 1.9	1870	40	03.1999		F8Q 662	4	G 29	
		D 55 1.9	1870	40	08.1997	02.1999	F8Q 662	4	G 54	
		D 65 1.9	1870	47	08.1997		F8Q 632	4	G 29	
		D 65 1.9	1870	47	08.1997		F8Q 630	4	G 54	
	1.9 RXED	1870		09.1999	06.2001	F8Q 632-630	4	G 54		
	1.9 dTi	1870	59	02.2000		F9Q 780	4	G 28		
	1.9 dCi 4x4	1870	59	10.2001		F9Q 790-782	4	G 28		
	1.9 dCi 4x4	1870	62	10.2003		F9Q 790	4	G 28		
KANGOO / GRAND KANGOO (KW0/1_)		1.5 dCi	1461	50	02.2008		K9K 714-800-840	4	G 28	
	NEW	1.5 dCi	1461	50	02.2008		K9K 714-800-840	4	GPE 78	
		1.5 dCi	1461	55	11.2012		K9K 802-608	4	G 28	
	NEW	1.5 dCi	1461	55	11.2012		K9K 802-608	4	GPE 78	
		1.5 dCi	1461	63	02.2008		K9K 802	4	G 28	
	NEW	1.5 dCi	1461	63	02.2008		K9K 802	4	GPE 78	
		1.5 dCi	1461	66	11.2012		K9K 808	4	G 28	
	NEW	1.5 dCi	1461	66	11.2012		K9K 808	4	GPE 78	
	NEW	1.5 dCi	1461	67	08.2017		K9K 647	4	GPE 78	
		1.5 dCi	1461	76	02.2008		K9K 804-806	4	G 28	
	NEW	1.5 dCi	1461	76	02.2008		K9K 804-806	4	GPE 78	
		1.5 dCi	1461	78	02.2008		K9K 804	4	G 28	
	NEW	1.5 dCi	1461	78	02.2008		K9K 804	4	GPE 78	
		1.5 dCi 110	1461	80	09.2010		K9K 804	4	G 28	
	NEW	1.5 dCi 110	1461	80	09.2010		K9K 804	4	GPE 78	
	NEW	1.5 dCi 110	1461	81	03.2013		K9K 636	4	GPE 78	
	KANGOO BE BOP (KW0/1_)		1.5 dCi 75	1461	55	09.2010		K9K 802	4	G 28
NEW		1.5 dCi 75	1461	55	09.2010		K9K 802	4	GPE 78	
		1.5 dCi	1461	66	06.2009		K9K 808	4	G 28	
NEW		1.5 dCi	1461	66	06.2009		K9K 808	4	GPE 78	
		1.5 dCi	1461	76	02.2009		K9K 806	4	G 28	
NEW		1.5 dCi	1461	76	02.2009		K9K 806	4	GPE 78	
		1.5 dCi	1461	80	06.2009		K9K 804	4	G 28	
KANGOO BEBOP		NEW	1.5 dCi 110	1461	80	06.2009		K9K 804	4	GPE 78
KANGOO Express (FC0/1_)			1.5 dCi	1461	42	12.2002		K9K 704	4	G 28
			1.5 dCi	1461	45	10.2005		K9K 706	4	G 28
		1.5 dCi	1461	48	12.2001		K9K 700-702-704	4	G 28	
		1.5 dCi	1461	50	06.2005		K9K 714	4	G 28	
		1.5 dCi	1461	60	04.2003		K9K 702-710	4	G 28	
		1.5 dCi	1461	62	06.2005		K9K 718	4	G 28	
	KANGOO Express (FW0/1_)		1.5 dCi 85	1461	63	02.2008		K9K 800-802	4	G 28
KANGOO Express (FC0/1_)		D 55 1.9	1870	40	03.1999		F8Q 662	4	G 29	
		D 55 1.9	1870	40	08.1997	02.1999	F8Q 662	4	G 54	
		D 65 1.9	1870	47	08.1997		F8Q 632	4	G 29	
		D 65 1.9	1870	47	08.1997		F8Q 630	4	G 54	
		1.9 D	1870	48	09.1999	02.2003	F8Q 632	4	G 29	
		1.9 dTi	1870	59	02.2000		F9Q 780	4	G 28	
		1.9 dCi 4x4	1870	59	10.2001		F9Q 782-790	4	G 28	
		1.9 dCi	1870	62	07.2003		F9Q 782-790	4	G 28	
		1.9 dCi 4x4	1870	62	07.2003		F9Q 790	4	G 28	
	KANGOO Express (FW0/1_)		1.5 dCi	1461	50	02.2008		K9K 800	4	G 28
NEW		1.5 dCi	1461	50	02.2008		K9K 800	4	GPE 78	
		1.5 dCi 75	1461	55	09.2010		K9K 800-808	4	G 28	
NEW		1.5 dCi 75	1461	55	09.2010		K9K 800-808	4	GPE 78	
		1.5 dCi	1461	63	02.2008		K9K 800-802	4	G 28	
NEW		1.5 dCi	1461	63	02.2008		K9K 800-802	4	GPE 78	
NEW		1.5 dCi 90	1461	66	06.2009		K9K 808-608	4	G 28	
NEW		1.5 dCi 90	1461	66	06.2009		K9K 808-608	4	GPE 78	
NEW		1.5 dCi 90	1461	67	08.2017		K9K 647	4	GPE 78	
		1.5 dCi	1461	76	02.2008		K9K 806	4	G 28	





kW



Cyl.



RENAULT

	NEW	1.5 dCi	1461	76	02.2008		K9K 806	4	GPE 78
		1.5 dCi 110	1461	80	09.2010		K9K 804	4	G 28
	NEW	1.5 dCi 110	1461	80	09.2010		K9K 804	4	GPE 78
	NEW	1.5 dCi 110	1461	81	03.2013		K9K 636	4	GPE 78
KOLEOS II	NEW	1.6 dCi 130	1598	96	08.2016		R9M 409-414	4	GPE 93
	NEW	2.0 dCi 175 4WD	1995	130	08.2016		M9R 868	4	GPE 93
LAGUNA I (B56_, 556_)		1.9 dTi	1870	72	10.1997	03.2001	F9Q 710	4	G 28
		1.9 dTi	1870	72	10.1997	03.2001	F9Q 716	4	G 51
		1.9 dCi	1870	79	09.1999	03.2001	F9Q 718	4	G 28
		2.2 D	2188	61	11.1993	03.2001	G8T 706-752 790-794	4	G 51
		2.2 dT	2188	83	03.1996	03.2001	G8T 760	4	G 51
LAGUNA I Nevada (K56_)		1.9 dTi	1870	72	10.1997	03.2001	F9Q 710	4	G 28
		1.9 dTi	1870	72	10.1997	03.2001	F9Q 716	4	G 51
		1.9 dCi	1870	79	09.1999	03.2001	F9Q 718	4	G 28
		2.2 D	2188	61	09.1995	03.2001	G8T 706-752-790-794	4	G 51
		2.2 dT	2188	83	03.1996	03.2001	G8T 760	4	G 51
LAGUNA II (BG0/1_)		1.9 dCi	1870	68	03.2004		F9Q 664	4	G 28
		1.9 dCi	1870	74	10.2001		F9Q 754	4	G 28
		1.9 dCi	1870	77	06.2001		F9Q 752	4	G 28
		1.9 dCi	1870	79	03.2001		F9Q 718-754	4	G 28
		1.9 dCi	1870	81	01.2005		F9Q 674-758	4	G 28
		1.9 dCi	1870	85	09.2005		F9Q 750	4	G 28
		1.9 dCi	1870	88	03.2001		F9Q 650-670-674	4	G 28
		1.9 dCi	1870	92	09.2005		F9Q 750	4	G 28
		1.9 dCi	1870	96	05.2005		F9Q 758-759	4	G 28
		2.2 dCi	2188	102	05.2005		G9T 600-605-706-707	4	G 63
		2.2 dCi	2188	110	10.2001		G9T 700-702	4	G 63
LAGUNA II Nevada (KGO/1_)		1.9 dCi	1870	66	08.2003	09.2007	F9Q 664	4	G 28
		1.9 dCi	1870	68	03.2004		F9Q 664	4	G 28
		1.9 dCi	1870	74	10.2001		F9Q 752	4	G 28
		1.9 dCi	1870	77	06.2001		F9Q 752	4	G 28
		1.9 dCi	1870	79	03.2001		F9Q 718-754	4	G 28
		1.9 dCi	1870	81	01.2005		F9Q 674-758	4	G 28
		1.9 dCi	1870	85	08.2005	09.2007	F9Q 758-759	4	G 28
		1.9 dCi	1870	88	03.2001		F9Q 670-674-750	4	G 28
		1.9 dCi	1870	92	09.2005		F9Q 750	4	G 28
		1.9 dCi	1870	96	05.2005		F9Q 758-759	4	G 28
		2.2 dCi	2188	102	05.2005		G9T 600-706-707	4	G 28
		2.2 dCi	2188	110	10.2001		G9T 702	4	G 63
LAGUNA III (BT0/1)		1.5 dCi	1461	81	10.2007		K9K 780	4	G 28
	NEW	2.0 dCi (BT07,BT0J,BT14, BT1A,BT1S,....)	1995	96	10.2007		OE : 110651749R	4	GPE 93
	NEW	2.0 dCi (BT01,BT08,BT09, BTOE,BTOK,....)	1995	110	10.2007		OE : 110651749R	4	GPE 93
	NEW	2.0 dCi (BTOM,BTON,BTOS, BT19,BT1F)	1995	127	01.2008		OE : 110651749R	4	GPE 93
	NEW	2.0 dCi GT (BT11,BT1E,BT1N)	1995	131	03.2008		OE : 110651749R	4	GPE 93
LAGUNA III Grandtour (KTO/1)		1.5 dCi	1461	81	10.2007		K9K 780	4	G 28
	NEW	2.0 dCi (KT07,KTOJ,KT14, KT1A,KT1S)	1995	96	10.2007		OE : 110651749R	4	GPE 93
	NEW	2.0 dCi (KT01,KT08,KT09, KTOK,KT12,....)	1995	110	10.2007		OE : 110651749R	4	GPE 93
	NEW	2.0 dCi (KTOM,KTON,KTOS, KT19,KT1F)	1995	127	01.2008		OE : 110651749R	4	GPE 93
	NEW	2.0 dCi GT (KT11,KT1E,KT1N)	1995	131	03.2008		OE : 110651749R	4	GPE 93
LAGUNA Coupé (DT0/1)	NEW	1.5 dCi	1461	81	03.2012		K9K 846	4	GPE 78
	NEW	2.0 dCi (DT01,DT08,DT09, DTOK,DT12,....)	1995	110	09.2008		OE : 110651749R	4	GPE 93
	NEW	2.0 dCi (DTOM,DTON,DTOS, DT19,DT1F)	1995	127	09.2008		OE : 110651749R	4	GPE 93
	NEW	2.0 dCi GT (DT11,DT1E,DT1N)	1995	131	09.2008		OE : 110651749R	4	GPE 93
LATITUDE (L70_)	NEW	1.5 dCi	1461	81	07.2010		K9K 782	4	GPE 78
	NEW	2.0 dCi 150 (L70H)	1995	110	02.2011		OE : 110651749R	4	GPE 93
	NEW	2.0 dCi 175 (L70Y)	1995	127	05.2001		OE : 110651749R	4	GPE 93
	NEW	2.0 dCi	1995	130	02.2011		OE : 110651749R	4	GPE 93





kW



Cyl.



RENAULT

LOGAN (LS_)	1.5 dCi	1461	48	06.2011		K9K 700-790-794	4	G 28
	1.5 dCi	1461	50	04.2007		K9K 792	4	G 28
	1.5 dCi	1461	63	02.2008		K9K 796	4	G 28
LOGAN MCV (KS_)	1.5 dCi	1461	48	06.2011		K9K 790-794	4	G 28
	1.5 dCi	1461	50	04.2007		K9K 792	4	G 28
	1.5 dCi	1461	63	02.2008		K9K 796	4	G 28
	NEW 1.5 dCi	1461	66	06.2011			4	GPE 78
MASTER I Bus (T_)	28-35 2.1 D	2068	44	01.1986	07.1998	J8S 330	4	G 41
	28-35 2.4 D	2445	52	08.1980	08.1989	8140.61.2300 - S8U 731	4	G 41
	28-35 2.4 D	2445	53	09.1986	10.1989	S8U 731	4	G 41
	28-35 2.5 D	2499	55	08.1989	07.1998	8140.67.2510 - S8U 742	4	G 41
	35 2,5 TD	2499	69	08.1989	07.1998	8140.27.2500-2510 - S9U 714	4	G 35
	28-35 2,5 TD	2499	72	08.1989	07.1998	8140.27.2580 - S9U 702	4	G 41
MASTER I Camionnette (T_)	28-35 2.1 D	2068	44	01.1986	07.1998	J8S 330	4	G 41
	2.4 D	2445	50	07.1980	06.1983	S8U 731	4	G 41
	28-35 2.4 D	2445	52	08.1980	08.1989	8140.61.2300 - S8U 731	4	G 41
	2.4 D	2445	53	09.1986	12.1992	S8U 730	4	G 41
	28-35 2,5 D	2499	55	08.1989	07.1998	8140.67.2510 - S8U 742	4	G 41
	35 2,5 TD	2499	69	08.1989	07.1998	8140.27.2500-2510 - S9U 714-740	4	G 35
	28-35 2,5 TD	2499	72	08.1989	07.1998	8140.27.2580 - S9U 702	4	G 41
MASTER I Camion/Plate-forme (P_)	2.1 D	2068	46	11.1989	07.1993	J8S 330	4	G 41
	2.4 D	2445	52	08.1993	02.1998	S8U 730	4	G 41
	28-35 2.5 D	2445	52	09.1980	07.1998	8140.61.2300 - S8U 731	4	G 41
	2.5 D	2499	55	07.1980	10.1989	S8U 742	4	G 35
	2.5 TD	2499	69	11.1989	10.1993	S9U 702	4	G 41
MASTER II Bus (JD/ND)	1.9 dTi	1870	59	09.2000		F9Q 770	4	G 28
	1.9 dCi 80	1870	60	11.2001		F9Q 772-774	4	G 28
	2.2 dCi 90	2188	66	09.2000		G9T 720-722-750	4	G 63
	2.5 D	2499	59	07.1998	01.2001	S8U 770	4	G 35
	2.5 dCi 100	2463	73	10.2003		G9U 754	4	G 63
	2.5 dCi	2464	74	08.2006		G9U 754	4	G 63
	2.5 dCi 120	2463	84	10.2001		G9U 720-750-754	4	G 63
	2.5 dCi	2464	88	08.2006		G9U 650	4	G 63
	2.5 dCi	2464	107	08.2006		G9U 632	4	G 63
	2.8 dTi	2799	84	07.1998	10.2001	S9W 702	4	G 62
MASTER II Camionnette (FD)	1.9 dTi	1870	59	09.2000		F9Q 770	4	G 28
	1.9 dCi 80	1870	60	11.2001		F9Q 772-774	4	G 28
	2.2 dCi 90	2188	66	09.2000		G9T 720-722-750	4	G 63
	2.5 D	2499	59	07.1998	01.2001	S8U 770	4	G 35
	2.5 dCi 100	2463	73	10.2003		G9U 754	4	G 63
	2.5 dCi	2464	74	08.2006		G9U 650-754	4	G 63
	2.5 dCi 120	2463	84	10.2001		G9U 720-724-750-754	4	G 63
	2.5 dCi	2464	107	08.2006		G9U 632	4	G 63
	2.8 dTi	2799	84	07.1998	10.2001	S9W 702	4	G 62
MASTER II Camion/ Plate-forme (ED/HD/UD)	2.2 dCi 90	2188	66	09.2000		G9T 720-722-750	4	G 63
	2.5 D	2499	59	07.1998	01.2001	S8U 770	4	G 35
	2.5 dCi 100	2463	73	10.2003		G9U 754	4	G 63
	2.5 dCi 120	2463	84	10.2001		G9U 720-724-750-754	4	G 63
	2.5 dCi	2464	74	08.2006		G9U 650-754	4	G 63
	2.5 dCi	2464	88	08.2006		G9U 650	4	G 63
	2.5 dCi	2464	107	08.2006		G9U 632	4	G 63
	2.8 dTi	2799	84	07.1998	10.2001	S9W 702	4	G 62
MASTER III Bus (JD)	2.5 dCi	2464	84	01.2004			4	G 63
	2.5 dCi	2464	74	08.2006		G9U 754	4	G 63
	2.5 dCi	2464	88	08.2006		G9U 650	4	G 63
	2.5 dCi	2464	107	08.2006		G9U 632	4	G 63
	2.5 dCi 100 (JDCV)	2463	73	10.2003		G9U 754	4	G 63
MASTER III Bus (JV)	NEW 2.3 dCi 100 FWD (JVOA, JVOB)	2298	74	02.2011		OE : 110651492R	4	GPE 93
	NEW 2.3 dCi 110 FWD	2298	81	09.2014		OE : 110651492R	4	GPE 93
	NEW 2.3 dCi 125 FWD (JQVC, JQVD, JQVH)	2298	92	02.2011		OE : 110651492R	4	GPE 93
	NEW 2.3 dCi 135 FWD	2298	100	07.2014		OE : 110651492R	4	GPE 93
	NEW 2.3 dCi 145 FWD (JVOF, JVOH)	2298	107	02.2011		OE : 110651492R	4	GPE 93
	NEW 2.3 dCi 150 FWD	2298	110	10.2012		OE : 110651492R	4	GPE 93
	NEW 2.3 dCi 165 FWD	2298	120	07.2014		OE : 110651492R	4	GPE 93

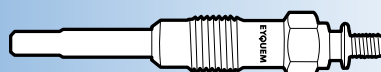



kW



Cyl.



RENAULT

MASTER III Camionnette (FV)	NEW 2.3 dCi 100 FWD (FVOA, FVOB, FVOG, FVOK)	2298	74	02.2010		OE : 110651492R	4	GPE 93
	NEW 2.3 dCi 100 RWD (FVOB, FVOC, FVOD)	2298	74	02.2010		OE : 110651492R	4	GPE 93
	NEW 2.3 dCi 110 FWD	2298	81	09.2014		OE : 110651492R	4	GPE 93
	NEW 2.3 dCi 125 FWD (FVOC, FVOD)	2298	92	02.2010		OE : 110651492R	4	GPE 93
	NEW 2.3 dCi 125 RWD (FVOC, FVOD, FVOH, FVOJ)	2298	92	02.2010		OE : 110651492R	4	GPE 93
	NEW 2.3 dCi 135 FWD	2298	100	07.2014		OE : 110651492R	4	GPE 93
	NEW 2.3 dCi 135 RWD	2298	100	07.2014		OE : 110651492R	4	GPE 93
	NEW 2.3 dCi 145 FWD (FVOE, FVOF, FVOH, FVOJ)	2298	107	02.2010		OE : 110651492R	4	GPE 93
	NEW 2.3 dCi 145 RWD (FVOE, FVOF, FVOJ)	2298	107	02.2010		OE : 110651492R	4	GPE 93
	NEW 2.3 dCi 150 FWD	2298	110	03.2013		OE : 110651492R	4	GPE 93
	NEW 2.3 dCi 150 RWD	2298	110	03.2013		OE : 110651492R	4	GPE 93
	NEW 2.3 dCi 165 FWD	2298	120	07.2014		OE : 110651492R	4	GPE 93
	NEW 2.3 dCi 165 RWD	2298	120	07.2014		OE : 110651492R	4	GPE 93
MASTER III Camionnette (HD, FD)	2.5 dCi	2464	84	01.2004			4	G 63
	2.5 dCi	2464	74	08.2006		G9U 754	4	G 63
	2.5 dCi	2464	88	08.2006		G9U 650	4	G 63
	2.5 dCi	2464	107	08.2006		G9U 632	4	G 63
	2.5 dCi 100 (HDOU, FDOU, HDOV, FDOV)	2463	73	10.2003		G9U 754	4	G 63
MASTER III Camion/ Plate-forme (ED, UD)	2.5 dCi	2464	84	01.2004			4	G 63
	2.5 dCi	2464	74	08.2006		G9U 754	4	G 63
	2.5 dCi	2464	88	08.2006		G9U 650	4	G 63
	2.5 dCi	2464	107	08.2006		G9U 632	4	G 63
	2.5 dCi 100 (ED4V, ED8V)	2463	73	10.2003		G9U 754	4	G 63
MASTER III Camion/ Plate-forme (EV, HV, UV)	NEW 2.3 dCi 100 FWD (EVOA, EVOB, HVOA, HVOB,...)	2298	74	02.2010		OE : 110651492R	4	GPE 93
	NEW 2.3 dCi 100 RWD (UVOC, UVOD, HVOC, HVOD)	2298	74	02.2010		OE : 110651492R	4	GPE 93
	NEW 2.3 dCi 110 FWD	2298	81	09.2014		OE : 110651492R	4	GPE 93
	NEW 2.3 dCi 125 FWD (EVOC, EVOD, EVOJ, HVOC,...)	2298	92	02.2010		OE : 110651492R	4	GPE 93
	NEW 2.3 dCi 125 RWD (HVOC, HVOD, UVOC, UVOD)	2298	92	02.2010		OE : 110651492R	4	GPE 93
	NEW 2.3 dCi 135 RWD	2298	100	07.2014		OE : 110651492R	4	GPE 93
	NEW 2.3 dCi 145 FWD (EVOE, EVOF, HVOE, HVOF,...)	2298	107	02.2010		OE : 110651492R	4	GPE 93
	NEW 2.3 dCi 145 RWD (UVOF, UVOE)	2298	107	02.2010		OE : 110651492R	4	GPE 93
	NEW 2.3 dCi 150 FWD	2298	110	03.2013		OE : 110651492R	4	GPE 93
	NEW 2.3 dCi 150 RWD	2298	110	03.2013		OE : 110651492R	4	GPE 93
	NEW 2.3 dCi 165 RWD	2298	120	07.2014		OE : 110651492R	4	GPE 93
MEGANE I (BA0/1_)	1.9 D Eco	1870	47	01.1996	08.2003	F8Q 620-624	4	G 50
	1.9 dTi	1870	59	02.2001	08.2003	F9Q 744	4	G 28
	1.9 dTi	1870	60	02.2000	09.2000	F9Q 730	4	G 51
	1.9 dTi	1870	60	02.2000	09.2000	F9Q 730	4	G 28
	1.9 dT	1870	66	01.1996	08.2003	F8Q 784-786	4	G 49
	1.9 TDI	1870	69	09.1996	08.2003	F8Q 784	4	G 49
	1.9 D	1870	69	10.1996	02.2001	F8Q 784	4	G 49
	1.9 dTi	1870	72	03.1997	02.2001	F9Q 730-731-734-736	4	G 28
	1.9 dTi	1870	72	03.1997	02.2001	F9Q 730-731-734-736	4	G 51
	1.9 dCi	1870	75	02.2001	08.2003	F9Q 732-733	4	G 28
MEGANE I Classic (LA0/1_)	1.9 D	1870	47	09.1996	08.2003	F8Q 620-624	4	G 50
	1.9 dTi	1870	59	02.2001	08.2003	F9Q 744	4	G 28
	1.9 dT	1870	66	09.1996	08.2003	F8Q 784-786	4	G 49
	1.9 TDI	1870	69	09.1996	08.2003	F8Q 784	4	G 49
	1.9 dTi	1870	72	03.1997	02.2001	F9Q 730-731-734-736	4	G 28
	1.9 dTi	1870	72	03.1997	02.2001	F9Q 730-731-734-736	4	G 51
	1.9 dCi	1870	75	02.2001	08.2003	F9Q 732-733-738	4	G 28
	1.9 dCi	1870	75	02.2001	08.2003	F9Q 732-733-738	4	G 51
MEGANE I Coach (DA0/1_)	1.9 dTi	1870	72	03.1997	02.2001	F9Q 731-734-736	4	G 28
	1.9 dTi	1870	72	03.1997	02.2001	F9Q 731-734-736	4	G 51
	1.9 dCi	1870	75	02.2001	08.2003	F9Q 732-733	4	G 28





kW



Cyl.



RENAULT

	1.9 dCi	1870	75	02.2001	08.2003	F9Q 732-733	4	G 51	
MEGANE I Grandtour (KA0/1_)	1.9 D	1870	47	04.1999	08.2003	F8Q 622-790	4	G 29	
	1.9 dTi	1870	59	02.2001	08.2003	F9Q 744	4	G 28	
	1.9 dTi	1870	72	03.1999	02.2001	F9Q 731-736	4	G 28	
	1.9 dTi	1870	72	03.1999	02.2001	F9Q 731-736	4	G 51	
	1.9 dCi	1870	75	02.2001	08.2003	F9Q 732-733-738	4	G 28	
MEGANE II (BMO/1_ CMO/1_)	1.9 dCi	1870	75	02.2001	08.2003	F9Q 732-733-738	4	G 51	
	1.5 dCi	1461	60	11.2002		K9K 722	4	G 28	
	1.5 dCi	1461	63	05.2005	02.2008	K9K 724	4	G 28	
	1.5 dCi	1461	74	10.2003	03.2006	K9K 728-729	4	G 28	
	1.5 dCi	1461	76	01.2007	02.2008	K9K 734	4	G 28	
	1.5 dCi	1461	78	05.2005	06.2008	K9K 732-734	4	G 28	
	1.9 dCi	1870	66	11.2002	12.2005	F9Q 808	4	G 28	
	1.9 dCi	1870	68	03.2004	08.2006	F9Q 808	4	G 28	
	1.9 dCi	1870	81	05.2005	02.2008	F9Q 804-818	4	G 28	
	1.9 dCi	1870	85	11.2002	02.2008	F9Q 804-816-818	4	G 28	
	1.9 dCi	1870	88	11.2002	02.2008	F9Q 800	4	G 28	
	1.9 dCi	1870	96	05.2005	12.2009	F9Q 803-804-816-818	4	G 28	
	MEGANE II Coupé-Cabriolet (EMO/1_)	1.5 dCi	1461	63	05.2005		K9K 724	4	G 28
1.5 dCi		1461	76	01.2007	06.2009	K9K 734	4	G 28	
1.5 dCi		1461	78	03.2006	06.2008	K9K 732	4	G 28	
1.9 dCi		1870	81	05.2005	03.2009	F9Q 804-816-818	4	G 28	
1.9 dCi		1870	85	09.2003	03.2009	F9Q 804-816-818	4	G 28	
1.9 dCi		1870	88	09.2003	03.2009	F9Q 800	4	G 28	
1.9 dCi		1870	96	05.2005	02.2007	F9Q 803-804	4	G 28	
1.5 dCi		1461	60	08.2003	05.2006	K9K 722	4	G 28	
1.5 dCi		1461	63	05.2005	07.2009	K9K 724	4	G 28	
1.5 dCi		1461	74	02.2004	03.2006	K9K 728-729	4	G 28	
MEGANE II Kombi (KMO/1_)	1.5 dCi	1461	76	01.2007	07.2009	K9K 728	4	G 28	
	1.5 dCi	1461	78	05.2005	06.2008	K9K 732-734	4	G 28	
	1.9 dCi	1870	66	04.2004	12.2005	F9Q 808	4	G 28	
	1.9 dCi	1870	68	03.2004	02.2007	F9Q 808	4	G 28	
	1.9 dCi	1870	81	05.2005	07.2009	F9Q 804-818	4	G 28	
	1.9 dCi	1870	85	05.2005	07.2009	F9Q 818	4	G 28	
	1.9 dCi	1870	88	08.2003	07.2009	F9Q 800	4	G 28	
	1.9 dCi	1870	96	05.2005	07.2009	F9Q 803-804	4	G 28	
	1.5 dCi	1461	60	09.2003		K9K 722	4	G 28	
	1.5 dCi	1461	63	05.2005		K9K 724	4	G 28	
	1.5 dCi	1461	74	02.2004		K9K 728-729	4	G 28	
	1.5 dCi	1461	76	01.2007		K9K 734	4	G 28	
	1.5 dCi	1461	78	05.2005		K9K 732	4	G 28	
	1.9 dCi	1870	66	09.2003	12.2005	F9Q 808	4	G 28	
MEGANE II Tricorps (LMO/1_)	1.9 dCi	1870	68	03.2004		F9Q 808	4	G 28	
	1.9 dCi	1870	81	05.2005		F9Q 803-804-816-818	4	G 28	
	1.9 dCi	1870	88	09.2003		F9Q 800	4	G 28	
	1.9 dCi	1870	96	05.2005		F9Q 803-804	4	G 28	
	1.5 dCi	1461	63	12.2009		K9K 830	4	GPE 78	
	1.5 dCi	1461	66	11.2008		K9K H 834	4	GPE 78	
	1.5 dCi	1461	70	11.2013		K9K 846	4	GPE 78	
	1.5 dCi	1461	78	02.2009		K9K G 832	4	GPE 78	
	1.5 dCi	1461	81	02.2009		K9K 636-656-657-836-837-846	4	GPE 78	
	1.6 dCi (BZ00, BZ12)	1598	96	04.2011		R9M 402-404	4	GPE 93	
	1.9 dCi	1970	96	11.2008		F9Q 870-872	4	GPE 79	
	MEGANE III Coupé (DZO/1_)	1.5 dCi	1461	63	11.2008		K9K 830	4	GPE 78
		1.5 dCi	1461	66	11.2008		K9K H 834	4	GPE 78
		1.5 dCi	1461	70	07.2014		K9K 846	4	GPE 78
		1.5 dCi	1461	78	02.2009		K9K 832-K9K G 832	4	GPE 78
1.5 dCi		1461	81	02.2009		K9K 636-J 836-837-846	4	GPE 78	
1.6 dCi (DZ00)		1598	96	04.2011		R9M 402	4	GPE 93	
1.9 dCi		1970	96	11.2008		F9Q 870-872	4	GPE 79	
MEGANE III Grandtour (KZO/1_)		1.5 dCi	1461	63	03.2009		K9K 830	4	GPE 78
	1.5 dCi	1461	66	05.2009		K9K 834	4	GPE 78	
	1.5 dCi	1461	70	11.2013		K9K 846	4	GPE 78	
	1.5 dCi	1461	78	02.2009		K9K 836-846	4	GPE 78	
	1.5 dCi	1461	81	02.2009		K9K 636-836-837-846	4	GPE 78	

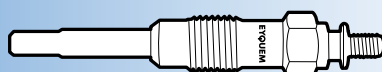



kW



Cyl.



RENAULT

	NEW	1.6 dCi (KZ00, KZ12)	1598	96	04.2011		R9M 402-404	4	GPE 93
	NEW	1.9 dCi	1970	96	05.2009		F9Q 870-872	4	GPE 79
MEGANE III CC (EZ0/1_)	NEW	1.5 dCi	1461	81	06.2010		K9K 837	4	GPE 78
	NEW	1.9 dCi	1970	96	06.2010		F9Q 870	4	GPE 79
	NEW	1.6 dCi (EZ00)	1598	96	04.2011		R9M 402	4	GPE 93
MEGANE IV (B9A/M_)	NEW	1.5 dCi 90	1461	66	11.2015		K9K 656	4	GPE 78
	NEW	1.5 dCi 110	1461	81	11.2015		K9K 646-656-657	4	GPE 78
	NEW	1.6 dCi 130 (B9A4)	1598	96	11.2015		R9M 409	4	GPE 93
	NEW	1.6 dCi 165	1598	120	11.2015		R9M 452	4	GPE 93
MEGANE IV Grandtour (K9A/M_)	NEW	1.5 dCi 90	1461	66	04.2016		K9K 656	4	GPE 78
	NEW	1.5 dCi 110	1461	81	04.2016		K9K 656-657	4	GPE 78
	NEW	1.6 dCi 130	1598	96	04.2016		R9M 409	4	GPE 93
	NEW	1.6 dCi 165	1598	120	04.2016		R9M 452	4	GPE 93
MEGANE Scenic (JA0/1_)		1.9 D	1870	47	03.1997	09.1999	F8Q 790	4	G 54
		1.9 dT	1870	66	01.1997	09.1999	F8Q 784-786	4	G 49
		1.9 dTi	1870	72	04.1997	09.1999	F9Q 730-734	4	G 51
MODUS / GRAND MODUS (F/JPO_)		1.5 dCi	1461	48	12.2004		K9K 752	4	G 28
		1.5 dCi	1461	50	12.2004		K9K 762-768	4	G 28
		1.5 dCi	1461	60	09.2004		K9K 750	4	G 28
		1.5 dCi	1461	63	12.2004		K9K 760-766	4	G 28
		1.5 dCi	1461	76	05.2007		K9K 772	4	G 28
		1.5 dCi	1461	78	05.2005		K9K 764	4	G 28
		1.5 dCi 75	1461	55	10.2010		K9K 770	4	G 28
		1.5 dCi 90	1461	65	10.2010		K9K 750	4	G 28
SAFRANE I (B54_)		2.1 dT	2068	65	11.1993	07.1996	J8S 760	4	G 41
		2.5 dT	2500	83	12.1992	07.1996	S8U 762-763	4	G 41
SAFRANE II (B54_)		2.2 dT	2188	83	07.1996	12.2000	G8T 740	4	G 51
SCÉNIC I (JA0/1_)		1.9 D	1870	47	09.1999	03.2001	F8Q 790	4	G 29
		1.9 dTi	1870	59	02.2001	08.2003	F9Q 744	4	G 28
		1.9 dTi	1870	72	09.1999	08.2003	F9Q 731-734-736	4	G 28
		1.9 dTi	1870	72	09.1999	08.2003	F9Q 731-734-736	4	G 51
		1.9 dCi RX4	1870	74	12.2002	08.2003	F9Q 732-748-796	4	G 28
		1.9 dCi	1870	75	09.1999	08.2003	F9Q 732-733	4	G 28
		1.9 dCi RX4	1870	75	11.2000	08.2003	F9Q 740	4	G 28
SCÉNIC II (JMO/1_)		1.5 dCi	1461	60	06.2003		K9K 722	4	G 28
		1.5 dCi	1461	63	05.2005		K9K 724	4	G 28
		1.5 dCi	1461	74	11.2003		K9K 728-729	4	G 28
		1.5 dCi	1461	76	01.2007		K9K 734	4	G 28
		1.5 dCi	1461	78	05.2005		K9K 732	4	G 28
		1.9 dCi	1870	81	05.2005		F9Q 804	4	G 28
		1.9 D	1870	85	06.2006		F9Q J 803- F9Q 812	4	G 28
		1.9 dCi	1870	88	06.2003		F9Q 812	4	G 28
		1.9 dCi	1870	92	06.2003		F9Q 804	4	G 28
		1.9 dCi	1870	96	05.2005		F9Q J 803- F9Q 804-816-818	4	G 28
SCÉNIC III (JZ0/1_)	NEW	1.5 dCi	1461	63	04.2009		K9K 830	4	GPE 78
	NEW	1.5 dCi	1461	70	11.2010		K9K 846	4	GPE 78
	NEW	1.5 dCi	1461	78	02.2009		K9K 832	4	GPE 78
	NEW	1.5 dCi	1461	81	04.2009		K9K 636-656-657-836-837-K9K J 836-K9K N 837	4	GPE 78
	NEW	1.6 dCi (JZ00, JZ12)	1598	96	04.2011		R9M 402-404-414	4	GPE 93
	NEW	1.9 dCi	1970	96	02.2009		F9Q 870-872	4	GPE 79
SCÉNIC IV (J9_)	NEW	1.5 dCi 95	1461	70	04.2016		K9K 646-K9K 846	4	GPE 78
	NEW	1.5 dCi 110	1461	81	04.2016		K9K 646-647	4	GPE 78
	NEW	1.5 dCi 110 Hybrid Assist	1461	81	04.2017		K9K 500	4	GPE 78
	NEW	1.6 dCi 130	1598	96	09.2016		R9M 409	4	GPE 93
	NEW	1.6 dCi 160	1598	118	09.2016		R9M 452	4	GPE 93
SUPER 5 (B/C40_)		1.6 D	1596	40	08.1985	12.1996	F8M 720-730	4	G 27
		1.6 D	1595	40	04.1985	12.1990	F8M 730	4	G 41
SUPER 5 Kasten (S40_)		1.6 D	1595	40	10.1984	12.1996	F8M 720	4	G 27
TALISMAN (L2M_)	NEW	1.5 dCi 110	1461	81	11.2015		K9K 646-647	4	GPE 78
	NEW	1.6 dCi 130	1598	96	11.2015		R9M 409	4	GPE 93
	NEW	1.6 dCi 160	1598	118	06.2016		R9M 452 -453	4	GPE 93
TALISMAN Grandtour (KP_)	NEW	1.5 dCi 110	1461	81	03.2016		K9K 646-647	4	GPE 78
	NEW	1.6 dCi 130	1598	96	03.2016		R9M 409	4	GPE 93
	NEW	1.6 dCi 160	1598	118	03.2016		R9M 452 -453	4	GPE 93
THALIA I (LB0/1/2_)		1.5 dCi	1461	47	06.2005		K9K 740	4	G 28

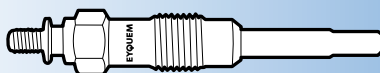



kW



Cyl.



RENAULT

	1.5 dCi	1461	48	04.2002		K9K 700	4	G 28
	1.5 dCi	1461	50	02.2003		K9K 700-714	4	G 28
	1.5 dCi	1461	60	06.2001		K9K 702	4	G 28
THALIA II (LU1/2_)	1.5 dCi	1461	48	01.2009		K9K 700	4	G 28
	1.5 dCi	1461	62	09.2008		K9K 718	4	G 28
TRAFIC Bus (T5, T6, T7)	2.1 D	2068	43	03.1980	04.1989	852 750	4	G 41
	2.1 D 4x4	2068	43	05.1985	02.1989	852 750	4	G 41
	2.5 D	2068	56	03.1989	08.1994	S8U 750	4	G 41
TRAFIC Bus (TXW)	1.9 D	1870	44	06.1997	03.2001	F8Q 606	4	G 54
	2.1 D	2068	43	05.1989	06.1994	852 720-750	4	G 41
	2.1 D	2068	47	06.1994	10.1997	J8S 620-758	4	G 41
	2.5 D	2499	55	05.1989	03.2001	S8U 750-752- 8140.67.2550-2500-2580	4	G 41
	2.5 D	2499	55	05.1989	03.2001	S8U 758	4	G 35
	2.5 D 4x4	2499	55	08.1989	03.2001	S8U 750-752- 8140.67.2550-2500-2580	4	G 41
TRAFIC Camionette (T1, T3, T4)	2.5 D 4x4	2499	55	08.1989	03.2001	S8U 758	4	G 35
	2.1 D	2068	43	09.1980	04.1989	852 750	4	G 41
	2.1 D 4x4	2068	43	11.1986	04.1989	852 750	4	G 41
	2.5 D	2068	56	03.1989	08.1994	S8U 750	4	G 41
TRAFIC Camionette (TXX)	1.9 D	1870	44	06.1997	03.2001	F8Q 606	4	G 54
	2.1 D	2068	43	05.1989	06.1994	852 750	4	G 41
	2.1 D	2068	47	06.1994	10.1997	J8S 620-758	4	G 41
	2.5 D	2499	55	05.1989	03.2001	S8U 750-752- 8140.67.2550-2500-2580	4	G 41
	2.5 D	2499	55	05.1989	03.2001	S8U 758	4	G 35
	2.5 D 4x4	2499	55	05.1989	03.2001	S8U 750-752- 8140.67.2500-2580	4	G 41
TRAFIC Camion/Plate-forme (P6)	2.5 D	2499	56	03.1989	08.1994	S8U 750	4	G 41
	2.1 D	2068	43	03.1980	04.1989	852 720	4	G 41
	2.1 D	2068	43	07.1980	04.1985	852 750	4	G 41
	2.1 D 4x4	2068	43	05.1985	02.1989	852 750	4	G 41
	2.1 D	2068	44	05.1985	02.1989	J8S 750	4	G 41
	2.5 D	2445	51	03.1980	04.1989	8140.61.240- S8U 720-722	4	G 41
TRAFIC Camion/Plate-forme (PXX)	2.1 D	2068	43	05.1989	06.1994	852 720	4	G 41
	2.1 D	2068	47	06.1994	10.1997	J8S 620-758	4	G 41
	2.5 D	2445	51	05.1989	03.2001	S8U 720-722 - 8140.61.240	4	G 41
	2.5 D	2499	55	05.1998	03.2001	S8U 758-780	4	G 35
	2.5 D	2499	56	03.1989	08.1994	S8U 750	4	G 41
	2.5 D, 4x4	2499	58	09.1994	04.1998	S8U 758	4	G 35
TRAFIC II Bus (JL)	1.9 dCi	1870	59	04.2001	07.2003	F9Q 762	4	G 28
	1.9 dCi 80	1870	60	03.2001		F9Q 762	4	G 28
	1.9 dCi 100	1870	74	03.2001		F9Q 760	4	G 28
	NEW 2.0 dCi 90 (JLOH)	1995	66	01.2012		M9R 630 (OE : 110651749R)	4	GPE 93
	NEW 2.0 dCi 115 (JLOH)	1995	84	01.2012		M9R 692 (OE : 110651749R)	4	GPE 93
	2.5 dCi 115	2464	84	02.2008		G9U 630	4	G 63
	2.5 dCi 135	2464	99	05.2003		G9U 730	4	G 63
	2.5 dCi 145	2464	107	08.2006		G9U 630	4	G 63
TRAFIC II Camionette (FL)	1.9 dCi	1870	60	04.2001	07.2003	F9Q 762	4	G 28
	1.9 dCi 80	1870	60	03.2001		F9Q 760-762	4	G 28
	1.9 dCi 100	1870	74	03.2001		F9Q 760	4	G 28
	NEW 2.0 dCi 90 (FLOH)	1995	66	01.2012		OE : 110651749R	4	GPE 93
	NEW 2.0 dCi 115 (FLO1, FLOU)	1995	84	01.2012		M9R 692 (OE : 110651749R)	4	GPE 93
	2.5 dCi 135	2464	99	05.2003		G9U 730	4	G 63
	2.5 dCi 145	2464	107	08.2006		G9U 630	4	G 63
TRAFIC II Camion/Plate-forme (EL)	1.9 dCi	1870	59	09.2001	07.2003	F9Q 762	4	G 28
	1.9 dCi 80	1870	60	03.2001		F9Q 762	4	G 28
	1.9 dCi 100	1870	74	03.2001		F9Q 760	4	G 28
	NEW 2.0 dCi 90 (ELOH)	1995	66	01.2012		M9R 630 (OE : 110651749R)	4	GPE 93
	NEW 2.0 dCi 115 (ELOH)	1995	84	01.2012		M9R 692 (OE : 110651749R)	4	GPE 93
	2.5 dCi	2463	84	08.2007		G9U 630	4	G 63
	2.5 dCi 135	2463	99	03.2001		G9U 730	4	G 63
	2.5 dCi 145	2464	107	08.2006		G9U 630	4	G 63
TRAFIC III Bus (JG_)	NEW 1.6 dCi 90	1598	66	05.2014		R9M 408	4	GPE 93
	NEW 1.6 dCi 95	1598	70	07.2015		R9M 413	4	GPE 93
	NEW 1.6 dCi 115	1598	85	05.2014		R9M 408	4	GPE 93
	NEW 1.6 dCi 120	1598	88	05.2014		R9M 450	4	GPE 93
	NEW 1.6 dCi 125	1598	92	08.2015		R9M 452	4	GPE 93
	NEW 1.6 dCi 140	1598	103	05.2014		R9M 450	4	GPE 93





kW



Cyl.



RENAULT

	NEW	1.6 dCi 145	1598	107	08.2015		R9M 452	4	GPE 93
TRAFIC III Camion/ Plate-forme (EG_)	NEW	1.6 dCi 120	1598	88	06.2014		R9M 450	4	GPE 93
	NEW	1.6 dCi 125	1598	92	07.2015		R9M 452	4	GPE 93
	NEW	1.6 dCi 140	1598	103	06.2014		R9M 450	4	GPE 93
	NEW	1.6 dCi 145	1598	107	07.2015		R9M 452	4	GPE 93
TRAFIC III Camionnette (FG_)	NEW	1.6 dCi 90	1598	66	05.2014		R9M 408	4	GPE 93
	NEW	1.6 dCi 95	1598	70	07.2015		R9M 413	4	GPE 93
	NEW	1.6 dCi 115	1598	85	05.2014		R9M 408	4	GPE 93
	NEW	1.6 dCi 120	1598	88	05.2014		R9M 450	4	GPE 93
	NEW	1.6 dCi 125	1598	92	07.2015		R9M 452	4	GPE 93
	NEW	1.6 dCi 140	1598	103	05.2014		R9M 450	4	GPE 93
	NEW	1.6 dCi 145	1598	107	08.2015		R9M 452	4	GPE 93
TWINGO I (CNO_)		1.5 dCi	1461	47	03.2007		K9K 740	4	G 28
		1.5 dCi	1461	62	04.2008		K9K 718	4	G 28
TWINGO II (CNO)		1.5 dCi	1461	47	03.2007		K9K 740	4	G 28
		1.5 dCi 75	1461	55	10.2010		K9K 820	4	G 28
	NEW	1.5 dCi 75	1461	55	10.2010		K9K 820	4	GPE 78
		1.5 dCi	1461	62	04.2008		K9K 718	4	G 28
	NEW	1.5 dCi 90	1461	63	10.2010		K9K 820	4	G 28
	NEW	1.5 dCi 90	1461	63	10.2010		K9K 820	4	GPE 78
VEL SATIS (BJO_)		2.2 dCi	2188	83	12.2004		G9T 600	4	G 63
		2.2 dCi	2188	85	04.2004		G9T 600	4	G 63
		2.2 dCi	2188	103	09.2004		G9T 600-606-700-702	4	G 63
		2.2 dCi	2188	110	06.2002		G9T 702-703	4	G 63
MASCOTT Camionnette/Kombi		150.35 (A02300161)	2798	107	10.2001	06.2004	8140.43N.3585	4	G 62
		150.55 (A02300164)	2798	107	10.2001	06.2004	8140.43N.3585	4	G 62
		150.65 (A00300166)	2798	107	10.2001	06.2004	8140.43N.3585	4	G 62
MASCOTT Camion/Plate-forme		150.35 (A00300161)	2798	107	10.2001	06.2004	8140.43N.3585	4	G 62
		150.35 (A00300164)	2798	107	10.2001	06.2004	8140.43N.3585	4	G 62

ROVER

100 (METRO) (XP)		114 D	1361	38	10.1992	12.1994	TUD 3	4	G 35
		114 D	1361	38	10.1992	12.1994	TUD 3	4	G 35
		114 D	1361	38	10.1992	12.1994	TUD 3	4	G 35
		115 D	1527	42	12.1994	12.1998	TUD 5	4	G 34
		115 D	1527	42	12.1994	12.1998	TUD 5	4	G 34
		115 D	1527	42	12.1994	12.1998	TUD 5	4	G 34
200 (RF)		220 D/SD	1994	63	11.1995	03.2000	20 T2R	4	G 36
		220 SDi	1994	77	11.1995	03.2000	20 T2N	4	G 36
200 Hatchback (XW)		218 D	1905	52	09.1991	10.1995		4	G 41
		218 D	1905	52	09.1991	10.1995		4	G 41
		218 D	1905	52	09.1991	10.1995		4	G 41
		218 TD	1769	65	09.1991	10.1995	XUD 7TE	4	G 41
		218 TD	1769	65	09.1991	10.1995	XUD 7TE	4	G 41
2000-3500 Hatchback (SD1)		2400 TD	2393	67	05.1982	10.1986	HR 492 HT	4	G 2
25 (RF)		2.0 iDT	1994	74	10.1999		20 T2N	4	G 36
400 (RT)		420 D	1994	63	11.1995	03.2000	20 T2R	4	G 36
		420 Di	1994	77	05.1995	03.2000	20 T2N	4	G 36
400 (XW)		418 D	1905	49	09.1991	04.1995		4	G 41
		418 D	1905	49	09.1991	04.1995		4	G 41
		418 D	1905	49	09.1991	04.1995		4	G 41
		418 TD	1769	65	09.1991	04.1995	XUD 7TE	4	G 41
		418 TD	1769	65	09.1991	04.1995	XUD 7TE	4	G 41
400 Hatchback (RT)		420 D	1994	63	11.1995	03.2000	20 T2R	4	G 36
		420 Di	1994	77	05.1995	03.2000	20 T2N	4	G 36
400 Tourer (XW)		1.8 TD	1769	65	09.1993	11.1998	XUD 7TE	4	G 41
		1.8 TD	1769	65	09.1993	11.1998	XUD 7TE	4	G 41
		1.8 TD	1769	65	09.1993	11.1998	XUD 7TE	4	G 41
45 (RT)		2.0 iDT	1994	74	02.2000	05.2005	20 T2N	4	G 36
45 Tricorps (RT)		2.0 iDT	1994	74	02.2000		20 T2N	4	G 36
600 (RH)		620 Sdi	1994	77	12.1994	02.1999	20 T2N	4	G 36
75 (R.J)		2.0 CDT	1950	85	02.1999		M 47 R	4	G 23
		2.0 CDTi	1951	96	02.2003		204D2	4	G 23
75 Tourer (R.J)		2.0 CDT	1950	85	08.2001		M 47 R	4	G 23





kW



Cyl.



ROVER

	2.0 CDTi	1951	96	02.2003		204D2	4	G 23
800 (XS)	825 D/SD (XS)	2500	87	01.1990	02.1999	425 SL1RR/492 4 SHIRG	4	G 40
	825 D/SD (XS)	2500	87	01.1990	02.1999	425 SL1RR/492 4 SHIRG	4	G 41
800 Coupe	825 SD	2500	87	09.1993	02.1999	425 SL1RR/492 4 SHIRG	4	G 40
	825 SD	2500	87	09.1993	02.1999	425 SL1RR/492 4 SHIRG	4	G 41
800 Hatchback (XS)	825 D/SD (XS)	2500	87	01.1992	02.1999	425 SL1RR/492 4 SHIRG	4	G 40
	825 D/SD (XS)	2500	87	01.1992	02.1999	425 SL1RR/492 4 SHIRG	4	G 41
MAESTRO	2.0 D	1994	44	09.1990	10.1992		4	G 41
	2.0 D	1994	44	09.1990	10.1992		4	G 41
	2.0 D	1994	44	09.1990	10.1992		4	G 41
	2.0 TD	1994	60	09.1990	01.1995	BB	4	G 41
	2.0 TD	1994	60	09.1990	01.1995	BB	4	G 41
	2.0 TD	1994	60	09.1990	01.1995	BB	4	G 41
MONTEGO	2.0 D Turbo	1996	60	10.1988	10.1995	BB	4	G 41
	2.0 D Turbo	1996	60	10.1988	10.1995	BB	4	G 41
	2.0 D Turbo	1996	60	10.1988	10.1995	BB	4	G 41
MONTEGO Estate (XE)	2.0 Turbo-D	1996	60	01.1993	12.1993	BB	4	G 41
	2.0 Turbo-D	1996	60	01.1993	12.1993	BB	4	G 41

SAAB

9-3 (YS3D)	2.2 TiD	2171	92	11.2000	09.2002	D223L	4	G 3
	2.2 TiD	2171	85	02.1998	11.2000	X 22 DTH/D223L	4	G 56
9-3 (YS3F)	1.9 TiD	1910	88	09.2004		Z 19 DT	4	G 60
	NEW 1.9 TiD	1910	88	09.2004		Z 19 DT	4	G 89
	1.9 TiD	1910	110	09.2004		Z 19 DTH	4	G 8
	NEW 1.9 TTiD	1910	96	12.2007		A 19 DTR	4	GPE 82
	NEW 1.9 TTiD	1910	118	12.2007		A 19 DTR	4	GPE 82
	NEW 1.9 TTiD	1910	132	12.2007		A 19 DTR/Z 19 DTR	4	GPE 82
9-3 Cabriolet (YS3F)	2.2 TiD	2171	92	09.2002		D223L	4	G 3
	1.9 TiD	1910	110	01.2006		Z 19 DTH	4	G 8
	NEW 1.9 TiD	1910	88	09.2004		Z 19 DT	4	G 89
	NEW 1.9 TTiD	1910	118	12.2007		A 19 DTR	4	GPE 82
	NEW 1.9 TTiD	1910	132	12.2007		A 19 DTR/Z 19 DTR	4	GPE 82
	9-3 Kombi	1.9 TiD	1910	88	03.2005		Z 19 DT	4
9-3 Kombi	NEW 1.9 TiD	1910	88	03.2005		Z 19 DT	4	G 89
	1.9 TiD	1910	110	03.2005		Z 19 DTH	4	G 8
	NEW 1.9 TTiD	1910	96	12.2007		A 19 DTR	4	GPE 82
	NEW 1.9 TTiD	1910	118	12.2007		A 19 DTR	4	GPE 82
	NEW 1.9 TTiD	1910	132	12.2007		A 19 DTR/Z 19 DTR	4	GPE 82
	NEW 1.9 TTiD	1910	132	02.2009		A 19 DTR/Z 19 DTR	4	GPE 82
9-3X	NEW 1.9 TTiD	1910	132	02.2009		A 19 DTR/Z 19 DTR	4	GPE 82
9-5 (YS3E)	1.9 TiD	1910	110	01.2006		Z 19 DTH	4	G 8
	2.2 TiD	2171	88	03.2002		D223L	4	G 56
9-5 Kombi (YS3E)	1.9 TiD	1910	110	01.2006		Z 19 DTH	4	G 8
	2.2 TiD	2171	88	03.2002		D223L	4	G 56

SEAT

131	2.4 Diesel	2445	53	06.1978	12.1986	8144.61	4	G 41	
132	2.0 D	1988	40	05.1973	12.1980		4	G 41	
	2.0 D	1988	40	05.1973	12.1980		4	G 41	
	2.0 D	1988	40	05.1973	12.1980		4	G 41	
	2.2 D	2197	44	05.1979	12.1982	OM 615.912	4	G 41	
	2.2 D	2197	44	05.1979	12.1982	OM 615.912	4	G 41	
	2.2 D	2197	44	05.1979	12.1982	OM 615.912	4	G 41	
	ALHAMBRA (7V8, 7V9)	1.9 TDI	1896	66	04.1996	03.2010	ANU/1Z/AHU	4	G 37
1.9 TDI		1896	66	04.1996	03.2010	ANU/1Z/AHU (auxiliary heating)	3	G 17	
1.9 TDI		1896	81	08.1996	06.2000	AVG/AFN	4	G 37	
1.9 TDI		1896	81	08.1996	06.2000	AVG/AFN (auxiliary heating)	3	G 17	
1.9 TDI, 4motion		1896	85	06.2000	03.2010	BVK/AUY Nr Chassis ->7M 2 514 000	4	G 37	
1.9 TDI, 4motion		1896	85	06.2000	03.2010	BVK/AUY à partir Chassis Nr 7M 2 514 001	4	G 4	
1.9 TDI, 4motion		1896	85	06.2000	03.2010	BVK/AUY (auxiliary heating)	3	G 17	
1.9 TDI		1896	96	11.2002	11.2008	ASZ	4	G 4	
1.9 TDI		1896	110	05.2005	05.2007	ARL/BTB	4	G 4	
ALHAMBRA (710)		2.0 TDI	1968	85	05.2011		CFFE	4	GPE 74
		2.0 TDI	1968	100	06.2010	05.2011	CFFA	4	GPE 74
	2.0 TDI	1968	103	06.2010		CFFB	4	GPE 74	





kW



Cyl.



SEAT								
	2.0 TDI 4Drive	1968	103	05.2011		CFFB	4	GPE 74
	NEW 2.0 TDI, 4Drive	1968	110	05.2015		CUVC/DFLA	3	GPE 74
	2.0 TDI	1968	125	06.2010		CFGB	4	GPE 74
	2.0 TDI	1968	130	11.2012		CFGC	4	GPE 74
	NEW 2.0 TDI, 4Drive	1968	135	05.2015		CUWA/DFMA	3	GPE 74
ALTEA (5P1)	1.6 TDI	1598	66	11.2010		CAYB	4	GPE 74
	1.6 TDI	1598	77	10.2009		CAYC	4	GPE 74
	1.9 TDI	1896	66	08.2009		BXF	4	GPE 70
	1.9 TDI	1896	77	04.2004		BXE/BKC/BJB/BLS	4	GPE 70
	2.0 TDI	1968	100	03.2004	05.2009	AZV	4	GPE 71
	2.0 TDI	1968	103	11.2005	11.2010	BMM	4	GPE 70
	2.0 TDI 16V	1968	103	03.2004		BKD	4	GPE 71
	2.0 TDI 16V	1968	103	03.2004		CFHC	4	GPE 74
	2.0 TDI	1968	125	03.2006		CEGA	4	GPE 74
ALTEA XL (5P5, 5P8)	1.6 TDI	1598	66	11.2010		CAYB	4	GPE 74
	1.6 TDI	1598	77	10.2009		CAYC	4	GPE 74
	1.9 TDI	1896	66	08.2009		BXF	4	GPE 70
	1.9 TDI	1896	77	10.2006		BXE/BLS	4	GPE 70
	2.0 TDI	1968	100	11.2006	03.2009	AZV	4	GPE 71
	2.0 TDI, 4x4	1968	103	10.2006	11.2010	BMM	4	GPE 70
	2.0 TDI 16V	1968	103	10.2006		BKD	4	GPE 71
	2.0 TDI 16V	1968	103	10.2006		CFHC	4	GPE 74
	2.0 TDI 16V 4x4	1968	103	10.2010		CFHC	4	GPE 74
	2.0 TDI	1968	125	06.2007		CEGA	4	GPE 74
	2.0 TDI 4x4	1968	125	06.2007		CEGA/CFJA	4	GPE 74
ARONA (KJ7)	NEW 1.6 TDI	1598	70	11.2017		DGTD	3	GPE 74
	NEW 1.6 TDI	1598	85	07.2017		DGTA	3	GPE 74
AROSA (6H)	1.4 TDI	1422	55	01.2000	10.2001	AMF	3	G 37
	1.4 TDI	1422	55	11.2001	06.2004	AMF	3	G 4
	1.7 SDI	1716	44	08.1997	06.2004	AKU	4	G 37
ATECA (KH7)	NEW 1.6 TDI	1598	85	04.2016		DDYA	4	GPE 74
	NEW 2.0 TDI	1968	81	10.2016		CRVA	4	GPE 74
	NEW 2.0 TDI, 4Drive	1968	110	04.2016		DFFA	4	GPE 74
	NEW 2.0 TDI 4Drive	1968	140	04.2016		DFHA	3	GPE 74
CORDOBA	1.9 D	1896	66	05.1999	09.2002	AGR/ALH	4	G 17
	1.9 D	1896	81	05.1999	09.2002	ASV	4	G 17
	1.9 D	1896	50	05.1999	09.2002	AQM/AGP	4	G 37
	1.9 D	1896	66	05.1999	09.2002	AGR/ALH	4	G 37
	1.9 D	1896	81	05.1999	09.2002	ASV	4	G 37
CORDOBA (6K1, 6K2)	1.7 SDI	1716	44	07.1997	06.1999		4	G 37
	1.9 D	1896	47	01.1996	08.1996	1Y	4	G 17
	1.9 SDI	1896	47	08.1996	06.1999	AEY	4	G 37
	1.9 SDI	1896	47	08.1996	06.1999	AEY (auxiliary heating)	3	G 17
	1.9 D	1896	50	02.1993	08.1996	1Y	4	G 17
	1.9 TD	1896	55	02.1993	08.1996	AAZ	4	G 17
	1.9 TDI	1896	66	08.1996	06.1999	1Z/AHU	4	G 37
	1.9 TDI	1896	66	08.1996	06.1999	1Z/AHU (auxiliary heating)	3	G 17
	1.9 TDI	1896	81	03.1997	06.1999	AFN	4	G 37
	1.9 TDI	1896	81	03.1997	06.1999	AFN (auxiliary heating)	3	G 17
CORDOBA (6L2)	1.4 TDI	1422	51	05.2005	11.2009	BNM	3	G 4
	1.4 TDI	1422	55	10.2002	12.2005	AMF	3	G 4
	1.4 TDI	1422	59	06.2005	11.2009	BNV	3	G 4
	1.9 SDI	1896	47	09.2002	11.2009	ASY	4	G 37
	1.9 TDI	1896	74	09.2002	11.2009	AXR/ATD	4	G 4
	1.9 TDI	1896	96	10.2002	11.2009	BLT/ASZ	4	G 4
CORDOBA Hatchback	1.9 D	1896	66	07.1996	04.1999	1Z/AHU	4	G 17
	1.9 D	1896	66	07.1996	04.1999	1Z/AHU	4	G 37
CORDOBA Hatchback (6K2)	1.9 SDI	1896	50	06.1999	10.2002	AQM/AGP	4	G 37
	1.9 TDI	1896	66	06.1999	10.2002	AHU/AGR/ALH	4	G 37
	1.9 TDI	1896	66	06.1999	10.2002	AHU/AGR/ALH (auxiliary heating)	3	G 17
	1.9 TDI	1896	81	06.1999	10.2002	ASK/ASV	4	G 37
	1.9 TDI	1896	81	06.1999	10.2002	ASK/ASV (auxiliary heating)	3	G 17
CORDOBA Vario (6K5)	1.7 SDI	1716	44	07.1997	06.1999		4	G 37
	1.9 SDI	1896	47	09.1996	06.1999	AEY	4	G 37
	1.9 SDI	1896	47	09.1996	06.1999	AEY (auxiliary heating)	3	G 17





kW



Cyl.



SEAT

	1.9 SDI	1896	50	06.1999	12.2002	AQM/AGP	4	G 37
	1.9 TDI	1896	66	08.1996	06.1999	1Z/AHU	4	G 37
	1.9 TDI	1896	66	08.1996	06.1999	1Z/AHU (auxiliary heating)	3	G 17
	1.9 TDI	1896	81	07.1997	06.1999	AFN	4	G 37
	1.9 TDI	1896	81	07.1997	06.1999	AFN (auxiliary heating)	3	G 17
EXEO (3R2)	2.0 TDI	1968	88	12.2008		CAGC/CJCC	4	GPE 74
	2.0 TDI	1968	105	03.2009		CAGA/CJCA	4	GPE 74
	2.0 TDI	1968	125	03.2009		CAHA/CGLB	4	GPE 74
EXEO ST (3R5)	2.0 TDI	1968	88	07.2009		CAGC/CJCC	4	GPE 74
	2.0 TDI	1968	105	05.2009		CAGA/CJCA	4	GPE 74
	2.0 TDI	1968	125	06.2009		CAHA/CGLB	4	GPE 74
IBIZA I (021A)	1.7 D	1714	40	06.1984	05.1993	022 A.5000	4	G 41
	1.7 D	1714	42	08.1990	05.1993	022 A.5000	4	G 41
IBIZA II (6K1)	1.9 D	1896	47	04.1993	08.1996	1Y	4	G 17
	1.9 SDI	1896	47	08.1996	08.1999	AEY	4	G 37
	1.9 SDI	1896	47	08.1996	08.1999	AEY (auxiliary heating)	3	G 17
	1.9 D	1896	50	10.1994	08.1996	1Y	4	G 17
	1.9 TD	1896	55	03.1993	08.1996	AAZ	4	G 17
	1.9 TDI	1896	66	08.1996	08.1999	1Z/AHU	4	G 37
	1.9 TDI	1896	66	08.1996	08.1999	1Z/AHU (auxiliary heating)	3	G 17
	1.9 TDI	1896	81	02.1997	08.1999	AFN	4	G 37
	1.9 TDI	1896	81	02.1997	08.1999	AFN (auxiliary heating)	3	G 17
IBIZA III (6K1)	1.9 SDI	1896	50	08.1999	02.2002	AQM/AGP	4	G 37
	1.9 TDI	1896	66	08.1999	02.2002	AGR/ALH	4	G 37
	1.9 TDI	1896	66	08.1999	02.2002	AGR/ALH (auxiliary heating)	3	G 17
	1.9 TDI	1896	81	08.1999	02.2002	ASK/ASV	4	G 37
	1.9 TDI	1896	81	08.1999	02.2002	ASK/ASV (auxiliary heating)	3	G 17
IBIZA IV (6L1)	1.4 TDI	1422	51	05.2005	11.2009	BNM	3	G 4
	1.4 TDI	1422	55	05.2002	12.2005	AMF	3	G 4
	1.4 TDI	1422	59	06.2005	11.2009	BNV	3	G 4
	1.9 SDI	1896	47	02.2002	12.2005	ASY	4	G 37
	1.9 TDI	1896	74	02.2002	11.2009	AXR/ATD	4	G 4
	1.9 TDI	1896	96	02.2002	11.2009	ASZ/BLT	4	G 4
	1.9 TDI Cupra R	1896	118	03.2004	02.2008	BPX/BUK	4	G 4
IBIZA IV (6J5, 6P1)	1.2 TDI	1199	55	05.2010		CFWA	3	GPE 74
	NEW 1.4 TDI	1422	55	05.2015		CUSA	3	GPE 74
	NEW 1.4 TDI	1422	66	05.2015		CUSB	2	GPE 74
	NEW 1.4 TDI	1422	77	05.2015		CUTA	2	GPE 74
	1.6 TDI	1598	66	05.2009		CAYB	4	GPE 74
	1.6 TDI	1598	77	05.2009		CAYC/CLNA	4	GPE 74
	1.9 TDI	1896	77	03.2008	06.2010	BLS	4	GPE 70
	2.0 TDI	1968	105	01.2010		CFHD	4	GPE 74
IBIZA IV SPORTCOUPE (6J1, 6P5)	1.2 TDI	1199	55	05.2010		CFWA	3	GPE 74
	NEW 1.4 TDI	1422	55	05.2015		CUSA	3	GPE 74
	NEW 1.4 TDI	1422	66	05.2015		CUSB	2	GPE 74
	NEW 1.4 TDI	1422	77	05.2015		CUTA	2	GPE 74
	1.6 TDI	1598	66	05.2009		CAYB	4	GPE 74
	1.6 TDI	1598	77	05.2009		CAYC/CLNA	4	GPE 74
	1.9 TDI	1896	66	07.2008	06.2010	BXJ	4	GPE 70
	1.9 TDI	1896	77	07.2008	06.2010	BLS	4	GPE 70
	2.0 TDI	1968	105	01.2010		CFHD	4	GPE 74
IBIZA IV ST (6J8, 6P8)	NEW 1.2 TDI	1199	55	04.2010		CFWA	3	GPE 74
	NEW 1.4 TDI	1422	55	05.2015		CUSA	3	GPE 74
	NEW 1.4 TDI	1422	66	05.2015		CUSB	2	GPE 74
	NEW 1.4 TDI	1422	77	05.2015		CUTA	2	GPE 74
	1.6 TDI	1598	66	03.2010		CAYB	4	GPE 74
	1.6 TDI	1598	77	03.2010		CAYC/CLNA	4	GPE 74
IBIZA V (KJ1)	NEW 1.6 TDI	1598	59	11.2017		DGTC	3	GPE 74
	NEW 1.6 TDI	1598	70	09.2017		DGTD	3	GPE 74
INCA (6K9)	1.7 D	1716	42	09.1996	06.2003	AHB	4	G 17
	1.9 D	1896	47	11.1995	06.2003	1Y	4	G 17
	1.9 SDI	1896	47	11.1995	06.2003	AYQ/AEY	4	G 37
	1.9 TDI	1896	66	09.1996	06.2003	ALH	4	G 37
	1.9 TDI	1896	66	09.1996	06.2003	ALH (auxiliary heating)	3	G 17
LEON (1M1)	1.9 SDI	1896	50	11.1999	06.2006	AQM	4	G 37

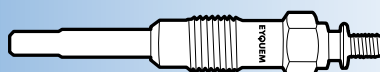



kW



Cyl.



SEAT									
		1.9 TDI	1896	66	11.1999	06.2006	AGR/ALH	4	G 37
		1.9 TDI	1896	66	11.1999	06.2006	AGR/ALH (auxiliary heating)	3	G 17
		1.9 TDI	1896	74	10.2005	06.2006	AXR	4	GPE 70
		1.9 TDI	1896	81	11.1999	06.2006	AHF/ASV	4	G 37
		1.9 TDI	1896	81	11.1999	06.2006	AHF/ASV (auxiliary heating)	3	G 17
		1.9 TDI	1896	96	05.2003	06.2006	ASZ	4	G 4
		1.9 TDI, Syncro	1896	110	02.2001	06.2006	ARL Nr Chassis -> 1M 2 062 000	4	G 37
		1.9 TDI, Syncro	1896	110	02.2001	06.2006	ARL Nr Chassis 1M 2 062 001 ->	4	G 4
		1.9 TDI, Syncro	1896	110	02.2001	06.2006	ARL (auxiliary heating)	3	G 17
LEON (1P1)	NEW	1.6 TDI	1598	66	11.2010	12.2012	CAYB	4	GPE 74
	NEW	1.6 TDI	1598	77	02.2010	12.2012	CAYC	4	GPE 74
		1.9 TDI	1896	66	06.2007	12.2010	BXF	4	GPE 70
		1.9 TDI	1896	77	07.2005	12.2010	BXE/BKC	4	GPE 70
		2.0 TDI	1968	100	07.2005	05.2010	AZV	4	GPE 71
		2.0 TDI	1968	103	10.2005	10.2010	BMM	4	GPE 70
		2.0 TDI 16V	1968	103	07.2005	12.2012	CFHC/CLCB	4	GPE 74
		2.0 TDI 16V	1968	103	07.2005	12.2012	BKD	4	GPE 71
		2.0 TDI	1968	125	05.2006	12.2012	CEGA/CFJA	4	GPE 74
LEON (5F1)		1.6 TDI	1598	66	11.2012		CLHB	4	GPE 74
		1.6 TDI	1598	77	11.2012		CLHA	4	GPE 74
		1.6 TDI	1598	81	09.2013		CRKB/CXXB/DBKA	4	GPE 74
	NEW	1.6 TDI	1598	85	11.2016		DDYA	4	GPE 74
		2.0 TDI	1968	81	05.2013		CRVA	4	GPE 74
		2.0 TDI	1968	105	05.2013		CRVC	4	GPE 74
		2.0 TDI	1968	110	10.2012		CKFC/CRMB	4	GPE 74
		2.0 TDI	1968	135	09.2012		CUNA/CUPA	4	GPE 74
LEON SC (5F5)	NEW	1.6 TDI	1598	66	02.2013		CLHB	4	GPE 74
	NEW	1.6 TDI	1598	77	02.2013		CLHA	4	GPE 74
	NEW	1.6 TDI	1598	81	09.2013		CRKB/CXXB/DBKA	4	GPE 74
	NEW	1.6 TDI	1598	85	11.2016		DDYA	4	GPE 74
	NEW	2.0 TDI	1968	81	02.2013		CRVA	4	GPE 74
	NEW	2.0 TDI	1968	105	05.2013		CRVC	4	GPE 74
	NEW	2.0 TDI	1968	110	02.2013		CKFC/CRMB	4	GPE 74
	NEW	2.0 TDI	1968	135	03.2013		CUNA/CUPA	4	GPE 74
LEON ST (5F8)	NEW	1.6 TDI	1598	66	11.2013		CLHB	4	GPE 74
	NEW	1.6 TDI	1598	77	10.2013		CLHA	4	GPE 74
	NEW	1.6 TDI 4Drive	1598	77	04.2014		CLHA	4	GPE 74
	NEW	1.6 TDI	1598	81	09.2013		CRKB/CXXB/DBKA	4	GPE 74
	NEW	1.6 TDI 4Drive	1598	81	11.2014		CRKB	4	GPE 74
	NEW	1.6 TDI	1598	85	11.2016		DDYA	4	GPE 74
	NEW	2.0 TDI	1968	81	11.2013		CRVA	4	GPE 74
	NEW	2.0 TDI	1968	105	10.2013		CRVC	4	GPE 74
	NEW	2.0 TDI	1968	110	10.2013		CKFC/CRMB	4	GPE 74
	NEW	2.0 TDI 4Drive	1968	110	04.2014		CRLB/CRBC	4	GPE 74
	NEW	2.0 TDI	1968	135	08.2013		CUNA/CUPA	4	GPE 74
	NEW	2.0 TDI 4Drive	1968	135	11.2014		CUNA	4	GPE 74
MALAGA (023A)		1.7 D	1714	40	05.1985	12.1993	022 A.5000	4	G 41
		1.7 D	1714	42	05.1990	12.1993	022 A.5000	4	G 41
RITMO (138)		1.7 D	1714	41	10.1979	09.1983	022 A.5000	4	G 41
RONDA (022A)		1.7 Diesel	1714	40	06.1982	12.1986	022 A.5000	4	G 41
		1.7 Diesel	1714	41	06.1982	12.1986	022 A.5000	4	G 41
TERRA (24)		1.3 D	1272	33	03.1990	12.1994	MN	4	G 17
		1.4 D	1398	35	10.1990	12.1995	1 W	4	G 17
TERRA Camionnette (024A)		1.3 D	1272	33	03.1990	02.1992	MN	4	G 17
		1.4 D	1398	35	10.1990	02.1992	1 W	4	G 17
TOLEDO I (1L)		1.9 D	1896	47	12.1995	03.1999	1Y	4	G 17
		1.9 D	1896	50	05.1991	03.1999	1Y	4	G 17
		1.9 TD	1896	55	05.1991	03.1999	AAZ	4	G 17
		1.9 TDI	1896	66	08.1995	03.1999	1Z/AHU	4	G 37
		1.9 TDI	1896	66	08.1995	03.1999	1Z/AHU (auxiliary heating)	3	G 17
		1.9 TDI	1896	81	11.1996	03.1999	AFN	4	G 37
		1.9 TDI	1896	81	11.1996	03.1999	AFN (auxiliary heating)	3	G 17
TOLEDO II (1M2)		1.9 SDI	1896	50	11.1999	06.2004	AQM	4	G 37
		1.9 TDI	1896	66	04.1999	05.2006	AGR/ALH	4	G 37
		1.9 TDI	1896	66	04.1999	05.2006	AGR/ALH (auxiliary heating)	3	G 17





kW



Cyl.



SEAT

	1.9 TDI	1896	81	04.1999	05.2006	AHF/ASV	4	G 37
	1.9 TDI	1896	81	04.1999	05.2006	AHF/ASV (auxiliary heating)	3	G 17
	1.9 TDI	1896	96	05.2003	05.2006	ASZ	4	G 4
	1.9 TDI	1896	110	10.2000	05.2006	ARL Nr Chassis -> 1M 2 062 000	4	G 37
	1.9 TDI	1896	110	10.2000	05.2006	ARL Nr Chassis 1M 2 062 001 ->	4	G 4
TOLEDO III (5P2)	1.9 TDI	1896	77	10.2004	05.2009	BXE/BKC/BJB	4	GPE 70
	2.0 TDI	1968	100	09.2004	05.2009	AZV	4	GPE 71
	2.0 TDI 16V	1968	103	04.2004	05.2009	BKD	4	GPE 71
	2.0 TDI	1968	125	01.2006	05.2009	CEGA	4	GPE 74
TOLEDO IV (KG3)	NEW 1.4 TDI	1598	66	05.2015		CUSB	2	GPE 74
	1.6 TDI	1598	66	06.2013		CAYB	4	GPE 74
	1.6 TDI	1598	77	07.2012		CAYC/CLNA	4	GPE 74
	NEW 1.6 TDI	1598	85	05.2015		CXMA	3	GPE 74

SKODA

FABIA	1.2 TDI	1199	55	05.2010	12.2014	CFWA	3	GPE 74
	1.4 TDI	1422	51	02.2007	03.2010	BNM	3	G 4
	1.4 TDI	1422	59	01.2007	03.2010	BMS/BNV	3	G 4
	1.6 TDI	1598	55	04.2010	12.2014	CAYA	4	GPE 74
	1.6 TDI	1598	66	03.2010	12.2014	CAYB	4	GPE 74
	1.6 TDI	1598	77	03.2010	12.2014	CAYC	4	GPE 74
	1.9 TDI	1896	77	04.2007	03.2010	BSW/BLS	4	G 4
FABIA (6Y2)	1.4 TDI	1422	51	10.2005	03.2008	BNM	3	G 4
	1.4 TDI	1422	55	04.2003	03.2008	AMF	3	G 4
	1.4 TDI	1422	59	10.2005	03.2008	BNV	3	G 4
	1.9 SDI	1896	47	12.1999	03.2008	ASY	4	G 37
	1.9 TDI	1896	74	01.2000	03.2008	AXR/ATD	4	G 37
	1.9 TDI	1896	74	01.2000	03.2008	AXR/ATD	4	G 4
	1.9 TDI	1896	74	01.2000	03.2008	AXR/ATD (auxiliary heating)	3	G 17
	1.9 TDI RS	1896	96	06.2003	03.2008	BLT/ASZ	4	G 4
FABIA Combi	1.2 TDI	1199	55	05.2010	12.2014	CFWA	3	GPE 74
	1.4 TDI	1422	51	10.2007	03.2010	BNM	3	G 4
	1.4 TDI	1422	59	10.2007	03.2010	BMS/BNV	3	G 4
	1.6 TDI	1598	55	04.2010	12.2014	CAYA	4	GPE 74
	1.6 TDI	1598	66	03.2010	12.2014	CAYB	4	GPE 74
	1.6 TDI	1598	77	03.2010	12.2014	CAYC	4	GPE 74
	1.9 TDI	1896	77	10.2007	03.2010	BSW/BLS	4	G 4
FABIA Combi (6Y5)	1.4 TDI	1422	51	10.2005	12.2007	BNM	3	G 4
	1.4 TDI	1422	55	04.2003	12.2007	AMF	3	G 4
	1.4 TDI	1422	59	10.2005	12.2007	BNV	3	G 4
	1.9 SDI	1896	47	04.2000	12.2007	ASY	4	G 37
	1.9 TDI	1896	74	04.2000	12.2007	AXR/ATD	4	G 37
	1.9 TDI	1896	74	04.2000	12.2007	AXR/ATD	4	G 4
	1.9 TDI	1896	74	04.2000	12.2007	AXR/ATD (auxiliary heating)	3	G 17
FABIA Praktik	1.4 TDI	1422	51	10.2005	12.2007	BNM	3	G 4
	1.9 SDI	1896	47	07.2001	12.2007	ASY	4	G 37
FABIA Tricorps (6Y3)	1.4 TDI	1422	51	10.2005	12.2007	BNM	3	G 4
	1.4 TDI	1422	55	04.2003	12.2007	AMF	3	G 4
	1.4 TDI	1422	59	10.2005	12.2007	BNV	3	G 4
	1.9 SDI	1896	47	11.1999	12.2007	ASY	4	G 37
	1.9 TDI	1896	74	01.2000	12.2007	AXR/ATD	4	G 37
	1.9 TDI	1896	74	01.2000	12.2007	AXR/ATD	4	G 4
	1.9 TDI	1896	74	01.2000	12.2007	AXR/ATD (auxiliary heating)	4	G 17
FABIA III (NJ3)	NEW 1.4 TDI	1422	55	05.2015	05.2016	CUSA	2	GPE 74
	NEW 1.4 TDI	1422	66	08.2014		CUSB	2	GPE 74
	NEW 1.4 TDI	1422	77	08.2014		CUTA	2	GPE 74
FABIA III Estate (NJ5)	NEW 1.4 TDI	1422	55	05.2015	05.2016	CUSA	2	GPE 74
	NEW 1.4 TDI	1422	66	10.2014		CUSB	2	GPE 74
	NEW 1.4 TDI	1422	77	10.2014		CUTA	2	GPE 74
FELICIA I (6U1)	1.9 D	1896	47	10.1995	03.1998	AEF	4	G 17
FELICIA I Fun (797)	1.9 D	1896	47	06.1997	04.2002	AEF	4	G 17
FELICIA I Kombi (6U5)	1.9 D	1896	47	10.1995	03.1998	AEF	4	G 17
FELICIA II (6U1)	1.9 D	1896	47	01.1998	06.2001	AEF	4	G 17
FELICIA II Kombi (6U5)	1.9 D	1896	47	01.1998	06.2001	AEF	4	G 17
KAROQ (NU7)	NEW 1.6 TDI	1598	85	07.2017		DDYA	3	GPE 74





kW



Cyl.



SKODA									
	NEW	2.0 TDI 4x4	1968	110	07.2017		DFFA	3	GPE 74
	NEW	2.0 TDI 4x4	1968	140	07.2017		DFHA	3	GPE 74
KODIAQ (NS7)	NEW	2.0 TDI	1968	110	03.2017		DFGA/DBG/DBGC	3	GPE 74
	NEW	2.0 TDI 4x4	1968	110	03.2017		DFGA/DBG/DBGC	3	GPE 74
	NEW	2.0 TDI 4x4	1968	140	03.2017		DFHA	3	GPE 74
OCTAVIA (1U2)		1.9 SDI	1896	50	06.1997	12.2003	AQM/AGP	4	G 37
		1.9 TDI	1896	66	09.1996	03.2010	AGR/ALH	4	G 37
		1.9 TDI	1896	74	10.2005	12.2010	AXR	4	G 4
		1.9 TDI	1896	81	08.1997	01.2006	AHF/ASV	4	G 37
		1.9 TDI	1896	96	09.2002	09.2004	ASZ	4	G 4
OCTAVIA (1Z3)		1.6 TDI	1598	77	06.2009	04.2013	CAYC	4	GPE 74
		1.9 TDI	1896	77	06.2004	12.2010	BXE/BKC/BJB/BLS	4	GPE 70
		2.0 TDI	1968	81	03.2010	06.2013	CFHF/CLCA	4	GPE 74
		2.0 TDI	1968	100	02.2004	05.2010	AZV	4	GPE 71
		2.0 TDI	1968	103	11.2005	05.2010	BMM	4	GPE 70
		2.0 TDI 16V	1968	103	02.2004	04.2013	BKD	4	GPE 71
		2.0 TDI 16V	1968	103	02.2004	04.2013	CFHC/CLCB	4	GPE 74
		2.0 TDI RS	1968	125	04.2006	02.2013	CEGA	4	GPE 74
OCTAVIA (5E3)		1.6 TDI	1598	66	11.2012		CLHB	4	GPE 74
		1.6 TDI	1598	77	11.2012		CLHA	4	GPE 74
		1.6 TDI 4x4	1598	77	09.2014		CLHA	4	GPE 74
		1.6 TDI	1598	81	05.2013		CRKB	3	GPE 74
		1.6 TDI	1598	81	05.2013		CXXB/DBKA (Euro 5)	4	GPE 74
		1.6 TDI	1598	81	05.2013		CXXB/DBKA (Euro 6)	3	GPE 74
		1.6 TDI 4x4	1598	81	05.2015		CXXB (Euro 5)	4	GPE 74
		1.6 TDI 4x4	1598	81	05.2015		CXXB (Euro 6)	3	GPE 74
	NEW	1.6 TDI	1598	85	02.2017		DDYA	3	GPE 74
		2.0 TDI	1968	105	11.2012		CKFB/CRVC (Euro 5)	4	GPE 74
		2.0 TDI	1968	105	11.2012		CKFB/CRVC (Euro 6)	3	GPE 74
		2.0 TDI	1968	110	11.2012		CKFC/CRMB (Euro 5)	4	GPE 74
		2.0 TDI	1968	110	11.2012		CKFC/CRMB (Euro 6)	3	GPE 74
		2.0 TDI 4x4	1968	110	09.2014		CKFC (Euro 5)	4	GPE 74
		2.0 TDI 4x4	1968	110	09.2014		CKFC (Euro 6)	3	GPE 74
		2.0 TDI RS	1968	135	05.2013		CUPA/CUNA (Euro 5)	4	GPE 74
		2.0 TDI RS	1968	135	05.2013		CUPA/CUNA (Euro 6)	3	GPE 74
		2.0 TDI RS 4x4	1968	135	05.2013		CUPA/CUNA (Euro 5)	4	GPE 74
		2.0 TDI RS 4x4	1968	135	05.2013		CUPA/CUNA (Euro 6)	3	GPE 74
OCTAVIA Combi (1U5)		1.9 SDI	1896	50	07.1998	12.2003	AQM/AGP	4	G 37
		1.9 TDI	1896	66	07.1998	03.2010	AGR/ALH	4	G 37
		1.9 TDI 4x4	1896	66	11.1999	02.2006	AGR	4	G 37
		1.9 TDI	1896	74	08.2000	11.2001	AXR/ATD	4	G 37
		1.9 TDI	1896	74	12.2001	12.2010	AXR/ATD	4	G 4
		1.9 TDI 4x4	1896	74	09.2000	11.2001	ATD	4	G 37
		1.9 TDI 4x4	1896	74	12.2001	01.2006	ATD	4	G 4
		1.9 TDI	1896	81	07.1998	01.2006	AHF/ASV	4	G 37
		1.9 TDI	1896	96	09.2002	09.2004	ASZ	4	G 4
OCTAVIA Combi (1Z5)		1.6 TDI, 4x4	1598	77	06.2009	04.2013	CAYC	4	GPE 74
		1.9 TDI	1896	77	09.2004	12.2010	BXE/BKC/BJB/BLS	4	GPE 70
		1.9 TDI 4x4	1896	77	11.2004	12.2010	BXE/BKC/BLS	4	GPE 70
		2.0 TDI	1968	81	03.2013	06.2013	CFHF/CLCA	4	GPE 74
		2.0 TDI 4x4	1968	81	05.2011	02.2013	CFHF	4	GPE 74
		2.0 TDI 16V	1968	100	02.2004	05.2010	AZV	4	GPE 71
		2.0 TDI	1968	103	01.2006	05.2010	BMM	4	GPE 70
		2.0 TDI 4x4	1968	103	07.2006	05.2010	BMM	4	GPE 70
		2.0 TDI 16V	1968	103	02.2004	05.2013	BKD	4	GPE 71
		2.0 TDI 16V	1968	103	02.2004	05.2013	CFHC/CLCB	4	GPE 74
		2.0 TDI 16V 4x4	1968	103	05.2010	02.2013	CFHC	4	GPE 74
		2.0 TDI RS	1968	125	04.2006	02.2013	CEGA	4	GPE 74
OCTAVIA Combi (5E5)		1.6 TDI	1598	66	11.2012		CLHB (Euro 5)	4	GPE 74
		1.6 TDI	1598	66	11.2012		CLHB (Euro 6)	3	GPE 74
		1.6 TDI, 4x4	1598	77	11.2012		CLHA (Euro 5)	4	GPE 74
		1.6 TDI, 4x4	1598	77	11.2012		CLHA (Euro 6)	3	GPE 74
		1.6 TDI	1598	81	05.2013		CRKB	3	GPE 74
		1.6 TDI	1598	81	05.2013		CXXB/DBKA (Euro 5)	4	GPE 74
		1.6 TDI	1598	81	05.2013		CXXB/DBKA (Euro 6)	3	GPE 74

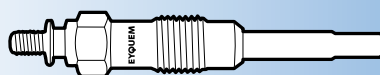



kW



Cyl.



SKODA

		1.6 TDI 4x4	1598	81	05.2015		CXXB (Euro 5)	4	GPE 74
		1.6 TDI 4x4	1598	81	05.2015		CXXB (Euro 6)	3	GPE 74
	NEW	1.6 TDI	1598	85	02.2017		DDVA	3	GPE 74
		2.0 TDI	1968	105	11.2012		CRVC/CKFB (Euro 5)	4	GPE 74
		2.0 TDI	1968	105	11.2012		CRVC/CKFB (Euro 6)	3	GPE 74
		2.0 TDI, 4x4	1968	110	11.2012		CKFC/CRMB (Euro 5)	4	GPE 74
		2.0 TDI, 4x4	1968	110	11.2012		CKFC/CRMB (Euro 6)	3	GPE 74
		2.0 TDI RS, 4x4	1968	135	05.2013		CUPA/CJUNA (Euro 5)	4	GPE 74
		2.0 TDI RS, 4x4	1968	135	05.2013		CUPA/CJUNA (Euro 6)	3	GPE 74
RAPID (NH3)	NEW	1.4 TDI	1422	66	05.2015		CUSB	2	GPE 74
	NEW	1.6 TDI	1598	66	08.2013		CAYB	4	GPE 74
	NEW	1.6 TDI	1598	77	07.2012		CAYC/CLNA	4	GPE 74
	NEW	1.6 TDI	1598	85	05.2015		CXMA	4	GPE 74
RAPID Spaceback (NH1)	NEW	1.4 TDI	1422	66	05.2015		CUSB	2	GPE 74
	NEW	1.6 TDI	1598	66	08.2013		CAYB	4	GPE 74
	NEW	1.6 TDI	1598	77	07.2012		CAYC/CLNA	4	GPE 74
	NEW	1.6 TDI	1598	85	05.2015		CXMA	4	GPE 74
ROOMSTER (5J)		1.2 TDI	1199	55	03.2010	05.2015	CFWA	3	GPE 74
		1.4 TDI	1422	51	07.2006	03.2010	BNM	3	G 4
		1.4 TDI	1422	59	09.2006	03.2010	BMS/BNV	3	G 4
		1.6 TDI	1598	66	03.2010	05.2015	CAYB	4	GPE 74
		1.6 TDI	1598	77	03.2010	05.2015	CAYC	4	GPE 74
		1.9 TDI	1896	74	03.2006	05.2006	AXR	4	G 4
		1.9 TDI	1896	77	09.2006	03.2010	BSW	4	G 4
ROOMSTER Praktik (5J)		1.2 TDI	1199	55	03.2010	05.2015	CFWA	3	GPE 74
		1.4 TDI	1422	51	03.2007	03.2010	BNM	3	G 4
		1.4 TDI	1422	59	03.2007	03.2010	BNV	3	G 4
		1.6 TDI	1598	66	03.2010	05.2015	CAYB	4	GPE 74
SUPERB (3T4)		1.6 TDI	1598	77	09.2010	05.2015	CAYC	4	GPE 74
		1.9 TDI	1896	77	03.2008	11.2010	BXE/BLS	4	GPE 70
		2.0 TDI 16V	1968	103	01.2009	05.2015	BKD	4	GPE 71
		2.0 TDI 16V	1968	103	01.2009	05.2015	CFFB/CLJA	4	GPE 74
		2.0 TDI 16V 4x4	1968	103	11.2010	05.2015	CFFB	4	GPE 74
		2.0 TDI, 4x4	1968	125	07.2008	05.2015	CFGB/CBBB	4	GPE 74
SUPERB (3U4)		1.9 TDI	1896	74	08.2002	10.2005	AVB	4	G 4
		1.9 TDI	1896	96	02.2002	03.2008	AWX/AVF	4	G 4
		2.5 TDI	2496	114	02.2002	08.2003	AYM	6	G 20
		2.5 TDI	2496	120	06.2003	03.2008	BDG	6	G 20
SUPERB Kombi (3T5)		1.6 TDI	1598	77	09.2010	05.2015	CAYC	4	GPE 74
		1.9 TDI	1896	77	10.2009	11.2010	BLS/BXE	4	GPE 70
		2.0 TDI 16V	1968	103	10.2009	05.2015	BKD	4	GPE 71
		2.0 TDI 16V	1968	103	10.2009	05.2015	CFFB/CLJA	4	GPE 74
		2.0 TDI 16V 4x4	1968	103	11.2010	05.2015	CFFB	4	GPE 74
		2.0 TDI, 4x4	1968	125	10.2009	05.2015	CFGB/CBBB	4	GPE 74
SUPERB III (3V3)	NEW	1.6 TDI	1598	88	03.2015		DCZA/DCXA	3	GPE 74
	NEW	2.0 TDI, 4x4	1968	110	03.2015		CRLB/DFEA	3	GPE 74
	NEW	2.0 TDI, 4x4	1968	140	03.2015		DDAA/DFCA	3	GPE 74
SUPERB III Combi (3V5)	NEW	1.6 TDI	1598	88	03.2015		DCZA/DCXA	3	GPE 74
	NEW	2.0 TDI, 4x4	1968	110	03.2015		CRLB/DFEA	3	GPE 74
	NEW	2.0 TDI, 4x4	1968	140	03.2015		DDAA/DFCA	3	GPE 74
YETI (5L)		1.6 TDI	1598	77	11.2010		CAYC	4	GPE 74
		2.0 TDI	1968	81	11.2009		CLCA/CFHA	4	GPE 74
		2.0 TDI 4x4	1968	81	11.2009		CFHF	4	GPE 74
		2.0 TDI	1968	103	11.2011		CFHC	4	GPE 74
		2.0 TDI 4x4	1968	103	05.2009		CBDB/CFHC/CLCB	4	GPE 74
	NEW	2.0 TDI, 4x4	1968	110	05.2015		CUUB	3	GPE 74
		2.0 TDI 4x4	1968	125	11.2009		CEGA/CFJA	4	GPE 74

SMART

CABRIO		0.8 CDI (S10LC1)	799	30	03.2001	01.2004	OM 660 DE 8LA	3	G 22
CITY-COUPE (MC01)		0.8 CDI (S1CLC1)	799	30	11.1999	01.2004	OM 660 DE 8LA	3	G 22
FORTWO Cabrio		0.8 CDI (450.400)	799	30	01.2004		OM 660 DE 8LA	3	G 22
FORTWO Coupe		0.8 CDI (450.300)	799	30	01.2004		OM 660 DE 8LA	3	G 22

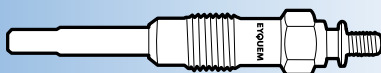



kW



Cyl.

**SSANGYONG**

ACTYON I	NEW 2.0 Xdi	1998	100	07.2007		D20DT	4	G 87
	NEW 2.0 Xdi	1998	104	11.2005		D20DT	4	G 87
	NEW 200 Xdi 4WD	1998	100	07.2007		D20DT	4	G 87
ACTYON SPORTS I (QJ)	NEW 2.0 Xdi 4WD	1998	104	04.2007		D20DT	4	G 87
KORANDO (K4)	2.2 D	2238	50	12.1988	12.1996	DC23	4	G 47
KORANDO (KJ)	2.3 D (KJ)	2299	58	12.1996		OM 601.940	4	G 24
	2.9 D (KJ)	2874	72	12.1996		MB-OM 662	5	G 24
	2.9 TD	2874	88	04.1998			5	G 24
KORANDO Cabrio (KJ)	2.9 D	2874	72	11.1997		MB-OM 662	5	G 24
	2.9 TD	2874	88	04.1998			5	G 24
KYRON	NEW 2.0 Xdi	1998	100	01.2010		D20DT	4	G 87
	NEW 2.0 Xdi	1998	104	05.2005		D20DT	4	G 87
	NEW 2.0 Xdi 4x4	1998	104	05.2005		D20DT	4	G 87
	NEW 2.0 Xdi 4x4	1998	100	01.2010		D20DT	4	G 87
	NEW 2.7 Xdi	2696	120	03.2006		D27DT	5	G 87
	NEW 2.7 Xdi	2696	121	05.2005		D27DT	5	G 87
MUSSO (FJ)	2.3 D	2299	59	10.1995		OM 601.940/MB-OM 661	4	G 24
	2.9 D	2874	73	03.1996		MB-OM 662	5	G 24
	2.9 TD	2874	88	04.1998			5	G 24
REXTON (GAB_)	2.9 TD	2874	88	04.2002			5	G 24
	NEW 2.7 Xdi	2696	120	08.2004		D27DT	5	G 87
	NEW 2.7 Xdi 4x4	2696	118	03.2011		D27DT	5	G 87
	NEW 2.7 Xdi Turbo 4x4	2696	132	03.2011		D27DTP	5	G 87
	NEW 2.7 D 4x4	2696	137	05.2006		D27DTP	5	G 87
RODIUS	NEW 2.7 Xdi	2696	121	05.2005		D27DT	5	G 87
	NEW 2.7 Xdi	2696	120	05.2005		D27DT	5	G 87
	NEW 2.7 Xdi 4WD	2696	120	05.2005		D27DT	5	G 87
	NEW 2.7 Xdi 4WD	2696	121	05.2005		D27DT	5	G 87

SUZUKI

BALENO (EG)	1.9 TD	1905	55	04.1998	05.2002		4	G 41
BALENO Kombi (EG)	1.9 TD	1905	55	04.1998	05.2002		4	G 41
BALENO Hatchback (EG)	1.9 TD	1905	55	04.1998	05.2002		4	G 41
GRAND VITARA (FT, GT)	2.0 HDI 110	1997	80	07.2001		RHZ	4	G 57
	2.0 HDI 110 16V	1997	80	07.2001		RHW	4	G 57
	2.0 TD Intercooler	1998	64	03.1998		RF	4	G 1
GRAND VITARA (JT)	1.9 DDIS	1870	95	10.2005			4	G 28
	NEW 1.9 DDIS	1870	95	10.2005		F9QB	4	GPE 79
IGNIS II	1.3 DDIS	1248	51	09.2003		Z13DT	4	G 7
JIMNY (FJ)	1.5 DDIS 4WD	1461	48	12.2003		K9K 700	4	G 28
	1.5 DDIS 4x4	1461	63	08.2005		K9K 266	4	G 28
LIANA (ER)	1.4 DDIS	1398	66	04.2004		8HY	4	G 6
LIANA Kombi (ER)	1.4 DDIS	1398	66	04.2004		8HY	4	G 6
SAMURAI (SJ)	1.9 TD	1905	46	11.1998		XUD9	4	G 41
SWIFT III (SG)	1.3 DDIS	1248	51	08.2005		Z13DT	4	G 7
SX4 (GY)	NEW 1.9 DDIS	1910	88	06.2006		D19AA	4	G 89
SX4 (GY) 4x4	NEW 1.9 DDIS	1910	88	06.2006		D19AA	4	G 89
SX4 (GY)	NEW 2.0 DDIS	1956	99	07.2009		D20AA	4	GPE 82
	NEW 2.0 DDIS 4x4	1956	99	07.2009		D20AA	4	GPE 82
SX4 S-Cross (GY)	NEW 1.6 DDIS	1598	88	08.2013		D16AA	4	GPE 82
VITARA (ET, TA)	1.9 D (ET)	1905	50	01.1995	03.1998	XUD9A	4	G 41
	1.9 D (ET)	1905	55	08.1996	03.1998	XUD9SD	4	G 41
	2.0 TD (ET)	1998	52	12.1994	03.1998	RF	4	G 1
	2.0 TD Intercooler (ET)	1998	64	12.1995	03.1998	RF	4	G 1
VITARA Cabrio (ET, TA)	1.9 D (ET)	1905	50	01.1995	03.1998	XUD9A	4	G 41
	1.9 D (ET)	1905	55	08.1996	03.1999	XUD9SD	4	G 41
WAGON R+ (MM)	1.3 DDIS	1248	51	09.2003		Z13DT	4	G 7

TALBOT

180	1.9 D	1918	44	01.1982	12.1982		4	G 41
	1.9 D	1918	44	01.1982	12.1982		4	G 41
	1.9 D	1918	44	01.1982	12.1982		4	G 41
EXPRESS 1000 -1500 Bus	1.9 D	1905	51	07.1987	10.1990	XUD9A	4	G 41
EXPRESS 1000 -1800 Camionnette	1.9 D	1905	51	07.1987	10.1990	XUD9A	4	G 41
HORIZON	1.9 Diesel	1905	47	07.1984	06.1986	XUD9	4	G 41





kW



Cyl.



TALBOT

	1.9 Diesel	1905	48	07.1982	06.1986	XUD9	4	G 41
	1.9 Diesel	1905	47	07.1984	06.1986	XUD9	4	G 41
	1.9 Diesel	1905	48	07.1982	06.1986	XUD9	4	G 41
	1.9 Diesel	1905	47	07.1984	06.1986	XUD9	4	G 41
	1.9 Diesel	1905	48	07.1982	06.1986	XUD9	4	G 41
SIMCA 1609/1610	1610 2.0 D	1918	44	09.1976	12.1980		4	G 41
	1610 2.0 D	1918	44	09.1976	12.1980		4	G 41
	1610 2.0 D	1918	44	09.1976	12.1980		4	G 41
TAGORA	2.3 Turbo Diesel	2288	59	08.1981	12.1987	XD2S	4	G 41
	2.3 Turbo Diesel	2288	59	08.1981	12.1987	XD2S	4	G 41
	2.3 Turbo Diesel	2288	59	08.1981	12.1987	XD2S	4	G 41

TOYOTA

AURIS (_E15_)	1.4 D-4D (NDE150_)	1364	66	03.2007	09.2012	1ND-TV	4	G 26
	NEW 2.0 D-4D (ADE150_)	1998	93	03.2007	09.2012	1AD-FTV	4	G 86
	NEW 2.2 D (ADE157_)	2231	130	03.2007	09.2012	2AD-FHV	4	G 86
AURIS (_E18_)	1.4 D-4D (NDE180_)	1364	66	10.2012		1ND-TV	4	G 26
	NEW 2.0 D-4D (ADE186_)	1998	91	10.2012		1AD-FTV	4	G 86
AURIS TOURING SPORTS(_E18_)	NEW 1.4 D-4D (NDE180_)	1364	66	07.2013		1ND-TV	4	G 26
	NEW 2.0 D-4D (ADE186_)	1998	91	07.2013		1AD-FTV	4	G 86
AVENSIS (_T22_)	NEW 2.0 D (CT220_)	1974	61	10.1997	05.1998	2C-TE	4	G 84
	NEW 2.0 TD (CT220)	1975	66	09.1997	07.2000	2C-TE	4	G 84
	2.0 D-4D (CDT220_)	1995	81	10.1999	02.2003	1CD-FTV	4	G 75
AVENSIS (T25)	2.0 D-4D	1995	85	04.2003		1CD-FTV	4	G 75
	NEW 2.0 D-4D	1998	93	03.2006	11.2008	1AD-FTV	4	G 86
	NEW 2.2 D-4D	2231	110	10.2005	11.2008	2AD-FHV	4	G 86
	NEW 2.2 D-CAT	2231	130	07.2005	11.2008	2AD-FHV	4	G 86
AVENSIS Kombi (ZRT27_ADT27_)	NEW 2.2 D-4D	2231	110	02.2009		2AD-FHV/2AD-FTV	4	G 86
	NEW 2.2 D-4D	2231	130	02.2009		2AD-FHV	4	G 86
AVENSIS Liftback (_T22_)	NEW 2.0 TD (CT220)	1975	66	09.1997	07.2000	2C-TE	4	G 84
	2.0 D-4D (CDT220_)	1995	81	10.1999	02.2003	1CD-FTV	4	G 75
	2.0 D (CDT220_)	1995	85	09.2002	02.2003	1CD-FTV	4	G 75
AVENSIS Station Wagon (_T22_)	NEW 2.0 D (CDT220_)	1974	61	10.1997	05.1998	2C-TE	4	G 84
	NEW 2.0 TD (CT220)	1975	66	09.1997	07.2000	2C-TE	4	G 84
	2.0 D-4D (CDT220_)	1995	81	10.1999	02.2003	1CD-FTV	4	G 75
	2.0 D (CDT220_)	1995	85	09.2002	02.2003	1CD-FTV	4	G 75
AVENSIS A (T25)	2.0 D-4D	1995	85	04.2003	11.2008	1CD-FTV	4	G 75
	NEW 2.0 D-4D	1998	93	03.2006	11.2008	1AD-FTV	4	G 86
	NEW 2.2 D-4D	2231	110	10.2005	11.2008	2AD-FHV	4	G 86
	NEW 2.2 D-CAT	2231	130	07.2005	11.2008	2AD-FHV	4	G 86
AVENSIS Station Wagon (T25)	2.0 D-4D	1995	85	04.2003	11.2008	1CD-FTV	4	G 75
	NEW 2.0 D-4D	1998	93	03.2006	11.2008	1AD-FTV	4	G 86
	2.2 D-4D	2231	110	10.2005	11.2008	2AD-FTV	4	G 86
	NEW 2.2 D-CAT	2231	130	07.2005	11.2008	2AD-FHV	4	G 86
AVENSIS A (_T27_)	NEW 2.0 D-4D (ADT270_)	1998	91	11.2011		1AD-FTV	4	G 86
	NEW 2.0 D-4D (ADT270_)	1998	93	11.2008		1AD-FTV	4	G 86
	NEW 2.2 D-4D (ADT271_)	2231	110	02.2009		2AD-FHV	4	G 86
	NEW 2.2 D-4D (ADT271_)	2231	130	02.2009		2AD-FHV	4	G 86
AVENSIS Station Wagon (_T27_)	NEW 2.0 D-4D (ADT270_)	1998	91	11.2011		1AD-FTV	4	G 86
	NEW 2.0 D-4D (ADT270_)	1998	93	02.2009		1AD-FTV	4	G 86
	NEW 2.2 D-4D (ADT271_)	2231	110	02.2009		2AD-FHV	4	G 86
	NEW 2.2 D-4D (ADT271_)	2231	130	02.2009		2AD-FHV	4	G 86
AVENSIS VERSO (_M2_)	2.0 D-4D	1995	85	08.2001	08.2005	1CD-FTV	4	G 75
AYGO (_B1_)	1.4 HDi (WNB10)	1398	40	07.2005	08.2010	2WZ-TV	4	G 6
CAMRY (_V2_)	2.0 Turbo-D (CV20_)	1975	62	11.1986	07.1988	2C-T	4	G 14
	NEW 2.0 Turbo-D (CV20_)	1975	62	08.1988	05.1991	2C-T	4	G 84
	NEW 2.0 Turbo-D (CV20_)	1975	63	11.1988	05.1991	2C-T	4	G 84
CAMRY A (V1)	1.8 Turbo-D	1840	54	11.1983	01.1988	1C-TL	4	G 14
CAMRY Liftback (V1)	1.8 Turbo-D	1840	54	10.1984	01.1988	1C-TL	4	G 14
CAMRY Station Wagon (_V2_)	2.0 Turbo-D (CV20_)	1975	62	11.1986	07.1988	2C-T	4	G 14
	NEW 2.0 Turbo-D (CV20_)	1975	62	08.1988	05.1991	2C-T	4	G 84
	NEW 2.0 Turbo-D (CV20_)	1975	63	11.1988	05.1991	2C-T	4	G 84
CAMRY Tricorps (V1)	1.8 Turbo-D	1840	54	11.1983	01.1988	1C-TL	4	G 14
CARINA (TA4L, TA6_L)	1.8 D	1840	48	04.1982	09.1983	1C	4	G 14
CARINA Station Wagon (A6_)	1.8 D	1840	48	04.1982	09.1983	1C	4	G 14

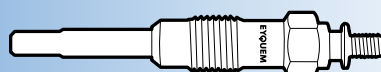



kW



Cyl.



TOYOTA

CARINA II (_T15_) 2.0 D	1974	50	02.1984	11.1987	2C-L	4	G 14
2.0 D (CT150)	1974	51	12.1985	11.1987	2C-L	4	G 14
CARINA II A (_T15_) 2.0 D (CT150)	1974	50	02.1984	11.1987	2C-L	4	G 14
CARINA II Tricorps (_T15_) 2.0 D	1974	50	02.1984	05.1988	2C-L	4	G 14
CARINA II (T17) 2.0 D	1974	54	03.1988	06.1992	2C-L	4	G 84
CARINA II A (T17) 2.0 D	1974	54	03.1988	06.1992	2C	4	G 84
CARINA Station Wagon (TA4K, TA6K) 1.8 D	1840	48	04.1982	09.1983	1C	4	G 14
CARINA II Station Wagon (T17) 2.0 D (CT170_)	1975	54	12.1987	01.1992	2C-L	4	G 84
2.0 D (CT190)	1975	54	01.1993	01.1996	2C	4	G 84
CARINA Sports Wagon (T19) 2.0 D (CT170)	1975	54	12.1987	01.1992	2C-L	4	G 84
2.0 TD (CT190)	1975	61	01.1996	09.1997	2C-T	4	G 84
CARINA E (T19) 2.0 D (CT190)	1975	54	04.1992	01.1996	2C	4	G 84
2.0 TD (CT190)	1975	61	01.1996	09.1997	2C-T	4	G 84
CARINA E A (T19) 2.0 D (CT190)	1975	54	08.1992	01.1996	2C	4	G 84
2.0 TD (CT190)	1975	61	01.1996	09.1997	2C-T	4	G 84
CARINA E Sportswagon (T19) 2.0 D (CT190)	1975	54	01.1993	01.1996	2C	4	G 84
2.0 TD (CT190)	1975	61	01.1996	09.1997	2C-T	4	G 84
COROLLA (E10) 2.0 D (CE100)	1975	53	07.1992	04.1997	2C	4	G 84
2.0 D (CE100)	1975	53	04.1997	02.2000	2C-E	4	G 84
COROLLA (_E11_) 2.0 D-4D	1995	66	09.2000	01.2002	1CD-FTV	4	G 75
COROLLA (_E12U_, _E12J_) 1.4 D	1364	66	07.2004		1ND-TV	4	G 26
2.0 D-4D	1995	66	01.2002		1CD-FTV	4	G 75
2.0 D-4D	1995	81	01.2002		1CD-FTV	4	G 75
2.0 D-4D	1995	85	05.2003		1CD-FTV	4	G 75
COROLLA (_E7_) 1.8 D (CE70)	1839	43	01.1983	09.1983	1C	4	G 14
COROLLA (_E8_) 1.8 D	1839	47	07.1985	04.1987	1C-L	4	G 14
1.8 D	1840	43	06.1983	04.1987	1C	4	G 14
COROLLA (_E9_) 1.8 D	1840	47	07.1987	04.1992	1C	4	G 84
1.8 D (CE90)	1839	47	08.1987	04.1992	1C	4	G 84
1.8 D (CE90)	1839	49	08.1989	04.1992	1C	4	G 84
1.8 D	1840	57	07.1987	06.1993	1C	4	G 84
1.8 D	1840	49	11.1989	06.1993	1C	4	G 84
COROLLA (_E10_) 2.0 D (CE100)	1975	53	07.1992	04.1997	2C	4	G 84
COROLLA (_E11_) 1.9 D (WZE110)	1867	51	02.2000	11.2001	1WZ	4	G 34
2.0 D	1975	53	01.1997	10.1999	2C-E	4	G 84
2.0 D-4D (CDE110)	1995	66	09.2000	11.2001	1CD-FTV	4	G 75
COROLLA (_E12_) 1.4 (NDE120)	1364	66	07.2004	02.2007	1ND-TV	4	G 26
2.0 D-4D (CDE120)	1995	66	01.2002	12.2006	1CD-FTV	4	G 75
2.0 D-4D (CDE120R, CDE120L)	1995	81	01.2002	12.2006	1CD-FTV	4	G 75
2.0 D-4D (CDE120R, CDE120L)	1995	85	05.2003	02.2007	1CD-FTV	4	G 75
COROLLA A (_E12_) 1.4 (NDE120)	1364	66	07.2004	07.2007	1ND-TV	4	G 26
2.0 D-4D (CDE120)	1995	66	08.2002	07.2007	1CD-FTV	4	G 75
2.0 D-4D (CDE120)	1995	85	06.2004	07.2007	1CD-FTV	4	G 75
COROLLA A (_E15_) 1.4 D-4D	1364	66	10.2006		1ND-TV	4	G 26
2.0 D4-D	1998	93	01.2007		1AD-FTV	4	G 86
COROLLA A (_E18_, ZRE17_) 1.4 D-4D	1364	66	06.2013		1ND-TV	4	G 26
COROLLA Compact (_E9_) 1.8 D (CE90)	1840	47	08.1987	04.1992	1C	4	G 84
1.8 D (CE90)	1840	49	08.1989	04.1992	1C	4	G 84
COROLLA Compact (_E10_) 2.0 D (CE100)	1975	53	07.1992	04.1997	2C	4	G 84
COROLLA Compact (_E11_) 1.9 D (WZE110)	1867	51	02.2000	01.2002	1WZ	4	G 34
2.0 D (CE110)	1975	53	04.1997	09.1999	2C-E	4	G 84
2.0 D-4D	1995	66	09.2000	01.2002	1CD-FTV	4	G 75
COROLLA (E15) 2.2 D-4D	2231	130	11.2006		2AD-FHV	4	G 86
COROLLA FX Compact (E8B) 1.8 D	1839	43	01.1985	04.1987	1C	4	G 14
1.8 D	1839	47	08.1985	04.1987	1C-L	4	G 14
COROLLA Kombi (_E12J_, _E12T_) 1.4 D	1364	66	07.2004		1ND-TV	4	G 26
2.0 D-4D	1995	66	01.2002		1CD-FTV	4	G 75
2.0 D-4D	1995	85	04.2004		1CD-FTV	4	G 75
COROLLA Hatchback (_E7_) 1.8 D	1839	48	01.1983	09.1983	1C	4	G 14
COROLLA Liftback (_E8_) 1.8 D (CE80)	1839	43	06.1983	04.1987	1C	4	G 14
1.8 D (CE80)	1839	47	06.1983	04.1987	1C-L	4	G 14
COROLLA Liftback (_E10_) 2.0 D (CE100)	1975	53	07.1992	04.1997	2C	4	G 84
COROLLA Liftback (_E11_) 1.8 D (CE70)	1839	48	01.1983	09.1983	1C	4	G 14
1.9 D (WZE110)	1867	51	02.2000	01.2002	1WZ	4	G 34
2.0 D (CE110)	1975	53	04.1997	09.1999	2C-E	4	G 84

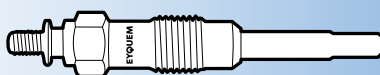



kW



Cyl.



TOYOTA

	2.0 D-4D	1995	66	09.2000	01.2002	1CD-FTV	4	G 75
COROLLA Saloon (_E7_)	1.8 D (CE70)	1839	43	01.1983	09.1983	1C	4	G 14
COROLLA Station Wagon (_E7_)	1.8 D (CE70)	1839	44	05.1983	08.1987	1C	4	G 14
COROLLA Station Wagon (_E9_)	1.8 D	1839	44	05.1983	08.1987	1C	4	G 14
	NEW 1.8 D (CE90)	1839	47	12.1987	06.1992	1C	4	G 84
	NEW 1.8 D (CE90)	1840	49	08.1989	06.1992	1C	4	G 84
COROLLA Station Wagon (_E11_)	1.9 D (WZE110)	1867	51	02.2000	10.2001	1WZ	4	G 34
	NEW 2.0 D (CE 110)	1975	53	04.1997	10.1999	2C-E	4	G 84
	2.0 D-4D	1995	66	09.2000	10.2001	1CD-FTV	4	G 75
COROLLA Station Wagon (_E12_)	1.4 D (NDE120)	1364	66	07.2004	02.2007	1ND-TV	4	G 26
	2.0 D-4D (CDE120)	1995	66	01.2002	02.2007	1CD-FTV	4	G 75
	2.0 D-4D (CDE120)	1995	85	04.2004	02.2007	1CD-FTV	4	G 75
COROLLA Tricorps (_E12J_, _E12T_)	1.4 D	1364	66	07.2004		1ND-TV	4	G 26
	2.0 D-4D	1995	66	08.2002		1CD-FTV	4	G 75
COROLLA Verso (_E12J_)	2.0 D-4D	1995	66	01.2002	05.2004	1CD-FTV	4	G 75
COROLLA Verso (ZER_, ZZE_, R1_)	2.0 D-4D	1995	85	04.2004	03.2009	1CD-FTV	4	G 75
	NEW 2.2 D-4D	2231	100	10.2005	09.2008	2AD FTV	4	G 86
	NEW 2.2 D-4D	2231	110	10.2005	03.2009	2AD FTV	4	G 86
	NEW 2.2 D-4D	2231	130	10.2005	03.2009	2AD-FHV	4	G 86
COROLLA Wagon (_E10_)	NEW 2.0 D (CE100)	1975	53	07.1992	04.1997	2C	4	G 84
COROLLA Wagon (_E11_)	NEW 2.0 D (CE 110)	1975	53	04.1997	10.1999	2C-E	4	G 84
	2.0 D-4D	1995	66	09.2000	01.2002	1CD-FTV	4	G 75
CRESSIDA Station Wagon (X6K, MX62)	2.2 D	2173	49	06.1981	03.1985	L	4	G 16
CRESSIDA Tricorps (_X6_)	2.2 D (LX60)	2173	49	09.1980	07.1984	L	4	G 16
IQ (KGJ1_NGJ1)	1.4 D-4D	1364	66	01.2009		1ND-TV	4	G 26
HIACE II Camionnette (H20)	2.2 D	2173	49	03.1983	11.1989	L	4	G 16
	2.4 D	2446	55	05.1984	11.1989	2L	4	G 18
	2.2 D (H5G)	2173	49	03.1983	11.1989	L	4	G 16
	2.4 D (H5G)	2446	55	08.1984	08.1989	2L	4	G 16
	2.4 D 4WD (H5F)	2446	54	01.1987	01.1988	2L	4	G 16
HIACE III Camionnette (H50)	2.4 D 4WD	2446	55	08.1989	08.1995	2L	4	G 18
	2.4 Diesel	2446	55	02.1990	08.1995	2L	4	G 18
	2.4 D	2446	57	10.1993	08.1995	2L	4	G 18
	2.4 D (LH102)	2446	55	08.1989	08.1995	2L	4	G 18
	2.4 D 4WD	2446	55	08.1989	08.1995	2L	4	G 18
HIACE IV Camionnette	2.4 D (LXH12_, LXH22_)	2446	58	08.1995	08.1997	2L	4	G 18
	2.4 TD (LXH12_, LXH22_)	2446	66	08.1995		2L-T	4	G 18
	2.4 TD 4WD (LXH18_, LXH28_)	2446	66	08.1995		2L-T	4	G 18
HIACE IV Wagon	2.4 D	2446	58	08.1995		2L	4	G 18
	2.4 D	2446	55	07.1999		2L	4	G 18
	2.4 TD (LXH12_, LXH22_)	2446	66	08.1995		2L-T	4	G 18
	2.4 TD 4WD (H18/28)	2446	66	08.1995		2L-T	4	G 18
	2.5 D-4D	2494	65	11.2001	08.2006	2KD-FTV	4	G 75
	2.5 D-4D	2494	70	08.2001		2KD-FTV	4	G 75
	2.5 D-4D	2494	75	11.2001	08.2006	2KD-FTV	4	G 75
	2.5 D-4D	2494	86	08.2006		2KD-FTV	4	G 75
HIACE V Camionnette (TRH2, KDH2)	2.5 D-4D	2494	70	09.2006		2KD-FTV	4	G 75
	2.5 D-4D	2494	86	09.2006		2KD-FTV	4	G 75
HILUX II Pick-up (_N_)	2.4 D	2446	58	03.1995		2L	4	G 18
	2.4 D	2446	55	07.1998	01.2002	2L	4	G 18
	2.4 D	2446	59	01.1992		2L	4	G 18
	2.4 D	2446	61	08.1988		2L	4	G 18
	2.4 D 4WD	2446	58	01.1994		2L	4	G 18
	2.4 D 4WD	2446	61	08.1988		2L	4	G 18
	2.4 TD 4WD	2446	66	08.1998	01.2002	2L-T	4	G 18
HILUX III Pick-up (_TGN1_)	2.5 D-4D	2494	75	06.2006		2KD-FTV	4	G 75
	2.5 D-4D	2494	88	12.2007		2KD-FTV	4	G 75
	2.5 D-4D	2494	106	12.2007		2KD-FTV	4	G 75
HILUX V Pick-up (_N_, KZN1_, VZN1_)	2.4 D	2446	55	10.1988	08.1991	2L	4	G 18
	2.4 D	2446	58	03.1995	08.1997	2L	4	G 18
	2.4 D	2446	59	01.1992	08.1997	2L	4	G 18
	2.4 D	2446	61	09.1988	08.1997	2L	4	G 18
	2.4 D	2446	73	08.1991	07.1997		4	G 18
HILUX VI Pick-up (_N1_)	2.4 D	2446	55	08.1997	02.2006	2L	4	G 18

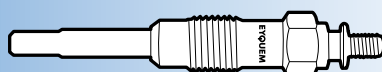



kW



Cyl.



TOYOTA									
	2.4 TD	2446	66	08.1998	01.2002		2L	4	G 18
	2.5 D4-D	2494	65	11.2001	07.2005		2KD-FTV	4	G 75
HILUX VII Pick-up (_N1_, _N2_, _N3_)	2.5 D4-D, 4WD	2494	75	10.2005			2KD-FTV	4	G 75
	2.5 D4-D, 4WD	2494	88	12.2007			2KD-FTV	4	G 75
	2.5 D4-D, 4WD	2494	106	09.2009			2KD-FTV	4	G 75
IQ (_J1_) NEW	1.4 D4-D	1364	66	01.2009			1ND-TV	4	G 26
LAND CRUISER (_J7_)	2.4 D (LJ70_)	2446	53	11.1984	10.1985		2L	4	G 16
	2.4 D (LJ70_)	2446	63	01.1990			2L-T	4	G 18
	2.4 TD (LJ70)	2446	66	01.1990	05.1993		2L-T	4	G 18
NEW	3.4 D (BJ70, BJ73)	3432	70	09.1988	12.1996		3B	4	G 84
	2.4 TD (LJ70_, LJ73_)	2446	63	10.1985	05.1990		2L-T	4	G 18
LAND CRUISER Hardtop (_J7_)	2.4 TD (LJ77)	2446	66	07.1990	05.1996		2L-T	4	G 18
LAND CRUISER 80 (J8) NEW	4.2 D (HZJ80)	4164	99	01.1990	12.1997		1H-Z	6	G 84
NEW	4.2 TD (HDJ80)	4164	118	10.1992	12.1997		1HD-T	6	G 84
NEW		4164	123	01.1990	12.1997		1HD-T	6	G 84
LAND CRUISER (PZJ7_KZJ7_HZJ7_BJ7_LJ7_RJ7) NEW	3.4 D	3432	70	11.1984	12.1996		3B	4	G 84
LAND CRUISER (VDJ20_UZJ20) NEW	4.5 D	4461	173	08.2008			1VD-FTV	8	G 86
NEW	4.5 D V8 (VDJ200)	4461	195	01.2008			1VD-FTV	8	G 86
LAND CRUISER 200 (_J2_) NEW	4.5 D4-D	4461	200	01.2012			1VD-FTV	8	G 86
NEW	4.5 D V8 (VDJ200)	4461	210	01.2008			1VD-FTV	8	G 86
LITEACE Camionette (CM3_V, KM3_V)	1.8 D (CM20)	1839	41	10.1982	09.1985			4	G 14
	1.8 D (CM35_V)	1839	46	10.1985	08.1988		1C	4	G 14
NEW	2.0 D	1975	53	08.1988	01.1992		2C	4	G 84
LITEACE Bus (_M3_) NEW	2.0 D	1975	53	08.1988	01.1992		2C	4	G 84
PREVIA (CLR3_, ACR3_)	2.0 D-4D	1995	85	03.2001	01.2006		1CD-FTV	4	G 75
RAV 4 II (_A2_)	2.0 D-4D 4WD	1995	85	05.2001	11.2005		1CD-FTV	4	G 75
RAV 4 III (_A3_) NEW	2.2 D-4D 4WD	2231	100	03.2006			2AD-FTV	4	G 86
NEW	2.2 D-4D	2231	110	12.2008	12.2013		2AD-FHV/2AD-FTV	4	G 86
NEW	2.2 D-4D 4WD	2231	130	03.2006			2AD-FHV	4	G 86
RAV 4 IV (_A4_) NEW	2.2 D 4WD	2231	110	12.2012			2AD-FHV/2AD-FTV	4	G 86
STARLET (_P7_)	1.5 D (NP70L)	1453	40	12.1986	12.1989		1N	4	G 16
STARLET (_P8_)	1.5 D (NP80_)	1453	40	12.1989	03.1996		1N	4	G 18
URBAN CRUISER (_P1_)	1.4 D-4D, 4WD	1364	66	01.2009	04.2014		1ND-TV	4	G 26
VERSO (_R2_) NEW	2.0 D-4D	1998	91	11.2012			1AD-FTV	4	G 86
NEW	2.0 D-4D	1998	93	04.2009			1AD-FTV	4	G 86
NEW	2.2 D-4D	2231	110	04.2009			2AD-FHV	4	G 86
NEW	2.2 D-CAT	2231	130	04.2009			2AD-FHV	4	G 86
VERSO S (_P12_)	1.4 D-4D	1364	66	11.2010	10.2016		1ND-TV	4	G 26
YARIS (_P1_)	1.4 D-4D	1364	55	10.2001	09.2005		1ND-TV	4	G 26
YARIS VERSO (_P2_)	1.4 D-4D	1364	55	12.2001	09.2005		1ND-TV	4	G 26
YARIS (_P9_)	1.4 D-4D	1364	66	08.2005			1ND-TV	4	G 26
YARIS VERSO (NC/LP2_)	1.4 D-4D (NLP22)	1364	55	12.2001			1ND-TV	4	G 26

VAUXHALL									
AGILA Mk II (B)	1.3 CDTI	1248	55	01.2008			Z 13 DTJ	4	G 7
ARENA Combi	1.9 D	1870	44	03.1998	08.2001		F8Q 606/F8Q 600	4	G 54
	2.5 D	2499	55	03.1998	08.2001		S8U 780/S8U 782/S8U 758	4	G 41
	2.5 D	2499	55	03.1998	08.2001		S8U 780/S8U 782/S8U 758	4	G 41
	2.5 D	2499	55	03.1998	08.2001		S8U 780/S8U 782/S8U 758	4	G 41
ARENA Van	1.9 D	1870	44	03.1998	08.2001		F8Q 606/F8Q 600	4	G 54
	2.5 D	2499	55	03.1998	08.2001		S8U 780/S8U 782/S8U 758	4	G 41
	2.5 D	2499	55	03.1998	08.2001		S8U 780/S8U 782/S8U 758	4	G 41
	2.5 D	2499	55	03.1998	08.2001		S8U 780/S8U 782/S8U 758	4	G 41
ASTRA CC	1.6 D	1598	40	03.1982	08.1986		16 D	4	G 41
	1.6 D	1598	40	03.1982	08.1986		16 D	4	G 41
	1.6 D	1598	40	03.1982	08.1986		16 D	4	G 41
ASTRA Estate	1.6 D	1598	40	02.1982	08.1986		16 D	4	G 41
	1.6 D	1598	40	02.1982	08.1986		16 D	4	G 41
	1.6 D	1598	40	02.1982	08.1986		16 D	4	G 41
ASTRA Mk II Belmont	1.5 DT	1499	49	01.1988	08.1990		15 DT (T4EC1)	4	G 48
	1.5 DT	1499	53	01.1987	08.1989		15 DT	4	G 48
	1.6 D	1598	40	09.1985	08.1991		16 DA	4	G 41
	1.6 D	1598	40	09.1985	08.1991		16 DA	4	G 41

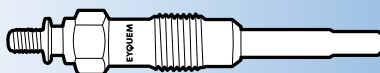



kW



Cyl.



VAUXHALL

	1.6 D	1598	40	09.1985	08.1991	16 DA	4	G 41
	1.7 D	1699	42	01.1989	12.1991	17 D	4	G 41
	1.7 D	1699	42	01.1989	12.1991	17 D	4	G 41
	1.7 D	1699	42	01.1989	12.1991	17 D	4	G 41
ASTRA Mk II CC	1.6 D	1598	40	09.1984	12.1989	16 DA	4	G 41
	1.6 D	1598	40	09.1984	12.1989	16 DA	4	G 41
	1.6 D	1598	40	09.1984	12.1989	16 DA	4	G 41
	1.7 D	1699	42	01.1989	08.1991	17 DR	4	G 41
	1.7 D	1699	42	01.1989	08.1991	17 DR	4	G 41
	1.7 D	1699	42	01.1989	08.1991	17 DR	4	G 41
ASTRA Mk II Estate	1.5 DT	1499	49	01.1988	08.1991	15 DT (T4EC1)	4	G 48
	1.6 D	1598	40	09.1984	12.1989	16 DA	4	G 41
	1.6 D	1598	40	09.1984	12.1989	16 DA	4	G 41
	1.6 D	1598	40	09.1984	12.1989	16 DA	4	G 41
	1.7 D	1699	42	02.1989	08.1991	17 D	4	G 41
	1.7 D	1699	42	02.1989	08.1991	17 D	4	G 41
	1.7 D	1699	42	02.1989	08.1991	17 D	4	G 41
ASTRA Mk III (F)	1.7 D	1700	42	03.1992	09.1992	17 D	4	G 41
	1.7 D	1700	44	07.1992	09.1998	17 DR	4	G 41
	1.7 D	1700	42	03.1992	09.1992	17 D	4	G 41
	1.7 D	1700	44	07.1992	09.1998	17 DR	4	G 41
	1.7 D	1700	42	03.1992	09.1992	17 D	4	G 41
	1.7 D	1700	44	07.1992	09.1998	17 DR	4	G 41
	1.7 TD	1686	60	12.1991	09.1998	17 DT (TC4EE1)	4	G 67
	1.7 TD	1700	50	08.1994	09.1998	X 17 DTL	4	G 41
	1.7 TD	1700	50	08.1994	09.1998	X 17 DTL	4	G 41
	1.7 TD	1700	50	08.1994	09.1998	X 17 DTL	4	G 41
ASTRA Mk III (F) CC	1.7 D	1699	42	12.1991	02.1998	17 D	4	G 41
	1.7 D	1699	44	09.1991	12.1994	17 DR	4	G 41
	1.7 D	1699	42	12.1991	02.1998	17 D	4	G 41
	1.7 D	1699	44	09.1991	12.1994	17 DR	4	G 41
	1.7 D	1699	42	12.1991	02.1998	17 D	4	G 41
	1.7 D	1699	44	09.1991	12.1994	17 DR	4	G 41
	1.7 TD	1686	60	12.1991	02.1998	17 DT (TC4EE1)	4	G 67
	1.7 TD	1686	60	12.1991	02.1998	17 DT (TC4EE1)	4	G 48
	1.7 TD	1686	60	12.1991	02.1998	17 DT (TC4EE1)	4	G 46
	1.7 TD	1700	50	08.1994	02.1998	X 17 DTL	4	G 41
	1.7 TD	1686	60	12.1991	02.1998	17 DT (TC4EE1)	4	G 46
	1.7 TD	1686	60	12.1991	02.1998	17 DT (TC4EE1)	4	G 48
	1.7 TD	1700	50	08.1994	02.1998	X 17 DTL	4	G 41
	1.7 TD	1700	50	08.1994	02.1998	X 17 DTL	4	G 41
ASTRA Mk III (F) Estate	1.7 D	1699	44	03.1991	12.1994	17 DR	4	G 41
	1.7 D	1699	42	12.1991	02.1998	17 D	4	G 41
	1.7 D	1699	44	03.1991	12.1994	17 DR	4	G 41
	1.7 D	1699	42	12.1991	02.1998	17 D	4	G 41
	1.7 D	1699	44	03.1991	12.1994	17 DR	4	G 41
	1.7 D	1699	42	12.1991	02.1998	17 D	4	G 41
	1.7 TD	1686	60	12.1991	02.1998	17 DT (TC4EE1)	4	G 67
	1.7 TD	1686	60	12.1991	02.1998	17 DT (TC4EE1)	4	G 48
	1.7 TD	1686	60	12.1991	02.1998	17 DT (TC4EE1)	4	G 46
	1.7 TD	1700	50	01.1994	02.1998	X 17 DTL	4	G 41
	1.7 TD	1686	60	12.1991	02.1998	17 DT (TC4EE1)	4	G 46
	1.7 TD	1686	60	12.1991	02.1998	17 DT (TC4EE1)	4	G 48
	1.7 TD	1700	50	01.1994	02.1998	X 17 DTL	4	G 41
	1.7 TD	1700	50	01.1994	02.1998	X 17 DTL	4	G 41
ASTRA Mk IV (G)	1.7 CDTI 16V	1686	59	04.2003		Z 17 DTL	4	G 68
	1.7 DTI 16V	1686	55	02.2000		Y 17 DT	4	G 68
	1.7 TD	1700	50	09.1998	08.2000	X 17 DTL	4	G 41
	1.7 TD	1700	50	09.1998	08.2000	X 17 DTL	4	G 41
	1.7 TD	1700	50	09.1998	08.2000	X 17 DTL	4	G 41
	2.0 DI	1995	60	02.1998	07.2004	X 20 DTL/Y 20 DTL	4	G 56
	2.0 DTI 16V	1995	74	02.1998	07.2004	Y 20 DTH/X 20 DTH	4	G 3
	2.0 DTI 16V	1995	74	02.1998	07.2004	Y 20 DTH/X 20 DTH	4	G 56
	2.0 DTI 16V	1995	74	02.1998	07.2004	Y 20 DTH/X 20 DTH	4	G 3
	2.0 DTI 16V	1995	74	02.1998	07.2004	Y 20 DTH/X 20 DTH	4	G 56





kW



Cyl.



VAUXHALL

ASTRA Mk IV (G) CC	1.7 CDTi 16V	1686	59	04.2003		Z 17 DTL	4	G 68
	1.7 DTi 16V	1686	55	02.2000		Y 17 DT	4	G 68
	1.7 TD	1700	50	02.1998	08.2000	X 17 DTL	4	G 41
	1.7 TD	1700	50	02.1998	08.2000	X 17 DTL	4	G 41
	1.7 TD	1700	50	02.1998	08.2000	X 17 DTL	4	G 41
	2.0 DI	1995	60	02.1998		X 20 DTL/Y 20 DTL	4	G 56
	2.0 DTi 16V	1995	74	08.1999		Y 20 DTH/X 20 DTH	4	G 3
	2.0 DTi 16V	1995	74	08.1999		Y 20 DTH/X 20 DTH	4	G 56
	2.0 DTi 16V	1995	74	08.1999		Y 20 DTH/X 20 DTH	4	G 3
	2.0 DTi 16V	1995	74	08.1999		Y 20 DTH/X 20 DTH	4	G 56
ASTRA Mk IV (G) Estate	1.7 CDTi 16V	1686	59	04.2003		Z 17 DTL	4	G 68
	1.7 DTi 16V	1686	55	02.2000		Y 17 DT	4	G 68
	1.7 TD	1700	50	02.1998	08.2000	X 17 DTL	4	G 41
	1.7 TD	1700	50	02.1998	08.2000	X 17 DTL	4	G 41
	1.7 TD	1700	50	02.1998	08.2000	X 17 DTL	4	G 41
	2.0 DI	1995	60	03.1998	04.2004	X 20 DTL/Y 20 DTL	4	G 56
	2.0 DTi 16V	1995	74	03.1998	04.2004	Y 20 DTH/X 20 DTH	4	G 56
ASTRA Mk V (H) CC	1.3 CDTi	1248	66	01.2004	05.2009	Z 13 DTH	4	G 7
	1.7 CDTi	1686	74	01.2004	05.2009	Z 17 DTH	4	G 68
	1.7 CDTi	1686	59	01.2004	05.2009	Z 17 DTL	4	G 68
	1.9 CDTi	1910	88	01.2004	05.2009	Z 19 DT	4	G 60
	1.9 CDTi	1910	88	01.2004	05.2009	Z 19 DTJ	4	G 8
	1.9 CDTi	1910	110	01.2004	05.2009	Z 19 DTH	4	G 8
	1.9 CDTi	1910	110	01.2004	05.2009	Z 19 DTH	4	G 8
ASTRA Mk V (H) Estate	1.3 CDTi	1248	66	08.2004	03.2009	Z 13 DTH	4	G 7
	1.7 CDTi	1686	74	08.2004	03.2009	Z 17 DTH	4	G 68
	1.9 CDTi	1910	88	08.2004	03.2009	Z 19 DT	4	G 60
	NEW 1.9 CDTi	1910	74	08.2004	03.2009	Z 19 DTL	4	G 89
	NEW 1.9 CDTi	1910	88	08.2004	03.2009	Z 19 DT/Z19 DTJ	4	G 89
	1.9 CDTi	1910	88	08.2004	03.2009	Z 19 DT	4	G 8
	1.9 CDTi	1910	110	08.2004	03.2009	Z 19 DTH	4	G 8
ASTRA Mk V (H) Sport Hatch	1.7 CDTi	1686	74	02.2005		Z 17 DTH	4	G 68
	1.7 CDTi	1686	81	02.2007		A 17 DTJ	4	G 68
	NEW 1.9 CDTi	1910	74	08.2005	11.2010	Z 19 DTL	4	G 89
	1.9 CDTi	1910	88	02.2005		Z 19 DT	4	G 60
	NEW 1.9 CDTi	1910	88	02.2005	11.2010	Z 19 DT	4	G 89
	1.9 CDTi	1910	110	02.2005		Z 19 DTH	4	G 8
ASTRA TwinTop Mk V (H)	1.9 CDTi	1910	110	01.2006		Z 19 DTH	4	G 8
ASTRA Mk VI (J)	NEW 1.3 CDTi	1248	70	12.2009		A 13 DTE	4	GPE 80
	NEW 2.0 CDTi	1956	118	12.2009		A 20 DTH	4	GPE 82
	NEW 2.0 CDTi	1956	121	08.2011		A 20 DTH	4	GPE 82
	NEW 2.0 BiTurbo CDTi	1956	143	12.2012		A 20 DTR	4	GPE 82
	NEW 2.0 BiTurbo CDTi	1956	143	12.2012		A 20 DTR	4	GPE 82
ASTRA Mk VI (J) Saloon	NEW 1.3 CDTi	1248	70	06.2012		A 13 DTE	4	GPE 80
	NEW 2.0 BiTurbo CDTi	1956	143	12.2012		A 20 DTR	4	GPE 82
	NEW 2.0 BiTurbo CDTi	1956	143	12.2012		A 20 DTR	4	GPE 82
ASTRA Mk VI (J) Sports Tourer	NEW 1.3 CDTi	1248	70	10.2010		A 13 DTE	4	GPE 80
	NEW 2.0 CDTi	1956	118	12.2009		A 20 DTH	4	GPE 82
	NEW 2.0 CDTi	1956	121	08.2011		A 20 DTH	4	GPE 82
	NEW 2.0 BiTurbo CDTi	1956	143	12.2012		A 20 DTR	4	GPE 82
	NEW 2.0 BiTurbo CDTi	1956	143	12.2012		A 20 DTR	4	GPE 82
ASTRA GTC Mk VI (J)	NEW 2.0 CDTi	1956	121	10.2011		A 20 DTH	4	GPE 82
	NEW 2.0 BiTurbo CDTi	1956	143	12.2012		A 20 DTR	4	GPE 82
	NEW 2.0 BiTurbo CDTi	1956	143	12.2012		A 20 DTR	4	GPE 82
ASTRAVAN Mk III (F)	1.7 D	1699	44	01.1991	08.1994	17 DR	4	G 41
	1.7 D	1699	44	01.1991	08.1994	17 DR	4	G 41
	1.7 D	1699	44	01.1991	08.1994	17 DR	4	G 41
	1.7 TD	1700	50	01.1994	08.1998	X 17 DTL	4	G 41
	1.7 TD	1700	50	01.1994	08.1998	X 17 DTL	4	G 41
	1.7 TD	1700	50	01.1994	08.1998	X 17 DTL	4	G 41
	1.7 TD	1700	50	01.1994	08.1998	X 17 DTL	4	G 41
ASTRAVAN Mk IV (G)	1.7 CDTi	1686	59	04.2004		Z 17 DTL	4	G 68
	1.7 TD	1700	50	08.1998		X 17 DTL	4	G 41
	1.7 TD	1700	50	08.1998		X 17 DTL	4	G 41
	1.7 TD	1700	50	08.1998		X 17 DTL	4	G 41
	2.0 DI	1995	60	08.1998		X 20 DTL	4	G 56
	2.0 DTi	1995	74	04.2004		Y 20 DTH	4	G 56
ASTRAVAN Mk V (H)	1.3 CDTi	1248	66	08.2005		Z 13 DTH	4	G 7
	1.7 CDTi	1686	74	03.2005		Z 17 DTH	4	G 68
	1.9 CDTi	1910	88	03.2005		Z 19 DT	4	G 60
	NEW 1.9 CDTi	1910	88	03.2005	11.2011	Z 19 DT	4	G 89





kW



Cyl.



VAUXHALL

	1.9 CDTi	1910	110	03.2005		Z 19 DTH	4	G 8
BRAVA Pick-up	2.2 D (TFR52)	2238	39	08.1991	09.1996	C223	4	G 47
	2.2 D 4x4 (TFS52)	2238	39	08.1991	09.1996	C223	4	G 47
	2.5 D (TFR54)	2499	56	08.1991	06.1994	4 JA1	4	G 41
	2.5 D (TFR54)	2499	56	08.1991	06.1994	4 JA1	4	G 41
	2.5 D (TFR54)	2499	56	08.1991	06.1994	4 JA1	4	G 41
CARLTON Mk II	2.3 D	2260	52	05.1983	08.1986	23 D	4	G 41
	2.3 D	2260	52	05.1983	08.1986	23 D	4	G 41
	2.3 D	2260	52	05.1983	08.1986	23 D	4	G 41
CARLTON Mk II Estate	2.3 D	2260	52	05.1983	08.1986	23 D	4	G 41
	2.3 D	2260	52	05.1983	08.1986	23 D	4	G 41
	2.3 D	2260	52	05.1983	08.1986	23 D	4	G 41
CARLTON Mk III	2.2 TD	2260	66	10.1986	08.1988	23 YDT	4	G 41
	2.2 TD	2260	66	10.1986	08.1988	23 YDT	4	G 41
	2.2 TD	2260	66	10.1986	08.1988	23 YDT	4	G 41
	2.3 D	2260	54	09.1986	03.1994	23 YD	4	G 41
	2.3 D	2260	54	09.1986	03.1994	23 YD	4	G 41
	2.3 D	2260	54	09.1986	03.1994	23 YD	4	G 41
	2.3 TD Interc.	2260	74	08.1988	03.1994	23 DTR	4	G 41
	2.3 TD Interc.	2260	74	08.1988	03.1994	23 DTR	4	G 41
	2.3 TD Interc.	2260	74	08.1988	03.1994	23 DTR	4	G 41
	CARLTON Mk III Estate	2.2 TD	2260	66	09.1986	08.1988	23 YDT	4
2.2 TD		2260	66	09.1986	08.1988	23 YDT	4	G 41
2.2 TD		2260	66	09.1986	08.1988	23 YDT	4	G 41
2.3 D		2260	54	09.1986	03.1994	23 YD	4	G 41
2.3 D		2260	54	09.1986	03.1994	23 YD	4	G 41
2.3 D		2260	54	09.1986	03.1994	23 YD	4	G 41
2.3 TD Interc.		2260	74	09.1988	03.1994	23 DTR	4	G 41
2.3 TD Interc.		2260	74	09.1988	03.1994	23 DTR	4	G 41
2.3 TD Interc.		2260	74	09.1988	03.1994	23 DTR	4	G 41
CAVALIER Mk II		1.6 D	1598	40	03.1982	08.1988	16 DA/16 D	4
	1.6 D	1598	40	03.1982	08.1988	16 DA/16 D	4	G 41
	1.6 D	1598	40	03.1982	08.1988	16 DA/16 D	4	G 41
CAVALIER Mk II CC	1600D	1598	40	03.1982	08.1988	16 DA/16 D	4	G 41
	1600D	1598	40	03.1982	08.1988	16 DA/16 D	4	G 41
	1600D	1598	40	03.1982	08.1988	16 DA/16 D	4	G 41
CAVALIER Mk II Estate	1.6 D	1598	40	03.1982	08.1988	16 DA	4	G 41
	1.6 D	1598	40	03.1982	08.1988	16 DA	4	G 41
	1.6 D	1598	40	03.1982	08.1988	16 DA	4	G 41
CAVALIER Mk III (87)	1.7 D	1699	42	09.1988	09.1992	17 D	4	G 41
	1.7 D	1699	42	09.1988	09.1992	17 D	4	G 41
	1.7 D	1699	42	09.1988	09.1992	17 D	4	G 41
	1.7 D	1700	44	07.1992	11.1995	17 DR	4	G 41
	1.7 D	1700	44	07.1992	11.1995	17 DR	4	G 41
	1.7 D	1700	44	07.1992	11.1995	17 DR	4	G 41
	1.7 TD	1686	60	09.1988	11.1995	17 DT (TC4EE1)	4	G 67
	1.7 TD	1686	60	09.1988	11.1995	17 DT (TC4EE1)	4	G 47
	1.7 TD	1686	60	09.1988	11.1995	17 DT (TC4EE1)	4	G 47
	1.7 TD	1686	60	09.1988	11.1995	17 DT (TC4EE1)	4	G 47
CAVALIER Mk III CC	1.7 D	1699	42	09.1988	09.1992	17 D	4	G 41
	1.7 D	1699	42	09.1988	09.1992	17 D	4	G 41
	1.7 D	1699	42	09.1988	09.1992	17 D	4	G 41
	1.7 D	1700	44	07.1992	11.1995	17 DR	4	G 41
	1.7 D	1700	44	07.1992	11.1995	17 DR	4	G 41
	1.7 D	1700	44	07.1992	11.1995	17 DR	4	G 41
	1.7 TD	1686	60	09.1988	11.1995	17 DT (TC4EE1)	4	G 67
	1.7 TD	1686	60	09.1988	11.1995	17 DT (TC4EE1)	4	G 47
	1.7 TD	1686	60	09.1988	11.1995	17 DT (TC4EE1)	4	G 47
	1.7 TD	1686	60	09.1988	11.1995	17 DT (TC4EE1)	4	G 47
COMBO Mk I (B)	1.7 D	1686	44	07.1994	10.2001	17 D (4EE1)/X 17 D (4EE1)	4	G 67
COMBO Mk II (C)	1.3 CDTI 16V	1248	55	10.2005		Z 13 DTJ	4	G 7
	1.7 CDTI 16V	1686	74	12.2004		Z 17 DTH	4	G 68
	1.7 DI 16V	1686	48	09.2001		Y 17 DTL	4	G 68
	1.7 DTI 16V	1686	55	10.2001		Y 17 DT	4	G 68
COMBO Mk III (D)	NEW 1.6 CDTI	1598	66	11.2011		A 16 FDL	4	GPE 82
	NEW 1.6 CDTI	1598	74	11.2011		A 16 FDH	4	GPE 82
	NEW 1.6 CDTI	1598	77	11.2011		A 16 FDH	4	GPE 82

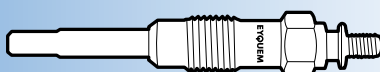



kW



Cyl.



VAUXHALL

	NEW	2.0 CDTI	1598	99	11.2011		A 20 FD	4	GPE 82
CORSA Mk II (B)		1.5 D	1488	37	03.1993	09.2000	15 D	4	G 67
		1.5 TD	1488	49	03.1993	10.1996	X 15 DT (T4EC1)/15 DT (T4EC1)	4	G 67
		1.7 D	1686	44	02.1996	09.2000	17 D (4EE1)/X 17 D (4EE1)	4	G 67
CORSA Mk III (C)		1.3 CDTI 16V	1248	52	08.2000	09.2006	Z 13 DT	4	G 7
		1.7 CDTI 16V	1686	74	08.2000	09.2006	Z 17 DTH	4	G 68
		1.7 DI 16V	1686	48	08.2000	09.2006	Y 17 DTL	4	G 68
		1.7 DTI 16V	1686	55	08.2000	09.2006	Y 17 DT	4	G 68
CORSA Mk IV (D)		1.3 CDTI	1248	55	11.2006		A 13 DTC/Z 13 DTJ	4	G 7
		1.3 CDTI	1248	66	11.2006		Z 13 DTH	4	G 7
CORSAVAN Mk II (B)		1.7 D	1686	44	01.1994	09.2000	17 D (4EE1)/X 17 D (4EE1)	4	G 67
CORSAVAN Mk III (C)		1.3 CDTI 16V	1248	52	04.2004		Z 13 DT	4	G 7
		1.7 DI 16V	1686	48	09.2000		Y 17 DTL	4	G 68
		1.7 DTI 16V	1686	55	09.2000		Y 17 DT	4	G 68
CORSAVAN Mk IV (D)		1.3 CDTI	1248	55	07.2006		Z 13 DTJ	4	G 7
	NEW	1.3 CDTI	1248	70	07.2006		Z 13 DTE	4	GPE 80
FRONTERA Mk I (A)		2.3 TD	2260	74	03.1992	10.1998	23 DTR	4	G 41
		2.3 TD	2260	74	03.1992	10.1998	23 DTR	4	G 41
		2.3 TD	2260	74	03.1992	10.1998	23 DTR	4	G 41
		2.5 TDS	2499	85	09.1996	10.1998	25TDS (VM41B)	4	G 40
FRONTERA Mk I (A) Sport		2.5 TDS	2499	85	09.1996	10.1998	25TDS (VM41B)	4	G 40
FRONTERA Mk II (B)		2.2 DTI	2171	85	10.1998	09.2004	X 22 DTH/Y 22 DTH	4	G 3
		2.2 DTI	2171	85	10.1998	09.2004	X 22 DTH/Y 22 DTH	4	G 56
INSIGNIA	NEW	2.0 CDTI	1956	81	07.2008		A 20 DTC/A 20 DTL	4	GPE 82
	NEW	2.0 CDTI	1956	96	07.2008		A 20 DT/A 20 DTJ	4	GPE 82
	NEW	2.0 CDTI	1956	118	07.2008		A 20 DTH	4	GPE 82
INSIGNIA Saloon	NEW	2.0 CDTI	1956	81	07.2008		A 20 DTC/A 20 DTL	4	GPE 82
	NEW	2.0 CDTI	1956	96	07.2008		A 20 DT/A 20 DTJ	4	GPE 82
	NEW	2.0 CDTI	1956	118	07.2008		A 20 DTH	4	GPE 82
INSIGNIA Sports Tourer	NEW	2.0 CDTI	1956	81	07.2008		A 20 DTC/A 20 DTL	4	GPE 82
	NEW	2.0 CDTI	1956	96	07.2008		A 20 DT/A 20 DTJ	4	GPE 82
	NEW	2.0 CDTI	1956	118	07.2008		A 20 DTH	4	GPE 82
MERIVA Mk I (A)		1.3 CDTI	1248	55	01.2003	10.2009	Z 13 DTJ	4	G 7
		1.7 CDTI	1686	92	08.2006		Z 17 DTR	4	G 68
		1.7 CDTI 16V	1686	74	04.2004	08.2005	Z 17 DTH	4	G 68
MERIVA Mk II (B)	NEW	1.3 CDTI	1248	55	06.2010		A 13 DTC	4	GPE 80
	NEW	1.3 CDTI	1248	70	06.2010		A 13 DTE	4	GPE 80
MIDI II		2.4 TD	2380	56	09.1994		4FG1T	4	G 46
		2.4 TD	2380	56	09.1994		4FG1T	4	G 48
		2.4 TD 4x4	2389	56	01.1994	07.1996	4FG1T	4	G 46
		2.4 TD 4x4	2389	56	01.1994	07.1996	4FG1T	4	G 48
MOVANO Mk I (A) Chassis/ Cab (ED, UD, HD)		2.2 DTI	2188	66	09.2000		G9T 722/G9T 720/G9T 750	4	G 63
		2.5 CDTI	2463	74	04.2004		G9U 754	4	G 63
		2.5 D	2499	59	10.1998	09.2000	S8U 770	4	G 35
		2.5 DTI	2463	84	10.2001		G9U 754/G9U 724/G9U 720	4	G 63
		1.9 DTI	1870	59	09.2000	10.2001	F9Q 770	4	G 28
MOVANO Mk I (A) Combi (JD)		1.9 DTI	1870	60	10.2001		F9Q 774	4	G 28
		2.2 DTI	2188	66	09.2000		G9T 720/G9T 750	4	G 63
		2.5 CDTI	2463	74	10.2001	08.2009	G9U 754	4	G 63
		2.5 D	2499	59	10.1998	09.2000	S8U 770	4	G 35
		2.5 DTI	2463	84	10.2001	08.2009	G9U 750/G9U 754/G9U 720	4	G 63
		1.9 DTI	1870	59	09.2000	10.2001	F9Q 770	4	G 28
MOVANO Mk I (A) Van (FD)		1.9 DTI	1870	60	10.2001		F9Q 774	4	G 28
		2.2 DTI	2188	66	09.2000		G9T 722/G9T 720/G9T 750	4	G 63
		2.5 CDTI	2463	74	04.2004		G9U 754	4	G 63
		2.5 D	2499	59	10.1998	09.2000	S8U 770	4	G 35
		2.5 DTI	2463	84	10.2001		G9U 750/G9U 754/G9U 720	4	G 63
		1.5 D	1488	37	09.1987	02.1993	15 D	4	G 47
NOVA		1.5 TD	1488	49	01.1990	02.1993	15 DT (T4EC1)	4	G 48
		1.5 TD	1488	49	01.1990	02.1993	15 DT (T4EC1)	4	G 46
		1.5 TD	1488	49	01.1990	02.1993	15 DT (T4EC1)	4	G 46
		1.5 TD	1488	49	01.1990	02.1993	15 DT (T4EC1)	4	G 48
NOVA CC		1.5 D	1488	37	09.1987	03.1993	15 D	4	G 47
		1.5 TD	1488	49	01.1990	03.1993	15 DT (T4EC1)	4	G 48

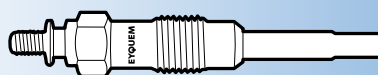



kW



Cyl.



VAUXHALL

	1.5 TD	1488	49	01.1990	03.1993	15 DT (T4EC1)	4	G 46
	1.5 TD	1488	49	01.1990	03.1993	15 DT (T4EC1)	4	G 46
	1.5 TD	1488	49	01.1990	03.1993	15 DT (T4EC1)	4	G 48
NOVAVAN	1.5 D	1488	37	01.1991	10.1994	15 D	4	G 47
OMEGA (B)	2.0 DTI 16V	1995	74	01.1998	09.2000	X 20 DTH	4	G 56
	2.2 DTI 16V	2171	88	08.2000	03.2004	Y 22 DTH	4	G 3
	2.5 DTI 24V	2497	110	09.2001		Y 25 DT	6	G 23
	2.5 TD	2497	96	04.1994	02.2001	25 DT/X 25 DT	6	G 41
	2.5 TD	2497	96	04.1994	02.2001	25 DT/X 25 DT	6	G 41
	2.5 TD	2497	96	04.1994	02.2001	25 DT/X 25 DT	6	G 41
OMEGA (B) Estate	2.0 DTI 16V	1995	74	01.1998	09.2000	X 20 DTH	4	G 56
	2.2 DTI 16V	2171	88	08.2000	03.2004	Y 22 DTH	4	G 3
	2.5 DTI 24V	2497	110	09.2001		Y 25 DT	6	G 23
	2.5 TD	2497	96	04.1994	02.2001	25 DT/X 25 DT	6	G 41
	2.5 TD	2497	96	04.1994	02.2001	25 DT/X 25 DT	6	G 41
	2.5 TD	2497	96	04.1994	02.2001	25 DT/X 25 DT	6	G 41
ROYALE	2.2 TD	2260	63	11.1984	08.1987	23 TD	4	G 41
	2.2 TD	2260	63	11.1984	08.1987	23 TD	4	G 41
	2.2 TD	2260	63	11.1984	08.1987	23 TD	4	G 41
SIGNUM	NEW 1.9 Turbo	1910	74	01.2005	05.2008	Z 19 DTL	4	G 89
	NEW 1.9 CDTI	1910	88	04.2004	03.2008	Z 19 DT	4	G 89
	1.9 CDTI 16V	1910	110	04.2004	03.2008	Z 19 DTH	4	G 8
	2.0 DTI	1994	74	05.2003		Y 20 DTH	4	G 3
	2.2 DTI	2172	92	05.2003		Y 22 DTR	4	G 3
SINTRA	2.2 DTI	2171	85	07.1997	04.1999	X 22 DTH	4	G 56
TIGRA TwinTop	1.3 CDTI	1248	51	06.2004		Z 13 DT	4	G 7
VECTRA (B)	1.7 TD	1686	60	10.1995	11.1996	X 17 DT (TC4EE1)	4	G 67
	2.0 DI 16V	1995	60	08.1995	10.2001	X 20 DTL	4	G 56
	2.0 DI 16V	1995	60	08.1995	10.2001	X 20 DTL	4	G 52
	2.0 DTI 16V	1995	74	08.1995	10.2001	Y 20 DTH/X 20 DTH	4	G 3
	2.0 DTI 16V	1995	74	08.1995	10.2001	Y 20 DTH/X 20 DTH	4	G 56
	2.2 DTI 16V	2172	92	08.1995	10.2001	Y 22 DTR	4	G 3
VECTRA (B) CC	1.7 TD	1686	60	10.1995	11.1996	X 17 DT (TC4EE1)	4	G 67
	2.0 Di 16V	1995	60	08.1995	10.2001	X 20 DTL	4	G 56
	2.0 Di 16V	1995	60	08.1995	10.2001	X 20 DTL	4	G 52
	2.0 DTI 16V	1995	74	06.1997	10.2001	Y 20 DTH/X 20 DTH	4	G 3
	2.0 DTI 16V	1995	74	06.1997	10.2001	Y 20 DTH/X 20 DTH	4	G 56
	2.2 DTI 16V	2172	92	08.1995	10.2001	Y 22 DTR	4	G 3
VECTRA (B) Estate	2.0 DI 16V	1995	60	08.1995	10.2001	X 20 DTL	4	G 56
	2.0 DI 16V	1995	60	08.1995	10.2001	X 20 DTL	4	G 52
	2.0 DTI 16V	1995	74	08.1995	10.2001	Y 20 DTH/X 20 DTH	4	G 3
	2.0 DTI 16V	1995	74	08.1995	10.2001	Y 20 DTH/X 20 DTH	4	G 56
	2.2 DTI 16V	2172	92	08.1995	10.2001	Y 22 DTR	4	G 3
VECTRA Mk II (C)	1.9 CDTI	1910	74	10.2005	07.2008	Z 19 DTL	4	G 60
	NEW 1.9 CDTI	1910	88	04.2002	09.2008	Z 19 DT	4	G 89
	1.9 CDTI	1910	88	04.2004	08.2005	Z 19 DT	4	G 60
	1.9 CDTI 16V	1910	110	04.2004	08.2005	Z 19 DTH	4	G 8
	2.0 DTI 16V	1995	74	04.2002		Y 20 DTH	4	G 3
	2.2 DTI 16V	2172	92	04.2002		Y 22 DTR	4	G 3
VECTRA Mk II (C) Estate	1.9 CDTI	1910	74	10.2005	07.2008	Z 19 DTL	4	G 60
	1.9 CDTI	1910	88	04.2004	08.2005	Z 19 DT	4	G 60
	NEW 1.9 CDTI	1910	88	04.2004	07.2008	Z 19 DT	4	G 89
	1.9 CDTI 16V	1910	110	04.2004	08.2005	Z 19 DTH	4	G 8
	2.0 DTI 16V	1995	74	10.2003	07.2008	Y 20 DTH	4	G 3
	2.2 DTI 16V	2172	92	10.2003	07.2008	Y 22 DTR	4	G 3
VECTRA Mk II (C) GTS	1.9 CDTI	1910	74	10.2005	07.2008	Z 19 DTL	4	G 60
	1.9 CDTI	1910	88	04.2004	08.2005	Z 19 DT	4	G 60
	NEW 1.9 CDTI	1910	88	08.2002	07.2008	Z 19 DT	4	G 89
	1.9 CDTI 16V	1910	110	04.2004	08.2005	Z 19 DTH	4	G 8
	2.0 DTI 16V	1995	74	08.2002	07.2008	Y 20 DTH	4	G 3
	2.2 DTI 16V	2172	92	08.2002	07.2008	Y 22 DTR	4	G 3
VIVARO Combi	1.9 DI	1900	59	08.2001			4	G 28
	1.9 DTI	1870	74	08.2001		F9Q 760	4	G 28
	2.5 DTI	2463	99	04.2004		G9U 730	4	G 63
VIVARO Camionnette	1.9 DI	1900	59	08.2001			4	G 28





kW



Cyl.



VAUXHALL

	1.9 DTI	1870	74	08.2001		F9Q 760	4	G 28
	2.5 DTI	2463	99	04.2004		G9U 730	4	G 63
VIVARO Camion/Plate-forme	2.5 CDTI	2463	107	08.2006		G9U 730	4	G 63
ZAFIRA Mk I (A)	2.0 DI 16V	1995	60	10.1999		X 20 DTL	4	G 56
	2.0 DTI 16V	1995	74	04.1999	08.2005	Y 20 DTH	4	G 56
	2.2 D	2172	92	06.2001	06.2005	Y 22 DTR	4	G 3
ZAFIRA Mk II (B)	1.7 CDTI	1686	81	04.2009		Z 17 DTJ	4	G 68
	NEW 1.9 CDTI	1910	74	07.2005		Z 19 DTL	4	G 89
	NEW 1.9 CDTI	1910	88	07.2005		Z 19 DT	4	G 89
	1.9 CDTI	1910	110	07.2005		Z 19 DTH	4	G 8
ZAFIRA Mk III (P12)	NEW 1.6 CDTI	1598	100	03.2013		B 16 DTH	2	GPE 94
	NEW 2.0 CDTI	1956	81	10.2011		A 20 DTL	4	GPE 82
	NEW 2.0 CDTI	1956	96	10.2011		A 20 DT/Y 20 DT/JZ 20 DTJ	4	GPE 82

VOLVO

240 (P242, P244)	2.4 Diesel	2383	58	08.1987	08.1993	D 24	6	G 17
	2.4 Diesel	2383	60	08.1978	07.1985	D 24	6	G 17
240 Kombi (P245)	2.4 Diesel	2383	58	08.1988	08.1993	D 24	6	G 17
	2.4 Diesel	2383	60	04.1979	08.1993	D 24	6	G 17
340-360 (343, 345)	1.6 Diesel	1596	40	08.1984	07.1991	D 16	4	G 27
340-360 Tricorps (344)	1.6 Diesel	1596	40	08.1984	07.1991	D 16	4	G 27
440 K (445)	1.9 Turbo-Diesel	1870	66	07.1994	12.1996	D 19 T	4	G 49
	1.9 Turbo-Diesel	1870	66	07.1994	12.1996	D 19 T	4	G 49
460 L (464)	1.9 Turbo-Diesel	1870	66	07.1994	07.1996	D 19 T	4	G 49
	1.9 Turbo-Diesel	1870	66	07.1994	07.1996	D 19 T	4	G 49
740 (744)	2.4 Diesel	2383	60	08.1984	07.1992	D 24	6	G 17
	2.4 TD	2383	80	08.1985	07.1987	D 24 T	6	G 17
	2.4 TD	2383	83	08.1984	07.1990	D 24 T	6	G 17
	2.4 TD	2383	90	08.1986	10.1988	D 24 TIC	6	G 17
740 Kombi (745)	2.4 Diesel	2383	60	08.1985	07.1988	D 24	6	G 17
	2.4 TD Interc.	2383	90	08.1986	07.1988	D 24 TIC	6	G 17
	2.4 Turbo-Diesel	2383	80	09.1985	07.1992	D 24 T	6	G 17
760 (704, 764)	2.4 D	2383	60	01.1982	07.1992	D 24	6	G 17
	2.4 TD Interc. (704)	2383	85	08.1987	07.1992	D 24 TIC	6	G 17
	2.4 Turbo Diesel (704)	2383	80	04.1987	07.1992	D 24 T	6	G 17
	2.4 Turbo Diesel (704)	2383	82	08.1982	07.1987	D 24 T	6	G 17
760 Kombi (704, 765)	2.4 D	2383	60	01.1982	07.1992	D 24	6	G 17
	2.4 TD Interc. (765)	2383	85	08.1987	07.1992	D 24 TIC	6	G 17
850 (LS)	2.5 TDI	2461	103	08.1995	12.1996	D 5252 T	5	G 37
850 Kombi (LW)	2.5 TDI	2461	103	08.1995	12.1996	D 5252 T	5	G 37
940 (944)	2.4 D	2383	60	08.1990	12.1994	D 24	6	G 17
	2.4 TD Intercooler	2383	90	08.1990	12.1994	D 24 TIC	6	G 17
	2.4 Turbo Diesel	2383	80	08.1990	12.1994	D 24 T	6	G 17
940 II (944)	2.4 TD Interc.	2383	90	08.1994	10.1998	D 24 TIC	6	G 17
940 II Kombi (945)	2.4 TD Interc.	2383	90	08.1994	10.1998	D 24 TIC	6	G 17
940 Kombi (945)	2.4 D	2383	60	08.1990	07.1995	D 24	6	G 17
	2.4 TD Intercooler	2383	90	08.1990	08.1994	D 24 TIC	6	G 17
	2.4 Turbo Diesel	2383	80	08.1990	07.1994	D 24 T	6	G 17
960 (964)	2.4 TD Interc.	2383	85	09.1991	07.1994	D 24 TIC	6	G 17
960 Kombi (965)	2.4 TD Interc.	2383	85	09.1991	07.1994	D 24 TIC	6	G 17
C30	2.0 D	1998	100	10.2006		D 4204 T	4	G 30
C70 II Cabriolet	2.0 D	1997	100	01.2008		D 4204 T	4	G 30
S40 I (VS)	1.9 DI	1870	75	07.2000	12.2003	D 4192 T4	4	G 28
	1.9 DI	1870	85	07.2000	12.2003	D 4192 T3	4	G 28
	1.9 DI	1870	70	03.1999	07.2000	D 4192 T2	4	G 51
	1.9 TD	1870	66	07.1995	08.1999	D 4192 T	4	G 49
S40 II (MS)	1.6 D	1560	81	01.2005		D 4164 T	4	G 6
	2.0 D	1998	100	01.2004		D 4204 T	4	G 30
S60	2.4 D	2401	96	12.2001		D 5244 T2	5	G 5
	2.4 D5	2401	120	07.2001		D 5244 T	5	G 5
S70 (P80_)	2.5 TDI	2461	103	01.1997	11.2000	D 5252 T	5	G 37
S80 (TS, XY)	2.4 D	2401	96	10.2001	07.2006	D 5244 T2	5	G 5
	2.4 D5	2401	120	08.2001	07.2006	D 5244 T	5	G 5
	2.5 TDI	2461	103	01.1999	07.2006	D 5252 T	5	G 37
S80 II	2.0 TDi	1997	100	02.2008		D 4204 T	4	G 30





kW



Cyl.

**VOLVO**

V40 Kombi (VW)	1.9 DI	1870	75	07.2000	06.2004	D 4192 T4	4	G 28
	1.9 DI	1870	85	07.2000	06.2004	D 4192 T3	4	G 28
	1.9 DI	1870	70	03.1999	07.2000	D 4192 T2	4	G 51
	1.9 TD	1870	66	07.1995	08.1999	D 4192 T	4	G 49
	2.0 D	1998	100	12.2002	06.2004	D 4204 T	4	G 30
V50 (MW)	1.6 D	1560	81	01.2005		D 4164 T	4	G 6
	2.0 D	1998	100	04.2004		D 4204 T	4	G 30
V70 I Kombi (P80_)	2.5 TDI	2461	103	01.1997	05.2000	D 5252 T	5	G 37
V70 II Kombi (P80_)	2.4 D	2401	96	12.2001		D 5244 T2	5	G 5
	2.4 D5	2401	120	08.2001		D 5244 T	5	G 5
	2.4 D5 AWD	2401	120	03.2003		D 5244 T2	5	G 5
	2.5 TDI	2461	103	03.2000		D 5252 T	5	G 37
V70 III Kombi	2.0 D	1997	100	10.2007		D 4204 T	4	G 30
XC 90	D5	2401	120	10.2002		D 5244 T	5	G 5
XC70 CROSS COUNTRY	2.4 D5 XC AWD	2401	120	09.2002		D 5244 T	5	G 5

VOLKSWAGEN

AMAROK (2HA, 2HB, S1B, S6B,...)	2.0 TDI	1968	90	09.2010		CDBA	4	GPE 74
	2.0 TDI 4motion	1968	90	09.2010		CDBA	4	GPE 74
	NEW 2.0 TDI	1968	103	07.2012		CNFB	4	GPE 74
	NEW 2.0 TDI 4motion	1968	103	06.2012		CNFB	4	GPE 74
	2.0 BITDI	1968	120	09.2010		CDC A	4	GPE 74
	2.0 BITDI 4motion	1968	120	09.2010		CDC A	4	GPE 74
	NEW 2.0 BITDI	1968	132	11.2011		CNEA/CSHA	4	GPE 74
	NEW 2.0 BITDI 4motion	1968	132	11.2011		CNEA/CSHA	4	GPE 74
	NEW 3.0 TDI, 4motion	2967	120	06.2016		DDXA	5	GPE 74
	NEW 3.0 TDI 4motion	2967	150	06.2016		DDXB	5	GPE 74
	NEW 3.0 TDI 4motion	2967	165	06.2016		DDXC	5	GPE 74
AMAROK Camion/plateforme(S1B)	NEW 2.0 TDI	1968	103	09.2011		CNFB	4	GPE 74
	NEW 2.0 TDI	1968	132	09.2011		CNEA/CSHA	4	GPE 74
ARTEON (3H7)	NEW 2.0 TDI	1968	110	04.2017		DFGA	3	GPE 74
	NEW 2.0 TDI	1968	140	05.2017		DFHA	3	GPE 74
	NEW 2.0 TDI 4motion	1968	140	05.2017		DFHA	3	GPE 74
	NEW 2.0 TDI 4motion	1968	176	04.2017		CUAA	3	GPE 74
BEETLE (5C1,5C2)	1.6 TDI	1598	77	10.2011		CAYC	4	GPE 74
	NEW 2.0 TDI	1968	81	06.2014		CUJA	4	GPE 74
	2.0 TDI	1968	103	04.2011		CFFB	4	GPE 74
	NEW 2.0 TDI	1968	110	07.2014		CUUB/CVCA	4	GPE 74
BEETLE Cabriolet (5C7, 5C8)	NEW 1.6 TDI	1598	77	12.2011		CAYC	4	GPE 74
	NEW 2.0 TDI	1968	81	06.2014		CUJA	4	GPE 74
	NEW 2.0 TDI	1968	103	04.2012		CFFB	4	GPE 74
	NEW 2.0 TDI	1968	110	07.2014		CUUB/CVCA	4	GPE 74
BORA (1J2)	1.9 SDI	1896	50	10.1998	05.2005	AGP/AQM	4	G 37
	1.9 TDI	1896	66	10.1998	05.2005	AGR/ALH	4	G 37
	1.9 TDI 4motion	1896	66	11.1998	04.2002	AGR	4	G 37
	1.9 TDI	1896	74	09.2000	05.2005	AXR/ATD	4	G 37
	1.9 TDI	1896	74	09.2000	05.2005	AXR/ATD	4	G 4
	1.9 TDI	1896	81	10.1998	06.2001	AHF/ASV	4	G 37
	1.9 TDI	1896	85	12.1998	01.2002	AJM/AUY	4	G 37
	1.9 TDI 4motion	1896	85	02.1999	06.2001	AJM/AUY	4	G 37
	1.9 TDI, 4motion	1896	96	11.2000	05.2005	ASZ	4	G 37
	1.9 TDI, 4motion	1896	96	11.2000	05.2005	ASZ	4	G 4
	1.9 TDI, 4motion	1896	110	05.2000	09.2001	ARL	4	G 37
	1.9 TDI, 4motion	1896	110	10.2001	05.2005	ARL	4	G 4
BORA Kombi (1J6)	1.9 TDI	1896	66	07.2004	05.2005	AGR/ALH	4	G 37
	1.9 TDI	1896	74	09.2000	10.2001	AXR/ATD	4	G 37
	1.9 TDI	1896	74	11.2001	05.2005	AXR/ATD	4	G 4
	1.9 TDI 4motion	1896	74	09.2000	04.2001	ATD	4	G 37
	1.9 TDI 4motion	1896	74	05.2001	05.2005	ATD	4	G 4
	1.9 TDI	1896	81	05.1999	06.2001	AHF/ASV	4	G 37
	1.9 TDI, 4motion	1896	85	05.1999	06.2001	AJM	4	G 37
	1.9 TDI, 4motion	1896	85	05.1999	06.2001	AUY	4	G 4
	1.9 TDI, 4motion	1896	96	11.2000	10.2001	ASZ	4	G 37
	1.9 TDI, 4motion	1896	96	11.2001	05.2005	ASZ	4	G 4
	1.9 TDI, 4motion	1896	110	05.2001	05.2005	ARL	4	G 37

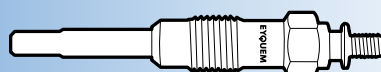



kW



Cyl.



VOLKSWAGEN

	1.9 TDI, 4motion	1896	110	05.2001	05.2005	ARL	4	G 4
CADDY I (14)	1.6 D	1588	40	08.1982	07.1992	JK/ME	4	G 17
CADDY II Camionnette (9K9A)	1.7 SDI	1716	42	07.1996	09.2000	AHB	4	G 37
	1.9 D	1896	47	11.1995	01.2004	1Y	4	G 17
	1.9 SDI	1896	47	11.1995	01.2004	AYQ/AEY	4	G 37
	1.9 TDI	1896	66	09.1996	01.2004	1Z/AHU/ALH	4	G 37
	1.9 TDI	1896	66	09.1996	01.2004	1Z/AHU/ALH (auxiliary heating)	4	G 17
CADDY II Camionnette (9K9B)	1.7 SDI	1716	42	07.1996	09.2000	AHB	4	G 37
	1.9 D	1896	47	11.1995	01.2004	1Y	4	G 17
	1.9 SDI	1896	47	11.1995	01.2004	AYQ/AEY	4	G 37
	1.9 TDI	1896	66	10.1996	01.2004	ALE/AHU/ALH	4	G 37
	1.9 TDI	1896	66	10.1996	01.2004	ALE/AHU/ALH (auxiliary heating)	4	G 17
CADDY II Pick-up (9U7)	1.9 D	1896	47	06.1996	12.2000	AEF	4	G 17
CADDY III Camionnette (2KA, 2KH, 2CA, 2CH)	1.6 TDI	1598	55	08.2010		CAYE	4	GPE 74
	1.6 TDI	1598	75	08.2010		CAYD	4	GPE 74
	1.9 TDI	1896	55	09.2005	08.2010	BSU	4	GPE 70
	1.9 TDI, 4motion	1896	77	04.2004	08.2010	BJB/BLS	4	GPE 70
	2.0 SDI	1968	51	03.2004	08.2010	BST/BDJ	4	G 4
	NEW 2.0 TDI, 4motion	1968	62	11.2010		CFHE	4	GPE 74
	2.0 TDI, 4motion	1968	81	10.2010		CLCA/CFHF	4	GPE 74
	2.0 TDI	1968	103	09.2007	08.2010	BMM	4	GPE 70
	2.0 TDI 16V, 4motion	1968	103	11.2010		CFHC/CLCB	4	GPE 74
	NEW 2.0 TDI	1968	125	05.2012		CFJA	4	GPE 74
CADDY III Kombi (2KB, 2KJ)	1.6 TDI	1598	55	08.2010		CAYE	4	GPE 74
	1.6 TDI	1598	75	08.2010		CAYD	4	GPE 74
	1.9 TDI	1896	55	09.2005	08.2010	BSU	4	GPE 70
	1.9 TDI	1896	77	04.2004	08.2010	BJB/BLS	4	GPE 70
	1.9 TDI 4motion	1896	77	05.2008	08.2010	BLS	4	GPE 70
	2.0 SDI	1968	51	03.2004	08.2010	BST/BDJ	4	G 4
	2.0 TDI 4motion	1968	81	10.2010		CLCA/CFHF	4	GPE 74
	2.0 TDI	1968	103	09.2007	08.2010	BMM	4	GPE 70
	2.0 TDI 16V, 4motion	1968	103	11.2010		CFHC/CLCB	4	GPE 74
	NEW 2.0 TDI	1968	125	05.2012		CFJA	4	GPE 74
CADDY IV ALLTRACK Box (SAA)	NEW 2.0 TDI	1968	55	05.2015		CUUF/DFSF	4	GPE 74
	NEW 2.0 TDI	1968	75	05.2015		CUUD/DFSD	4	GPE 74
	NEW 2.0 TDI 4motion	1968	92	05.2015		CUUE/DFSE	4	GPE 74
	NEW 2.0 TDI	1968	110	05.2015		CUUB/DFSB	4	GPE 74
	NEW 2.0 TDI 4motion	1968	110	11.2015		DFSB	4	GPE 74
CADDY IV ALLTRACK Estate (SAB)	NEW 2.0 TDI	1968	55	05.2015		CUUF/DFSF	4	GPE 74
	NEW 2.0 TDI	1968	75	05.2015		CUUD/DFSD	4	GPE 74
	NEW 2.0 TDI 4motion	1968	92	05.2015		CUUE/DFSE	4	GPE 74
	NEW 2.0 TDI	1968	110	05.2015		CUUB/DFSB	4	GPE 74
	NEW 2.0 TDI 4motion	1968	110	11.2015		DFSB	4	GPE 74
CADDY IV Camionnette (SAA, SAH)	NEW 1.6 TDI	1598	55	05.2015		CAYE	4	GPE 74
	NEW 1.6 TDI	1598	75	05.2015		CAYD	4	GPE 74
	NEW 2.0 TDI	1968	55	05.2015		CUUF/DFSC/DFSF	4	GPE 74
	NEW 2.0 TDI 4motion	1968	55	11.2015		DFSC	4	GPE 74
	NEW 2.0 TDI	1968	75	05.2015		CUUD/DFSD	4	GPE 74
	NEW 2.0 TDI	1968	81	09.2015		CLCA	4	GPE 74
	NEW 2.0 TDI 4motion	1968	81	05.2015		CFHF	4	GPE 74
	NEW 2.0 TDI 4motion	1968	92	05.2015		CUUE/DFSE	4	GPE 74
	NEW 2.0 TDI, 4motion	1968	103	05.2015		CFHC/CLCB	4	GPE 74
	NEW 2.0 TDI	1968	110	05.2015		CUUB/DFSB	4	GPE 74
	NEW 2.0 TDI 4motion	1968	110	11.2015		DFSB	4	GPE 74
CADDY IV Kombi (SAB, SAJ)	NEW 1.6 TDI	1598	55	05.2015		CAYE	4	GPE 74
	NEW 1.6 TDI	1598	75	05.2015		CAYD	4	GPE 74
	NEW 2.0 TDI	1968	55	05.2015		CUUF/DFSF	4	GPE 74
	NEW 2.0 TDI	1968	75	05.2015		CUUD/DFSD	4	GPE 74
	NEW 2.0 TDI, 4motion	1968	81	09.2015		CLCA/CFHF	4	GPE 74
	NEW 2.0 TDI 4motion	1968	92	05.2015		CUUE/DFSE	4	GPE 74
	NEW 2.0 TDI, 4motion	1968	103	05.2015		CFHC/CLCB	4	GPE 74
	NEW 2.0 TDI, 4motion	1968	110	05.2015		CUUB/DFSB	4	GPE 74
	NEW 2.0 TDI 4motion	1968	110	11.2015		DFSB	4	GPE 74
CC (358)	2.0 TDI	1968	100	11.2011		CFFA	4	GPE 74

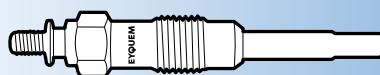



kW



Cyl.



VOLKSWAGEN

	2.0 TDI, 4motion	1968	103	11.2011		CFFB	4	GPE 74
	NEW 2.0 TDI	1968	110	05.2015		CUVC	4	GPE 74
	2.0 TDI	1968	125	11.2011		CFGB/CLLA	4	GPE 74
	2.0 TDI 4motion	1968	125	11.2011		CFGB	4	GPE 74
	2.0 TDI, 4motion	1968	130	12.2012		CFGC	4	GPE 74
	NEW 2.0 TDI	1968	135	05.2015		CUWA	4	GPE 74
CRAFTER 30-35 Bus (2E_)	2.0 TDI	1968	80	05.2011		CKTB	4	GPE 74
	NEW 2.0 TDI	1968	84	11.2013		CSLB	4	GPE 74
	2.0 TDI	1968	100	05.2011		CKTC	4	GPE 74
	2.0 TDI	1968	105	10.2011		CKUC	4	GPE 74
	2.0 TDI, 4motion	1968	120	07.2011		CKUB/CSNA	4	GPE 74
CRAFTER 30-35 Camionnette (2E_)	2.0 TDI	1968	80	05.2011		CKTB	4	GPE 74
	NEW 2.0 TDI	1968	84	11.2013		CSLB	4	GPE 74
	2.0 TDI	1968	100	05.2011		CKTC	4	GPE 74
	NEW 2.0 TDI	1968	103	11.2015		CSLC	4	GPE 74
	2.0 TDI	1968	105	10.2011		CKUC	4	GPE 74
	2.0 TDI, 4motion	1968	120	07.2011		CKUB/CSNA	4	GPE 74
CRAFTER 30-50 Camion/ Plate-forme (2F_)	2.0 TDI	1968	80	05.2011		CKTB	4	GPE 74
	NEW 2.0 TDI	1968	84	11.2013		CSLB	4	GPE 74
	2.0 TDI	1968	100	05.2011		CKTC	4	GPE 74
	NEW 2.0 TDI	1968	103	11.2015		CSLC	4	GPE 74
	2.0 TDI	1968	105	10.2011		CKUC	4	GPE 74
	2.0 TDI, 4motion	1968	120	07.2011		CKUB/CSNA	4	GPE 74
CRAFTER Bus (SY_)	NEW 2.0 TDI	1968	75	10.2016		DAUB	3	GPE 74
	NEW 2.0 TDI	1968	103	09.2016		DAUA	3	GPE 74
	NEW 2.0 TDI	1968	130	09.2016		DAVA	3	GPE 74
CRAFTER Camionnette (SY_)	NEW 2.0 TDI	1968	75	10.2016		DAUB	3	GPE 74
	NEW 2.0 TDI RWD	1968	90	08.2017		DASA	3	GPE 74
	NEW 2.0 TDI	1968	103	09.2016		DAUA	3	GPE 74
	NEW 2.0 TDI 4motion	1968	103	04.2017		DAUA	3	GPE 74
	NEW 2.0 TDI	1968	130	09.2016		DAVA	3	GPE 74
	NEW 2.0 TDI RWD	1968	130	05.2017		DAWA	3	GPE 74
	NEW 2.0 TDI 4motion	1968	130	03.2017		DAVA	3	GPE 74
CRAFTER Camion/ Plate-Forme (SZ_)	NEW 2.0 TDI	1968	75	11.2016		DAUB	3	GPE 74
	NEW 2.0 TDI RWD	1968	90	08.2017		DASA	3	GPE 74
	NEW 2.0 TDI	1968	103	11.2016		DAUA	3	GPE 74
	NEW 2.0 TDI	1968	130	11.2016		DAVA	3	GPE 74
	NEW 2.0 TDI RWD	1968	130	07.2017		DAWA	3	GPE 74
EOS (1F7, 1F8)	NEW 2.0 TDI	1968	100	11.2010	08.2015	CFFA	4	GPE 74
	2.0 TDI	1968	103	06.2006	05.2008	BMM	4	GPE 70
	2.0 TDI 16V	1968	103	05.2008	08.2015	CFFB/CBAB	4	GPE 74
FOX (5Z1, 5Z3)	1.4 TDI	1422	51	04.2005		BNM	3	G 4
	1.9 D	1896	47	12.2007		ASY	4	G 4
GOLF I (17)	1.5 D	1471	37	08.1976	07.1980	CK	4	G 17
	1.6 D	1588	40	08.1980	07.1983	JK/CR	4	G 17
	1.6 TD	1588	51	03.1982	07.1983	CY	4	G 17
	1.6 TD	1588	55	08.1983	07.1985		4	G 17
GOLF II (19E, 1G1)	1.6 D	1588	37	08.1983	10.1991		4	G 17
	1.6 D	1588	40	08.1983	10.1991	ME/JP	4	G 17
	1.6 TD	1589	44	08.1989	10.1991	1V	4	G 17
	1.6 TD	1588	51	08.1983	10.1991	JR/MF	4	G 17
	1.6 TD	1588	59	04.1989	10.1991	RA/SB	4	G 17
	1.6 TD	1588	55	08.1983	07.1985		4	G 17
GOLF III (1H1)	1.9 SDI	1896	47	07.1995	08.1997	AEY	4	G 37
	1.9 D	1896	48	11.1991	08.1997	1Y	4	G 17
	1.9 TD,GTD	1896	55	11.1991	08.1997	AAZ	4	G 17
	1.9 TDI, Syncro	1896	66	09.1993	08.1997	ALE/1Z/AHU	4	G 37
	1.9 TDI, Syncro	1896	66	09.1993	08.1997	ALE/1Z/AHU (auxiliary heating)	4	G 17
	1.9 TDI	1896	81	04.1996	08.1997	AFN	4	G 17
	1.9 TDI	1896	66	09.1993	08.1997	ALE/1Z/AHU	4	G 37
	1.9 TDI	1896	81	04.1996	08.1997	AFN	4	G 37
	1.9 TDI Syncro (1HX1)	1896	66	08.1995	08.1997	ALE/1Z/AHU	4	G 17
	1.9 TDI Syncro (1HX1)	1896	66	08.1995	08.1997	ALE/1Z/AHU	4	G 37



**kw****Cyl.****VOLKSWAGEN**

GOLF III Cabriolet (1E7)	1.9 TDI	1896	66	08.1995	05.1998	ALE/1Z/AHU	4	G 37	
	1.9 TDI	1896	66	08.1995	05.1998	ALE/1Z/AHU (auxiliary heating)	4	G 17	
	1.9 TDI	1896	81	07.1996	05.1998	AFN	4	G 37	
	1.9 TDI	1896	81	07.1996	05.1998	AFN (auxiliary heating)	4	G 17	
GOLF III Variant (1H5)	1.9 SDI	1896	47	07.1995	04.1999	AEY	4	G 37	
	1.9 SDI	1896	47	07.1995	04.1999	AEY (auxiliary heating)	4	G 37	
	1.9 D	1896	48	07.1993	04.1999	1Y	4	G 17	
	1.9 TD	1896	55	07.1993	04.1999	AAZ	4	G 17	
	1.9 TDI, Syncro	1896	66	03.1994	04.1999	ALE/1Z/AHU	4	G 37	
	1.9 TDI, Syncro	1896	66	03.1994	04.1999	ALE/1Z/AHU (auxiliary heating)	4	G 17	
	1.9 TDI	1896	81	04.1996	04.1999	AFN	4	G 37	
	1.9 TDI	1896	81	04.1996	04.1999	AFN (auxiliary heating)	4	G 17	
	1.9 TDI	1896	81	04.1996	04.1999	AFN (auxiliary heating)	4	G 17	
GOLF IV (1J1)	1.9 SDI	1896	50	08.1997	06.2005	AGP/AQM	4	G 37	
	1.9 TD	1896	55	10.1997	09.1999	AAZ	4	G 17	
	1.9 TDI	1896	66	10.1997	05.2004	AGR/ALH	4	G 37	
	1.9 TDI	1896	66	10.1997	05.2004	AGR/ALH (auxiliary heating)	4	G 17	
	1.9 TDI 4motion	1896	66	07.1998	04.2002	AGR	4	G 37	
	1.9 TDI 4motion	1896	66	07.1998	04.2002	AGR (auxiliary heating)	4	G 17	
	1.9 TDI, 4motion	1896	74	09.2000	10.2001	AXR/ATD	4	G 37	
	1.9 TDI, 4motion	1896	74	11.2001	06.2005	AXR/ATD	4	G 4	
	1.9 TDI	1896	81	08.1997	05.2004	AHF/ASV	4	G 37	
	1.9 TDI	1896	81	08.1997	05.2004	AHF/ASV (auxiliary heating)	4	G 17	
	1.9 TDI	1896	85	12.1998	06.2001	AJM/AUY	4	G 37	
	1.9 TDI 4motion	1896	85	09.1999	06.2001	AJM/AUY	4	G 37	
	1.9 TDI, 4motion	1896	96	11.2000	10.2001	ASZ	4	G 37	
	1.9 TDI, 4motion	1896	96	11.2001	06.2005	ASZ	4	G 4	
	1.9 TDI, 4motion	1896	96	11.2001	06.2005	ASZ (auxiliary heating)	4	G 17	
	1.9 TDI, 4motion	1896	110	05.2000	10.2001	ARL	4	G 37	
	1.9 TDI, 4motion	1896	110	11.2001	06.2005	ARL	4	G 4	
	GOLF IV Cabriolet (1E7)	1.9 TDI	1896	66	06.1998	06.2002	ALE/AHU	4	G 37
		1.9 TDI	1896	66	06.1998	06.2002	ALE/AHU (auxiliary heating)	4	G 17
		1.9 TDI	1896	81	06.1998	06.2002	AVG/AFN	4	G 37
1.9 TDI		1896	81	06.1998	06.2002	AVG/AFN (auxiliary heating)	4	G 17	
1.9 TDI		1896	81	06.1998	06.2002	AVG/AFN (auxiliary heating)	4	G 17	
GOLF IV Variant (1J5)	1.9 SDI	1896	50	05.1999	06.2006	AGP/AQM	4	G 37	
	1.9 TDI	1896	66	05.1999	05.2006	AGR/ALH	4	G 37	
	1.9 TDI	1896	66	05.1999	05.2006	AGR/ALH (auxiliary heating)	4	G 17	
	1.9 TDI 4motion	1896	66	05.1999	04.2002	AGR	4	G 37	
	1.9 TDI 4motion	1896	66	05.1999	04.2002	AGR (auxiliary heating)	4	G 17	
	1.9 TDI, 4motion	1896	74	09.2000	06.2006	ATD	4	G 37	
	1.9 TDI, 4motion	1896	74	09.2000	06.2006	AXR	4	G 4	
	1.9 TDI	1896	81	05.1999	06.2001	AHF/ASV	4	G 37	
	1.9 TDI	1896	81	05.1999	06.2001	AHF/ASV (auxiliary heating)	4	G 17	
	1.9 TDI, 4motion	1896	85	08.1999	06.2001	AJM/AUY	4	G 37	
	1.9 TDI, 4motion	1896	96	11.2000	10.2001	ASZ	4	G 37	
	1.9 TDI, 4motion	1896	96	11.2001	06.2006	ASZ	4	G 4	
	1.9 TDI, 4motion	1896	96	11.2000	06.2006	ASZ (auxiliary heating)	4	G 17	
	1.9 TDI 4motion	1896	110	05.2002	06.2005	ARL	4	G 4	
GOLF PLUS (5M1, 521)	1.6 TDI	1598	66	02.2009	12.2013	CAYB	4	GPE 74	
	1.6 TDI	1598	77	03.2009	12.2013	CAYC	4	GPE 74	
	1.9 TDI	1896	66	05.2005	12.2008	BXF/BXJ/BRU	4	GPE 70	
	1.9 TDI	1896	77	01.2005	01.2009	BXE/BKC/BLS	4	GPE 70	
	2.0 TDI	1968	81	01.2009	12.2013	CBDC/CLCA	4	GPE 74	
	2.0 TDI	1968	96	05.2005	05.2007	BEE	4	GPE 71	
	2.0 TDI	1968	100	05.2005	12.2013	AZV	4	GPE 71	
	2.0 TDI	1968	100	05.2005	12.2013	CBDA/CFHB	4	GPE 74	
	2.0 TDI	1968	103	12.2005	05.2009	BMM	4	GPE 70	
	2.0 TDI 16V	1968	103	01.2005	12.2013	BKD	4	GPE 71	
	2.0 TDI 16V	1968	103	01.2005	12.2013	CBDB/CFHC	4	GPE 74	
	GOLF V (1K1)	1.9 SDI	1896	47	12.2005		BGG	4	G 17
1.9 TDI		1896	66	05.2004	11.2008	BXF/BXJ/BRU	4	GPE 70	
1.9 TDI		1896	77	10.2003	11.2008	BXE/BKC/BLS	4	GPE 70	
1.9 TDI 4motion		1896	77	08.2004	11.2008	BXE/BKC/BLS	4	GPE 70	
2.0 SDI		1968	55	01.2004	11.2008	BDK	4	GPE 70	
2.0 TDI		1968	100	10.2003	11.2008	AZV/CBDA	4	GPE 71	
2.0 TDI		1968	103	12.2004	11.2008	BMM	4	GPE 70	

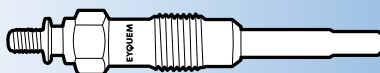



kW



Cyl.



VOLKSWAGEN

	2.0 TDI 4motion	1968	103	08.2004	11.2008	BMM	4	GPE 70
	2.0 TDI 16V	1968	103	10.2003	11.2008	BKD	4	GPE 71
	2.0 TDI 16V 4motion	1968	103	08.2004	11.2008	BKD	4	GPE 71
GOLF V Variant (1K5)	1.9 TDI	1896	77	06.2007	07.2009	BXE/BKC/BLS	4	GPE 70
	1.9 TDI 4motion	1896	77	01.2008	07.2009	BLS	4	GPE 70
	2.0 TDI	1968	100	06.2007	07.2009	AZV	4	GPE 71
	2.0 TDI	1968	103	06.2007	07.2009	BMM	4	GPE 70
	2.0 TDI 16V	1968	103	06.2007	07.2009	BKD	4	GPE 71
	2.0 TDI 16V	1968	103	06.2007	07.2009	CBDB	4	GPE 74
GOLF VI (5K1)	1.6 TDI	1598	66	02.2009	11.2012	CAYB	4	GPE 74
	1.6 TDI	1598	77	02.2009	11.2012	CAYC	4	GPE 74
	2.0 TDI	1968	81	10.2008	11.2012	CBDC/CLCA	4	GPE 74
	2.0 TDI	1968	100	10.2008	11.2012	CBAA/CFFA	4	GPE 74
	2.0 TDI	1968	103	10.2008	05.2013	CFFB/CJAA/CBAB	4	GPE 74
	2.0 TDI 4motion	1968	103	05.2009	11.2012	CFFB/CBAB	4	GPE 74
GOLF VI Cabriolet (517)	2.0 TDI	1968	125	04.2009	11.2012	CFGB/CBBB	4	GPE 74
	1.6 TDI	1598	77	03.2011		CAYC	4	GPE 74
	2.0 TDI	1968	81	11.2013		CUUA	4	GPE 74
	2.0 TDI	1968	103	11.2011		CFHC	4	GPE 74
	2.0 TDI	1968	110	11.2013		CUUB	4	GPE 74
GOLF VI Variant (AJ5)	1.6 TDI	1598	66	12.2009	07.2013	CAYB	4	GPE 74
	1.6 TDI, 4motion	1598	77	07.2009	07.2013	CAYC	4	GPE 74
	2.0 TDI	1968	81	01.2010	07.2013	CLCA	4	GPE 74
	2.0 TDI	1968	103	07.2009		BMM	4	GPE 70
	2.0 TDI 16V	1968	103	07.2009	07.2013	CBDB/CFHC/CLCB	4	GPE 74
GOLF VII (5G1, BE1)	1.6 TDI	1598	66	04.2013		CLHB/CRKA	4	GPE 74
	1.6 TDI	1598	77	08.2012		CLHA	4	GPE 74
	1.6 TDI 4motion	1598	77	11.2012		CLHA	4	GPE 74
	1.6 TDI	1598	81	01.2013		CRKB/CXXB	4	GPE 74
	1.6 TDI 4motion	1598	81	01.2013		CRKB	4	GPE 74
	2.0 TDI	1968	81	11.2012		CRVA	4	GPE 74
	NEW 2.0 TDI	1968	85	04.2016		DDYA	3	GPE 74
	2.0 TDI	1968	105	08.2012		CRBB	4	GPE 74
	2.0 TDI, 4motion	1968	110	11.2012		CRBC/CRLB	4	GPE 74
	2.0 GTD	1968	135	04.2013		CUNA	4	GPE 74
GOLF VII Variant (BA5)	1.6 TDI	1598	66	05.2013		CLHB/CRKA	4	GPE 74
	1.6 TDI, 4motion	1598	77	05.2013		CLHA	4	GPE 74
	1.6 TDI, 4motion	1598	81	05.2013		CRKB/CXXB	4	GPE 74
	2.0 TDI	1968	81	05.2013		CRVA/CYKB/CRLD	4	GPE 74
	NEW 2.0 TDI	1968	85	11.2016		DDYA	3	GPE 74
	2.0 TDI, 4motion	1968	110	04.2013		CRLB/CRBC	4	GPE 74
	2.0 GTD	1968	135	01.2015		CUNA	4	GPE 74
GOLF ALLTRACK (BA5)	1.6 TDI	1598	81	12.2014		CRKB/CXXB	4	GPE 74
	2.0 TDI 4motion	1968	110	12.2014		CRLB/CRBC	4	GPE 74
	NEW 2.0 TDI 4motion	1968	135	12.2014		CUNA/DGCA	3	GPE 74
GOLF SPORTSVAN (AM1)	1.6 TDI	1598	66	02.2014		CRKA/CXXA	4	GPE 74
	1.6 TDI	1598	81	02.2014		CRKB/CXXB	4	GPE 74
	2.0 TDI	1968	81	05.2014		CRVA	4	GPE 74
	NEW 2.0 TDI	1968	85	11.2016		DDYA	3	GPE 74
	2.0 TDI	1968	110	02.2014		CRLB	4	GPE 74
ILTIS (183)	1.6 TD	1588	51	08.1987	12.1988	1C	4	G 17
JETTA I (16)	1.5 D	1471	37	08.1978	07.1980	CK	4	G 17
	1.6 D	1588	40	08.1980	02.1984	JK/CR	4	G 17
	1.6 TD	1588	51	03.1982	02.1984	CY	4	G 17
JETTA II (19E, 1G2)	1.6 D	1588	40	01.1984	10.1991	ME/JP	4	G 17
	1.6 TD	1589	44	01.1990	10.1991	1V	4	G 17
	1.6 TD	1588	51	01.1984	10.1991	JR/MF	4	G 17
	1.6 TD	1588	59	04.1989	10.1991	RA/SB	4	G 17
JETTA III (1K2)	1.6 TDI	1598	66	12.2009	10.2010	CAYB	4	GPE 74
	1.6 TDI	1598	77	06.2009	10.2010	CAYC	4	GPE 74
	1.9 TDI	1896	77	08.2005	10.2010	BXE/BKC/BLS	4	GPE 70
	2.0 TDI	1968	100	09.2005	10.2010	AZV	4	GPE 71
	2.0 TDI	1968	100	09.2005	10.2010	CBDA	4	GPE 74
	2.0 TDI	1968	103	10.2005	10.2010	BMM	4	GPE 70
	2.0 TDI 16V	1968	103	08.2005	10.2010	BKD	4	GPE 71





kW



Cyl.



VOLKSWAGEN

	2.0 TDI 16V	1968	103	08.2005	10.2010		CBDB	4	GPE 74
	2.0 TDI	1968	125	10.2006	10.2010		CEGA	4	GPE 74
JETTA IV (162, 163)	1.6 TDI	1598	77	02.2011			CAYC	4	GPE 74
	2.0 TDI	1968	81	10.2010			CLCA	4	GPE 74
	2.0 TDI	1968	103	02.2011			CFFB/CFHC/CLCB	4	GPE 74
	2.0 TDI	1968	110	08.2014			CUUB	4	GPE 74
LT 28-35 I Bus (281-363)	2.4 D	2383	51	08.1989	06.1996		1S/ACT	6	G 17
	2.4 D	2383	55	01.1979	07.1992		DW/CP	6	G 17
	2.4 TD	2383	68	08.1989	08.1992		1G	6	G 17
	2.4 TD	2383	70	09.1992	06.1996		ACL	6	G 17
	2.4 TD	2383	75	12.1982	07.1989		DV	6	G 17
LT 28-35 I Camionnette (281-363)	2.4 D	2383	51	07.1990	05.1996		1S/ACT	6	G 17
	2.4 D	2383	55	01.1979	07.1992		DW/CP	6	G 17
	2.4 TD	2383	68	08.1988	08.1992		1G	6	G 17
	2.4 TD	2383	70	06.1992	05.1996		ACL	6	G 17
	2.4 TD	2383	75	02.1986	08.1992		DV	6	G 17
LT 28-35 I Camion/ Plate-forme (281-363)	2.7 D	2710	48	11.1975	01.1980		CG	4	G 17
	2.4 D	2383	51	08.1990	06.1996		1S/ACT	6	G 17
	2.4 D Syncro	2383	51	08.1991	07.1992		1S	6	G 17
	2.4 D	2383	55	12.1978	02.1991		DW/CP	6	G 17
	2.4 D Syncro	2383	55	08.1991	07.1992		DW	6	G 17
	2.4 TD	2383	68	08.1990	08.1992		1G	6	G 17
	2.4 TD	2383	70	08.1992	06.1996		ACL	6	G 17
	2.4 TD	2383	75	12.1982	09.1993		DV	6	G 17
LT 28-35 II Bus (2DB, 2DE, 2DK)	2.7 D	2710	48	11.1975	01.1980		CG	4	G 17
	2.5 SDI	2461	55	07.1996	07.2006		AGX	5	G 37
	2.5 TDI	2461	61	05.2001	07.2006		BBE	5	G 37
	2.5 TDI	2461	66	05.1999	07.2006		APA	5	G 37
	2.5 TDI	2461	70	05.2001	07.2006		BBF	5	G 37
	2.5 TDI	2461	75	05.1996	08.1999		AHD	5	G 37
LT 28-46 II Camionnette (2DA, 2DD, 2DH)	2.5 TDI	2461	80	05.1999	07.2006		AVR/ANJ	5	G 37
	2.5 SDI	2461	55	09.1996	07.2006		AGX	5	G 37
	2.5 TDI	2461	61	05.2001	07.2006		BBE	5	G 37
	2.5 TDI	2461	66	05.1999	07.2006		APA	5	G 37
	2.5 TDI	2461	70	05.2001	07.2006		BBF	5	G 37
	2.5 TDI	2461	75	05.1996	08.1999		AHD	5	G 37
LT 28-46 II Camion/Plate-forme (2DC, 2DF, 2DG, 2DL, 2DM)	2.5 TDI	2461	80	05.1999	07.2006		AVR/ANJ	5	G 37
	2.5 SDI	2461	55	09.1996	07.2006		AGX	5	G 37
	2.5 TDI	2461	61	05.2001	07.2006		BBE	5	G 37
	2.5 TDI	2461	66	05.1999	07.2006		APA	5	G 37
	2.5 TDI	2461	70	05.2001	07.2006		BBF	5	G 37
	2.5 TDI	2461	75	06.1996	08.1999		AHD	5	G 37
LT 40-55 I Camionnette (291-512)	2.5 TDI	2461	80	05.1999	07.2006		AVR/ANJ	5	G 37
	2.4 D	2383	51	07.1990	05.1996		1S/ACT	6	G 17
	2.4 D	2383	55	01.1979	07.1992		DW/CP	6	G 17
	2.4 D 4WD	2383	55	01.1979	03.1986		DW	6	G 17
	2.4 TD	2383	68	08.1988	08.1992		1G	6	G 17
	2.4 TD	2383	70	06.1992	05.1996		ACL	6	G 17
	2.4 TD	2383	75	02.1986	08.1992		DV	6	G 17
	2.4 TD 4WD	2383	75	08.1978	07.1992		DV	6	G 17
LT 40-55 I Camion/Plate-forme (293-909)	2.4 D	2383	51	08.1990	06.1996		1S/ACT	6	G 17
	2.4 D	2383	55	12.1978	02.1991		DW/CP	6	G 17
	2.4 TD	2383	68	08.1988	07.1991		1G	6	G 17
	2.4 TD	2383	70	08.1992	06.1996		ACL	6	G 17
	2.4 TD	2383	75	12.1982	09.1993		DV	6	G 17
LUPO (6X1, 6E1)	1.2 TDI 3L	1191	45	07.1999	07.2005		AYZ	3	G 4
	1.2 TDI 3L	1191	45	07.1999	07.2005		ANY	3	G 37
	1.4 TDI	1422	55	01.1999	10.2001		AMF	3	G 37
	1.4 TDI	1422	55	11.2001	07.2005		AMF	3	G 4
	1.7 SDI	1716	44	09.1998	07.2005		AKU	4	G 37





kW



Cyl.

**VOLKSWAGEN**

MULTIVAN V (7HM, 7HN, 7HF, 7EF, 7EM, 7EN)	1.9 TDI	1896	62	01.2006	11.2009	BRR	4	GPE 70
	1.9 TDI	1896	63	04.2003	11.2009	AXC	4	G 4
	1.9 TDI	1896	75	06.2006	11.2009	BRS	4	GPE 70
	1.9 TDI	1896	77	04.2003	11.2009	AXB	4	G 4
	2.0 TDI	1968	62	09.2009		CAAA	4	GPE 74
	2.0 TDI	1968	75	09.2009		CAAB	4	GPE 74
	2.0 TDI	1968	84	05.2011		CAAD	4	GPE 74
	2.0 TDI, 4motion	1968	100	05.2010		CAAE/CCHB	4	GPE 74
	2.0 TDI, 4motion	1968	103	09.2009		CAAC/CCHA	4	GPE 74
	2.0 BITDI, 4motion	1968	132	09.2009		CFCA	4	GPE 74
	2.5 TDI, 4motion	2461	96	04.2003	11.2009	AXD	5	G 4
	2.5 TDI	2461	120	11.2003	11.2009	BLJ	5	G 4
	2.5 TDI, 4motion	2461	128	04.2003	11.2009	AXE	5	G 4
MULTIVAN VI (SGF, SGM, SGN)	NEW 2.0 TDI	1968	62	04.2015		CXGA	3	GPE 74
	NEW 2.0 TDI	1968	75	04.2015		CAAB	4	GPE 74
	NEW 2.0 TDI	1968	75	04.2015		CXGB	3	GPE 74
	NEW 2.0 TDI	1968	84	05.2016		CXHB	3	GPE 74
	NEW 2.0 TDI, 4motion	1968	103	04.2015		CAAC	4	GPE 74
	NEW 2.0 TDI, 4motion	1968	110	04.2015		CXFA/CXHA	3	GPE 74
	NEW 2.0 TDI, 4motion	1968	132	04.2015		CFCA	4	GPE 74
	NEW 2.0 TDI, 4motion	1968	150	06.2015		CXEB	3	GPE 74
NEW BEETLE (9C1, 1C1)	1.9 TDI	1896	66	01.1998	06.2004	ALH	4	G 37
	1.9 TDI	1896	66	01.1998	06.2004	ALH (auxiliary heating)	4	G 17
	1.9 TDI	1896	74	02.2001	09.2010	ATD	4	G 4
	1.9 TDI	1896	77	07.2005	09.2010	BSW	4	G 4
NEW BEETLE Cabriolet (1Y7)	1.9 TDI	1896	74	06.2003	09.2010	AXR	4	G 4
	1.9 TDI	1896	77	07.2005	09.2010	BSW	4	G 4
PARATI	1.9 D	1896	47	08.2002		1Y	4	G 17
	1.9 SDI	1896	47	08.2002		BGG	4	G 17
PASSAT (32)	1.5 D	1471	37	08.1977	07.1980	CK	4	G 17
PASSAT (32B)	1.6 D	1588	40	08.1980	03.1988	JK/CR	4	G 17
	1.6 TD	1588	51	04.1982	03.1988	CY	4	G 17
	1.6 TD	1588	59	05.1986	03.1988	RA	4	G 17
PASSAT (3A2, 35I)	1.6 TD	1588	59	08.1988	09.1993	RA/SB	4	G 17
	1.9 D	1896	50	05.1989	10.1993	1Y	4	G 17
	1.9 TD	1896	55	03.1991	08.1996	AAZ	4	G 17
	1.9 TDI	1896	66	10.1993	08.1996	1Z/AHU	4	G 37
	1.9 TDI	1896	81	03.1996	08.1996	AFN	4	G 37
PASSAT (3B2)	1.9 TDI	1896	66	10.1996	11.2000	AHU/AHH	4	G 37
	1.9 TDI	1896	74	02.2000	11.2000	AVB	4	G 37
	1.9 TDI	1896	74	02.2000	11.2000	AVB	4	G 4
	1.9 TDI, Syncro/4motion	1896	81	10.1996	11.2000	AVG/AFN	4	G 37
	1.9 TDI, 4motion	1896	85	08.1998	11.2000	ATJ/AJM	4	G 37
	1.9 TDI, 4motion	1896	85	08.1998	11.2000	ATJ/AJM (auxiliary heating)	4	G 17
	2.5 TDI	2496	110	07.1998	11.2000	AKN/AFB	6	G 20
	2.5 TDI Syncro/4motion	2496	110	12.1998	11.2000	AKN/AFB	6	G 20
PASSAT (3B3)	1.9 TDI	1896	74	11.2001	10.2001	AVB	4	G 37
	1.9 TDI	1896	74	11.2001	05.2005	AVB	4	G 4
	1.9 TDI, 4motion	1896	96	11.2000	10.2001	AWX/AVF	4	G 37
	1.9 TDI, 4motion	1896	96	11.2001	05.2005	AWX/AVF	4	G 4
	1.9 TDI, 4motion	1896	96	11.2000	10.2001	AWX/AVF (auxiliary heating)	4	G 17
	2.5 TDI, 4motion	2496	110	11.2000	05.2005	AKN/AFB	6	G 20
	2.5 TDI	2496	120	05.2003	05.2005	BDG	6	G 20
	2.5 TDI 4motion	2496	132	01.2003	05.2005	BAU/BDH	6	G 20
PASSAT (3C2)	1.6 TDI	1598	77	08.2009	07.2010	CAYC	4	GPE 74
	1.9 TDI	1896	77	03.2005	11.2008	BXE/BKC/BLS	4	GPE 70
	2.0 TDI	1968	81	11.2008	07.2010	CBDC	4	GPE 74
	2.0 TDI	1968	100	06.007	11.2010	BMA	4	GPE 71
	2.0 TDI	1968	100	03.2005	11.2010	CBAA	4	GPE 74
	2.0 TDI 16V	1968	103	06.2007	05.2009	BKP	4	GPE 71
	2.0 TDI 16V	1968	103	03.2005	07.2010	CBAB	4	GPE 74
	2.0 TDI 16V 4motion	1968	103	03.2005	05.2009	BKP	4	GPE 71
	2.0 TDI 16V 4motion	1968	103	03.2005	07.2010	CBAB	4	GPE 74
	2.0 BlueTDI	1968	105	01.2009	11.2010	CBAC	4	GPE 74

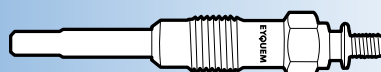



kW



Cyl.



VOLKSWAGEN

		2.0 TDI	1968	125	08.2005	07.2010		CBBB	4	GPE 74
		2.0 TDI 4motion	1968	125	05.2009	07.2010		CBBB	4	GPE 74
PASSAT (362)		1.6 TDI	1598	77	08.2010	12.2014		CAYC	4	GPE 74
		2.0 TDI	1968	100	08.2010	12.2014		CFFA	4	GPE 74
		2.0 TDI, 4motion	1968	103	08.2010	12.2014		CFFB	4	GPE 74
		2.0 TDI, 4motion	1968	125	08.2010	12.2014		CFGB/CLLA	4	GPE 74
		2.0 TDI	1968	130	12.2012	12.2014		CFGC	4	GPE 74
		2.0 TDI 4motion	1968	130	01.2013	12.2014		CFGC	4	GPE 74
PASSAT (3G2)	NEW	1.6 TDI	1598	88	08.2014			DCXA/DCZA	4	GPE 74
	NEW	2.0 TDI	1968	110	11.2014			CRLB/CFGA/DBGA	4	GPE 74
	NEW	2.0 TDI 4motion	1968	110	02.2015			CRLB/DFEA	4	GPE 74
	NEW	2.0 TDI	1968	135	07.2015			CUPA	4	GPE 74
	NEW	2.0 TDI, 4motion	1968	140	11.2014			DDAA/DFCA	4	GPE 74
	NEW	2.0 TDI 4motion	1968	176	08.2014			CUAA	4	GPE 74
PASSAT ALLTRACK (365)		2.0 TDI, 4motion	1968	103	01.2012	12.2014		CFFB	4	GPE 74
		2.0 TDI 4motion	1968	125	01.2012	12.2014		CFGB	4	GPE 74
		2.0 TDI 4motion	1968	130	01.2013	12.2014		CFGC	4	GPE 74
PASSAT ALLTRACK (3G5)	NEW	2.0 TDI 4motion	1968	110	05.2015			CRLB/DFEA	4	GPE 74
	NEW	2.0 TDI 4motion	1968	135	07.2015			CUPA	4	GPE 74
	NEW	2.0 TDI 4motion	1968	140	05.2015			DDAA/DFCA	4	GPE 74
	NEW	2.0 TDI 4motion	1968	176	05.2015			CUAA	4	GPE 74
PASSAT CC (357)		2.0 TDI	1968	100	06.2008	05.2011		CBAA/CFFA	4	GPE 74
		2.0 TDI	1968	103	06.2008	01.2012		CFFB/CBAB	4	GPE 74
		2.0 TDI 4motion	1968	103	08.2009	01.2012		CFFB/CBAB	4	GPE 74
		2.0 BlueTDI	1968	105	05.2009	11.2010		CBAC	4	GPE 74
		2.0 TDI	1968	120	05.2008	05.2011		CBBA	4	GPE 74
		2.0 TDI	1968	125	06.2008	01.2012		CFGB/CLLA/CBBB	4	GPE 74
		2.0 TDI 4motion	1968	125	11.2009	01.2012		CFGB/CBBB	4	GPE 74
PASSAT CC (358)		2.0 BlueTDI	1968	100	11.2011			CFFA	4	GPE 74
		2.0 BlueTDI	1968	103	11.2011			CFFB	4	GPE 74
		2.0 BlueTDI	1968	125	11.2011			CFGB/CLLA	4	GPE 74
		2.0 BlueTDI	1968	130	12.2012			CFGC	4	GPE 74
PASSAT Tricorps (32B)		1.6 TD	1588	51	01.1985	03.1988		CY	4	G 17
PASSAT Variant (32B)		1.6 D	1588	40	08.1980	03.1988		JK/CR	4	G 17
		1.6 TD	1588	51	04.1982	03.1988		CY	4	G 17
		1.6 TD	1588	59	05.1986	03.1988		RA	4	G 17
PASSAT Variant (33)		1.5 D	1471	37	02.1977	07.1980		CK	4	G 17
		1.6 D	1588	40	02.1979	07.1980		CR	4	G 17
PASSAT Variant (3A5, 351)		1.6 TD	1588	59	08.1988	09.1993		RA/SB	4	G 17
		1.9 D	1896	50	05.1989	10.1993		1Y	4	G 17
		1.9 TD	1896	55	03.1991	05.1997		AAZ	4	G 17
		1.9 TDI	1896	66	04.1988	07.1991		1Z/AHU	4	G 37
		1.9 TDI	1896	81	03.1996	05.1997		AFN	4	G 37
PASSAT Variant (3B5)		1.9 TDI	1896	66	06.1997	11.2000		AHU/AHH	4	G 37
		1.9 TDI	1896	74	02.2000	11.2000		AVB	4	G 37
		1.9 TDI	1896	74	02.2000	11.2000		AVB	4	G 4
		1.9 TDI Syncro/4motion	1896	81	06.1997	11.2000		AVG/AFN	4	G 37
		1.9 TDI, 4motion	1896	85	08.1998	11.2000		ATJ/AJM	4	G 37
		1.9 TDI, 4motion	1896	85	08.1998	11.2000		ATJ/AJM (auxiliary heating)	4	G 17
		2.5 TDI	2496	110	07.1998	11.2000		AKN/AFB	6	G 20
		2.5 TDI Syncro/4motion	2496	110	12.1998	11.2000		AKN/AFB	6	G 20
PASSAT Variant (3B6)		1.9 TDI	1896	74	11.2000	05.2005		AVB	4	G 37
		1.9 TDI	1896	74	11.2000	05.2005		AVB	4	G 4
		1.9 TDI	1896	96	11.2000	10.2001		AWX/AVF	4	G 37
		1.9 TDI	1896	96	11.2001	05.2005		AWX/AVF	4	G 4
		1.9 TDI	1896	96	11.2000	10.2001		AWX/AVF (auxiliary heating)	4	G 17
		1.9 TDI 4motion	1896	96	11.2000	10.2001		AVF	4	G 37
		1.9 TDI 4motion	1896	96	11.2001	05.2005		AVF	4	G 4
		1.9 TDI 4motion	1896	96	11.2000	05.2005		AVF (auxiliary heating)	4	G 17
		2.5 TDI, 4motion	2496	110	11.2000	05.2005		AKN/AFB	6	G 20
		2.5 TDI	2496	120	05.2003	05.2005		BDG	6	G 20
		2.5 TDI 4motion	2496	132	01.2003	05.2005		BAU/BDH	6	G 20
PASSAT Variant (3C5)		1.6 TDI	1598	77	08.2009	11.2010		CAYC	4	GPE 74
		1.9 TDI	1896	77	08.2005	11.2008		BXE/BKC/BLS	4	GPE 70
		2.0 TDI	1968	81	11.2008	11.2010		CBDC	4	GPE 74

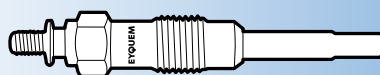



kW

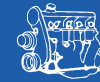

Cyl.



VOLKSWAGEN

	2.0 TDI	1968	100	06.2007	11.2010	BMA	4	GPE 71
	2.0 TDI	1968	100	08.2005	11.2010	CBAA	4	GPE 74
	2.0 TDI 16V	1968	103	06.2007	05.2009	BKP	4	GPE 71
	2.0 TDI 16V	1968	103	08.2005	11.2010	CBAB	4	GPE 74
	2.0 TDI 16V 4motion	1968	103	06.2007	05.2009	BKP	4	GPE 71
	2.0 TDI 16V 4motion	1968	103	08.2005	11.2010	CBAB	4	GPE 74
	2.0 BlueTDI	1968	105	01.2009	11.2010	CBAC	4	GPE 74
	2.0 TDI	1968	125	08.2005	11.2010	CBBB	4	GPE 74
	2.0 TDI 4motion	1968	125	05.2009	11.2010	CBBB	4	GPE 74
PASSAT Variant (365)	1.6 TDI	1598	77	08.2010	12.2014	CAYC	4	GPE 74
	2.0 TDI	1968	100	08.2010	12.2014	CFFA	4	GPE 74
	2.0 TDI	1968	103	08.2010	12.2014	CFFB	4	GPE 74
	2.0 TDI 4motion	1968	103	08.2010	12.2014	CFFB	4	GPE 74
	2.0 TDI	1968	125	08.2010	12.2014	CFGB/CLLA	4	GPE 74
	2.0 TDI 4motion	1968	125	08.2010	01.2013	CFGB	4	GPE 74
	2.0 TDI	1968	130	12.2012	12.2014	CFGC	4	GPE 74
	2.0 TDI 4motion	1968	130	01.2013	12.2014	CFGC	4	GPE 74
PASSAT Variant (3G5)	NEW 1.6 TDI	1598	88	08.2014		DCXA/DCZA	4	GPE 74
	NEW 2.0 TDI	1968	110	11.2014		CRLB/CFGA/DBGA	4	GPE 74
	NEW 2.0 TDI 4motion	1968	110	02.2015		CRLB/DFEA	4	GPE 74
	NEW 2.0 TDI	1968	135	07.2015		CUPA	4	GPE 74
	NEW 2.0 TDI, 4motion	1968	140	11.2014		DDAA/DFCA	4	GPE 74
	NEW 2.0 TDI 4motion	1968	176	08.2014		CJAA	4	GPE 74
PHAETON	3.2 V6	3189	177	04.2002		AYT/BKL	6	GPE 70
	3.2 V6 4motion	3189	177	02.2004		BRK/BKL	6	GPE 70
PHAETON (3D2)	3.0 V6 TDI 4motion	2967	165	09.2004	05.2007	BMK	6	GPE 74
	3.0 V6 TDI 4motion	2967	171	06.2007	11.2008	CARA	6	GPE 74
	3.0 V6 TDI 4motion	2967	176	11.2008	03.2016	CARB/CEXA	6	GPE 74
	3.0 V6 TDI 4motion	2967	180	11.2013	03.2016	CEXB	6	GPE 74
	5.0 V10 TDI 4motion	4921	230	11.2002	10.2006	AJS	10	G 4
POINTER	1.9 SDi	1896	47	12.2005		BGG	4	G 17
	1.9 TD	1896	55	08.1995	09.1997		4	G 17
POLO (6N1)	1.7 SDi	1716	42	04.1997	10.1999	AHG	4	G 37
	1.7 SDi	1716	44	08.1997	10.1999	AKU	4	G 37
	1.9 D	1896	47	10.1994	10.1999	AEF	4	G 17
	1.9 SDi	1896	47	07.1996	10.1999	AGD	4	G 37
POLO (6N2)	1.4 TDI	1422	55	10.1999	09.2001	AMF	3	G 37
	1.7 SDi	1716	44	10.1999	09.2001	AKU	4	G 37
	1.9 D	1896	47	10.1999	09.2001	AEF	4	G 17
	1.9 SDi	1896	47	10.1999	09.2001	ASX/AGD	4	G 37
POLO (6R, 6C)	1.2 TDI	1199	55	10.2009		CFWA	3	GPE 74
	NEW 1.4 TDI	1422	55	03.2014		CUSA/CYZB	3	GPE 74
	NEW 1.4 TDI	1422	66	02.2014		CUSB	3	GPE 74
	NEW 1.4 TDI	1422	77	05.2014		CYZA/CUTA	3	GPE 74
	1.6 TDI	1598	55	06.2009		CAYA	4	GPE 74
	1.6 TDI	1598	66	06.2009		CAYB	4	GPE 74
	1.6 TDI	1598	77	06.2009		CAYC	4	GPE 74
POLO (86C, 80)	1.3 D	1272	33	08.1986	07.1990	MN	4	G 17
	1.4 D	1398	35	10.1990	09.1994	1W	4	G 17
POLO (9N_)	1.4 TDI	1422	51	04.2005	11.2009	BNM/BWB	3	G 4
	1.4 TDI	1422	55	10.2001	06.2005	AMF/BAY	3	G 4
	1.4 TDI	1422	59	04.2005	11.2009	BMS/BNV	3	G 4
	1.9 SDi	1896	47	10.2001	11.2009	ASY	4	G 4
	1.9 TDI	1896	74	10.2001	11.2009	BMT/AXR/ATD	4	G 4
	1.9 TDI	1896	96	11.2003	11.2009	BLT/ASZ	4	G 4
POLO (AW1, BZ1)	NEW 1.6 TDI	1598	59	11.2017		DGTC	3	GPE 74
	NEW 1.6 TDI	1598	70	11.2017		DGTD	3	GPE 74
POLO A (9A4)	1.4 TDI	1422	55	07.2003		BAY	3	G 4
	1.9 SDi	1896	47	09.2002		ASY	4	G 37
POLO CLASSIC (6KV2)	1.7 SDi	1716	42	07.1997	09.2001	AKW	4	G 37
	1.9 SDi	1896	47	12.1995	08.1999	AEY	4	G 37
	1.9 SDi	1896	50	08.1999	09.2001	AGP/AQM	4	G 37
	1.9 TDI	1896	66	09.1996	09.2001	ALE/AHU/AGR/ALH	4	G 37
	1.9 TDI	1896	66	09.1996	09.2001	ALE/AHU/AGR/ALH (auxiliary heating)	4	G 17
	1.9 TDI	1896	81	06.1998	09.2001	AFN/ASV	4	G 37





kW



Cyl.



VOLKSWAGEN

POLO CLASSIC (86C, 80)	1.3 D	1272	33	08.1986	12.1988	MN	4	G 17
	1.4 D	1398	35	10.1990	09.1994	1W	4	G 17
POLO Coupe (86C, 80)	1.3 D	1272	33	08.1986	08.1990	MN	4	G 17
	1.4 D	1398	35	08.1990	09.1994	1W	4	G 17
POLO Camionnette (6NF)	1.7 SDI	1716	44	08.1997	12.1999	AKU	4	G 37
	1.9 D	1896	47	10.1994	12.1999	AEF	4	G 17
	1.9 SDI	1896	47	07.1996	12.1999	AGD	4	G 37
POLO Camionnette (86CF)	1.4 D	1398	35	08.1992	07.1994	1W	4	G 17
POLO Tricorps	1.4 TDI	1422	55	07.2003		BAY	3	G 4
	1.9 SDI	1896	47	09.2002		ASY	4	G 4
	1.9 TDi	1896	74	09.2002		ATD	4	G 4
POLO Variant (6KV5)	1.7 SDI	1716	42	08.1997	09.2001	AKW	4	G 37
	1.9 SDI	1896	47	06.1997	09.2001	AEY	4	G 37
	1.9 SDI	1896	50	08.1999	09.2001	AGP/AQM	4	G 37
	1.9 TDI	1896	66	05.1997	09.2001	ALE/AHU/AGR/ALH	4	G 37
	1.9 TDI	1896	66	05.1997	09.2001	ALE/AHU/AGR/ALH (auxiliary heating)	4	G 17
	1.9 TDI	1896	81	06.1998	09.2001	AFN/ASV	4	G 37
	1.9 TDI	1896	81	06.1998	09.2001	AFN/ASV (auxiliary heating)	4	G 17
QUANTUM	1.9 TD	1896	55	10.1993	06.1997		4	G 17
SANTANA (32B)	1.6 D	1588	40	08.1981	12.1984	JK/CR	4	G 17
	1.6 TD	1588	51	12.1981	12.1984	CY	4	G 17
SAVEIRO Camion/Plate-forme	1.6 D	1588	59	08.1991	07.1996	SB	4	G 17
SCIROCCO (137, 138)	2.0 TDI	1968	100	11.2010		CFHB	4	GPE 74
	2.0 TDI	1968	103	09.2008		CBDB/CFHC	4	GPE 74
	NEW 2.0 TDI	1968	110	11.2013		CUUB	4	GPE 74
	2.0 TDI	1968	125	05.2009		CFGB/CBBB	4	GPE 74
NEW 2.0 TDI	1968	130	01.2013		CFGC	4	GPE 74	
NEW 2.0 TDI	1968	135	05.2014		CUWA-CUXA	4	GPE 74	
SHARAN (7M8, 7M9, 7M6)	1.9 TDI	1896	66	03.2000	03.2010	ANU	4	G 4
	1.9 TDI	1896	66	09.1995	02.2000	ANU/1Z/AHU	4	G 37
	1.9 TDI	1896	66	09.1995	02.2000	ANU/1Z/AHU (auxiliary heating)	3	G 17
	1.9 TDI	1896	81	09.1996	04.2000	AVG/AFN	4	G 37
	1.9 TDI	1896	81	09.1996	04.2000	AVG/AFN (auxiliary heating)	3	G 17
	1.9 TDI	1896	85	04.2000	03.2010	BVK/AUY	4	G 4
	1.9 TDI	1896	85	04.2000	03.2010	BVK/AUY	4	G 37
	1.9 TDI 4motion	1896	85	04.2000	03.2010	BVK/AUY	4	G 4
	1.9 TDI 4motion	1896	85	04.2000	03.2010	BVK/AUY	4	G 37
	1.9 TDI 4motion	1896	85	04.2000	10.2001	BVK/AUY (auxiliary heating)	3	G 17
	1.9 TDI	1896	96	11.2002	03.2010	ASZ	4	G 4
SHARAN (7N1, 7N2)	1.9 TDI	1896	110	06.2005	03.2010	BTB	4	G 4
	2.0 TDI	1968	85	05.2011		CFFE-CUWA-DFLD	4	GPE 74
	2.0 TDI	1968	100	05.2010		CFFA	4	GPE 74
	2.0 TDI 4motion	1968	100	05.2011	05.2012	CFFA	4	GPE 74
	2.0 TDI	1968	103	05.2010		CFFB	4	GPE 74
	2.0 TDI 4motion	1968	103	05.2011		CFFB	4	GPE 74
	NEW 2.0 TDI, 4motion	1968	110	05.2015		CUVC/DFLA	4	GPE 74
	2.0 TDI	1968	125	08.2010		CFGB	4	GPE 74
	2.0 TDI	1968	130	01.2013		CFGC	4	GPE 74
	NEW 2.0 TDI	1968	135	05.2015		CUWA/DFMA	4	GPE 74
NEW 2.0 TDI 4motion	1968	135	05.2016		DFMA	4	GPE 74	
SPACEFOX (5Z6, 5Z7)	1.9 SDI	1896	47	09.2007		ASY	4	G 4
TARO	2.4 D, 4x4	2446	58	07.1994	03.1997	2L	4	G 18
	2.4 D	2446	59	09.1991	07.1994	2L	4	G 18
	2.4 D, 4x4	2446	61	06.1989	03.1997	2L	4	G 18
TIGUAN (5N_)	2.0 TDI	1968	81	05.2010		CFFD	4	GPE 74
	2.0 TDI 4motion	1968	100	11.2007		CBAA/CFFA	4	GPE 74
	2.0 TDI	1968	103	03.2008		CFFB/CBAB	4	GPE 74
	2.0 TDI 4motion	1968	103	09.2007		CFFB/CLJA/CBAB	4	GPE 74
	NEW 2.0 TDI, 4motion	1968	110	05.2015		CUVC	4	GPE 74
	2.0 TDI 4motion	1968	120	02.2008	08.2009	CBBA	4	GPE 74
	2.0 TDI 4motion	1968	125	09.2007		CFGB/CBBB	4	GPE 74
	2.0 TDI 4motion	1968	130	11.2012		CFGC	4	GPE 74
NEW 2.0 TDI 4motion	1968	135	05.2015		CUWA	4	GPE 74	
TIGUAN (AD1)	NEW 1.6 TDI	1598	85	05.2016		DGDB	4	GPE 74
	NEW 2.0 TDI	1968	85	05.2016		DFGC	4	GPE 74





kW



Cyl.



VOLKSWAGEN

	NEW 2.0 TDI, 4motion	1968	110	01.2016		DFGA	4	GPE 74
	NEW 2.0 TDI 4motion	1968	140	04.2016		DFHA	4	GPE 74
	NEW 2.0 TDI 4motion	1968	176	05.2016		CUAA	4	GPE 74
TIGUAN ALLSPACE (BW2)	NEW 2.0 TDI	1968	110	06.2017		DFGA	4	GPE 74
	NEW 2.0 TDI 4motion	1968	110	06.2017		DFGA/DBGCC	4	GPE 74
	NEW 2.0 TDI 4motion	1968	140	06.2017		DFHA	4	GPE 74
	NEW 2.0 TDI 4motion	1968	176	06.2017		CUAA	4	GPE 74
TOUAREG (7LA, 7L6, 7L7)	2.5 R5 TDI	2461	120	08.2003	11.2006	BLK	5	G 4
	2.5 R5 TDI	2461	128	01.2003	05.2010	BAC	5	G 4
	3.0 TDI	2967	155	04.2006	05.2010	CASB/BUN	6	GPE 74
	3.0 V6 TDI	2967	165	11.2004	05.2010	CATA/BKS	6	GPE 74
	3.0 V6 TDI	2967	176	11.2007	05.2010	CASA/CASC	6	GPE 74
	5.0 V10 TDI	4921	230	10.2002	05.2010	AYH	10	G 4
TOUAREG (7P5, 7P6)	3.0 V6 TDI	2967	150	01.2010		CASD/CJMA	6	GPE 74
	3.0 V6 TDI	2967	165	06.2010		CATA	6	GPE 74
	3.0 V6 TDI	2967	176	01.2010		CASA/CNRB	6	GPE 74
	3.0 V6 TDI	2967	180	05.2011		CJGD/CRCA	6	GPE 74
	NEW 3.0 V6 TDI	2967	193	09.2014		CVVA	6	GPE 74
	4.2 V8 TDI	4134	250	01.2010		CKDA	8	GPE 74
TOURAN (1T1, 1T2)	1.9 TDI	1896	66	11.2004	05.2010	BXF/BXJ/BRU	4	GPE 70
	1.9 TDI	1896	74	02.2003	05.2004	AVQ	4	GPE 70
	1.9 TDI	1896	77	08.2003	05.2010	BXE/BKC/BLS	4	GPE 70
	2.0 TDI	1968	100	02.2003	05.2010	AZV	4	GPE 71
	2.0 TDI	1968	103	12.2005	05.2010	BMM	4	GPE 70
	2.0 TDI 16V	1968	103	08.2003	05.2010	CFHC/BKD	4	GPE 71
	2.0 TDI 16V	1968	125	08.2003	05.2010	BMN	4	GPE 74
TOURAN (1T3)	1.6 TDI	1598	66	05.2010	05.2015	CAYB	4	GPE 74
	1.6 TDI	1598	77	05.2010	05.2015	CAYC	4	GPE 74
	2.0 TDI	1968	81	11.2010	05.2015	CLCA	4	GPE 74
	2.0 TDI	1968	103	05.2010	05.2015	CFHC	4	GPE 74
	2.0 TDI	1968	125	05.2010	01.2013	CFJA	4	GPE 74
	2.0 TDI	1968	130	01.2013	05.2015	CFJB	4	GPE 74
TOURAN (5T1)	NEW 1.6 TDI	1598	81	05.2015	05.2016	CRKB	4	GPE 74
	NEW 1.6 TDI	1598	85	05.2016		DGDA	4	GPE 74
	NEW 2.0 TDI	1968	81	11.2015	03.2016	CRVA/CYKB/DFEB/DFGB	4	GPE 74
	NEW 2.0 TDI	1968	110	05.2015	03.2016	DFAA/DFGA	4	GPE 74
	NEW 2.0 TDI	1968	140	11.2015	03.2016	DFHA	4	GPE 74
T-ROC (A11)	NEW 2.0 TDI 4motion	1968	110	09.2017		DFFA	3	GPE 74
TRANSPORTER III Bus	1.6 D	1588	37	01.1981	07.1987	CS	4	G 17
	1.6 TD	1589	51	08.1984	07.1992	JX	4	G 17
	1.6 TD Syncro	1589	51	03.1986	07.1992	JX	4	G 17
	1.7 D	1716	42	10.1986	07.1992	KY	4	G 17
TRANSPORTER III Camionnette	1.6 D	1588	37	01.1981	07.1987	CS	4	G 17
	1.6 TD	1589	51	10.1984	07.1992	JX	4	G 17
	1.6 TD Syncro	1589	51	03.1986	07.1992	JX	4	G 17
	1.7 D	1715	42	08.1985	07.1987	KY	4	G 17
	1.7 D	1716	42	07.1989	07.1992	KY	4	G 17
TRANSPORTER III Camion/ Plate-forme	1.6 D	1588	37	01.1981	07.1987	CS	4	G 17
	1.6 TD	1589	51	10.1984	07.1992	JX	4	G 17
	1.6 TD Syncro	1589	51	03.1986	07.1992	JX	4	G 17
	1.7 D	1716	42	07.1989	07.1992	KY	4	G 17
	1.7 D	1715	42	08.1985	07.1987	KY	4	G 17
TRANSPORTER IV Bus (70XB, 70XC, 7DB, 7DW)	1.9 D	1896	44	09.1990	04.2003	1X	4	G 17
	1.9 D	1896	45	09.1990	12.1995	1X	4	G 17
	1.9 TD	1896	50	10.1992	04.2003	ABL	4	G 17
	2.4 D	2370	55	08.1997	04.2003	AJA	5	G 17
	2.4 D	2370	57	09.1990	04.1998	AAB	5	G 17
	2.4 D Syncro	2370	57	10.1992	09.1998	AAB	5	G 17
	2.5 TDI	2461	65	05.1998	04.2003	AJT/AYY	5	G 37
	2.5 TDI	2461	75	09.1995	04.2003	AYC/AXL/AUF/ACV	5	G 37
	2.5 TDI Syncro	2461	75	01.1996	04.2003	AXL/ACV	5	G 37
	2.5 TDI	2461	111	05.1998	04.2003	AXG/AHY	5	G 37
TRANSPORTER IV Camionnette (70XA)	1.9 D	1896	44	09.1990	12.1995	1X	4	G 17





kW



Cyl.



VOLKSWAGEN

	1.9 D	1896	45	07.1990	04.2003	1X	4	G 17
	1.9 TD	1896	50	10.1992	04.2003	ABL	4	G 17
	2.4 D	2370	55	08.1997	04.2003	AJA	5	G 17
	2.4 D	2370	57	07.1990	04.1998	AAB	5	G 17
	2.4 D Syncro	2370	57	10.1992	09.1998	AAB	5	G 17
	2.5 TDI	2461	65	12.1998	04.2003	AJT/AYY	5	G 37
	2.5 TDI	2461	75	09.1995	04.2003	AYC/AUF/ACV	5	G 37
	2.5 TDI	2461	75	09.1995	04.2003	AYC/AUF/ACV	5	G 37
	2.5 TDI Syncro	2461	75	09.1995	04.2003	AXL/ACV	5	G 37
	2.5 TDI	2461	111	09.2000	04.2003	AXG	5	G 37
TRANSPORTER IV Camion/ Plate-forme (70XD)	1.9 D	1896	44	09.1990	12.1995	1X	4	G 17
	1.9 D	1896	45	07.1990	04.2003	1X	4	G 17
	1.9 TD	1896	50	10.1992	04.2003	ABL	4	G 17
	2.4 D	2370	55	08.1997	04.2003	AJA	5	G 17
	2.4 D	2370	57	09.1990	04.1998	AAB	5	G 17
	2.4 D Syncro	2370	57	10.1992	09.1998	AAB	5	G 17
	2.5 TDI	2461	65	05.1998	04.2003	AJT/AYY	5	G 37
	2.5 TDI	2461	75	09.1995	04.2003	AYC/AUF/ACV	5	G 37
	2.5 TDI Syncro	2461	75	05.1998	04.2003	AXL/ACV	5	G 37
TRANSPORTER V Bus (7HB, 7HJ, 7EB, 7EJ)	1.9 TDI	1896	62	01.2006	11.2009	BRR	4	GPE 70
	1.9 TDI	1896	63	04.2003	11.2009	AXC	4	G 4
	1.9 TDI	1896	75	06.2006	11.2009	BRS	4	GPE 70
	1.9 TDI	1896	77	04.2003	11.2009	AXB	4	G 4
	2.0 TDI	1968	62	09.2009		CAAA	4	GPE 74
	2.0 TDI	1968	75	09.2009		CAAB	4	GPE 74
	2.0 TDI	1968	84	05.2011		CAAD	4	GPE 74
	2.0 TDI, 4motion	1968	100	05.2010		CAAE/CCHB	4	GPE 74
	2.0 TDI, 4motion	1968	103	09.2009		CAAC/CCHA	4	GPE 74
	2.0 BiTDI, 4motion	1968	132	09.2009		CFCA	4	GPE 74
	2.5 TDI	2461	96	04.2003	11.2009	AXD	5	G 4
	2.5 TDI, 4motion	2461	96	07.2004	11.2009	AXD	5	G 4
	2.5 TDi	2461	120	11.2003	11.2009	BLJ	5	G 4
	2.5 TDI, 4motion	2461	128	04.2003	11.2009	AXE	5	G 4
TRANSPORTER V Camionnette (7HA, 7HH, 7EA, 7EH)	1.9 TDI	1896	62	01.2006	11.2009	BRR	4	GPE 70
	1.9 TDI	1896	63	04.2003	11.2009	AXC	4	G 4
	1.9 TDI	1896	75	06.2006	11.2009	BRS	4	GPE 70
	1.9 TDI	1896	77	04.2003	11.2009	AXB	4	G 4
	2.0 TDI	1968	62	09.2009		CAAA	4	GPE 74
	2.0 TDI	1968	75	09.2009		CAAB	4	GPE 74
	2.0 TDI	1968	84	05.2011		CAAD	4	GPE 74
	2.0 TDI, 4motion	1968	100	05.2010		CAAE/CCHB	4	GPE 74
	2.0 TDI, 4motion	1968	103	09.2009		CAAC/CCHA	4	GPE 74
	2.0 BiTDI, 4motion	1968	132	09.2009		CFCA	4	GPE 74
	2.5 TDI, 4motion	2461	96	04.2003	11.2009	AXD	5	G 4
	2.5 TDI, 4motion	2461	128	07.2004	11.2009	AXE	5	G 4
TRANSPORTER V Camion/ Plate-forme (7JD, 7JE, 7JL, 7JY, 7JZ)	1.9 TDI	1896	62	01.2006	11.2009	BRR	4	GPE 70
	1.9 TDI	1896	63	04.2003	11.2009	AXC	4	G 4
	1.9 TDI	1896	75	06.2006	11.2009	BRS	4	GPE 70
	1.9 TDI	1896	77	04.2003	11.2009	AXB	4	G 4
	2.0 TDI	1968	62	09.2009		CAAA	4	GPE 74
	2.0 TDI	1968	75	09.2009		CAAB	4	GPE 74
	2.0 TDI	1968	84	05.2011		CAAD	4	GPE 74
	2.0 TDI, 4motion	1968	100	05.2010		CAAE/CCHB	4	GPE 74
	2.0 TDI, 4motion	1968	103	09.2009		CAAC/CCHA	4	GPE 74
	2.0 BiTDI, 4motion	1968	132	09.2009		CFCA	4	GPE 74
	2.5 TDI, 4motion	2461	96	04.2003	11.2009	AXD	5	G 4
	2.5 TDI, 4motion	2461	128	04.2004	11.2009	AXE	5	G 4
TRANSPORTER VI Bus (SGB, SGG, SGJ)	NEW 2.0 TDI	1968	62	04.2015		CAAA	4	GPE 74
	NEW 2.0 TDI	1968	62	04.2015		CXGA	3	GPE 74
	NEW 2.0 TDI	1968	75	04.2015		CAAB	4	GPE 74

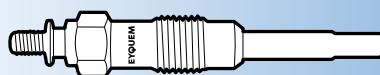



kW



Cyl.



VOLKSWAGEN

	NEW 2.0 TDI	1968	75	04.2015		CXGB	3	GPE 74
	NEW 2.0 TDI	1968	84	05.2016		CXHB	3	GPE 74
	NEW 2.0 TDI, 4motion	1968	103	04.2015		CAAC	4	GPE 74
	NEW 2.0 TDI, 4motion	1968	110	06.2015		CXFA/CXHA	3	GPE 74
	NEW 2.0 TDI, 4motion	1968	132	04.2015		CFCA	4	GPE 74
	NEW 2.0 TDI, 4motion	1968	150	06.2015		CXEB	3	GPE 74
TRANSPORTER VI Camionnette (SGA, SGH)	NEW 2.0 TDI	1968	62	04.2015		CAAA	4	GPE 74
	NEW 2.0 TDI	1968	62	04.2015		CXGA	3	GPE 74
	NEW 2.0 TDI	1968	75	04.2015		CAAB	4	GPE 74
	NEW 2.0 TDI	1968	75	04.2015		CXGB	3	GPE 74
	NEW 2.0 TDI	1968	84	05.2016		CXHB	3	GPE 74
	NEW 2.0 TDI, 4motion	1968	103	04.2015		CAAC	4	GPE 74
	NEW 2.0 TDI, 4motion	1968	110	04.2015		CXFA/CXHA	3	GPE 74
	NEW 2.0 TDI, 4motion	1968	132	04.2015		CFCA	4	GPE 74
	NEW 2.0 TDI, 4motion	1968	150	06.2015		CXEB	3	GPE 74
TRANSPORTER VI Camion/ Plate-forme (SFD, SFE, SFL)	NEW 2.0 TDI	1968	62	04.2015		CAAA/CXGA	4	GPE 74
	NEW 2.0 TDI	1968	75	04.2015		CAAB	4	GPE 74
	NEW 2.0 TDI	1968	75	04.2015		CXGB	3	GPE 74
	NEW 2.0 TDI	1968	84	05.2016		CXHB	3	GPE 74
	NEW 2.0 TDI, 4motion	1968	103	04.2015		CAAC	4	GPE 74
	NEW 2.0 TDI	1968	110	04.2015		CXHA	3	GPE 74
	NEW 2.0 TDI 4motion	1968	110	05.2016		CXHA	3	GPE 74
	NEW 2.0 TDI, 4motion	1968	132	04.2015		CFCA	4	GPE 74
VENTO (1H2)	1.9 SDI	1896	47	04.1997	09.1998	AEY	4	G 37
	1.9 D	1896	48	11.1991	09.1998	1Y	4	G 17
	1.9 TD	1896	55	11.1991	09.1998	AAZ	4	G 17
	1.9 TDI	1896	66	09.1993	09.1998	ALE/1Z/AHU	4	G 37
	1.9 TDI	1896	66	09.1993	09.1998	ALE/1Z/AHU (auxiliary heating)	3	G 17
	1.9 TDI	1896	81	04.1996	09.1998	AFN	4	G 37
	1.9 TDI	1896	81	04.1996	09.1998	AFN (auxiliary heating)	3	G 17
VOYAGE	1.9 TDi	1896	66	09.1999	09.2001	1Z	4	G 37
	1.9 TDi	1896	66	09.1999	09.2001	1Z	4	G 17



CROSS REFERENCES CORRESPONDANCES

UMSCHLÜSSELUNGEN
REFERENCIAS CRUZADAS

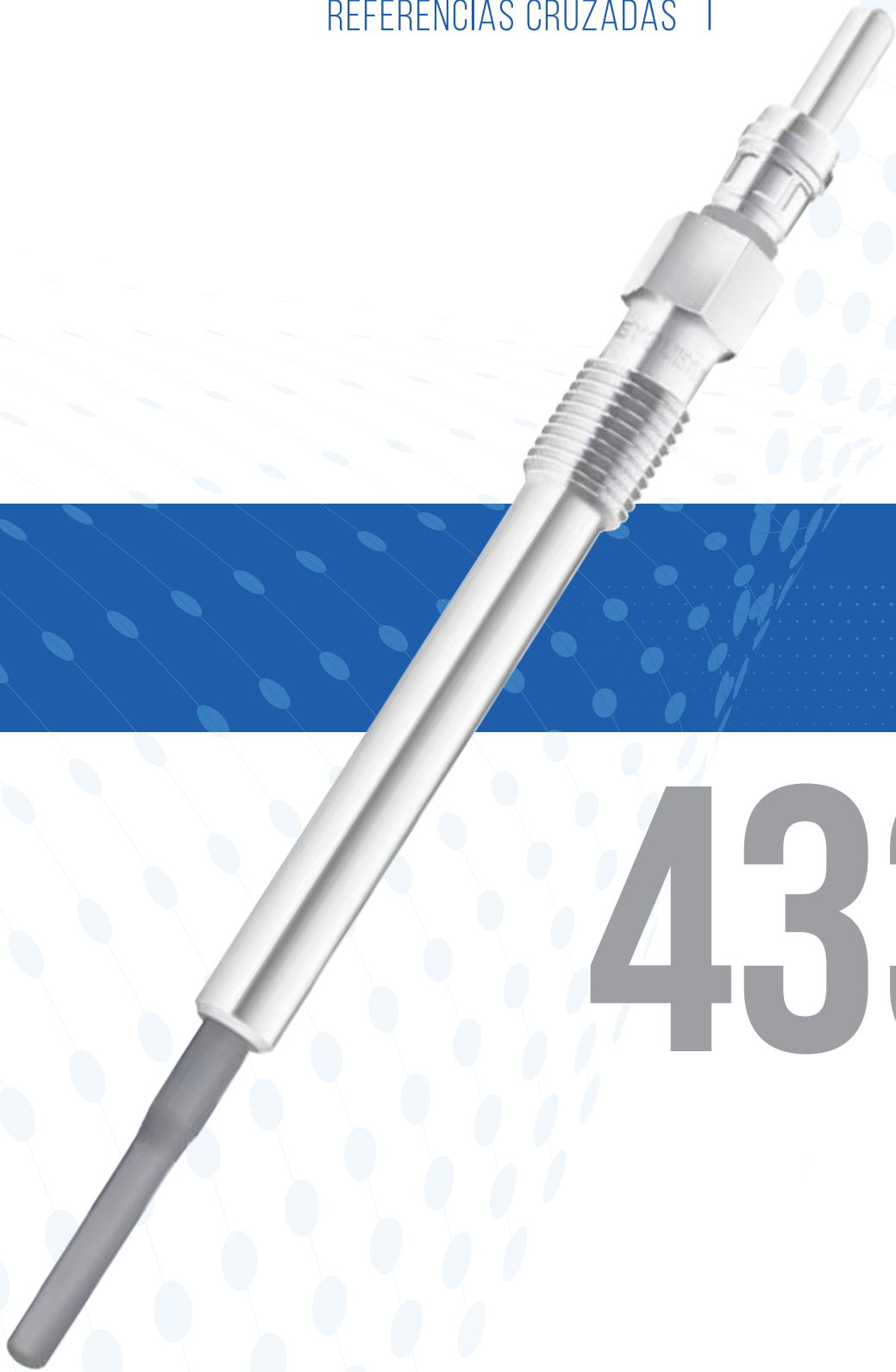

433

EYQUEM

**EYQUEM****AC-DELCO**

103G	G 20
104G	G 21
105G	G 22
106G	G 42
109G	G 23
110G	G 37
114G	G 43
116G	G 41
117G	G 34
118G	G 61
120G	G 41
128G	G 17
138G	G 39
148G	G 24
149G	G 41
230G	G 41
233G	G 45
239G	G 41
240G	G 35
241G	G 41
242G	G 41
243G	G 35
244G	G 41
245G	G 35
246G	G 41
247G	G 27
250G	G 47
28G	G 17
30G	G 41
41G	G 41
48G	G 24
500 GG/93893040	G 17
500 GG/93893040	G 17
503 GG/93893043	G 41
507 GG/93893047	G 41
508 GG/93893048	G 17
508 GG/93893048	G 17
509 GG/93893049	G 2
510 GG/93893050	G 35
511 GG/93893051	G 41
512 GG/93893052	G 41
517 GG/93893057	G 45
518 GG/93893058	G 11
523 GG/93893063	G 12
525 GG/93893065	G 41
526 GG/93893066	G 41
52G	G 12
56G	G 16

ALFA ROMEO

116 61 05 358 00/00	G 2
116 76 05 358 01/00	G 2
464 51 951	G 58
46792355	G 8
55210051	GPE 80
605 07 123	G 2
605 96 245	G 41
606 17 002	G 40
608 16 139	G 58
717 34 087	G 58

AUTOLITE

1101	G 17
1103	G 41
B 17 N	G 17

**EYQUEM****AUTOLITE**

B 19 N	G 41
B 20 N	G 41
B 22 N	G 41
B 23 R	G 41
B 24 SR	G 2
B 25 SR	G 17
B 27 SR	G 35
B 28 SR	G 35
B 29 SR	G 41
B 30 SR	G 41
B 31 SR	G 41
B 32 R	G 41
B 41 SR	G 24
B 42 SR	G 35
B 43 SR	G 17
B 44 SR	G 41
B 48 R	G 27

BERU

0 100 221 106	G 41
0 100 221 107	G 41
0 100 221 132	G 35
0 100 221 133	G 41
0 100 221 135	G 41
0 100 221 141	G 2
0 100 221 144	G 35
0 100 221 145	G 41
0 100 221 146	G 35
0 100 221 147	G 11
0 100 221 154	G 12
0 100 221 163	G 41
0 100 221 167	G 41
0 100 221 168	G 44
0 100 221 170	G 10
0 100 221 186	G 45
0 100 222 101	G 16
0 100 222 106	G 77
0 100 226 129	G 13
0 100 226 163	G 27
0 100 226 170	G 64
0 100 226 173	G 17
0 100 226 180	G 14
0 100 226 184	G 36
0 100 226 185	G 41
0 100 226 186	G 41
0 100 226 188	G 34
0 100 226 189	G 41
0 100 226 194	G 32
0 100 226 198	G 35
0 100 226 206	G 52
0 100 226 207	G 47
0 100 226 208	G 48
0 100 226 209	G 46
0 100 226 227	G 37
0 100 226 229	G 41
0 100 226 233	G 31
0 100 226 234	G 24
0 100 226 235	G 61
0 100 226 237	G 49
0 100 226 238	G 51
0 100 226 243	G 18
0 100 226 245	G 54
0 100 226 246	G 55
0 100 226 249	G 39
0 100 226 250	G 53

**EYQUEM****BERU**

0 100 226 258	G 43
0 100 226 299	G 50
0 100 226 300	G 56
0 100 226 336	G 1
0 100 226 338	G 20
0 100 226 343	G 40
0 100 226 344	G 57
0 100 226 351	G 63
0 100 226 354	G 62
0 100 226 362	G 23
0 100 226 365	G 21
0 100 226 366	G 41
0 100 226 371	G 34
0 100 226 372	G 58
0 100 226 373	G 28
0 100 226 375	G 29
0 100 226 379	G 19
0 100 226 381	G 42
0 100 226 384	G 66
0 100 226 385	G 65
0 100 226 391	G 59
0 100 226 392	G 22
0 100 226 417	G 3
0 100 226 436	G 60
0 100 226 475	G 84
0 100 226 482	G 4
0 100 226 495	G 67
0 100 226 497	G 68
0 100 226 511	G 69
0 100 226 513	G 38
0 100 226 514	G 33
0 100 226 517	G 87
0 100 226 522	G 85
0 100 226 527	G 75
0 100 226 538	G 86
0 100 226 639	G 89
0 100 230 102	G 15
0 100 266 002	GPE 73
0 100 266 008	GPE 70
0 100 266 009	GPE 71
0 100 266 011	GPE 83
0 100 266 031	GPE 80
0 100 266 032	GPE 78
0 100 266 033	GPE 79
0 100 266 034	GPE 82
0 100 266 037	GPE 91
0 100 266 040	GPE 74
0 100 266 050	GPE 90
0 100 266 068	GPE 81
0 100 266 071	GPE 92
0 100 266 075	GPE 93
0 100 266 077	GPE 94
0 100 276 004	G 6
0 100 276 005	G 5
0 100 276 012	G 72
0 100 276 024	G 88
0 100 800 031	G 76
GE 100	GPE 70
GE 101	GPE 71
GE 102	GPE 73
GE 105	GPE 83
GE 110	GPE 78
GE 111	GPE 79
GE 112	GPE 80
GE 114	GPE 82



**EYQUEM****BERU**

GE 115	GPE 74
GE 117	GPE 90
GE 118	GPE 91
GE 121	GPE 81
GE 121A	GPE 81
GE 122	GPE 92
GE 124	GPE 93
GE 126	GPE 94
GE 133	GPE 74
GN 003	G 19
GN 005	G 1
GN 007	G 40
GN 008	G 20
GN 010	G 21
GN 012	G 62
GN 013	G 41
GN 015	G 22
GN 016	G 34
GN 017	G 58
GN 018	G 28
GN 019	G 29
GN 022	G 42
GN 024	G 23
GN 026	G 63
GN 027	G 57
GN 030	G 59
GN 033	G 3
GN 035	G 25
GN 037	G 9
GN 041	G 60
GN 042	G 26
GN 043	G 84
GN 045	G 5
GN 046	G 4
GN 047	G 6
GN 053	G 7
GN 054	G 30
GN 056	G 72
GN 057	G 77
GN 059	G 8
GN 060	G 87
GN 062	G 85
GN 063	G 88
GN 065	G 75
GN 097	G 89
GN 101	G 33
GN 102	G 38
GN 103	G 67
GN 104	G 68
GN 107	G 69
GN 108	G 86
GN 109	G 76
GN 853	G 64
GN 855	G 37
GN 857	G 17
GN 858	G 24
GN 860	G 43
GN 905	G 36
GN 908	G 41
GN 909	G 41
GN 912	G 34
GN 917	G 41
GN 927	G 35
GN 939	G 65
GN 944	G 52

**EYQUEM****BERU**

GN 948	G 61
GN 954	G 41
GN 955	G 31
GN 959	G 49
GN 961	G 53
GN 963	G 54
GN 964	G 55
GN 970	G 39
GN 991	G 50
GN 992	G 56
GN 993	G 66
GN 999	G 51
GV 602	G 41
GV 603	G 41
GV 631	G 35
GV 636	G 41
GV 642	G 41
GV 657	G 2
GV 661	G 35
GV 663	G 41
GV 666	G 35
GV 673	G 11
GV 705	G 12
GV 719	G 41
GV 727	G 41
GV 728	G 44
GV 730	G 10
GV 749	G 45
GV 783	G 13
GV 852	G 27
GV 886	G 14
GV 890	G 15
GV 894	G 16
GV 921	G 32
GV 945	G 46
GV 946	G 47
GV 947	G 48
GV 968	G 18

BMW

12 12 1 286 059	G 41
12 12 1 288 161	G 41
12 12 1 288 245	G 45
12 23 1 288 245	G 41
12 23 2 240 255	G 41
12 23 2 241 387	G 41
12 23 2 241 389	G 41
12 23 2 248 059	G 23
12 23 7 786 869	GPE 73
12 23 7 791 101	G 26
12 23 8 572 135	GPE 91
12 23 9 061 353	G 41
12 23 9 061 354	G 41
77 86 869	GPE 73

BOSCH

0 250 200 053	G 2
0 250 200 054	G 41
0 250 200 056	G 41
0 250 200 057	G 41
0 250 200 058	G 35
0 250 200 059	G 41
0 250 200 060	G 41
0 250 200 061	G 41
0 250 200 065	G 41

**EYQUEM****BOSCH**

0 250 200 066	G 35
0 250 200 068	G 41
0 250 200 069	G 41
0 250 200 454	G 41
0 250 200 456	G 41
0 250 200 465	G 41
0 250 200 468	G 41
0 250 200 469	G 41
0 250 201 001	G 41
0 250 201 004	G 17
0 250 201 005	G 41
0 250 201 006	G 41
0 250 201 008	G 41
0 250 201 009	G 41
0 250 201 011	G 17
0 250 201 012	G 2
0 250 201 017	G 35
0 250 201 019	G 41
0 250 201 026	G 24
0 250 201 027	G 41
0 250 201 029	G 27
0 250 201 030	G 41
0 250 201 032	G 17
0 250 201 033	G 41
0 250 201 034	G 2
0 250 201 035	G 43
0 250 201 037	G 41
0 250 201 038	G 61
0 250 201 039	G 27
0 250 201 040	G 17
0 250 201 041	G 24
0 250 201 042	G 41
0 250 201 043	G 41
0 250 201 045	G 41
0 250 201 046	G 17
0 250 201 047	G 24
0 250 201 048	G 61
0 250 201 049	G 42
0 250 201 050	G 49
0 250 201 053	G 59
0 250 201 054	G 61
0 250 201 055	G 24
0 250 201 405	G 41
0 250 201 927 (SB)	G 41
0 250 201 929 (SB)	G 41
0 250 201 930 (SB)	G 17
0 250 201 932 (SB)	G 41
0 250 201 934 (SB)	G 35
0 250 201 935 (SB)	G 27
0 250 201 936 (SB)	G 41
0 250 201 937 (SB)	G 41
0 250 201 939 (SB)	G 41
0 250 201 940 (SB)	G 24
0 250 202 001	G 35
0 250 202 002	G 10
0 250 202 002	G 62
0 250 202 003	G 11
0 250 202 007	G 12
0 250 202 008	G 45
0 250 202 009	G 37
0 250 202 018	G 35
0 250 202 020	G 34
0 250 202 021	G 50
0 250 202 022	G 37
0 250 202 023	G 40



**EYQUEM****BOSCH**

0 250 202 024	G 50
0 250 202 025	G 36
0 250 202 025	G 51
0 250 202 026	G 53
0 250 202 027	G 52
0 250 202 028	G 58
0 250 202 029	G 19
0 250 202 032	G 57
0 250 202 033	G 35
0 250 202 034	G 39
0 250 202 035	G 54
0 250 202 036	G 60
0 250 202 039	G 19
0 250 202 040	G 13
0 250 202 041	G 21
0 250 202 042	G 56
0 250 202 043	G 3
0 250 202 045	G 19
0 250 202 046	G 4
0 250 202 048	G 30
0 250 202 051	G 14
0 250 202 053	G 18
0 250 202 054	G 16
0 250 202 069	G 15
0 250 202 085	G 47
0 250 202 086	G 46
0 250 202 087	G 48
0 250 202 089	G 1
0 250 202 092	G 69
0 250 202 093	G 64
0 250 202 094	G 11
0 250 202 094	G 31
0 250 202 094	G 32
0 250 202 095	G 84
0 250 202 096	G 18
0 250 202 102	G 20
0 250 202 103	G 23
0 250 202 125	G 75
0 250 202 128	G 63
0 250 202 129	G 29
0 250 202 130	G 65
0 250 202 131	G 66
0 250 202 135	G 30
0 250 202 137	G 68
0 250 202 140	G 53
0 250 202 901 (SB)	G 35
0 250 202 902 (SB)	G 37
0 250 203 001	G 8
0 250 203 002	G 7
0 250 203 004	G 5
0 250 203 009	G 9
0 250 203 012	G 88
0 250 203 018	GPE 92
0 250 204 001	G 6
0 250 204 002	G 72
0 250 212 009	G 28
0 250 251 471	G 39
0 250 312 001	G 33
0 250 312 002	G 38
0 250 312 003	G 67
0 250 312 007	G 69
0 250 402 001	GPE 70
0 250 402 002	GPE 73
0 250 402 005	GPE 70
0 250 403 002	GPE 71

**EYQUEM****BOSCH**

0 250 403 005	GPE 82
0 250 403 006	GPE 83
0 250 403 007	GPE 74
0 250 403 008	GPE 83
0 250 403 009	GPE 74
0 250 403 011	GPE 82
0 250 403 012	GPE 78
0 250 403 013	GPE 79
0 250 403 014	GPE 80
0 250 403 018	GPE 91
0 250 403 020	GPE 90
0 250 403 021	GPE 93
0 250 403 022	GPE 93
0 250 403 023	GPE 94
0 250 404 001	GPE 81
F 005 X04 869	G 38

BOSCH (USA)

80006	G 41
80007	G 41
80008	G 41
80009	G 24
80010	G 17
80011	G 43
80012	G 37
80013	G 61
80015	G 12
80016	G 45
80018	G 14
80019	G 16
80031	G 24

BRISK

21 N 01	G 17
21 N 21	G 41
21 N 22	G 41
21 N 51	G 2
21 R 02	G 35
21 R 06	G 17
21 R 21	G 41
21 R 21	G 41
21 R 21	G 41
21 R 22	G 41
21 R 26	G 27
21 R 51	G 2
21 R 71	G 35
21 R 71	G 35

CHAMPION

CH 110	G 45
CH 132	G 16
CH 137	G 41
CH 137	G 41
CH 147	G 35
CH 147	G 35
CH 154	G 18
CH 155	G 27
CH 156	G 24
CH 157	G 47
CH 158	G 48
CH 159	G 41
CH 160	G 17
CH 162	G 32
CH 163	G 41
CH 163	G 41

**EYQUEM****CHAMPION**

CH 166	G 58
CH 167	G 39
CH 168	G 34
CH 169	G 36
CH 170	G 57
CH 171	G 37
CH 172	G 51
CH 173	G 27
CH 175	G 43
CH 176	G 24
CH 177	G 61
CH 178	G 13
CH 179	G 49
CH 180	G 4
CH 181	G 40
CH 184	G 28
CH 185	G 34
CH 186	G 64
CH 188	G 46
CH 189	G 41
CH 190	G 52
CH 196	G 66
CH 200	G 6
CH 203	G 23
CH 204	G 53
CH 205	G 42
CH 206	G 50
CH 207	G 56
CH 208	G 55
CH 209	G 59
CH 215	G 20
CH 216	G 62
CH 217	G 54
CH 218	G 19
CH 219	G 21
CH 221	G 11
CH 222	G 60
CH 223	G 7
CH 224	G 8
CH 225	G 31
CH 226	G 25
CH 228	G 22
CH 231	G 3
CH 232	G 63
CH 233	G 29
CH 234	G 77
CH 240	G 5
CH 242	G 1
CH 252	G 26
CH 256	G 69
CH 268	G 30
CH 269	G 89
CH 270	G 9
CH 271	G 37
CH 273	G 87
CH 302	G 84
CH 401	G 85
CH 402	G 88
CH 410	G 86
CH 600	G 38
CH 601	G 67
CH 602	G 69
CH 603	G 68
CH 613	G 33
CH 62	G 2



**EYQUEM****CHAMPION**

CH 68	G 41
CH 68	G 41
CH 68	G 41
CH 68	G 41
CH 69	G 17
CH 70	G 2
CH 700	GPE 70
CH 701	GPE 73
CH 702	GPE 71
CH 709	GPE 83
CH 712	GPE 78
CH 713	GPE 79
CH 714	GPE 80
CH 715	GPE 82
CH 716	GPE 90
CH 717	GPE 91
CH 719	GPE 81
CH 722	GPE 93
CH 724	GPE 94
CH 725	GPE 92
CH 79	G 35
CH 87	G 41
CH 88	G 41
CH 88	G 41
CH 90	G 10
CH 94	G 11
CH 95	G 14
CH 97	G 12
CH 97	G 1
X 510	G 41
XCH 512	G 10

CHEVROLET

55 664 219	GPE 80
------------	--------

CITROËN

5960 12	G 6
5960 19	G 6
5960 64	G 30
5960 65	G 30
5960 66	G 57
5960 67	G 57
5960 69	G 34
5960 77	G 5
5960 78	G 72
5960 88	G 65
5960 89	G 65
5960 99	G 88
5960 A0	G 88
5960 A4	G 9
5960 E6	GPE 81
5960 E9	G 6
5960 F4	G 30
5960 F9	G 72
5960 G6	G 88
5960 K6	GPE 81
5960 L4	GPE 80
5962 008	G 41
5962 1P	G 55
5962 1Q	G 55
5962 1R	G 41
5962 1S	G 35
5962 1T	G 41
5962 1V	G 41
5962 1W	G 35

**EYQUEM****CITROËN**

5962 1Y	G 27
5962 1Z	G 17
5962 2Z	G 34
5962 3C	G 57
5962 3E	G 57
5962 3J	G 41
5962 58	G 41
5962 5A	G 62
5962 7F	G 57
5962 7G	G 57
5962 J7	G 17
5962 S8	G 41
5962 T1	G 27
5962 T3	G 45
5962 W2	G 34
5962 W8	G 41
5962 X1	G 41
90 041 002 80	G 35
91 536 646	G 41
91 538 910 99	G 35
95 493 206	G 41
95 534 788	G 41
96 009 783	G 35
96 070 388 80	G 35
96 076 258	G 35
96 141 678	G 41
96 236 383	G 57
96 316 589 80	G 34
96 389 858	G 57
96 756 809 80	GPE 92
96 831 952 80	GPE 81
MKP 000 71	G 17

DAF

105977	G 41
--------	------

DACIA

82 00 682 592	GPE 78
82 00 794 920	GPE 79

DAIHATSU

19850-54050-000	G 16
19850-54090-000	G 18
19850-64010-000	G 14
19850-87701-000	G 14

DENSO

DG-006	G 27
DG-007	G 42
DG-009	G 50
DG-010	G 24
DG-012	G 49
DG-101	G 51
DG-101	G 36
DG-102	G 39
DG-103	G 33
DG-104	G 48
DG-106	G 61
DG-109	G 40
DG-109	G 4
DG-110	G 53
DG-111	G 62
DG-114	G 12
DG-115	G 13
DG-118	G 56

**EYQUEM****DENSO**

DG-119	G 43
DG-124	G 47
DG-126	G 63
DG-127	G 58
DG-129	G 59
DG-133	G 52
DG-137	G 64
DG-140	G 5
DG-142	G 3
DG-143	G 45
DG-144	G 1
DG-145	G 20
DG-146	G 1
DG-155	G 21
DG-159	G 46
DG-170	G 8
DG-171	G 7
DG-172	G 31
DG-173	G 25
DG-174	G 69
DG-177	GPE 70
DG-178	GPE 73
DG-178	GPE 71
DG-180	G 72
DG-181	G 30
DG-184	G 22
DG-188	G 87
DG-193	GPE 74
DG-194	GPE 83
DG-195	G 9
DG-196	G 89
DG-198	G 32
DG-198	G 11
DG-202	G 2
DG-211	G 18
DG-215	G 16
DG-223	G 14
DG-240	G 26
DG-245	G 75
DG-304	G 38
DG-600	G 86
DG-602	G 85
DG-607	GPE 91
DG-608	GPE 82
DG-611	GPE 92
DG-614	G 88
DG-625	GPE 90
DG-631	GPE 93
DG-634	GPE 94

EC - PARTS

EC 4004	G 41
---------	------

EIKO

GF 112	G 11
GI 005	G 45
GM 502	G 12
GN 317	G 15
GT 212	G 14
GT 216	G 16

EUROBCARB

111	G 17
-----	------



**EYQUEM****FEBI - BILSTEIN**

17981	G 51
24094	GPE 73
24176	GPE 70

FIAT

0000071772818	G 89
07029585	G 41
4393814	G 41
4474413	G 41
46447610	G 39
46451951	G 58
46751764	G 59
46754154	G 60
46779614	G 7
46792355	G 8
46796050	G 7
4714294	G 41
4729585	G 41
4754011	G 41
4774412	G 41
4774413	G 41
4781356	G 41
4849406	G 41
500303569	G 62
500316493	G 62
500351992	G 9
5493206	G 41
55187863	G 8
55200755	GPE 82
55200817	G 89
55210051	GPE 80
5950464	G 41
5951861	G 41
5951879	G 41
5951881	G 41
5951882	G 41
5973752	G 41
5973753	G 41
60507123	G 2
60596245	G 41
60617002	G 40
60812292	G 41
60814613	G 58
71734087	G 58
71735462	G 62
71735464	G 59
76226740	G 41
7632587	G 10
7702960	G 41
7735920	G 41
7777837	G 35
9616572480	G 41
9623638380	G 57
9631658980	G 34
9633214380	G 41
9638985980	G 57
9650100080	G 72
9651583680	G 30
98462490	G 41
98498630	G 35
F 2 VB	G 41
F 4 VB	G 41
FU 2 A	G 41
FU 4 A	G 41

**EYQUEM****FORD**

1 008 792	G 42
1 001 049	G 42
1 045 261	G 42
1 056 857	G 42
1 079 401	G 66
1 148 105	G 6
1 207 068	G 4
1 309 471	G 65
1 313 809	G 30
1 427 905	G 88
1 447 128	G 72
1 473 356	G 30
1 525 910	G 6
1 536 023	G 1
1 587 444	G 41
1 682 273	GPE 81
1 682 276	GPE 81
1 690 048	G 40
1 717 631	GPE 92
1 724 842	GPE 80
1C10 6M090AA	G 65
2S6Q 6M090AA	G 6
2S6Q 6M090AB	G 6
2S6Q 6M090BB	G 72
3M 5Q 6M090 AB	G 30
3M 5Q 6M090 AC	G 30
4 612 191	G 65
40 25 139	G 1
4U3Q-6M090 AA	G 5
4U3Q-6M090 AB	G 5
4U3Q-AA	G 5
4U3Q-AB	G 5
5023133	G 12
6 063 505	G 41
6 075 812	G 35
6 132 244	G 35
6 132 246	G 35
6 154 593	G 41
6G9Q 6M090 AA	G 88
7 072 673	G 41
7 088 988	G 35
78 GB 6 M 090 CA	G 41
785 F 6M090 BA	G 41
785 F 6M090 CB	G 41
786 B 6M090 CA	G 41
83 BB 6M090 A1A	G 41
83 BB 6M090 A2A	G 41
84 BB 6M090 AA	G 41
84 FF 6M090 B1A	G 35
84 FF 6M090 B2A	G 35
89 FF 6M090 AA	G 35
910 X 6M090 AA	G 27
910 X 6M090 BA	G 27
910 X 6M090 CA	G 41
910 X 6M090 BA	G 41
93 FF 6M090 AA	G 35
95 DD 6M090 AA	G 40
96 FF 6M090 AA	G 42
96 FF 6M090 AB	G 42
96 FF 6M090 BA	G 42
96 FF 6M090 BB	G 42
96 FF 6M090 CA	G 42
99 FF 6M090 AA	G 42
AV6Q6M090 BA	GPE 81
BS 516M 090 AA	GPE 80

**EYQUEM****FORD**

BK3Q 6M090 AB	GPE 92
EZD 22	G 12
EZD 40	G 42
V 94 DX 6M090 AA	G 41
XM 34 12A342 BA	G 1
XS 4U 6M090 AB	G 66
XS 7U 6M090 BA	G 65
XS 7U 6M090 BB	G 65

GENERAL MOTORS

55 564 162	GPE 82
55 564 219	GPE 80
55 567 737	GPE 90
55 570 037	GPE 94
93 190 433	G 89
93 191 771	GPE 82
95 514 173	GPE 93
95 518 024	GPE 93

HBELPARTS

J5713008	G 1
----------	-----

HELLA

8EG 008 497-491	G 19
8EG 008 497-501	G 20
8EG 008 497-511	G 21
8EG 008 497-521	G 62
8EG 008 497-531	G 22
8EG 008 497-541	G 58
8EG 008 497-551	G 28
8EG 008 497-561	G 29
8EG 008 497-571	G 23
8EG 008 497-581	G 59
8EG 008 497-591	G 60
8EG 008 497-601	G 55
8EG 008 497-611	G 66
PO 749	G 19
PO 750	G 20
PO 751	G 21
PO 752	G 62
PO 753	G 22
PO 754	G 58
PO 755	G 28
PO 756	G 29
PO 757	G 23
PO 758	G 59
PO 759	G 60
PO 760	G 55
PO 761	G 66

HERTH U. BUSS

29 200 010	G 17
29 200 011	G 41
29 200 012	G 17
29 200 014	G 41
J 5711016	G 38
J5711026	G 76

HONDA

12291-PLZ-D00	G 68
---------------	------

HYUNDAI

36710-27000	G 25
36710-27010	G 25
36710-42000	G 32



**EYQUEM****HYUNDAI**

36710-42010	G 31
36710-42020	G 32
36710-42021	G 31
36710-42060	G 31
36710-42500	G 69
36710-42510	G 31
36710-2A 100	G 85
36710-4A 000	G 77
36710-4A 100	G 77

INTERMOTOR

80151	G 2
80152	G 17
80155	G 41
80156	G 2
80157	G 39
80158	G 36
80161	G 18
80162	G 15
80000	G 41
80011	G 2
80015	G 41
80020	G 17
80021	G 17
80024	G 37
80026	G 17
80031	G 41
80034	G 41
80036	G 24
80041	G 35
80044	G 35
80050	G 27
80060	G 27
80100	G 11
80122	G 14
80123	G 16
80124	G 45
80130	G 12
80134	G 47
80135	G 46
80136	G 48
80138	G 14
80140	G 41
80142	G 13
80144	G 35

ISHIKAVAJIMA SHIBAUR

18635-6080	G 12
------------	------

ISKRA

11 721 003	G 17
11 721 003	G 17
11 721 004	G 41
11 721 005	G 2
11 721 006	G 35

ISUZU

8-94221-719-3	G 45
5-81410-057-3	G 20
8-94144-412-0	G 47
8-94221-719-3	G 45
8-94241-449-0	G 45
8-94241-449-1	G 45
8-94241-490	G 45
8-94249-692-1	G 45

**EYQUEM****ISUZU**

8-94255-588-0	G 45
8-94319-700-1	G 47
8-94319-700-2	G 47
8-94402-303-1	G 46
8-94439-218-0	G 45
8-94481-972-0	G 48
8-97080-554-0	G 67
8-97210-818-2	G 68
8-97389-905-0	G 68

IVECO

4841294	G 41
4849406	G 41
500316493	G 62
500351992	G 9
7632587	G 10
98459883	G 35
98462490	G 41
98498630	G 35

JAGUAR

02 JD 61164	G 65
02 JD 61604	G 5

JAPCAR

CP 02	G 38
-------	------

JEEP

0517 5756 AA	GPE 83
--------------	--------

KHD

472 9585	G 41
478 1356	G 41

KIA

36710-42000	G 31
36710-42010	G 31
36710-42020	G 31
36710-42021	G 31
36710-42060	G 31
36710-42500	G 69
36710-2A 100	G 85
36710-4A 000	G 77
36710-4A 100	G 77
OK 054 18 140	G 1
OK 710 18 140	G 1
OK 710 18 140 A	G 1
OK 71E-18-140 A	G 1
OK 75A-18-140	G 1
OK 75B-18-140	G 1

KITAHARA

B 033	G 41
B 040	G 41
B 041	G 41
B 042	G 41
B 043	G 17
B 044	G 41
B 045	G 41
B 046	G 17
B 048	G 2
B 049	G 2
B 052	G 41
B 053	G 35
JKC 7 M JNC	G 46

**EYQUEM****KITAHARA**

JKC 8 DQ 1	G 45
PI 46	G 45
PI 51	G 46
PI 55	G 45
PI 57	G 48
PI 58	G 47
PM 75	G 11
PN 124	G 15
PN 85	G 27
PT 107	G 14
PT 140	G 16
PT 147	G 14
PT 151	G 18
PZ 33	G 12

LANCIA

46 447 610	G 39
46451951	G 58
55210051	GPE 80
60 812 292	G 41
606 17 01	G 40
7632587	G 10
96 236 383 80	G 57

LAND ROVER

LR 001 302	G 88
LR 029 960	GPE 92

LODGE

DR 2	G 41
------	------

LUCAS

6415-3	G 17
6415-4	G 41
DS 001	G 41
DS 002	G 17
DS 003	G 41
DS 003	G 41
DS 006	G 41
DS 017	G 11
DS 018	G 14
DS 020	G 16
DS 025	G 15
DS 026	G 12
DS 032	G 45
DS 040	G 41
DS 052	G 2
DS 056	G 35
DS 058	G 35
DS 122	G 41
DS 850	G 35
HDS 216	G 41
HDS 217	G 17
HDS 218	G 41
HDS 221	G 41
HDS 232	G 11
HDS 233	G 14
HDS 235	G 16
HDS 240	G 15
HDS 241	G 12
HDS 247	G 45
HDS 255	G 41
HDS 266	G 2
HDS 267	G 2
HDS 271	G 35



**EYQUEM****LUCAS**

HDS 273	G 35
HDS 274	G 41
HDS 295	G 41
HDS 297	G 24
HDS 299	G 41
HDS 302	G 45
HDS 303	G 13
HDS 337	G 41
HDS 338	G 46
HDS 339	G 35
HDS 342	G 37
HDS 343	G 17
HDS 346	G 48
HDS 347	G 27
HDS 348	G 41
HDS 349	G 41
HDS 350	G 34
HDS 351	G 41
HDS 352	G 24
HDS 353	G 41
HDS 354	G 61
HDS 355	G 36
HDS 356	G 39
HDS 357	G 10
HDS 359	G 64
HDS 360	G 56
HDS 361	G 40
HDS 362	G 42
HDS 363	G 43
HDS 364	G 58
HDS 365	G 55
HDS 366	G 50
HDS 367	G 57
HDS 368	G 28
HDS 369	G 34
HDS 370	G 51
HDS 371	G 41
HDS 372	G 23
HDS 373	G 53
HDS 374	G 20
HDS 375	G 62
HDS 376	G 54
HDS 379	G 66
HDS 401	G 38

MAN

000 159 8101	G 41
000 159 8301	G 41

MARELLI

DX 1 A	G 17
DX 1 A	G 17
TIX 1 A	G 17
TIX 1 A	G 17
TIX 2 A	G 41
TIX 4 A	G 41
TIX 6 A	G 41
TIX 7 A	G 2
TLX 2 A	G 41
UC 10 A	G 47
UC 11 A	G 58
UC 12 A	G 57
UC 13 A	G 54
UC 14 A	G 40
UC 15 A	G 34

**EYQUEM****MARELLI**

UC 16 A	G 56
UC 17 A	G 19
UC 18 A	G 21
UC 2 A	G 10
UC 3 A	G 37
UC 4 A	G 39
UC 7 A	G 34
UC 8 A	G 36
UX 1 A	G 17
UX 1 A	G 17
UX 11 A	G 35
UX 12 A	G 35
UX 13 A	G 24
UX 14 A	G 27
UX 15 A	G 41
UX 2 A	G 41
UX 4 A	G 41
UX 7 A	G 2
UX 8 A	G 17

MAZDA

RF 1M-18-601	G 1
RFG 1 18 601	G 1
RFN 1 18 601	G 1
RFN 1 18 601 A	G 1
RFR 1 18 601	G 1
S 201 18140	G 12
S 210 18 140	G 1
S 501 18140	G 12
S 501 18140	G 12
WL 01 18 601	G 1
WL 03 18 601	G 1
WL 81 18 601	G 1
Y 401 18 601	G 6
Y 650 18 601	GPE 81

MERCEDES

000 159 75 01	G 41
000 159 77 01	G 41
000 159 81 01	G 41
000 159 83 01	G 41
001 159 00 01	G 24
001 159 15 01	G 43
001 159 16 01	G 43
001 159 17 01	G 24
001 159 20 01	G 61
001 159 21 01	G 61
001 159 22 01	G 41
001 159 26 01	G 53
001 159 27 01	G 21
001 159 28 01	G 19
001 159 35 01	G 41
001 159 36 01	G 24
001 159 37 01	G 19
001 159 38 01	G 19
001 159 42 01	G 19
001 159 48 01	G 19
001 159 49 01	G 19
001 159 50 01	GPE 83
001 159 71 01	GPE 83
660 159 00 01	G 22
660 159 02 01	G 22
661 159 30 01	G 24
661 159 31 01	G 24
A 001 159 20 01	G 61

**EYQUEM****MERCEDES**

A 001 159 21 01	G 61
A 001 159 26 01	G 53
A 001 159 27 01	G 21
A 001 159 28 01	G 19
A 001 159 37 01	G 19
A 001 159 38 01	G 19
A 001 159 42 01	G 19
A 001 159 48 01	G 19
A 001 159 49 01	G 19
A 001 159 49 01	G 19
A 001 159 50 01	GPE 83
A 001 159 51 01	GPE 83
A 001 159 71 01	GPE 83
A 622 159 00 01	GPE 93
A 660 159 00 01	G 22
A 660 159 02 01	G 22

MINI

12 23 7 798 001	GPE 91
12 23 8 572 135	GPE 91

MITSUBISHI

36710-42500	G 69
M 816 732	G 17
M 883 828	G 28
MD 050 212	G 11
MD 070 194	G 32
MD 077 167	G 32
MD 197 511	G 69
MD 301 950	G 69
MD 344469	G 69
MD 354500	G 69
MN 980234	GPE 71
MQ 901659	G 1
MR 577 131	G 69

MONARK

90 505 052	G 17
90 505 907	G 41
90 505 910	G 17
90 905 063	G 17

MOTORCRAFT

EZD 10	G 17
EZD 11	G 41
EZD 13	G 2
EZD 14	G 41
EZD 15	G 41
EZD 16	G 41
EZD 2	G 41
EZD 22	G 12
EZD 23	G 24
EZD 24	G 45
EZD 27	G 17
EZD 28	G 41
EZD 29	G 27
EZD 30	G 41
EZD 33	G 37
EZD 36	G 40
EZD 37	G 66
EZD 38	G 65
EZD 39	G 42
EZD 40	G 6
EZD 5	G 41
EZD 6	G 35



**EYQUEM****MOTORCRAFT**

EZD 7	G 12
EZD 8	G 35

NGK

1566	G 1
1229	G 12
1749	G 53
2187	G 16
2189	G 11
2431	G 15
2500	G 76
2691	G 23
2696	G 33
3017	G 38
3078	G 21
3319	G 63
3709	G 77
3786	G 20
3852	G 62
4119	G 13
4187	G 20
4275	G 43
4389	G 39
4467	G 48
4479	G 4
4602	G 2
4694	G 58
4818	G 51
4916	G 50
4937	G 32
4966	G 88
5013	G 25
5059	G 59
5207	G 72
5317	G 27
5376	G 18
5390	G 55
5467	G 75
5513	G 26
5568	G 43
5618	G 22
5837	G 46
5849	GPE 74
5906	G 24
5968	GPE 73
6092	G 8
6140	G 64
6157	G 52
6244	G 45
6287	GPE 83
6298	G 3
6639	G 10
6649	G 56
6704	G 36
6848	G 61
6943	G 40
7492	G 14
7560	GPE 70
7768	GPE 71
7782	G 84
7794	G 5
7880	G 47
7947	G 49
7957	G 30
8888	GPE 74

**EYQUEM****NGK**

8904	GPE 81
8944	G 69
91210	GPE 93
91322	G 72
91648	GPE 91
91766	G 63
92083	G 86
93293	G 76
93337	GPE 92
94103	GPE 78
94251	GPE 82
95061	G 87
96062	GPE 79
96187	G 85
96853	G 9
97219	GPE 80
97520	GPE 92
97618	GPE 93
9974	G 32
CY 01	G 33
CY 02	G 38
CY 07	G 69
CY 51	G 33
CY 52	G 38
CY 53/ DP 08	G 67
CY 57	G 32
CY 57	G 69
DP 13	G 69
DP 21	G 69
DP 47	GPE 73
DP 48	GPE 71
DP 49	GPE 74
DP 50	GPE 70
DP 51	GPE 83
DP 58	GPE 81
DP 39	G 1
DP 44	G 75
DP 57	GPE 74
DP 65	G 86
DP 67	G 85
DP 72	GPE 80
DP 77	GPE 78
DP 78	GPE 82
DP 81	G 87
Y 1002 AS	GPE 74
Y 1005 J	G 30
Y 1010 AS	GPE 93
Y 1012 J	G 86
Y 1035 AS	GPE 78
Y 1036 AS	GPE 79
Y 1039 AS	GPE 91
Y 1045 AS	GPE 92
Y 103-1	G 27
Y 104 R	G 45
Y 107 R	G 12
Y 115 T	G 11
Y 115 T-1	G 11
Y 115 T-1	G 31
Y 118 R	G 16
Y 146 R	G 14
Y 162 R-1	G 15
Y 204 TS	G 17
Y 204 V	G 17
Y 206 T	G 41
Y 207 T	G 17

**EYQUEM****NGK**

Y 207 TS	G 17
Y 208 T	G 41
Y 306 R	G 45
Y 307 R	G 46
Y 501 U/ DP 31	G 20
Y 502 R	G 62
Y 503 J/ DP 10	G 34
Y 503 R	G 34
Y 504 J/ DP 24	G 57
Y 504 R	G 57
Y 506 R	G 54
Y 506J/ DP 07	G 54
Y 507 J/ DP 32	G 23
Y 507 R	G 23
Y 508 J	G 77
Y 515 J/ DP 18	G 28
Y 516 J/ DP 12	G 29
Y 517 J	G 63
Y 519 J	G 76
Y 523 J/ DP 37	G 3
Y 524 J/ DP 27	G 66
Y 525 J/ DP 35	G 65
Y 527 J	G 85
Y 531 J	G 75
Y 532 J	G 84
Y 534 J/ DP 36	G 60
Y 536 J	G 87
Y 541 J	G 68
Y 542 J	G 26
Y 543 J	G 22
Y 547 AS	GPE 73
Y 604 J	G 52
Y 607 AS	GPE 70
Y 609 AS	GPE 74
Y 701 J	G 1
Y 701 R	G 1
Y 707 RS	G 32
Y 710 J	G 47
Y 710 R	G 47
Y 711 J/ DP 28	G 48
Y 711 RS	G 48
Y 712 RS	G 64
Y 715 R	G 18
Y 719 RS	G 48
Y 722 JS	G 32
Y 729 U/ DP 34	G 13
Y 730 U/ DP 17	G 36
Y 731 U/ DP 09	G 34
Y 732 U/ DP 04	G 37
Y 733 J	G 69
Y 738 U	G 55
Y 739 R	G 10
Y 740 U/ DP 22	G 51
Y 741 U/ DP 20	G 40
Y 745 U/ DP 11	G 19
Y 746 J/ DP 38	G 21
Y 746 R	G 21
Y 747 U/ DP 26	G 58
Y 748 U/ DP 14	G 56
Y 749 J	G 25
Y 752 M	G 41
Y 8001 AS	GPE 81
Y 8002 AS	GPE 83
Y 8005 J/ DP 64	G 9
Y 9001 AS	GPE 80

**EYQUEM**

**EYQUEM****NGK**

Y 9003 AS	GPE 82
Y 901 R	G 17
Y 902 R	G 41
Y 907 R	G 35
Y 908 R	G 41
Y 909 R	G 2
Y 910 J/ DP 3	G 35
Y 910 R	G 35
Y 911 J/ DP 33	G 35
Y 911 R	G 35
Y 912 M	G 27
Y 913 J/ DP 15	G 27
Y 913 M	G 27
Y 914 U	G 41
Y 916 J/ DP 06	G 24
Y 916 R	G 24
Y 917 U	G 41
Y 918 J/ DP 2	G 17
Y 918 R	G 17
Y 920 R	G 41
Y 922 R	G 41
Y 923 U	G 41
Y 924 J/ DP 01	G 41
Y 924 U	G 41
Y 925 J/ DP 16	G 61
Y 925 R	G 61
Y 927 J/ DP 19	G 50
Y 927 R	G 50
Y 928 U/ DP 29	G 39
Y 929 U/ DP 41	G 53
Y 930 U/ DP 30	G 43
Y 932 R	G 49
Y 933 J/ DP 25	G 49
Y 933 R	G 49
Y 935 U/ DP 23	G 35
Y 937 J/ DP 05	G 42
Y 937 R	G 42
Y 938 R	G 41
Y 939 J	G 59
YE 04	G 6
YE 05	G 72
YE 07	G 8
YE 08	G 88
YE 12	G 5
YE 14	GPE 71

NIPPARTS

J5712000	G 14
----------	------

NIPPONDENSO

067100-1370	G 16
067100-1430	G 14
067100-1530	G 14
067100-1710	G 18

NISSAN

11065 63 G00	G 32
11065-00 Q00	G 28
11065-00 Q0E	GPE 78
11065-00 Q0H	GPE 93
11065-00 Q0L	GPE 93
11065-00 QAA	G 28
11065-00 QAF	G 28
11065-00 QAG	G 28
11065-00Q0A	G 63

**EYQUEM****NISSAN**

11065-43 G01	G 32
11065-57 J00	G 38
11065-5C 900	G 38
11065-9C600	G 64
11065-AD 200	G 76
11065-AD 201	G 76
11065-AD 20A	G 76
11065-BN 701	G 28
11065-D9701	G 44
11065-D9702	G 44
11065-G5501	G 33
11065-HA300	G 1
11065-T8201	G 15
11065-T8203	G 15
11065-Y 9703	G 17

NISSAN/MOTOR- IBERICA

11065-D 9701	G 44
11065-D 9702	G 44
11065-Y 9703	G 17
11065-Y 9703	G 17
758 000 06-0	G 41
758 000 06-0	G 41

OPEL

12 14 018	G 23
12 14 020	G 28
12 14 032	G 7
12 14 033	G 3
12 14 034	G 8
12 14 035	G 68
12 14 040	G 60
12 14 042	G 48
12 14 043	G 67
12 14 045	G 52
12 14 054	G 56
12 14 062	G 68
12 14 063	G 68
12 14 064	G 89
12 14 067	GPE 90
12 14 070	G 7
12 14 071	G 8
12 14 082	G 28
12 14 084	G 56
12 14 085	G 48
12 14 096	G 68
12 14 098	GPE 94
12 14 301	G 68
12 14 304	G 41
12 14 305	G 3
12 14 306	G 41
12 14 307	G 41
12 14 308	G 45
12 14 309	G 46
12 14 310	G 48
12 14 311	G 47
12 14 312	G 47
12 14 315	G 48
12 14 316	G 67
12 14 317	G 41
12 14 319	G 41
12 14 320	G 48
12 14 322	G 52
12 14 324	G 41
12 14 334	GPE 82

**EYQUEM****OPEL**

12 14 427	G 40
12 14 456	G 56
12 14 457	G 56
18 26 357	GPE 80
44 02 724	G 28
44 02 945	G 54
44 03 145	G 35
44 06 338	GPE 93
44 09 469	G 28
44 16 912	G 28
44 23 206	GPE 93
44 30 069	G 63
44 30 920	G 63
45 06 155	G 63
55 187 863	G 8
55 588 475	G 68
56 14 216	G 17
56 14 218	G 41
56 14 219	G 17
56 14 221	G 45
88 900 715	G 19
88 900 716	G 40
88 900 717	G 20
88 900 718	G 21
88 900 719	G 22
88 900 720	G 42
88 900 721	G 23
88 900 722	G 37
88 900 723	G 17
88 900 724	G 43
88 900 725	G 41
88 900 726	G 34
88 900 727	G 61
88 900 728	G 41
88 900 729	G 39
88 900 730	G 41
88 900 731	G 41
88 900 732	G 35
88 900 733	G 41
88 900 734	G 41
88 900 735	G 35
88 900 736	G 41
88 900 737	G 35
88 900 738	G 41
88 900 739	G 45
88 900 740	G 27
88 900 741	G 24
88 900 742	G 41
88 900 743	G 47
90 040 991	G 35
90 051 950	G 41
90 093 897	G 41
90 166 155	G 41
90 210 824	G 41
90 464 737	G 52
90 487 858	G 41
90 510 924	G 41
90 540 864	G 41
90 569 338	G 56
91 10 724	G 28
91 109 45	G 54
91 111 45	G 35
91 153 919	G 40
91 182 01	G 56
91 966 69	G 3



**EYQUEM****OPEL**

93 171 875	G 23
93 178 047	G 7
93 178 411	G 8
93 180 295	G 60
93 183 738	G 48
93 189 648	G 28
93 197 242	G 56
94 319 700	G 47
94 387 612	G 48
94 402 303	G 46
94 422 1719	G 45
94 439 218	G 45
94 481 972	G 48
95 508 201	G 56
95 508 486	G 7
95 508 487	G 8
95 508 494	G 28
95 508 508	G 48
97 464 737	G 3

PERKINS

K 166 AF 01	G 41
-------------	------

PEUGEOT

5960 12	G 6
5960 19	G 6
5960 64	G 30
5960 65	G 30
5960 66	G 57
5960 67	G 57
5960 76	G 5
5960 78	G 72
5960 79	G 72
5960 88	G 65
5960 89	G 65
5960 99	G 88
5960 A0	G 88
5960 A3	G 9
5960 A4	G 9
5960 E9	G 6
5960 E6	GPE 81
5960 F4	G 30
5960 F9	G 72
5960 G6	G 88
5960 K4	G 9
5960 K6	GPE 81
5960 L4	GPE 80
5961 39	G 41
5961 40	G 41
5961 53	G 41
5961 54	G 41
5961 57	G 41
5961 58	G 41
5962 03	G 41
5962 1P	G 55
5962 1Q	G 55
5962 1Z	G 17
5962 2Y	G 34
5962 35	G 41
5962 3C	G 57
5962 3E	G 57
5962 3H	G 41
5962 4Z	G 62
5962 74	G 41
5962 7F	G 57

**EYQUEM****PEUGEOT**

5962 7G	G 57
5962 J2	G 27
5962 J3	G 35
5962 J4	G 41
5962 J5	G 41
5962 J6	G 41
5962 J7	G 17
5962 K5	G 41
5962 R8	G 41
5962 S8	G 41
5962 T1	G 27
5962 T3	G 45
5962 T7	G 35
5962 W3	G 34
7932 567 718	G 41
9150 860 280	G 41
9150 861 080	G 41
9152 184 980	G 41
9153 664 680	G 41
9553 478 8	G 41
96 009 783	G 35
96 236 383	G 57
96 165 724 80	G 41
96 316 58980	G 34
96 332 14380	G 41
96 37 469980	G 6
96 389 858	G 57
96 756 809 80	GPE 92
96 831 952 80	GPE 81
MKP 000 71	G 17

PORSCHE

955 170 320 90	GPE 74
----------------	--------

PSA

96 38 985 980	G 57
---------------	------

QHAZELL

QGP 105	G 17
QGP 106	G 2
QGP 107	G 41
QGP 111	G 41
QGP 112	G 17
QGP 113	G 2
QGP 114	G 35
QGP 115	G 41
QGP 116	G 41
QGP 117	G 11
QGP 118	G 14
QGP 120	G 12
QGP 128	G 16
QGP 133	G 15
QGP 139	G 45
QGP 147	G 35
QGP 148	G 24
QGP 178	G 42
XHP 052	G 46
XHP 053	G 18
XHP 064	G 41
XHP 081	G 37
XHP 106	G 50
XHP 120	G 39
XHP 128	G 52

**EYQUEM****RENAULT**

110650819R	GPE 93
110651492R	GPE 93
110651749R	GPE 93
50 01 001 587	G 41
77 00 100 558	G 54
77 00 100 586	G 51
77 00 100 635	G 29
77 00 103 674	G 63
77 00 105 290	G 50
77 00 111 323	G 28
77 00 111 940	G 29
77 00 662 199	G 41
77 00 673 874	G 41
77 00 701 130	G 41
77 00 715 768	G 41
77 00 733 076	G 41
77 00 734 956	G 27
77 00 741 144	G 41
77 00 855 865	G 27
77 00 856 238	G 27
77 00 858 208	G 36
77 00 860 796	G 36
77 00 861 906	G 51
77 00 867 002	G 50
77 00 867 617	G 49
77 00 874 336	G 50
77 01 029 762	G 41
77 01 035 956	G 41
77 01 039 387	G 41
77 01 040 208	G 35
77 01 069 730	G 28
77 01 349 475	G 41
77 01 349 943	G 27
77 01 414 072	G 41
77 01 414 076	G 41
77 01 414 077	G 17
77 01 414 078	G 35
77 01 414 079	G 41
77 01 414 080	G 41
77 01 414 081	G 35
77 01 414 083	G 35
77 01 414 084	G 2
77 01 414 086	G 41
77 01 414 088	G 17
77 01 414 089	G 35
77 01 414 107	G 24
77 01 414 108	G 41
77 01 414 123	G 41
77 01 414 157	G 24
82 00 012 099	G 63
82 00 423 224	G 54
82 00 423 227	G 54
82 00 434 855	G 28
82 00 445 627	G 63
82 00 464 077	G 28
82 00 490 950	G 28
82 00 517 313	G 63
82 00 682 592	GPE 78
82 00 787 721	G 29
82 00 794 920	GPE 79
86 71 004 016	G 17

ROVER

ERC 8450	G 41
ETC 8847	G 13



**EYQUEM****ROVER**

NCC 100050	G 36
NCC 100120	G 23
NCC 100120 L	G 23

SAAB

93 178 047	GPE 82
93 191 771	GPE 82

SEAT

0003940685	G 41
N 105 792 01	G 4
N 105 792 02	G 4
SE 138919 000 A	G 41
X 0396 550 20	G 41

SSANGYONG

664 159 00 01	G 87
664 159 01 01	G 87
665 159 00 01	G 87
665 159 01 01	G 87
A 664 159 00 01	G 87
A 664 159 01 01	G 87
A 665 159 00 01	G 87
A 665 159 01 01	G 87

SUZUKI

09900 RF 001	G 1
09900 HD I01	G 57
18550-67G11	G 30
18550-78E00	G 1
18550-78E10	G 1
18550-78E11	G 1
18550-79J50	G 89
18550-79J50 000	G 89
18550-79J81	GPE 82
18550-79J81 000	GPE 82
18550-80KAO-000	GPE 79
18550-84A51-000	G 28
18550-DG122-A00	G 89

SWAG

10 91 5960	G 41
10 91 5960	G 41
10 91 5960	G 41
10 91 5960	G 41
10 91 5960	G 41
10 91 5960	G 2
10 91 5960	G 41
10 91 5964	G 43
10 91 5966	G 61
10 91 8404	G 53
10 91 8408	G 21
10 91 8409	G 19
10 91 9223	G 24
20 91 5963	G 41
20 91 9882	G 23
30 91 5956	G 17
30 91 7979	G 28
30 91 7979	G 37
30 91 7979	G 4
30 91 9900	G 20
40 91 7699	G 67
40 91 7788	G 41
40 91 7788	G 56
40 91 8831	G 68

**EYQUEM****SWAG**

40 91 8835	G 48
50 91 5949	G 40
50 91 5953	G 42
50 91 5962	G 41
50 91 5962	G 35
50 91 5962	G 35
50 91 5962	G 35
50 91 5962	G 35
50 91 9447	G 66
55 91 7980	G 49
55 91 7981	G 36
55 91 7981	G 51
55 92 4095	G 5
60 90 1002	G 29
60 91 5965	G 41
60 91 5965	G 27
60 91 9249	G 54
62 91 5967	G 55
62 91 9099	G 34
70 91 5957	G 57
70 91 5959	G 60
81 91 9103	G 18
82 91 9097	G 32
99 30 0004	G 41

TALBOT

91 507 715 80	G 41
91 507 719 80	G 41

TOYOTA

19850-0R010	G 86
19850-0R020	G 86
19850-0W010	G 26
19850-26010	G 86
19850-26020	G 86
19850-26021	G 86
19850-26022	G 86
19850-27010	G 75
198500R022	G 86
19850-54050	G 16
19850-54090	G 18
19850-64010	G 14
19850-64030	G 84
19850-64031	G 84
19850-64031 B	G 84
19850-64050	G 84
SU001-00671	G 6

UNIC-IVECO

004 729 585	G 41
-------------	------

UNIPART

NCC 100058	G 36
------------	------

VALEO

C 100 S	G 41
C 101 S	G 41
C 102 S	G 41
C 103 S	G 2
C 104 S	G 35
C 105 S	G 35
C 106 S	G 41
C 107 S	G 41
C 108 S	G 35
C 109 S	G 10

**EYQUEM****VALEO**

C 110 S	G 41
C 111 R	G 41
C 113 S	G 44
C 115 R	G 46
C 116 S	G 47
C 117 S	G 48
C 124 R	G 45
C 200 S	G 17
C 201 S	G 24
C 202 R	G 27
C 203 R	G 35
C 204 R	G 41
C 205 R	G 37
C 206 R	G 41
C 207 R	G 34
C 208 R	G 41
C 209 S	G 41
C 210 S	G 36

VAUXHALL

900 33357	G 41
900 93897	G 41
902 10824	G 41

VOLKSWAGEN/AUDI

03L 963 319	GPE 74
03L 963 319 A	GPE 74
059 963 319	G 20
059 963 319 A	G 20
059 963 319 C	GPE 74
059 963 319 E	GPE 74
059 963 319 F	GPE 74
059 963 319 H	G 20
059 963 319 J	GPE 74
068 905 061	G 17
N 019 081 1	G 17
N 019 081 2	G 17
N 019 081 4	G 17
N 019 097 1	G 17
N 019 100 2	G 17
N 019 100 5	G 17
N 019 100 6	G 17
N 101 401 01	G 37
N 101 401 02	G 37
N 101 401 03	G 37
N 101 401 04	G 37
N 101 401 05	G 37
N 102 130 01	G 17
N 102 130 02	G 17
N 105 792 01	G 4
N 105 792 02	G 4
N 105 798 02	GPE 71
N 105 916 02	GPE 70
N 105 916 03	GPE 70

VOLVO

1257141	G 17
1257889	G 17
1542319	G 2
1542411	G 2
30 72 506 9	G 30
30862690	G 51
31216248	G 72
3121624-8	G 6
840643	G 41



**EYQUEM****VOLVO**

8631607	G 5
8653 698	G 30

WELLMANN

W 524	G 35
W 525	G 34
W 527	G 48
W 529	G 46
W 530	G 11
W 531	G 14
W 532	G 12
W 539	G 27
W 541	G 45
W 542	G 13
W 549	G 15
W 558	G 16
W 561	G 35
W 563	G 18
W 566	G 37
W 573	G 51
W 575	G 57
W 576	G 56
W 578	G 36
W 580	G 66
W 581	G 52
W 582	G 39
W 588	G 50
W 590	G 40
W 595	G 55
W 601	G 17
W 602	G 2
W 603	G 41
W 607	G 41
W 608	G 17
W 609	G 2
W 610	G 35
W 613	G 41
W 622	G 24
W 626	G 24
W 630	G 41
W 631	G 41
W 632	G 17
W 633	G 2
W 634	G 27
W 635	G 42
W 640	G 61
W 641	G 43

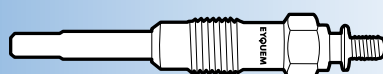
**EYQUEM****EYQUEM**

Technical characteristics / Caractéristiques techniques

Technische Informationen / Características técnicas / caratteristiche tecniche / Características técnicas / informacije tehniczne / Τεχνικά Χαρακτηριστικά / Technické vlastnosti / Teknik Özellikler / Tehnički podatci / Технические характеристики / Технические особенности

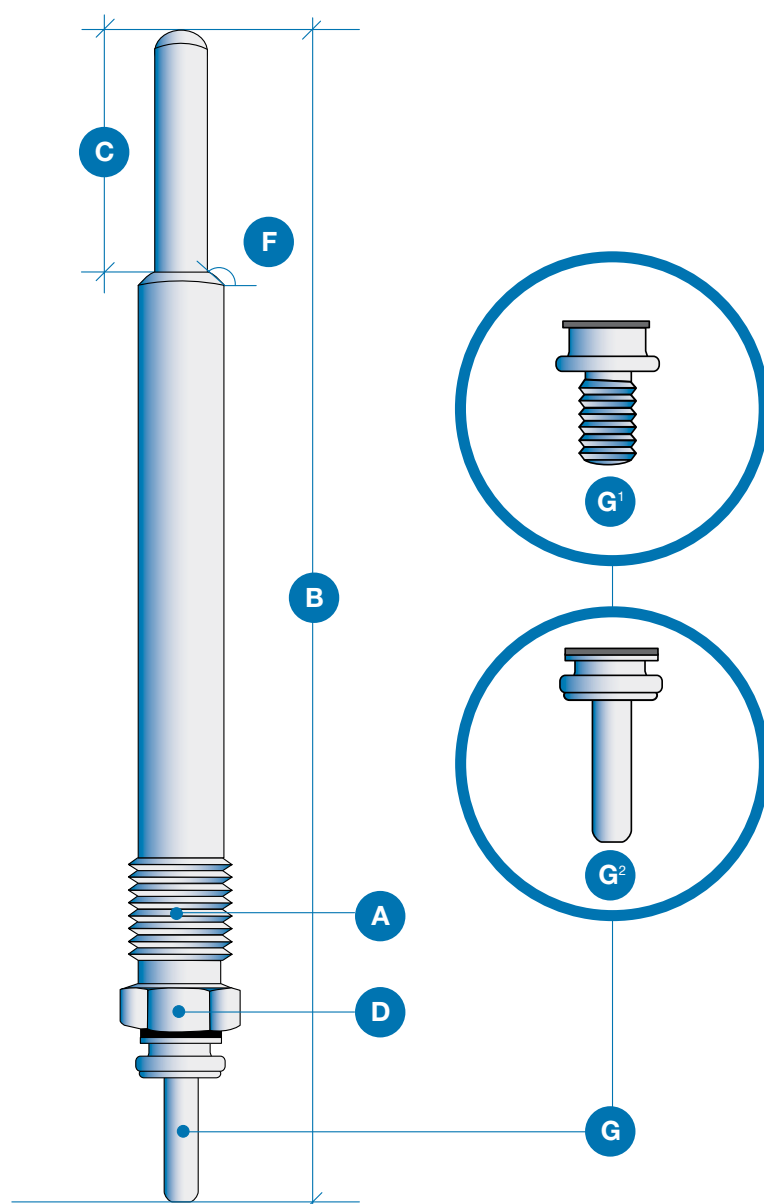

- | | | | | | | |
|---|--|---|--|--|--|--|
| A Thread
Filetage
Gewinde
Rosca
Filettatura
Roscagem
Gwint
Σπειρωμα
Závit
Diş
Navoj
Filet
Вид резьба
Резьба | B Overall length
Longueur totale
Gesamtlänge
Longitud total
Lunghezza totale
Comprimento total
Długość całkowita
Ολικό μήκος
Celková délka
Toplam boy
Ukupna dužina
Lungime totală
Цялостна дължина
Полная длина | C Sheath projection
Crayon
Eintauchtiefe
Protuberancia de la vaina
Lunghezza guaina
Projeção da bainha
Długość trzpienia
Πρόβολος (μύτη)
αντίστασης
Výstupek pláště
Uç boyu
Dužina vrha
Protecția carcasei
Дължина на подгревния елемент
Выступающая часть | D Hexagon
Hexagone
Sechskant
Hexágono
Esagono
Sextavado
Sześciokąt
Εξάγωνο
Šestihran
Anahtar
ölküşü
Šesterokut
Hexagon
Размер на ключа
Шестигранник | E Voltage (V)
Tension (V)
Spannung (V)
Voltaje (V)
Volltaggio (V)
Tensão (V)
Napięcie (V)
Τάση (V)
Elektrické napětí (V)
Voltaj (V)
Napon (V)
Tensiune (V)
Волтаж
Напряжение (V) | F Conical seat
Siège conique
Konischer Sitz
Asiento cónico
Sede conica
Sede cónica
Úszcelnienie stożkowe
Κωνική έδρα
Kuželové sedlo
Konik aç
Konusno ležište
Corp conic
Ъгъл на коничното легло
Коническая фаска | G Type of fit
Type d'embout
Art der Steckverbindung
Tipo de ajuste
Tipo di connessione
Tipo de instalação
Typ podłączenia prądowego
Τύπος εφαρμογής
Typ montáže
Bağlantı tipi
Tip montáže
Typ montării
Тип на свързване
Тип соединения |
|---|--|---|--|--|--|--|





N.B.: See the “Technical Characteristics” chart on the inside of the back cover of the catalogue.

Notes: Voir schéma “caractéristiques techniques” à l’intérieur de la couverture à la fin du catalogue.

Hinweis: Siehe Tabelle “Technische Informationen” auf der Umschlaginnenseite am Katalogende.

Nota: Consulten la tabla “Características técnicas” del interior de la contraportada del catálogo.

N.B.: Consulta la tabella delle caratteristiche tecniche nell’anta interna del catalogo.

N.B.: Consulte a tabela de “Características técnicas” no interior da capa de verso do catálogo.

Uwaga: patrz tabela “informacje techniczne” na stronie wewn’trznej okł[adki katalogu.

Notă : Consultați tabelul cu « Caracteristici tehnice » de pe partea interioară a copertei catalogului

N.B. Προσοχή : Απευθυνθείτε στον πίνακα « Τεχνικά Χαρακτηριστικά » στην εσωτερική σελίδα του οπισθοφύλλου του καταλόγου.

Dodatek: Podívejte se na tabulku “Technické vlastnosti” na vnitřní straně zadní obálky katalogu.

Not: Lütfen “Teknik Özellikler” için bu katalogun arka kapağının içindeki tabloya bakınız.

Napomena: Vidi ilustraciju “Tehnički podatci” na unutrašnjem omotu zadnje strane kataloga.

N.B.: Видж схемата гТехнически характеристики” на вътрешната страна на задната корица на каталога.

ссылка: см. “Технические особенности” в схеме на внутренней части обратной стороны каталога.



EYQUEM



EYQUEM

Federal-Mogul Ignition Products SAS

Rue Joanny Desage - 42140 Chazelles Sur Lyon - France

Phone : +33-(0) 146942719 - Fax : +33-(0) 146942780 - www.eyquem.com